

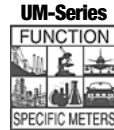

Optional super bright LEDs



Optional Green Digit Display

Optional Custom Faceplate

## UM-35-SG

**Pressure or Load Cell Meter  
3 1/2 DIGIT with 0.56" LEDs  
in a NEMA type 1 Style Case**

**An cost-effective meter to measure 4 wire pressure transducers, strain gauges and load cells. .**

### General Features

The UM-35-SG has two header selectable transducer output ranges of 2mV/V and 20mV/V. Both ranges can provide a full scale display of 2000 counts from the precision ratiometrically compensated 5V or 10V DC excitation provided by the meter. The meter accepts 4 Wire, and like all UM-Series meters, is easily scaled to display in engineering units such as psi, bar, kbar, kpa, feet, lbs, and tons.

### Typical Application Connections

**IS05 : Pressure/Load Cell 2/20mV/V, 5/10V Exc 4-wire**

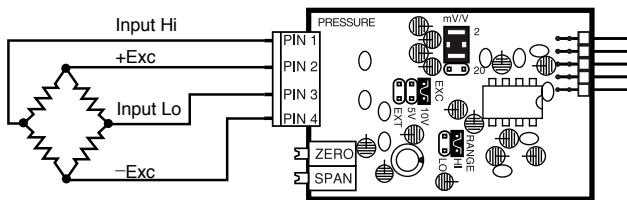

Low Range Adjustment : 0-1000 counts  
Hi Range Adjustment : 1001-1999 counts

### Specifications

- Input Configuration:**.....Differential
- Full Scale Ranges:** .....Accepts inputs from 2mV/V or 20mV/V transducers
- Excitation** .....5V or 10V DC. Ratiometrically compensated to operate with all transducer output ranges.
- A/D Converter:**.....12 Bit Dual Slope
- Accuracy:** .....±(0.05% of reading + 2 counts)
- Temperature Coefficient:** 100 ppm/°C (Typical)
- Warm Up Time:**.....2 minutes to specified accuracy
- Conversion Rate:**.....3 conversions per second (Typical)
- Display:**.....3 1/2 digit 0.56" Red LED display (std), Green or Super Bright Red are optional. Range 0 to 1999 counts.
- Decimal Selection:** .....Header under face plate, X•X•X•X•
- Over-range Indication:**.... 1 (MSD) displayed all other digits blank
- Power Supply (std):**..... 120/240V AC, 50/60/400 Hz. approx 1.5W.  
(Optn) VO-DC/ISO..... Isolated Switcher. 9 to 36V DC/12 to 24V AC
- Operating Temperature:**...-10 to 50 °C
- Storage Temperature:** .....-20 to 70 °C.
- Relative Humidity:**.....95% (non-condensing)
- Case Dimensions:** .....Bezel 3.78"Wx1.89"H (96mm x 48mm)  
Depth behind bezel 3.36" (83.5mm) Plus 0.5 to .9" (12.7 to 22.8mm) depending on connector used.
- Weight:** .....NW. 12oz (0.34kg)  
15.6oz (0.44kg). when packed.

### UM-Series utility meters for switchboard and process indication

- UM-35-ACA** .....AC amps, Scaled or True RMS, (1 or 5 Amp internal shunt), 3.5 digit.
- UM-35-ACV** .....AC volts, Scaled or True RMS. 199.9V AC/700V AC header selectable ranges, 3.5 digit.
- UM-35-DCA** .....DC mV ±20mV/±50mV/ ±100mV/±200mV header selectable ranges, 3.5 digit
- UM-35-DCV** .....DC Volts ±2V/±20V/±200V DC header selectable ranges, 3.5 digit.
- UM-40-ACA** .....AC amps, Scaled or True RMS, (1 or 5 Amp internal shunt), 4.0 digit.
- UM-40-ACV** .....AC volts, Scaled or True RMS. 199.9V AC/700V AC header selectable ranges, 4.0 digit.
- UM-45-DCA** .....DC mV ±20mV/±50mV/ ±100mV/±200mV header selectable ranges, 4.5 digit
- UM-45-DCV** .....DC Volts ±2V/±20V/±200V DC Header selectable ranges, 4.5 digit.

- UM-35-CL** .....Process 4 to 20mA (100.0), easily user scalable in engineering units from -1999 to +1999. 3.5 digit
- UM-35-HZ** .....15Hz to 199.9Hz or optional 40Hz to 400Hz up to 500V AC , 3.5 digit.
- UM-35-Pressure.** Pressure, strain gage and load cell, 4 and 6 wire, 5V DC excitation, Header Selectable Sensitivity 2mV/V, 5mV/V, 10mV/V, 20mV/V, 3.5 digit
- UM-35-JF** .....J thermocouple input, 1° resolution, order °C or °F, 3.5 digit
- UM-35-KF** .....K thermocouple input, 1° resolution, order °C or °F, 3.5 digit
- UM-35-RTD/F.** 100Ω platinum RTD, 3 or 4 wire, order °C or °F and 0.1° or 1°, 3.5 digit
- UM-45-CL** .....Process 4 to 20mA (100.0), easily user scalable in engineering units from -19999 to +19999. 4.5 digit

## Calibration Procedure

1. Select the appropriate position on the INPUT RANGE SELECT Header, to correspond with the mV/V output of the transducer being used.
  2. Connect the transducer to the UM-35-SG as shown in the connection diagram.
  3. With no pressure or load being applied to the transducer, adjust the ZERO pot so that the display reads 000.
  4. Apply a known input, and adjust the SPAN pot until the meter displays the required reading for the pressure or load being applied.
- The UM-35-SG meter is now calibrated and ready for use.

## Decimal Point Selection

Decimal selection is made by moving the jumper to the indicated position on the header for the decimal required on the front of the display board.

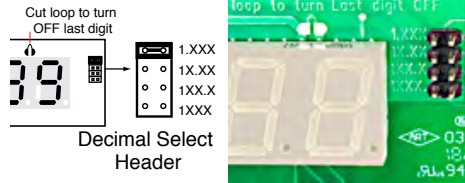

To open meter, insert a flat head screwdriver or similar instrument in both slots on the side of the cover and pry open. The UM-Series meters slide out from the front of the case as a complete assembly.

## Signal Conditioning Components

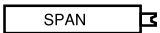

To the Right Front  
Turn Clockwise to Increase Reading

### SPAN Potentiometer (Pot)

The 15 turn SPAN pot is always on the right side (as viewed from the front of the meter). Typical adjustment is 100% of the input signal range.



To the Left Front  
Turn Clockwise to Increase Reading

### ZERO Potentiometer (Pot)

The Optional ZERO pot when installed is always to the left of the SPAN pot (as viewed from the front of the meter). Typically it enables the displayed reading to be offset  $\pm 100$  counts.

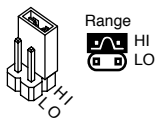

### Span Pot Adjustment Range Header

Low : 0-1000 Counts  
Hi : 1001-1999 Counts

## Optional Face Plate Descriptors

AC	10	kV	kVAR	m/min	Hz	RPM
V	mV	mm	PF	F	G	Coil
DC	100kV	µA	PSIG	mS	µA	psi
kV	W	KWH	pH	%	K	kPa
A	mbar	mA	MW	KA	RPS	MWH
mWs	µm	kw/s	l	l/sec	ml	cm
DRP	mm/s	l/min	mm	kw/sec	lbs	inch
BT	bars	mm	mm	mm	µV	dB

To customize the face plate, clear adhesive label containing various popular descriptors may be ordered. Choose the descriptor desired, peel off the adhesive backing and align the descriptor in the center right of the faceplate.

P.N.: DU-CASEDES

## Component Layout

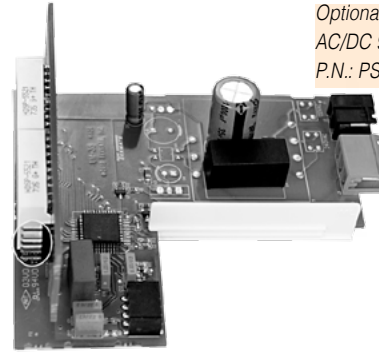

Optional Isolated auto-sensing  
AC/DC 9 to 36V DC / 12 to 24V AC  
P.N.: PS7

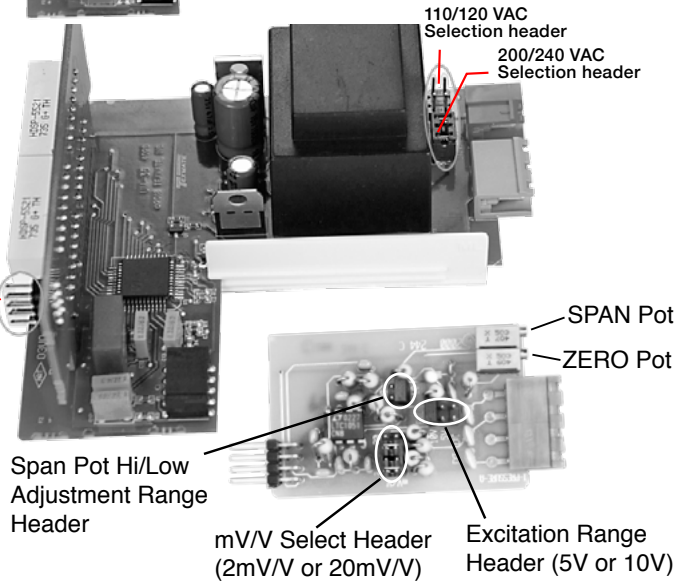

## Connector Pinouts

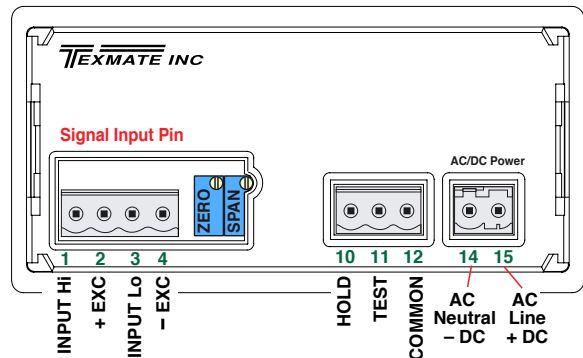

This meter uses plug-in type screw terminal connectors for all connections.

## Connectors

This meter uses plug-in type screw terminal connectors for all input and output connections. The power supply connections (pins 14 and 15) have a unique plug and socket outline to prevent cross connection. The main board uses standard right-angled connectors.

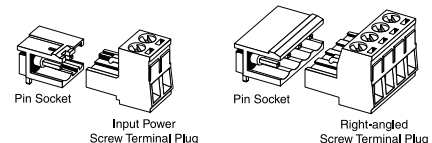

**WARNING:** AC and DC input signals and power supply voltages can be hazardous. Do Not connect live wires to screw terminal plugs, and do not insert, remove or handle screw terminal plugs with live wires connected.

## UM Case Dimensions and Panel Cutouts

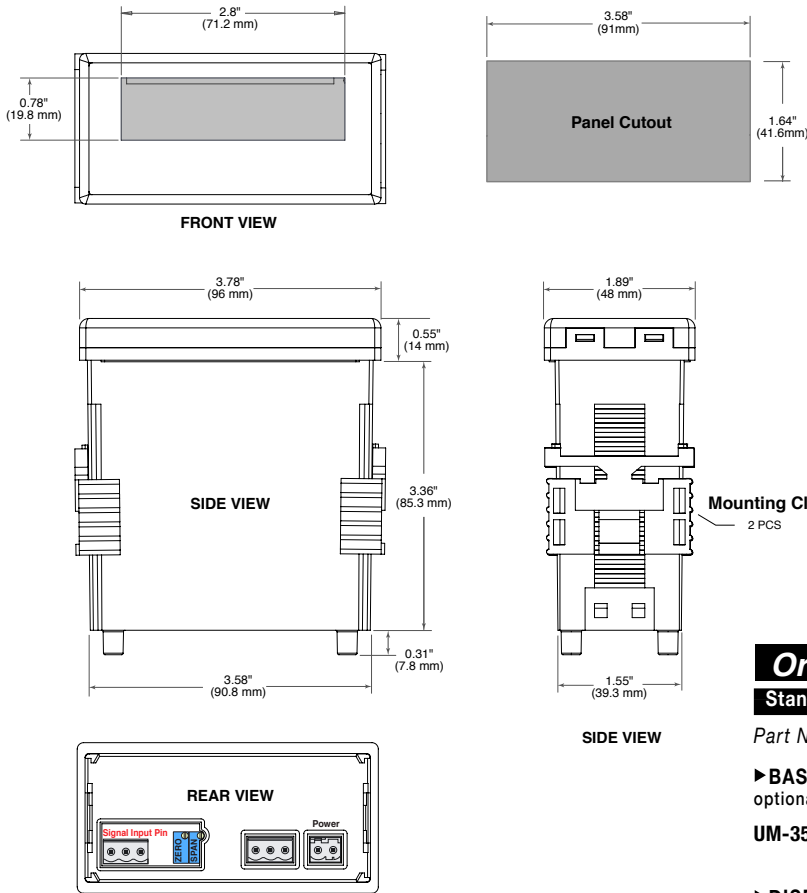

## Clear Lockable Water-proof Cover

The clear lockable cover is designed to be dust and waterproof to NEMA-4X, IP65 standards. The assembly consists of a base and a cover with a cam hinge and key-lock fastening mechanism. An O-ring, or neoprene gasket forms a seal between the base and the panel. The cam hinge prevents the cover from closing when opened until pushed closed. The cover has a tapered recess that, when closed, forms a seal with a tapered spigot on the base. A key-lock employs a cam locking device to force the spigot into the recess, ensuring seal integrity. A safety catch keeps the cover closed even when the key is removed, and the keyhole can be used to attach a safety seal clip, preventing unauthorized opening.

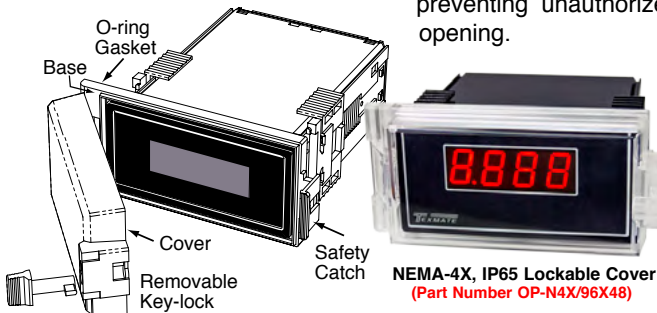

**NEMA-4X, IP65 Lockable Cover**  
(Part Number OP-N4X/96X48)



Contact:  
Industrial Process Measurement, Inc.  
3910 Park Avenue, Unit 7  
Edison, NJ 08820  
732-632-6400  
support@instrumentation2000.com  
http://www.instrumentation2000.com

## Warranty and User's Responsibility

### WARRANTY

Texmate warrants that its products are free from defects in material and workmanship under normal use and service for a period of one year from date of shipment. Texmate's obligations under this warranty are limited to replacement or repair, at its option, at its factory, of any of the products which shall, within the applicable period after shipment, be returned to Texmate's facility, transportation charges pre-paid, and which are, after examination, disclosed to the satisfaction of Texmate to be thus defective. The warranty shall not apply to any equipment which shall have been repaired or altered, except by Texmate, or which shall have been subjected to misuse, negligence, or accident. In no case shall Texmate's liability exceed the original purchase price. The aforementioned provisions do not extend the original warranty period of any product which has been either repaired or replaced by Texmate.

### USER'S RESPONSIBILITY

We are pleased to offer suggestions on the use of our various products either by way of printed matter or through direct contact with our sales/application engineering staff. However, since we have no control over the use of our products once they are shipped, NO WARRANTY WHETHER OF MERCHANTABILITY, FITNESS FOR PURPOSE, OR OTHERWISE is made beyond the repair, replacement, or refund of purchase price at the sole discretion of Texmate. Users shall determine the suitability of the product for the intended application before using, and the users assume all risk and liability whatsoever in connection therewith, regardless of any of our suggestions or statements as to application or construction. In no event shall Texmate's liability, in law or otherwise, be in excess of the purchase price of the product.

Texmate cannot assume responsibility for any circuitry described. No circuit patent or software licenses are implied. Texmate reserves the right to change circuitry, operating software, specifications, and prices without notice at any time.

## Ordering Information

### Standard Options for this Model Number

Part Number	Description	List
-------------	-------------	------

► **BASIC MODEL NUMBER** standard display and standard power supply unless optional versions are ordered.

**UM-35-SG** ..... Pressure/Load Cell **2mV/20mV/V 5/10V Exc 4-wire**  
Input Module : IS05 .....

### ► DISPLAY

**DR** ..... **0.56" Red LEDs** .....

UM-BRIGHT.....Super bright Red LEDs, 0.56 inch high .....

UM-GREEN.....Green LEDs, 0.56 inch high .....

### ► POWER SUPPLY

**PS6** ..... **100/120 or 200/240VAC 60/50Hz User selectable** .....

PS7.....Isolated auto-sensing AC/DC 9 to 36V DC/12 to 24V AC .....

PS8 ..... 5 VDC/200mA .....

### Special Options and Accessories

Part Number	Description	List
-------------	-------------	------

### ► SPECIAL OPTIONS (Specify Inputs & Req. Reading)

ZR.....Input Range Change to another Standard Range .....

ZRS-SMUM.....Non-standard range change and/or Scale change .....

### ► ACCESSORIES

75-DTP2X9624 Panel cutout metal trim plate 96x48mm (2x1/16 DIN & 1/8 DIN) .....

OP-N4X/96X48.96x48mm clear lockable front cover NEMA 4X, splash proof NEMA.RPUM . .Case with sliding mounting clips and dust & splash proof faceplate. ....

ART-NRC-DEC.NRC for Artwork & set-up Custom Faceplate and/or Descriptor

ART-FS1 .....Produce & Install Custom Faceplate per meter - 1 color no-min

ART-FS2 .....Produce & Install Custom Faceplate per meter - 2 color no-min

ART-FS3 .....Produce & Install Custom Faceplate per meter - 3 color no-min

75-DESCRIPTR....Clear adhesive descriptors label for face plate .....

## Custom Face Plates

**Texmate Produces Thousands of Custom OEM Face Plates.** Have Texmate Design and produce a Custom Face Plate for your next project!

• Custom face plates have a non-recurring artwork charge. A serial number is then assigned to each artwork to facilitate reordering.

**UM-35-SG Technical Manual Copyright © 2019 Texmate Inc. All rights reserved. Published by: Texmate Inc. USA. Information in this Technical Manual is subject to change without notice due to correction or enhancement. The information described in this manual is proprietary to Texmate, Inc. and may not be copied, reproduced or transmitted, in whole or in part, in connection with the design, manufacture, or sale of apparatus, device or private label product without the express written consent of Texmate, Inc.**