



STROBOSCOPE Weatherproof IP65

DT-3011J

INSTRUCTION MANUAL

Read this manual thoroughly before use.

Before use, please carefully read these safety precautions as well as instructions,
and follow them for proper operation.

Safety Precautions

Be sure to observe

Be sure to read the entire instruction manual thoroughly before initial set-up, operation and maintenance.

The instruction manual provides two grades of safety warnings: "Danger" and "Caution". Each of them is an important description related to safety. Be sure to observe.



Danger

This indicates the possibility of fire, severe injury, and even death if a user disregards the instruction and operates the unit improperly.



Caution

This indicates the possibility of minor injury or property damage if a user operates the unit improperly. However, depending on the circumstances, there is still the possibility that severe injury may result. Be sure to observe.

We categorize the type of those precautions using the following symbols throughout the manual.



A prohibited action you must not do.



A forced action you must always do.



Danger



Never use in flammable environments.
May result in fire.



Never look directly into the light source.
May result in eye injury



Caution



Do not apply strong impact to the unit, or drop it.
Failure to follow this could result in abnormal operation.



Avoid the followings.
Water, direct sunlight, condensation, dust, dirt, salt, iron, oil, chemicals, corrosive and/or combustible gases



Do not alter, modify or dispose improperly.
Failure to follow this could result in injury due to abnormal operation.



Operate within 0-35°C(32-95°F)
Failure to follow this could result in malfunction.



Wipe clean the unit with a soft dry cloth if it gets dirty. Or immerse a cloth in water diluted neutral detergent, wring it, and wipe clean the unit with it. Do not use any volatile chemicals, such as benzine, thinner, or alcohol.



Operate within 35-85%RH
Failure to follow this could result in malfunction.



Since continuously emitting light for long time causes the unit's housing to heat up, fix the strobe using a tripod, etc. (Avoid direct skin contact with the unit, such as holding it by hand).
Failure to follow this could result in mild burns.

Contents

1	Overview of this product.....	3
2	Before use.....	3
2.1	Checking the supplied items.....	3
3	Part names and functions.....	4
3.1	Main unit	4
3.2	Operation Panel	5
3.3	Display.....	6
3.3.1	Part names and function instructions.....	6
4	Functions and operations.....	7
4.1	Power ON/OFF	7
4.1.1	LAMP ON / OFF.....	8
4.1.2	Flash timer.....	8
4.1.3	Heat Lamp Indicator.....	8
4.2	Emission mode and settings	9
4.2.1	How to switch INT and EXT	9
4.3	Internal oscillation emission.....	10
4.3.1	FPM mode setting (INT)	10
4.3.2	PHA mode (INT).....	12
4.4	External synchronous emission	13
4.4.1	FPM mode setting (EXT).....	14
4.4.2	PHA mode setting (EXT).....	15
4.5	Divide ratio setting (only for EXT).....	16
4.5.1	Divide ratio.....	16
4.5.2	Divide ratio setting.....	16
4.6	Function mode.....	17
4.6.1	The setting items	17
4.6.2	Instructions about function mode.....	17
4.7	Saving function	21
4.7.1	Saving the setting values	21
4.7.2	Initialize	22
4.7.3	Initializing the setting values.....	23
4.8	External signal I/O connector specifications and Pin assignment	24
4.9	External pulse input.....	25
4.10	Lamp replacement.....	26
5	Specifications.....	27
5.1	Specifications list.....	27
5.2	External dimensions.....	28
6	Troubleshooting	29

1 Overview of this product

A stroboscope tachometer is a measurement instrument to measure the speed (cycle) of rotating objects that rotate at a constant speed, or moving objects that repeatedly operate at a constant cycle. When the rotation (motion) cycle matches with the flash cycle while the strobe flash is periodically applied on a rotating or moving object, the rotating (moving) object image appears to stand still. This stroboscope tachometer is the non-contact type, and can be used to read the object frequency when such a still image appears. Also, a stroboscope can be used to make images of rotating or moving objects stand still or that slightly move in order to observe their appearance in slow-motion.

Main features

- Wide flash range – 200 to 2500 FPM (flashes per minute)
- Emission in synchronization with the external trigger pulse
- Phase Shift function. (PHA mode)
- Sealed structure to prevent water and dust from entering.

2 Before use

2.1 Checking the supplied items

Check that the four items below are supplied.

	DT-3011J
Main unit	One (1) DT-3011J 
Accessories	One (1) Power cable (9m)
Instruction Manual	One (1) This document
Warranty	One (1) document

3 Part names and functions

3.1 Main unit

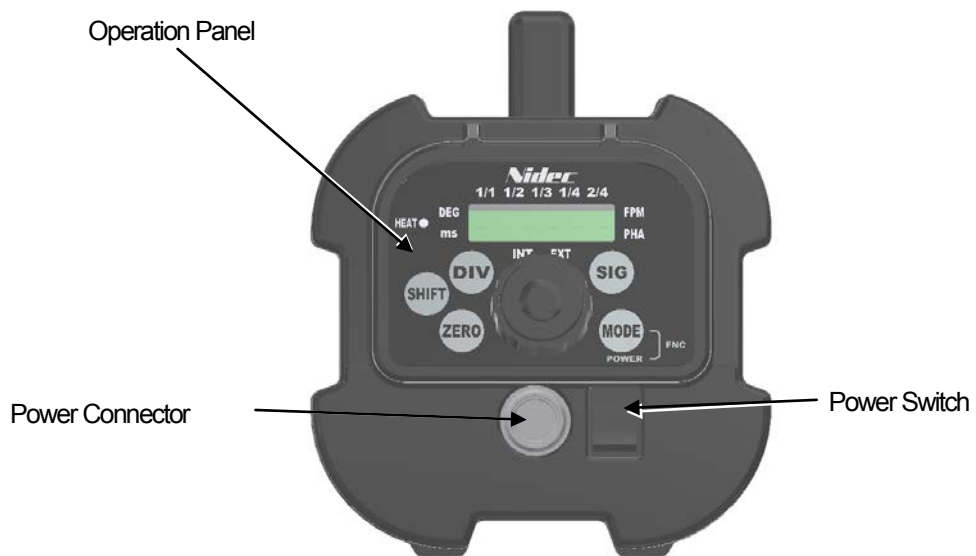
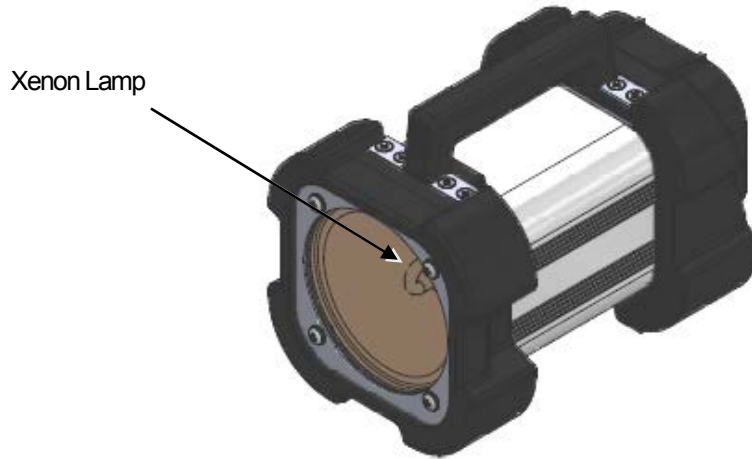

3.2 Operation Panel

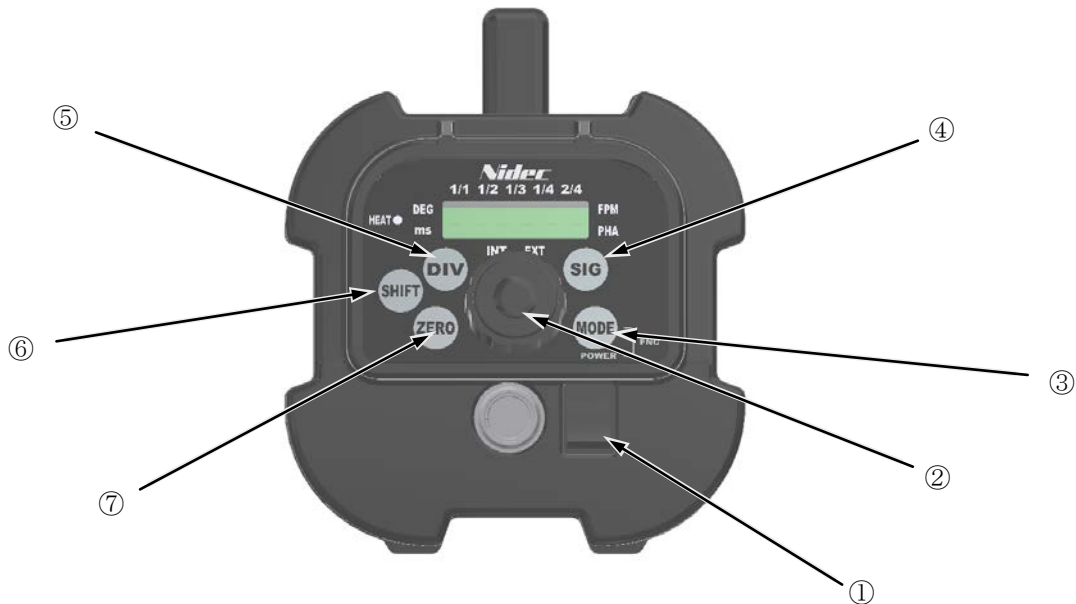

No.	Key	Function Instructions
①	Power Switch	Turns the power ON/OFF
②	Dial (LAMP POWER)	Turn this clockwise or counterclockwise to change the emission frequency and some setting value. Press and hold the center of this to turn the lamp ON/OFF.
③	MODE	Press this to switch the LED display as follows Flashes Per Minute mode (FPM mode) → Phase Shift mode (PHA mode DEG = delay angle) → Phase Shift mode (PHA mode ms = delay time) → FPM mode →...
④	SIG	Select Internal/ External/ Parameter mode. Internal oscillation emission (referred to as "INT"): Flash by internal signal External synchronous emission (referred to as "EXT"): Synchronized flash with external signal
⑤	DIV	Press this while on EXT to change light emission cycle as follows 1/1⇒1/2⇒1/3⇒1/4⇒2/4. (Divided ratio)
⑥	SHIFT	Press this while the emission frequency is divided to delay the emission timing by one pulse.
⑦	ZERO	Press this while on "EXT PHA mode (DEG)" to set the angle displayed on the LED to "0". To turn it back to the original setting, set the time to 0.0 [ms] while on "PHA mode (ms)" and then press "ZERO" button, or reset the unit.

3.3 Display

3.3.1 Part names and function instructions

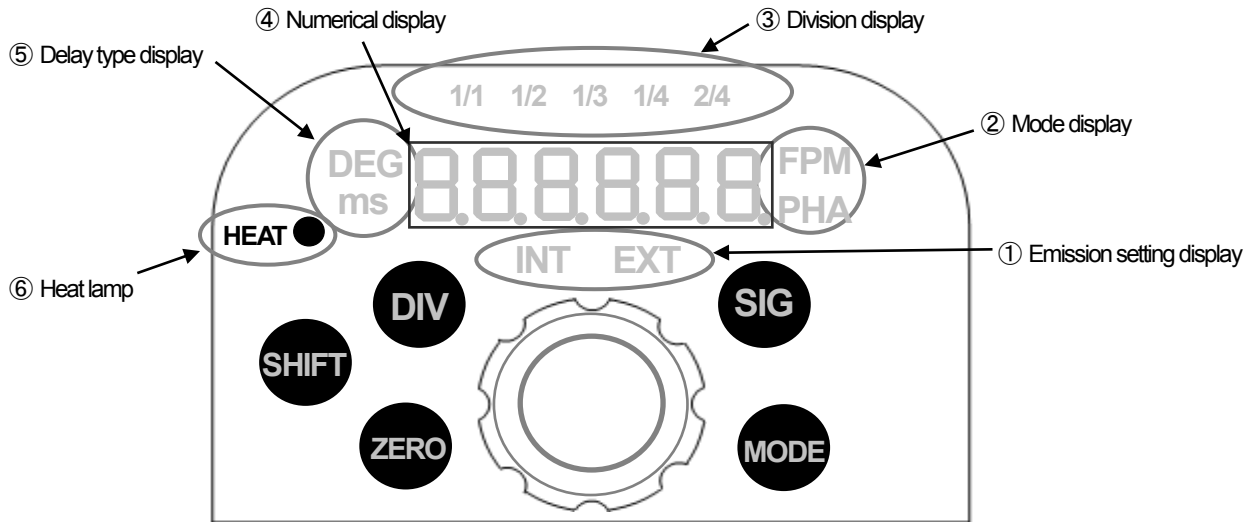





No.	Key	Display	Instructions
①	Emission setting display	INT	Each press of "SIG" switches emission settings: INT : Internal oscillation emission EXT : External synchronous emission
		EXT	
②	Mode display	FPM	Each press of "MODE" switches flashing mode and delay type: FPM : Flashes per minutes mode PHA : Phase mode
		PHA	
③	Division display	1/1 1/2 1/3 1/4 2/4	Each press of "DIV" switches light emission cycle.
④	Numerical display		Standard Operation: indicates flash rate. PHA Mode: Angle and Time are displayed Function Mode: Each setting value is indicated
⑤	Delay type display	DEG	Each press of "MODE" switches flashing mode and delay type. DEG : delay angle ms : delay time (millisecond)
		ms	
⑥	Heat Lamp	HEAT	When the ambient temperature of the Xenon lamp rises above a certain level, this lamp indicator will flash.

4 Functions and operations

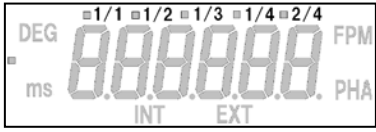

4.1 Power ON/OFF

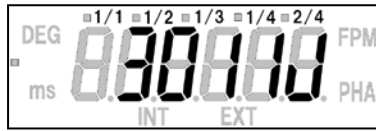
Press the power switch when the power is OFF to turn the power ON.

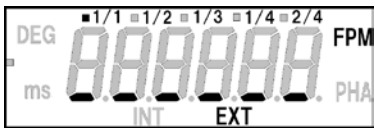
When power is turned ON, the model is indicated, followed by internal oscillation emission or external synchronous emission.

Operation	Display
When the power is OFF	   <p>Displayed "dt" for 0.5 sec.</p>
Press the power switch	 <p>Displayed the model for a sec.</p>   <p>When turning the power on for the first time, "EXT FPM mode" is displayed. From the second time on, the same as when the power is previously turned OFF is displayed.</p>

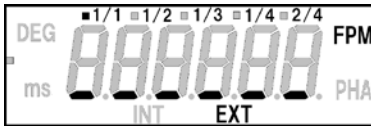

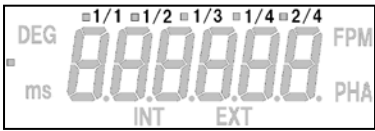

Press the power switch when the power is ON to turn the power OFF, then the indication goes off.

Operation	Display
When the power is ON	   <p>Indicated letters go off</p>

*When the power is turned ON, the following indication may be displayed.

The following indication is an error message when the reading previously used setting value fails.

Press the "MODE" to return to normal emission screen from the error message display.

Operation	Display
 <p>Press the "MODE"</p>	 <p>Error message</p>   <p>Returns to the normal emission screen</p>

4.1.1 LAMP ON / OFF



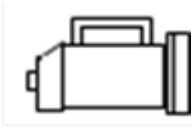

Press and hold the center of the dial to turn ON the LAMP when emission setting is displayed on the screen.
 Press and hold again while flashing to turn OFF the LAMP.

Operation	Display
 <p>Press and hold</p>	 <p>Press and hold the dial to flash. Press and hold again to stop flashing.</p>

*When turning the power switch OFF while flashing, it will be turned ON flashing at the next time.

4.1.2 Flash timer

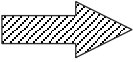
The flashing will automatically cease after 30 minutes from the start of the light emission.
 When the flashing stops by this flash timer, the display indicates "OFF".
 Press and hold the dial to return to the previous display.

Operation	Display
 <p>Press and hold</p>	 <p>After 30 minutes from the start</p>   <p>Return to the previous display</p>

4.1.3 Heat Lamp Indicator

When the ambient temperature of the Xenon lamp rises above a certain level, the Heat Lamp Indicator will flash.
 If the temperature rises more, the Heat Lamp Indicator will remain on and the light emission will cease.

* The temperature tends to rise easily when the emission frequency is higher.

The ambient temperature of the Xenon lamp	HEAT	Light emission
Less than 75°C (164°F)	Off	Keep flashing
Over 75°C (167°F)	Flash	Keep flashing
Over 80°C (176°F)	On	Stop flashing

4.2 Emission mode and settings

Emission mode	詳細
Internal oscillation emission ("INT")	Flash at the set frequency.
External synchronous emission ("EXT")	Flash in synchronization with an external trigger pulse input.
Function mode	Configure the settings.

4.2.1 How to switch INT and EXT

Each press of "SIG" switches "INT" and "EXT".

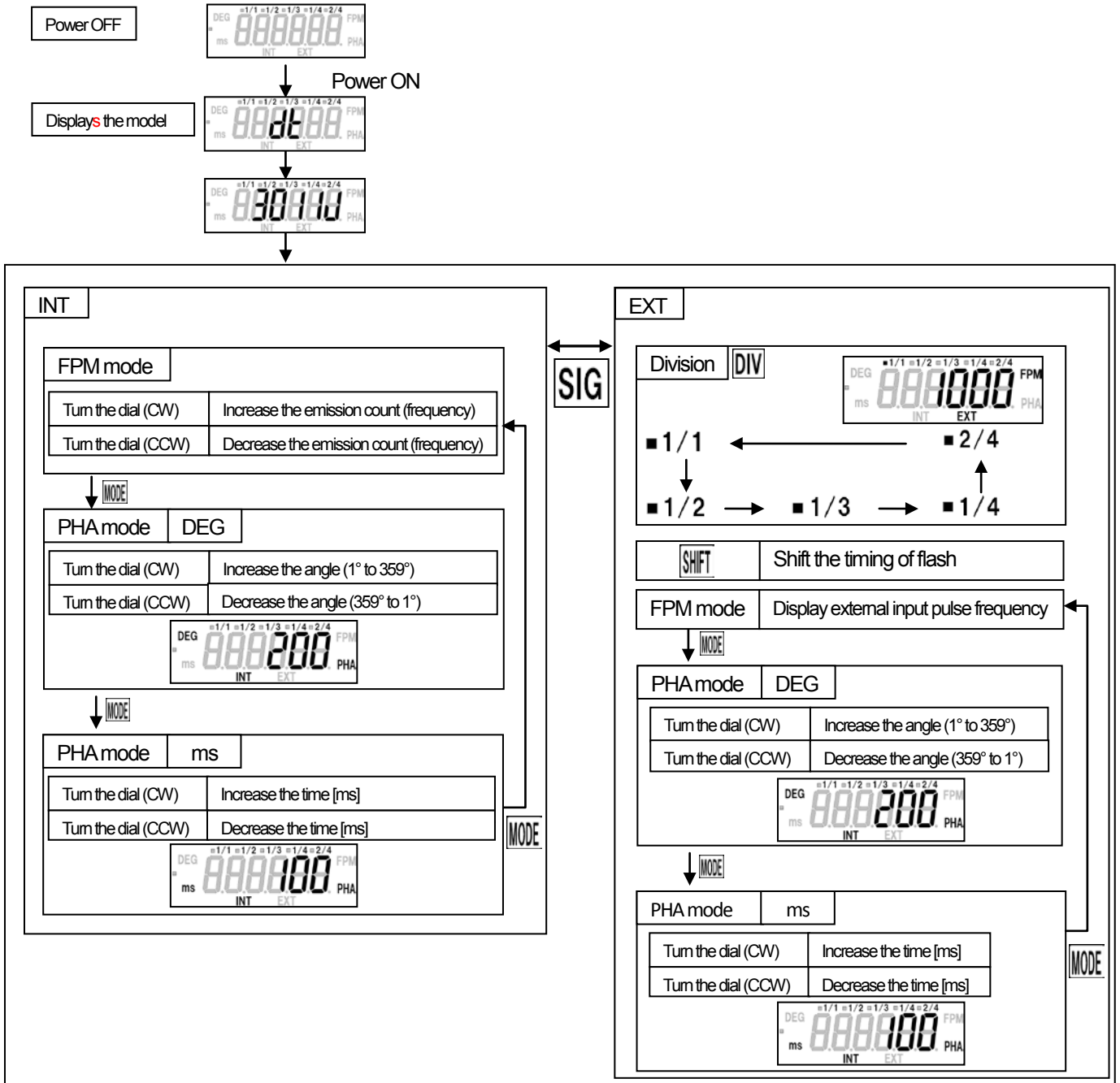

4.3 Internal oscillation emission

- On "INT", the Xenon lamp flashes at the displayed emission value.
- "INT" has the following 2 mode settings.

Mode settings	FPM mode	PHA mode
Instructions	Set the emission count per minute [FPM] (flashes per minute)	Shift the timing of flash. The phase can be changed by a degree or a millisecond. (One cycle is 360°)

Display of INT

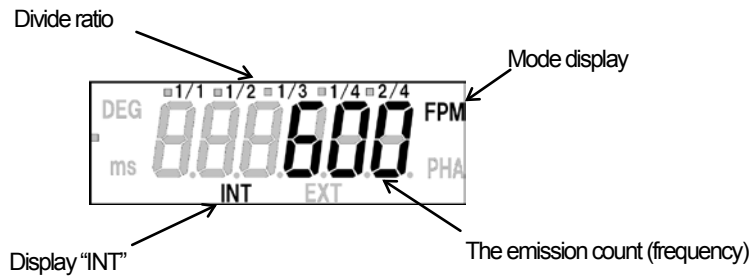



4.3.1 FPM mode setting (INT)

The emission count (frequency) can be set in FPM mode.

Turn the dial in a CW direction to increase the emission count, and in a CCW direction to decrease it.

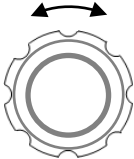
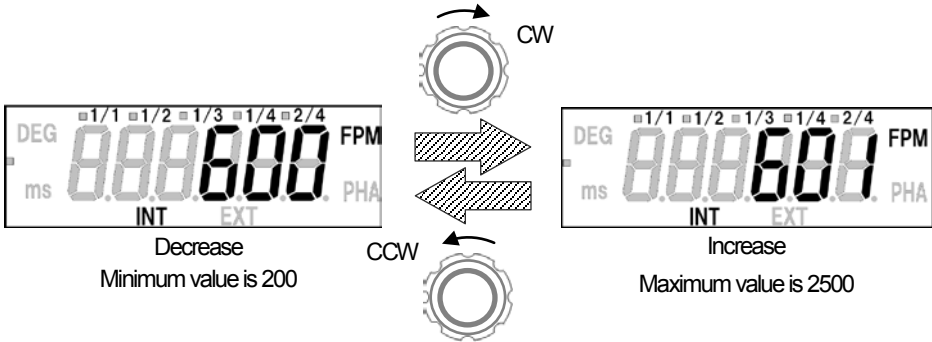
(Turn the dial fast to change the setting value greatly, and slowly to change it slightly.)

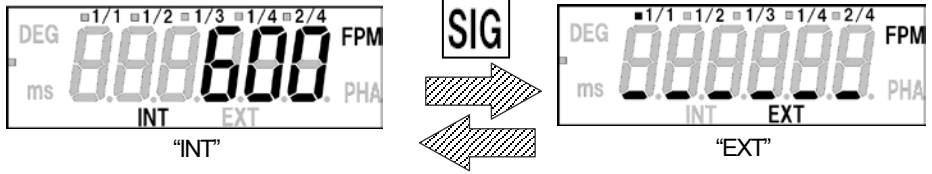
Operation	Display
 <p>Increase / decrease the emission value (frequency)</p>	 <p>Decrease Minimum value is 200</p> <p>Increase Maximum value is 2500</p>
 <p>Press "SIG" to switch to the "EXT"</p>	 <p>"INT"</p> <p>"EXT"</p>

MODE

Press "MODE" to
switch to PHA mode
(DEG)

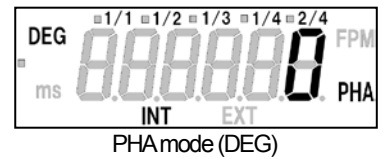
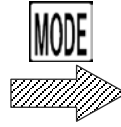
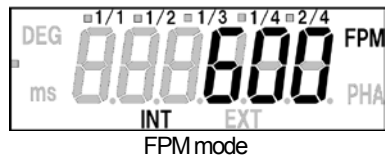

4.3.2 PHA mode (INT)





When the rotation (motion) cycle of a measured object matches with the strobe flash cycle, the measured object appears to stand still. **Use the PHA mode in order to adjust the stop angle (position).**

The phase can be changed by 1° using dial within the range between 1° and 359° in the PHA mode.

Press "MODE" to switch to PHA mode (ms). (The phase can be changed by 0.1[ms] within the range between 0.0 and 299.2 [ms].)

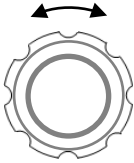
A time longer than the light emission cycle cannot be set. (PHA mode ms)

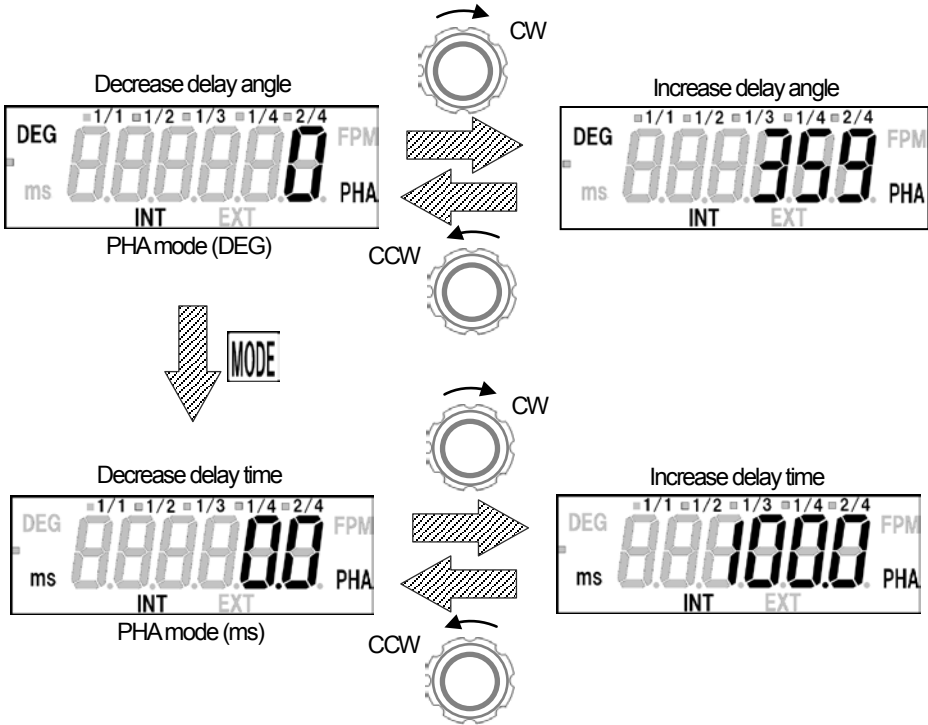
Press "MODE" in PHA mode (ms) to switch to FPM mode.

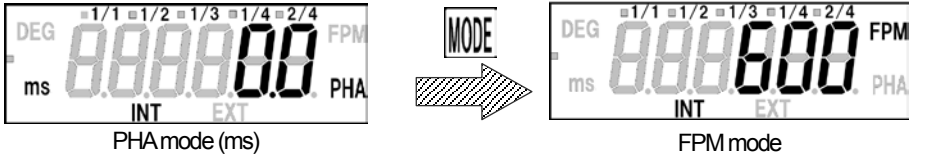
Operation	Display
 <p data-bbox="229 846 443 904">Increase / decrease Delay angle / time</p>  <p data-bbox="197 1151 475 1209">Press "MODE" to switch to PHA mode (ms)</p>	 <p data-bbox="612 667 810 694">Decrease delay angle</p> <p data-bbox="1171 672 1369 698">Increase delay angle</p> <p data-bbox="619 828 788 855">PHA mode (DEG)</p> <p data-bbox="612 1057 810 1084">Decrease delay time</p> <p data-bbox="1171 1061 1369 1088">Increase delay time</p> <p data-bbox="628 1214 794 1240">PHA mode (ms)</p>
 <p data-bbox="197 1456 475 1514">Press "MODE" to switch to FPM mode</p>	 <p data-bbox="628 1473 794 1500">PHA mode (ms)</p> <p data-bbox="1193 1478 1299 1505">FPM mode</p>

4.4 External synchronous emission

- External synchronous emission is the function to emit a strobe flash in synchronization with an external trigger pulse input.
- You can set which edge of the external trigger pulse triggers emission, the rising edge or falling edge.
- A timing (delay) from the external trigger pulse input with the strobe flash emission can be optionally set using time and angle.
- EXT has the following 2 mode settings.

Mode setting	FPM mode	PHA mode
Instruction	Display the measured value of the emission count (frequency). The unit is FPM (flashes per minute)	Shift the timing of flash. The phase can be changed by a degree or a millisecond. (One cycle is 360°)

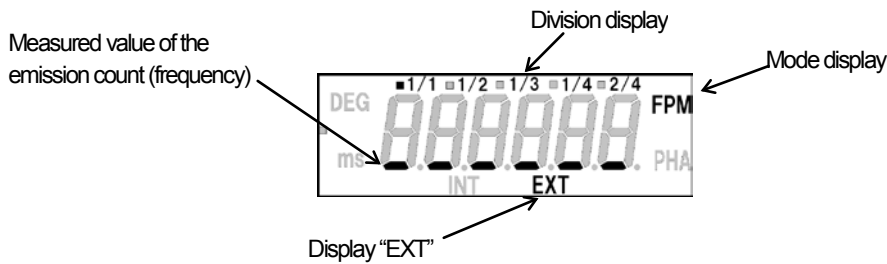

*If the external trigger pulse cycle is beyond the specifications range, the following letters are indicated.

[Without the delay angle / time setting]

Measurable range 180 to 2750 [fpm]



When the external input pulse frequency goes below 180 [fpm], underlines are displayed.

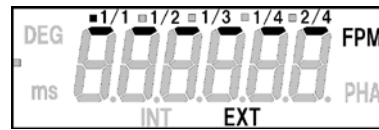

When the external input pulse frequency goes beyond 2750 [fpm], overlines are displayed.

[With the delay angle setting]

Measurable range 180 to 2750 [fpm]



When the external input pulse frequency goes below 180 [fpm], an underline on the first, left two digits is displayed.



When the external input pulse frequency goes beyond 2750 [fpm], an overline on the first, left two digits is displayed.

[With the delay time setting]

Measurable range 180 to 2750 [fpm]



When the external input pulse frequency goes below 180 [fpm], an underline on the first, left two digits is displayed.



When the external input pulse frequency goes beyond 2750 [fpm], an overline on the first, left two digits is displayed.

4.4.1 FPM mode setting (EXT)

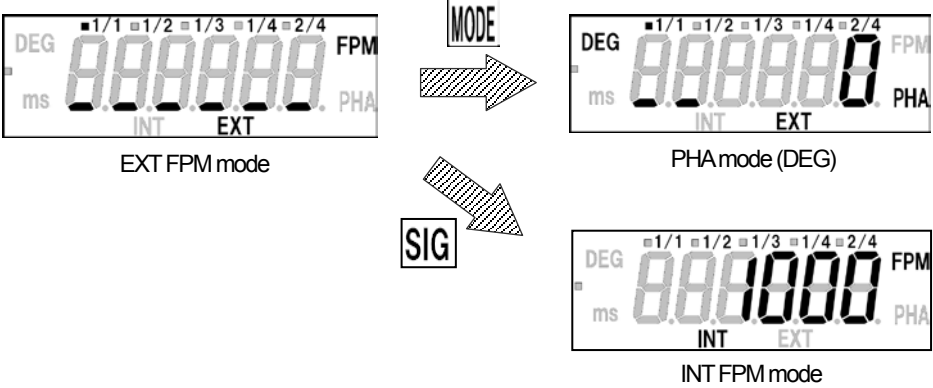
Operation	Display
<p data-bbox="300 427 371 495">MODE</p> <p data-bbox="193 521 467 584">Press "MODE" to switch to PHA mode (DEG)</p> <p data-bbox="300 618 371 685">SIG</p> <p data-bbox="193 707 467 770">Press "SIG" to switch to INT</p>	 <p data-bbox="632 566 783 593">EXT FPM mode</p> <p data-bbox="1182 566 1350 593">PHA mode (DEG)</p> <p data-bbox="1193 779 1339 806">INT FPM mode</p>

4.4.2 PHA mode setting (EXT)

Delay emission can be set within the input signal range between 180 and 2750[μpm].

In the PHA mode, the phase from the external trigger pulse entry to strobe flash emission can be changed by 1° using the dial within the range between 1° and 359°.







Press "MODE" to switch to PHA mode (ms).

The phase can be changed by 0.1 [ms] within the range between 0.0 and 332.4 [ms].

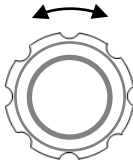
A time longer than the light emission cycle cannot be set. (PHA mode ms)

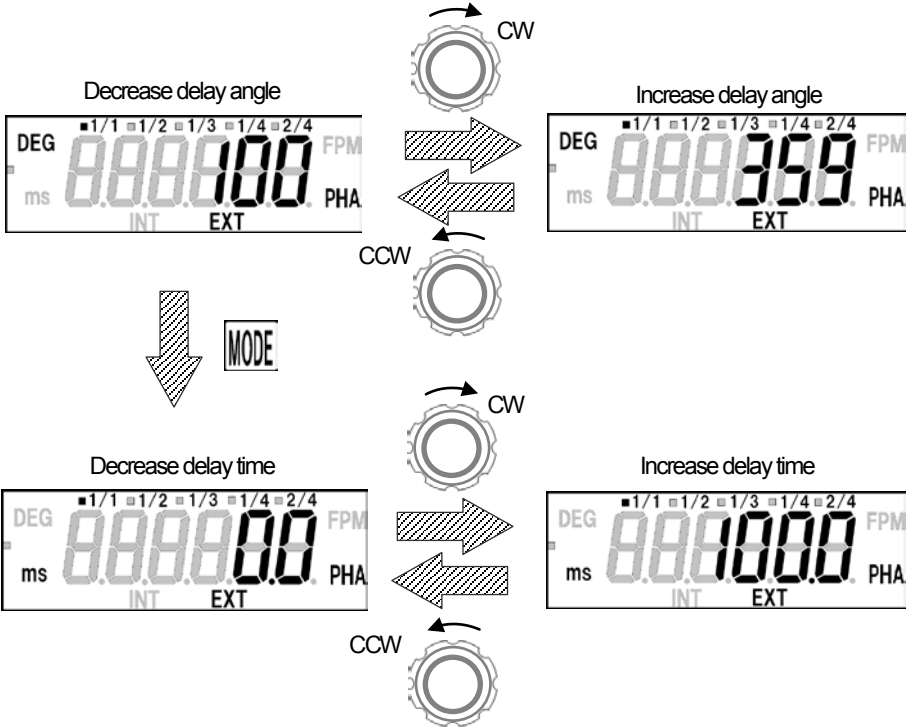
Press "ZERO" to set the displayed angle to "0". (PHA mode DEG)

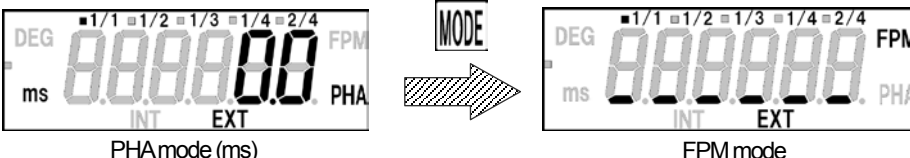
Press "MODE" in PHA mode (ms) to switch to FPM mode.

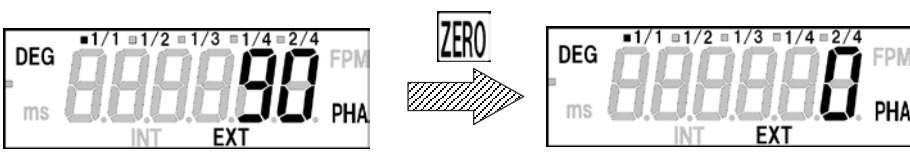
Operation	Display
 <p data-bbox="225 920 440 981">Increase / decrease Delay angle / time</p>  <p data-bbox="185 1196 464 1256">Press "MODE" to switch to PHA mode (ms)</p>	 <p data-bbox="619 748 823 779">Decrease delay angle</p> <p data-bbox="1171 748 1375 779">Increase delay angle</p> <p data-bbox="624 1122 820 1153">Decrease delay time</p> <p data-bbox="1176 1122 1372 1153">Increase delay time</p>
 <p data-bbox="185 1532 464 1592">Press "MODE" to switch to FPM mode</p>	 <p data-bbox="644 1599 799 1630">PHA mode (ms)</p> <p data-bbox="1219 1599 1326 1630">FPM mode</p>
 <p data-bbox="185 1800 480 1906">Press "ZERO" to set the displayed angle to "0" (Only for EXT)</p>	 <p data-bbox="1235 1890 1342 1921">Display "0".</p> <p data-bbox="1098 1921 1442 1953">The emission timing remains delayed.</p>

4.5 Divide ratio setting (for EXT)

4.5.1 Divide ratio

Flash as follows in accordance with the divide ratio.

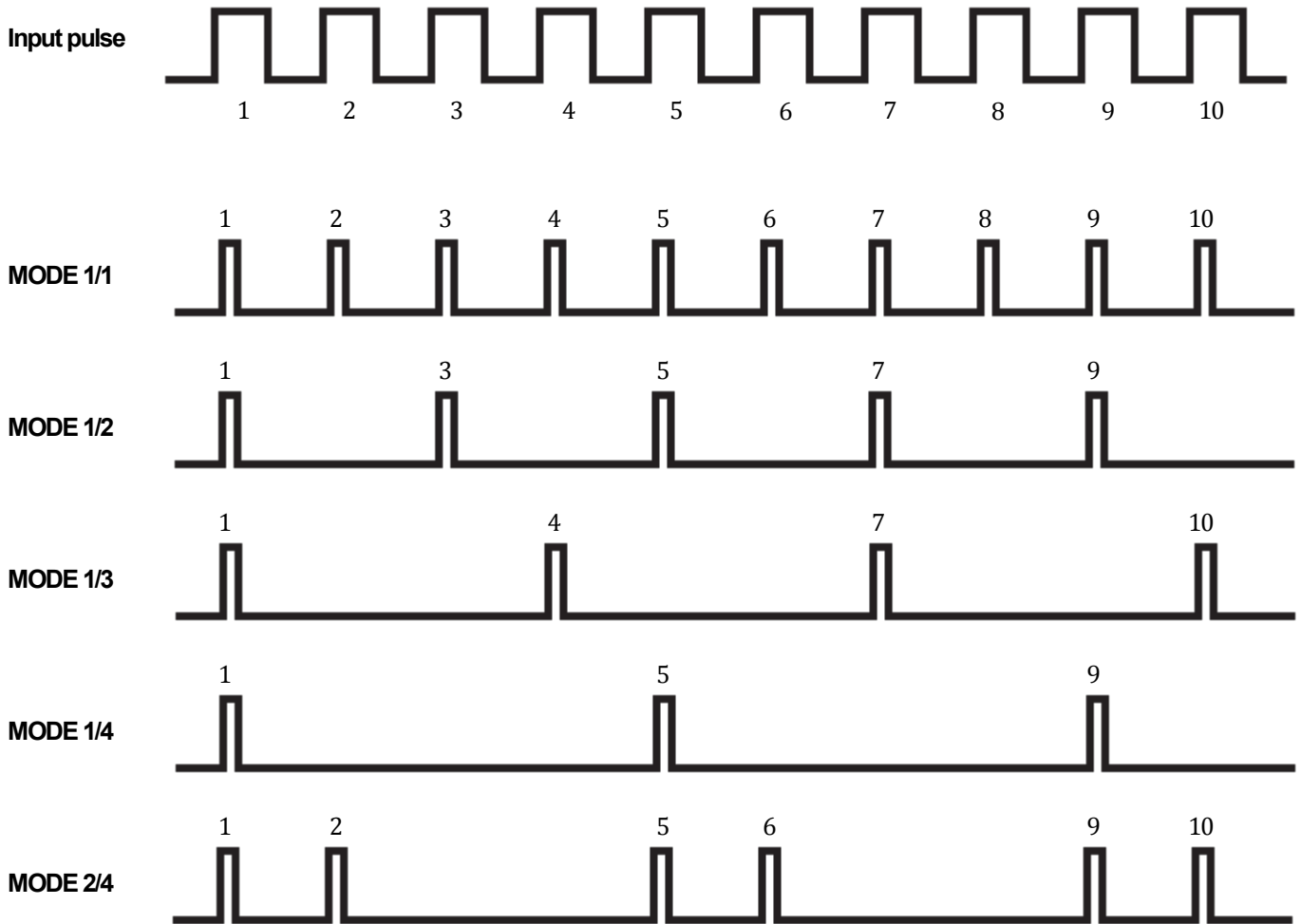

4.5.2 Divide ratio setting

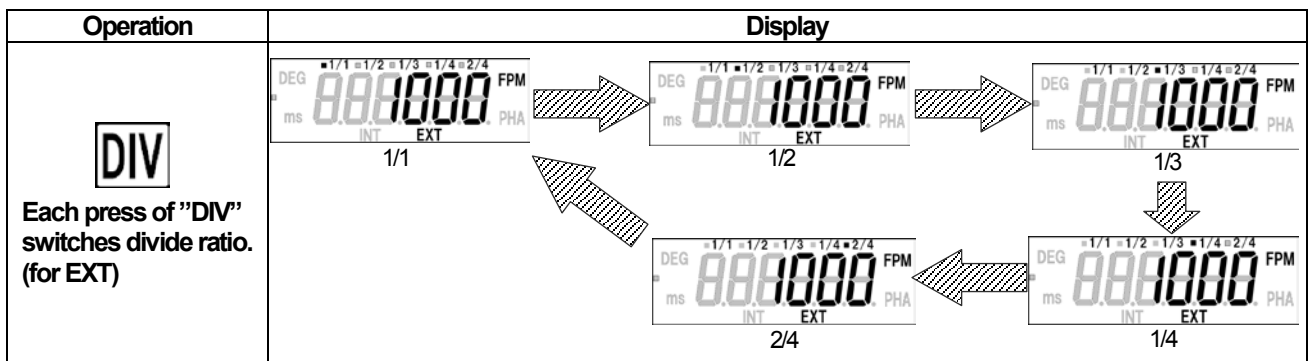

4.6 Function mode

Turn the power ON while pressing the “MODE” to enter the function mode.

During the function mode, turn the dial (CW/CCW) to change the settings.

And press “MODE” to save the setting and move to the next setting item. (F1⇒F2⇒F3 end)

If the power is turned OFF in the middle of the function mode, the changed value will not be saved in the memory.

4.6.1 The setting items

The setting items in the following table can be configured in the function mode.

F1	Trigger edge setting (for EXT)
	Flash in the rising edge.
	Flash in the falling edge.
F2	Choose the input circuit
	Open collector input
	Voltage pulse input
F3	Measurement range setting (for INT)
	The maximum value of the emission count can be set within the range between 200 and 2500 [fpm] (The value is limited to the maximum.)





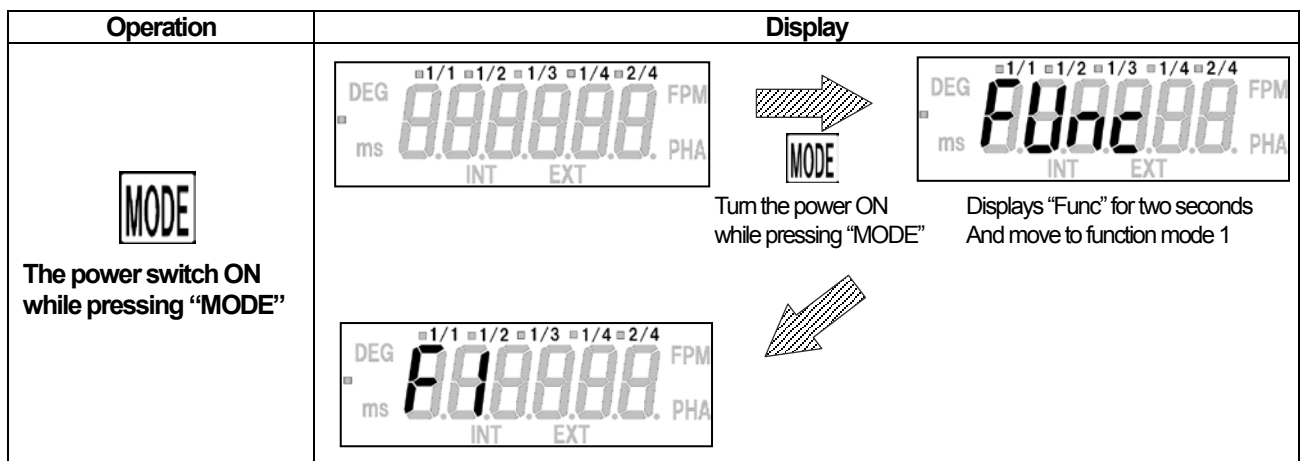

4.6.2 Instructions about function mode

How to move to function mode.

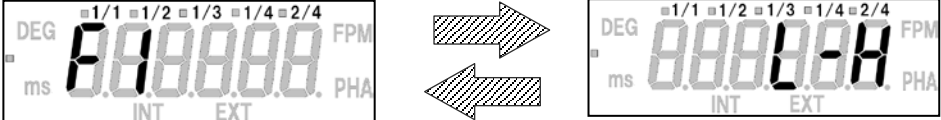
Turn the power ON while pressing the “MODE” to enter the function mode.

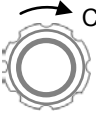

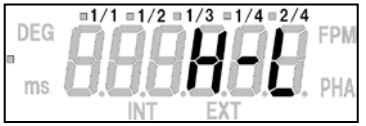

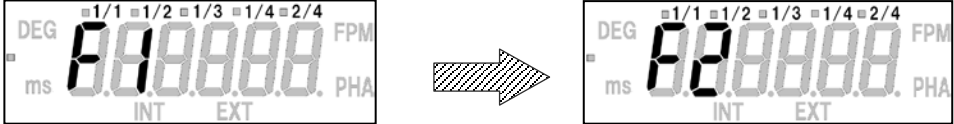

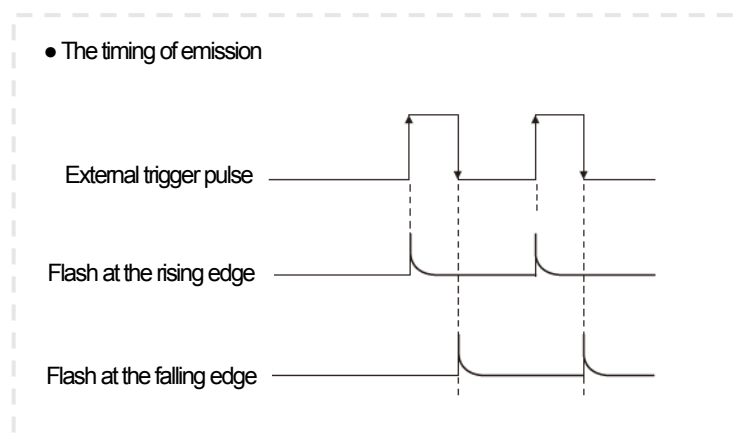

In function mode 1, in which the edge of the external pulse triggers emission, the rising edge or falling edge, can be set (for EXT).

Operation	Display
 <p>Change the setting value</p>	<p>Indicates alternately</p>  <p>Turn the dial and it will stop indicating alternately.</p>  <p>CCW</p>  <p>CW</p>  <p>CCW: L-H (Rising edge)</p>  <p>CW: H-L (Falling edge)</p> <p>*Previous setting value The default setting is "L-H"</p>
 <p>Go to function mode 2</p>	 <p>Go to function mode 2</p>

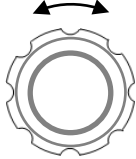
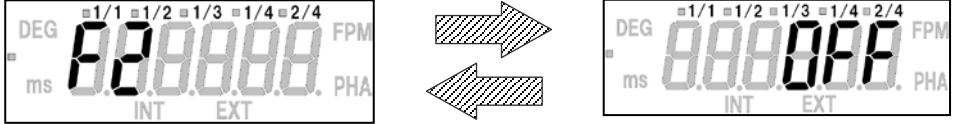





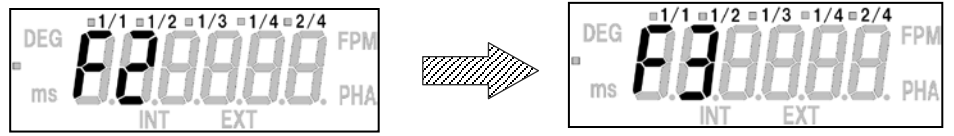

*This setting changes the timing of emission as shown in the following figure.

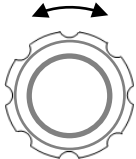
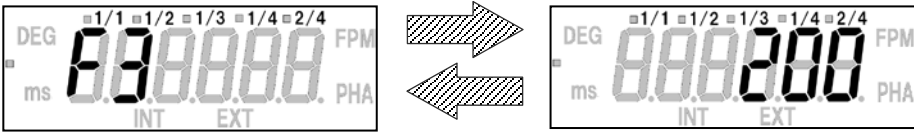

In function mode 2, the input circuit setting can be changed.

Operation	Display
 <p>Change the setting value</p>	<p>Indicates alternately</p>  <p>*Previous setting vale The default setting is "OFF"</p> <p>Turn the dial and it will stop indicating alternately.</p> <p>CCW</p>   <p>CCW : OFF Voltage pulse input (Pull down the external input circuit)</p> <p>CW</p>   <p>CW : On Open collector input (Pull up the external input circuit)</p>
 <p>Go to function mode 3</p>	 <p>Go to function mode 3</p>

In function mode 3, the measurement range on INT can be set.

Operation	Display
 <p>Change the setting value</p>	<p>Indicates alternately</p>  <p>*Previous setting vale The default setting is "2500"</p> <p>Turn the dial and it will stop indicating alternately.</p>  <p>CCW  CW </p>  <p>Increase / decrease by 1 [fpm] Available setting range: 200 to 2500 [fpm]</p>
 <p>Save the changes and go to the home screen</p>	  <p>Go to the home screen</p>

4.7 Saving function

While using the unit while on INT and EXT, turn the power OFF to save the setting value to that which it was before turning the power OFF.

When the power is turned ON again, operation starts from the previous setting value.

4.7.1 Saving the setting values

When the power is OFF, the setting values are saved as the following figure.







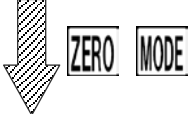

○: save ×: cannot save		Power OFF	
		During INT	During EXT
Emission setting (INT/EXT)		○	○
Mode setting (FPM/PHA)		○	○
INT	The emission count (FPM)	○	×
	Delay angle (PHA)	○	×
	Delay time (PHA)	○	×
EXT	Delay angle (PHA)	×	○*1
	Delay time (PHA)	×	○*2
	Divide ratio (DIV)	○	○

*1 When you press "ZERO" in Delay angle mode, the value (delay angle) on the display is different from the actual value.
In that case, the value on the display will be saved.

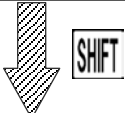
*2 When you turn the power OFF to save, the calculated delay time based on delay angle will be saved.

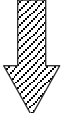
4.7.2 Initialize

The memory can be erased by initializing the saving function.

Operation	Display
<p data-bbox="240 636 405 703">ZERO MODE</p> <p data-bbox="188 719 432 804">The power switch ON while pressing "ZERO" and "MODE"</p> <p data-bbox="285 1039 352 1099">SHIFT</p> <p data-bbox="188 1126 387 1182">Press "SHIFT" and confirm initialization</p>	<div style="text-align: center;">  </div> <p data-bbox="1177 521 1406 607">The power switch ON while pressing "ZERO" and "MODE"</p> <div style="text-align: center;">  </div> <div style="text-align: center;">  </div> <p data-bbox="1177 786 1382 846">Press "SHIFT" and Confirm initialization</p> <div style="text-align: center;">  </div> <div style="text-align: center;">  </div> <p data-bbox="1177 931 1401 965">Displays for a second</p> <div style="text-align: center;">  </div> <div style="text-align: center;">  </div> <p data-bbox="1177 1167 1469 1227">Displays for a second And go to the home screen</p> <div style="text-align: center;">  </div> <div style="text-align: center;">  </div>

4.7.3 Initializing the setting values

The current settings will be erased and replaced as follows. (Including the function mode.)

		The initial setting	display
The initial emission setting		EXT	
The initial mode		PHA	
INT	FPM	600	
	PHASE(DEG)	0	
	PHASE(ms)	0	
EXT	FPM	0	*
	PHASE(DEG)	0	
	PHASE(ms)	0	
F1		L-H	
F2		OFF	
F3		2500	

* On EXT, underlines are displayed until the external signal inputs occur.

4.8 External signal I/O connector specifications and Pin assignment

RM15WTRZB-10P (71) (Hirose Electric Group)

Pin number	Signal name	Remarks
1	+	Power supply (+)
2	-	Power supply(-)
3	NC	-
4	NC	-
5	IN	External pulse input
6	COM	GND
7	NC	-
8	NC	-
9	FG	Earth
10	FG	Earth

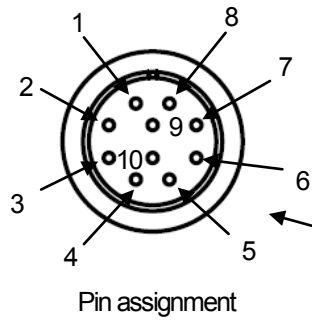

4.9 External pulse input

Connect the unit to external devices (sensors, etc.) to allow the strobe to emit light using the pulse signal from the devices on external synchronous emission.

Available input frequency	:	Available measurement range	180 to 2750 fpm (3.0 to 45.8 Hz)
	:	Available delay emission range	180 to 2750 fpm (3.0 to 45.8 Hz)
Available input signal	:	Hi	5 to 24 V
	:	Lo	0 to 1 V
Available input pulse width	:		2 ms or more (edge trigger)
Input impedance	:		47 k Ω (at voltage input)

[Input circuit]

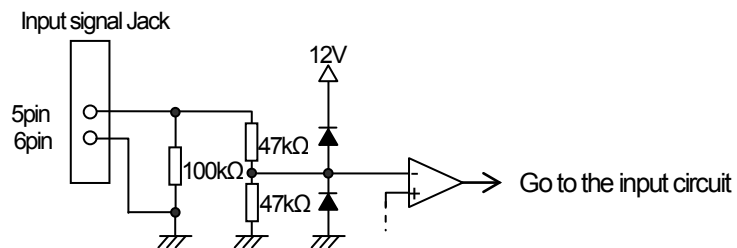

4.10 Lamp replacement

Lamp life is about 100 million flashes. Although rotation speed is displayed, no flash is emitted. When the flash is intermittently emitted, this indicates the lamp must be replaced. Be sure to replace the lamp with the following steps. Be sure to use the specified lamp. Please contact us or the retailer where you purchased this product if you need it.



The lamp is hot and may cause burns.
After emission stops, let the stroboscope sit for 30 minutes or longer.
Be sure stroboscope is cool to the touch before replacing the lamp.

- ① Remove the protection window and sheet metal by loosening the 4 screws on the window. Insert a thin screw driver into a hole of the protection window and pull out.
- ② Remove the reflector and pull out the lamp base (Glass part).



Do not pull out the lamp glass part directly.
It may break and cause injury.

- ③ Press the lamp base to the socket in the proper direction to install the new lamp.
*Do not touch to glass part of the lamp.
- ④ Put the reflector back in the center.
- ⑤ Important : In order to maintain protection against water, be sure to mount the protection window in the center.
Fix the protective window and sheet metal with the 4 screws and the sealing washers. (Tightening torque: 0.6 N·m)

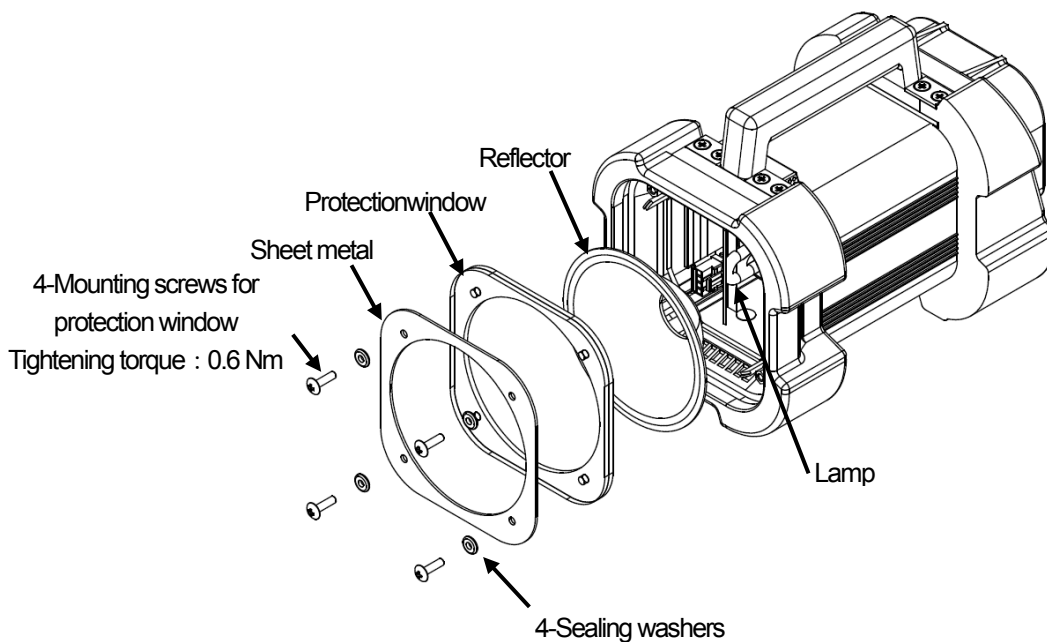

5 Specifications

5.1 Specifications list

Internal oscillation emission	Emission count	200 to 2500 fpm
	Resolution	1 fpm
	Phase change function	Available (PHA mode)
	Limit function	Available (adjustable in the function mode 3)
	Delayed emission function	Measurement range : 200 to 2500 fpm Within the range (angle) : 0 to 359°, available to set by 1° Within the range (time) : 0.0 to 299.2 ms, available to set by 0.1 ms
External synchronous emission	Input signal	H level : 5 to 24 V L level : 0 to 1 V Pulse width : 2 ms or more *Input impedance : 47 kΩ or more
	Frequency measurement range	180 to 2750 fpm
	Phase change function	Available (PHA mode)
	Division function	Available
	Resolution	1 fpm
	Delayed emission function	Measurement range : 180 to 2750 fpm Within the range (angle) : 0 to 359°, available to set by 1° Within the range (time) : 0.0 to 332.4 ms, available to set by 1 ms
Display		6-digit 7 segment red LED
Setting devices		Multi-turn encoder, tact switch
Lamp	Emission source	Xenon lamp
	input	15 W
Emission pulse width		20 μs
Emission timer		30 min (non-adjustable)
Memory function		Power OFF saving
Power supply		AC100 V (input) AC100 to 115 V 50/60 Hz
Power cable		Approx. 9 m (29.5') (with two Banana clips red/black) Red : input external pulse Black : GND
Operating temperature		0 to 40°C (32 to 104°F)
Operating humidity		35 to 85% (Non- condensing)
Protection structure		IP65 equivalent
Weight		Appox. 1.8 kg (4 lb)

Notes

* If noise causes signal integrity issues from the external input sensors, please take measures such as connecting a ferrite core to the signal line.

5.2 External dimensions

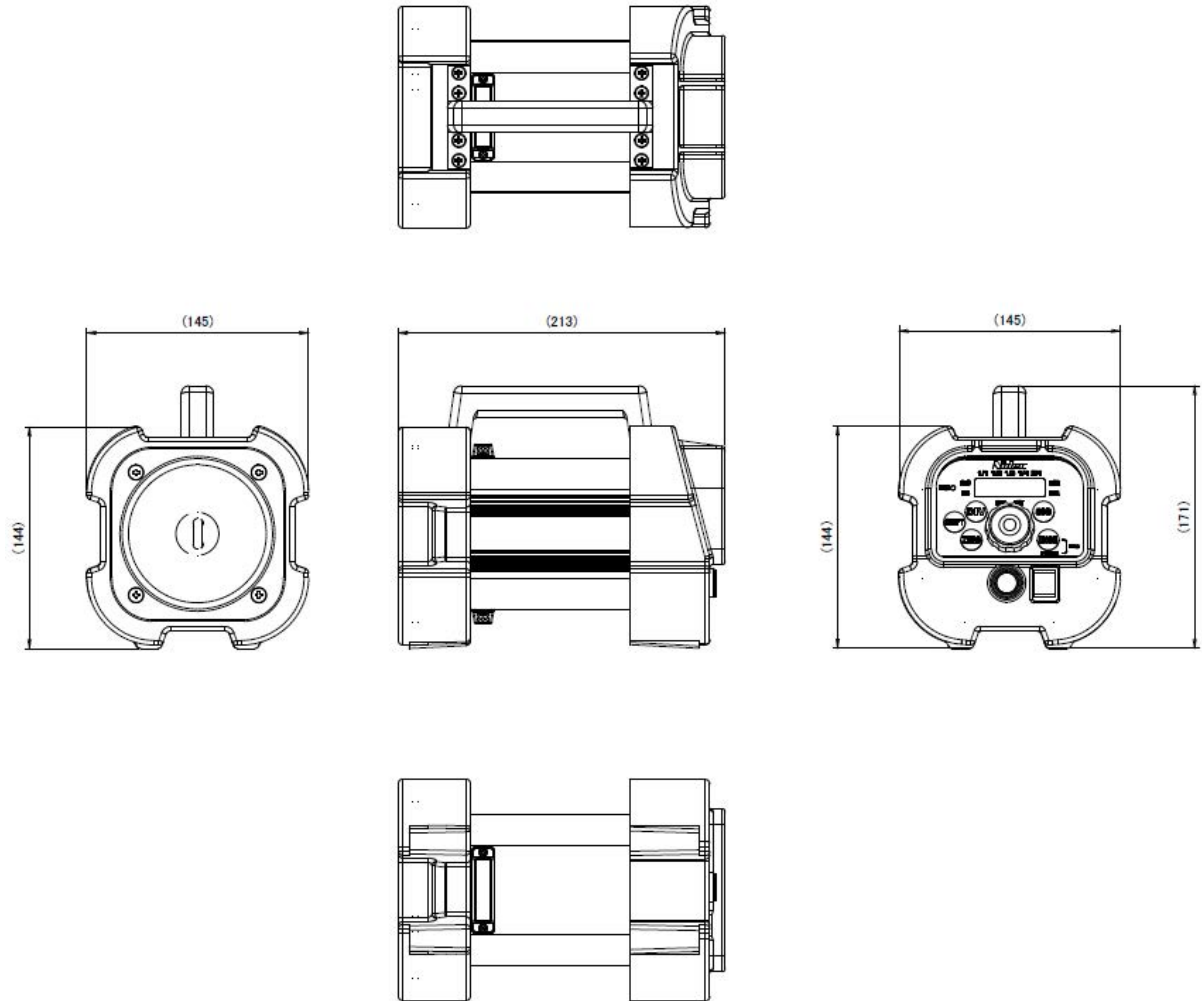

6 Troubleshooting

Troubleshooting				
Symptoms		Factors	Causes	Solution
Emission occurs inconsistently.	➔	The Xenon lamp failure.	The Xenon lamp life. Internal circuit failure.	➔ Replace the lamp, If the problem has not been solved, ask for repair.
Emission sometimes stops.	➔	The Xenon lamp failure.	The Xenon lamp life. Internal circuit failure.	➔ Replace the lamp, If the problem has not been solved, ask for repair.
Display does not change by turning the dial.	➔	Internal circuit malfunction.	Internal circuit failure.	➔ Ask for repair.
Information appears on the digital display, but no emission occurs.	➔	The Xenon lamp failure.	Internal circuit failure.	➔ Replace the lamp, If the problem has not been solved, ask for repair.
Emission occurs but does not match the display.	➔	Internal circuit malfunction.	Internal circuit failure.	➔ Ask for repair.
Nothing is indicated on the display and no emission occurs.	➔	Internal circuit malfunction.	Internal circuit failure.	➔ Ask for repair.
At measurement, the object does not stand still completely	➔	The rotation speed cannot be set accurately.	Due to resolution.	➔ It cannot be set below the second decimal place.

Q & A

Questions		Answer	Note
How long is the Xenon lamp life?	➔	About 100 million flashes.	About 100 hours by flashing 15000fpm.
Is it possible to see the object 2m away?	➔	It depends on the surrounding environment.	Please check it by using demo.
Can I shoot the video?	➔	No.	It does not have the signal for the video.
Can I take a picture?	➔	No.	It does not have the signal for pictures.
Is this washable?	➔	It is not washable.	Do not wash.
Do you have explosion-proof models?	➔	No.	Impossible at present.

NIDEC-SHIMPO AMERICA CORPORATION

175 Wall Street Glendale Heights, IL 60139 U.S.A.
Phone : +1(800)237-7079 FAX : +1(630)924-7639

NIDEC-SHIMPO CORPORATION

〒617-0833 Kyoto, Nagaokakyo, Kotari, Terada- 1
Phone : +81-75-958-3777