

R9930

REED INSTRUMENTS

Air Particle Counter



Instruction Manual

REED Instruments

1-877-849-2127 | info@reedinstruments.com | www.reedinstruments.com

Table of Contents

Introduction	4
Product Quality.....	4
Safety	4
Features	4
Included	5
Specifications.....	5-6
Instrument Description	7
Display Description	8
Software Installation.....	8
Operation Instructions.....	9-13
<i>Power ON/OFF</i>	9
<i>Taking Measurements</i>	9
<i>Capturing Images</i>	10
<i>Capturing Video</i>	10
<i>Setup Mode</i>	10-11
<i>Adjust Test Sample Time</i>	11
<i>Enable/Disable Test Start Delay</i>	11
<i>Select/Deselect Channel Display</i>	12
<i>Enable/Disable Ambient Temperature/% RH</i>	12
<i>Modify Sample Cycle</i>	12
<i>Select Sampling Mode</i>	12-13
<i>Set Time Between Test Cycles</i>	13
<i>Adjust the Alarm Limit (Level Indication)</i>	13
Media Gallery	14-15
<i>Viewing Saved Images</i>	14
<i>Viewing Saved Videos</i>	14
<i>Viewing Particle Logs</i>	15
System Settings	15-18
<i>Setting the Date & Time</i>	16
<i>Adjusting Display Font Color</i>	16

continued...

REED Instruments

1-877-849-2127 | info@reedinstruments.com | www.reedinstruments.com

<i>Setting the Language</i>	16
<i>Adjusting Display Brightness</i>	16
<i>Enable/Disable the Auto Power Off Function</i>	17
<i>Adjusting Display Timeout</i>	17
<i>Enabling/Disabling Audible Alarm</i>	17
<i>Viewing Memory Status</i>	17
<i>Restoring Default System Settings</i>	18
<i>Selecting the Temperature Unit of Measure</i>	18
<i>Updating the Firmware using the Micro SD Card</i>	18
Zeroing the Particle Count Sensor	19
Particle Count Table	19
Battery Charging	20
Battery Replacement.....	20
Micro SD Card Slot	20
Applications	21
Accessories and Replacement Parts	21
Product Care	21
Appendix A: Particle Counter Considerations	22
Product Warranty	23
Product Disposal and Recycling	23
Product Support.....	23

Introduction

Thank you for purchasing your REED R9930 Air Particle Counter. Please read the following instructions carefully before using your instrument. By following the steps outlined in this manual your meter will provide years of reliable service.

Product Quality

This product has been manufactured in an ISO9001 facility and has been calibrated during the manufacturing process to meet the stated product specifications. If a certificate of calibration is required please contact the nearest authorized REED distributor or authorized Service Center. Please note an additional fee for this service will apply.

Safety

Never attempt to repair or modify your instrument. Dismantling your product, other than for the purpose of replacing batteries, may cause damage that will not be covered under the manufacturer's warranty. Servicing should only be provided by an authorized service center.

Features

- Displays up to 6 particle sizes down to 0.3 μ m
- Ambient air temperature, humidity, dew point and wet bulb temperature measurement
- 2.8" TFT color LCD display
- Take photos and record video with built-in camera
- Selectable sampling time, count data, and programmable delay
- Export data to PC with included USB cable
- Low battery indicator and auto shut-off

Included

- AC Adapter
- USB Cable
- Zero Count Filter
- 7.4V Lithium-ion Battery
- 8GB Micro SD Memory Card and Adapter
- Protective Cap
- Factory Calibration Certificate
- Hard Carrying Case

Specifications

Particle Counter

Channels:	0.3, 0.5, 1.0, 2.5, 5.0, 10 μ m
Flow Rate:	0.1ft ³ (2.83L/min)
Counting Efficiency:	50% for particles of 0.3 μ m; 100% for particles > 0.45 μ m
Coincidence Loss:	5% at 2,000,000 particles per ft ³
Data Storage:	5000 sample records (Micro SD card)
Count Modes:	Cumulative, Differential, Concentration

Air Temperature and Relative Humidity

Air Temperature

Measuring Range:	32 to 122°F (0 to 50°C)
Accuracy:	50 to 104°F (10 to 40°C): $\pm 0.9^\circ\text{F}$ (0.5°C) 32 to 50°F (0 to 10°C): $\pm 1.8^\circ\text{F}$ (1.0°C)

Dewpoint Temperature

Measuring Range:	32 to 122°F (0 to 50°C)
Accuracy:	50 to 104°F (10 to 40°C): $\pm 0.9^\circ\text{F}$ (0.5°C) 32 to 50°F (0 to 10°C): $\pm 1.8^\circ\text{F}$ (1.0°C)

Relative Humidity

Measuring Range:	0 to 100% RH
Accuracy:	40 to 60%: $\pm 3\%$ RH

continued...

REED Instruments

1-877-849-2127 | info@reedinstruments.com | www.reedinstruments.com

General Specifications

Display:	2.8" 320 x 240 pixel TFT Color LCD
Real-Time Clock and Date Stamp:	Yes
External Memory:	Yes, expandable up to 8GB with Micro SD Card (optional)
Alarms:	Yes (audible)
Auto Shut-off:	Yes (adjustable)
Tripod Mountable:	Yes
PC Interface:	USB
Power Supply:	Universal AC Adapter/Charger; 7.4V rechargeable battery
Battery Life:	Approx. 4 hours of continuous use
Battery Charge Time:	Approx. 2 hours with AC adapter/charger
Software:	Yes (download from website)
Software OS Compatibility:	Windows 7/8/10/11
Supported Languages:	English, French, Spanish and German
Product Certifications:	CE
Operating Temperature:	32 to 122°F (0 to 50°C)
Storage Temperature:	14 to 140°F (-10 to 60°C)
Operating Humidity Range:	10 to 90% RH non-condensing
Max Operating Altitude:	6561' (2000m)
Dimensions:	9.4 x 3.0 x 2.2" (240 x 75 x 57mm)
Weight:	1.26lbs (570g)

Instrument Description

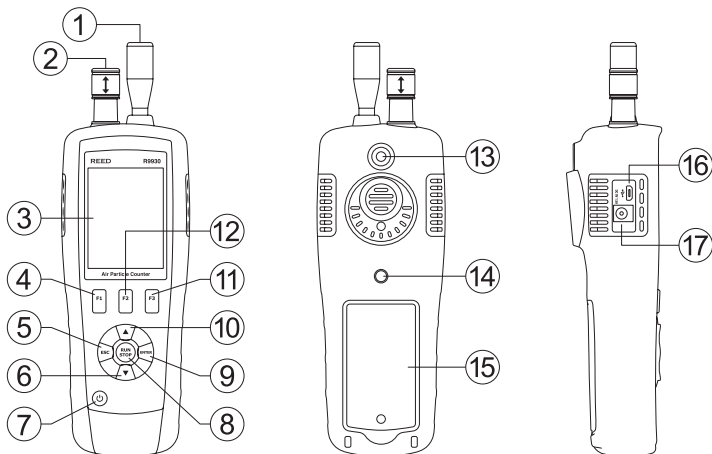

- | | |
|--------------------------------|--|
| 1. Particle Sensor | 10. UP Arrow Button |
| 2. Temperature/Humidity Sensor | 11. F3 Function Button |
| 3. Color TFT LCD Display | 12. F2 Function Button |
| 4. F1 Function Button | 13. Camera Sensor |
| 5. ESC Button | 14. Tripod Mounting Screw |
| 6. DOWN Arrow Button | 15. Battery/Micro SD Compartment
(SD card slot located under battery) |
| 7. POWER Button | 16. USB Interface |
| 8. RUN/STOP Button | 17. Power Adapter Input |
| 9. ENTER Button | |

REED Instruments

1-877-849-2127 | info@reedinstruments.com | www.reedinstruments.com

Display Description

1. Test Mode Indicator (Cumulative, Differential, Concentration)
2. Pause Indicator
3. Air Particle Size Indicators
4. Air Temperature Reading
5. Air Temperature Indicator
6. Dew Point Temperature Indicator
7. Dew Point Temperature Reading
8. Photo/Video Recording Icon
9. Media Gallery Icon
10. Setup Menu Icon
11. Wet Bulb Temperature Indicator
12. Wet Bulb Temperature Reading
13. Relative Humidity Reading
14. Relative Humidity Indicator
15. Color Coded Particle Alarm Scale
16. Battery Status Indicator
17. Time Stamp
18. Date Stamp



Software Installation

Please visit www.REEDInstruments.com/software to download the latest R9930 software. Full specifications and Operating System compatibility can be found on the product page at www.REEDInstruments.com. If you have specific questions related to your application and/or questions related to software setup and functionality please contact the nearest authorized distributor or Customer Service at info@reedinstruments.com or 1-877-849-2127.

REED Instruments

1-877-849-2127 | info@reedinstruments.com | www.reedinstruments.com

Operation Instructions

Power ON/OFF

Press and hold the POWER button to turn the meter ON or OFF.

Taking Measurements

When the meter is first powered ON, it enters the main menu screen as shown on the right.



Please ensure the particle sensor cap is removed from the meter prior to running a test. If the test is run with the cap in place it will damage the pump and other internal components. Electrical noise, sensor leakage, or other interference may cause the R9930 to show incorrect particle count data.

1. Perform a Zero calibration of the Particle count sensor. (See the *Zeroing Particle Count Sensor* section for additional details.)
2. Press the **ENTER** button to access the Particle Measurement Screen.
3. The display will show the particle count channels with readings if applicable, Air Temperature (AT), Dew Point Temperature (DP), Wet Bulb Temperature (WB), and Relative Humidity (RH).
4. Setup your testing parameters. (See the *Setup Mode* section for additional details.)
5. Open the temperature/RH sensor by sliding the protective cover downward.
6. Press the **RUN/STOP** button to start the air pump and the particle count measurement process.



Note: When the programmed sampling time has elapsed, the particle measurement cycle will end and the measurement data will automatically store. At any time, press the **RUN/STOP** button to manually end the testing session.

continued...

REED Instruments

1-877-849-2127 | info@reedinstruments.com | www.reedinstruments.com

Capturing Images

1. While in the Particle Measurement Screen, press the **F1** button to enter camera mode.
2. Press the **F1** button again to take a picture.
3. Press the **F1** button a third time to save the image or the **F3** button to delete the image.
4. Press the **ESC** button to exit camera mode and resume normal operation.

Capturing Video

1. While in the Particle Measurement Screen, press **F1** to enter camera mode.
2. Press the **F3** button to enter the video recording screen.
3. Press the **F2** button to start a recording.
4. The recording icon will flash during the duration of the recording.
5. Press the **F2** button to end a recording and the video will automatically be saved.
6. Press the **ESC** button to exit camera mode and resume normal operation.

Setup Mode

1. While in the Particle Measurement Screen, press the **F3** button to enter Setup Mode.
2. Use the UP and DOWN arrow buttons to scroll through the following list of parameters. When the desired parameter is highlighted press the **ENTER** button to modify.

Note: At any time, you can press the **ESC** button to exit Setup Mode and resume normal operation.

continued...

Parameter	Description
Sample Time	Modify test duration (3 to 60 seconds)
Start Delay	Set a delayed test start time (3 to 100 seconds)
Channel Display	Select/Deselect particle channel sizes displayed during test
Ambient Temp/% RH	Enable/Disable air temp and % RH on-screen values
Sample Cycle	Modify number of test cycles during test (1 to 100)
Sample Mode	Cumulative, differential, concentration
Interval	Set time between repeated test cycles
Level Indication	Select the Alarm Limit (level) of the corresponding particle size

Adjust Test Sample Time

Follow steps 1 through 3 once the parameter has been selected.

1. Press the **ENTER** button to activate the parameter for editing.
2. Use the UP and DOWN arrow buttons to set the desired sampling time/gas volume from 3 to 60 seconds.
3. Press the **ESC** button to save your selection and return to the setup menu.

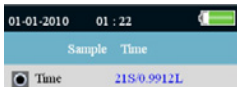

Enable/Disable Test Start Delay

Follow steps 1 through 3 once the parameter has been selected.

1. Press the **ENTER** button to activate the parameter for editing.
2. Use the UP and DOWN arrow buttons to set the test start delay time from 3 to 100 seconds.
3. Press the **ESC** button to save your selection and return to the setup menu.

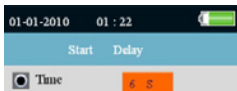

Note: The test will not start until the programmed delay time has elapsed.

continued...

REED Instruments

1-877-849-2127 | info@reedinstruments.com | www.reedinstruments.com

Select/Deselect Channel Display

Follow steps 1 through 3 once the parameter has been selected.

1. Use the UP and DOWN arrow buttons to select the desired channel.
2. Press the **ENTER** button to enable/disable the channel from appearing during a test.
3. Press the **ESC** button to save your selections and return to the setup menu.

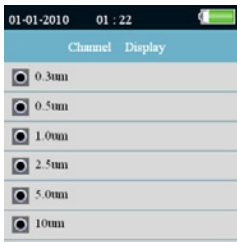

Enable/Disable Ambient Temperature/% RH

Follow steps 1 and 2 once the parameter has been selected.

1. Use the UP and DOWN arrow buttons to enable/disable the ambient temperature and relative humidity displays.
2. Press the **ESC** button to save your selection and return to the setup menu.

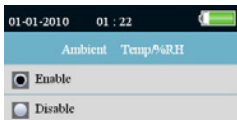

Modify Sample Cycle

Follow steps 1 through 3 once the parameter has been selected.

1. Press the **ENTER** button to activate the parameter for editing.
2. Use the UP and DOWN arrow buttons to adjust the number of cycles between 1 and 100.
3. Press the **ESC** button to save your selection and return to the setup menu.

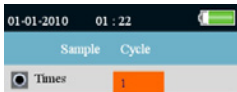

Select Sampling Mode

Cumulative Mode – Measures all particle sizes for the channels that have been selected that are greater than or equal to the particle size selected in the Sample Volume field.

Differential Mode – Measures all particles that are greater than or equal to the particle size selected in the Sample Volume field, but less than the next largest particle size.

continued...

REED Instruments

1-877-849-2127 | info@reedinstruments.com | www.reedinstruments.com

Concentration Mode – Used to take a quick sample of airborne particulates, performed especially in areas where particulate levels are unknown and may exceed the operating levels of this counter.

Follow steps 1 and 2 once the parameter has been selected.

1. Use the UP and DOWN arrow buttons to select between Cumulative, Differential and Concentration sampling mode.
2. Press the **ESC** button to save your selection and return to the setup menu.



Set Time Between Test Cycles

Please note the INTERVAL setting is only for programming the time between test cycles, not between individual measurements.

Follow steps 1 through 3 once the parameter has been selected.

1. Press the **ENTER** button to activate the parameter for editing.
2. Use the UP and DOWN arrow buttons to adjust the time between test cycles from 3 to 100 seconds.
3. Press the **ESC** button to save your selection and return to the setup menu.



Adjust the Alarm Limit (Level Indication)

When the selected particle size is exceeded, the instrument alerts the user with an audible alert.

Follow steps 1 and 2 once the parameter has been selected.

1. Use the UP and DOWN arrow buttons to select the applicable level indication.
2. Press the **ESC** button to save your selection and return to the setup menu.

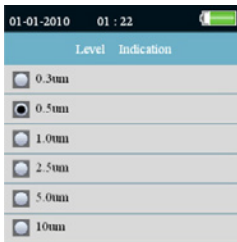

Media Gallery

The media gallery mode allows a user to view saved images, videos or particle logs.

1. While in the main menu, press the **F1** button to enter the saved media gallery. This screen can also be accessed by pressing the **F2** button while in the Particle Measurement Screen.
2. Press the UP and DOWN arrow buttons to scroll through the media gallery folders (Picture, Video or Particle Logs).
3. Once the appropriate folder has been selected follow the instructions below.

Viewing Saved Images

1. Press the **ENTER** button when "Picture" is highlighted to enter the saved pictures gallery.
2. Press the UP and DOWN arrow buttons to scroll through the picture thumbnails, if applicable.
3. Press the **ENTER** button to view the selected picture.
4. To delete a selected picture, press the **F1** button twice.
5. Press the **F3** button or **ESC** button to return to the picture gallery.
6. Press the **ESC** button again to exit the picture gallery and return to the media gallery folders.

Viewing Saved Videos

1. Press the **ENTER** button when "Video" is highlighted to enter the saved videos gallery.
2. Press the UP and DOWN arrow buttons to scroll through the picture thumbnails, if applicable.
3. Press the **ENTER** button to play the selected video.
4. To delete a selected video, press the **F1** button twice.
5. Press the **F3** button or **ESC** button to return to the video gallery.
6. Press the **ESC** button again to exit the video gallery and return to the media gallery folders.

continued...

Viewing Particle Logs

1. Press the **ENTER** button when "Particle Logs" is highlighted to enter the saved logs gallery.
2. Press the UP and DOWN arrow buttons to scroll through the log files, if applicable.
3. Press the **ENTER** button to view the selected particle log.
4. To delete a selected particle log, press the **F1** button twice.
5. Press the **F3** button or **ESC** button to return to the particle logs file list.
6. Press the **ESC** button again to exit the particle logs thumbnails and return to the media gallery folders.

System Settings

1. From the main menu, press the **F2** button to enter System Settings.
2. Press the UP and DOWN arrow buttons to scroll through the following parameters.

Items	Description
Date/Time	Set date and time
Font Color	Select the display font color
Language	Select desired menu language
Brightness	Adjust display brightness
Auto Power Off	Adjust auto power off time
Display Timeout	Adjust display auto-off time
Memory Status	Displays SD memory card status
Factory Setting	Restores factory default settings
Units (°C/°F)	Select temperature unit of measure
Firmware Update	Update firmware

3. Once the appropriate parameter has been selected follow the instructions below.

continued...

REED Instruments

1-877-849-2127 | info@reedinstruments.com | www.reedinstruments.com

Setting the Date & Time

1. While in this mode, press the **ENTER** button to toggle through the adjustable parameters.
2. When a desired parameter has been selected, press the UP and DOWN arrow buttons to adjust the value (i.e. Month/Day/Year/12 or 24 clock/Hour/Minute).
3. Press the **ENTER** button to confirm your selection and move on to the next adjustable parameter.
4. Once all parameters have been adjusted, press the **ESC** button to confirm your selection and return to the System Settings menu.

Date: 01-11-2009
Am/Pm: 06:02 Am

Adjusting Display Font Color

1. Press the **ENTER** button when "Font Color" is highlighted to enter the appropriate function.
2. Press the UP and DOWN arrow buttons to select a font color.
3. Press the **ESC** button to confirm your selection and return to the System Settings menu.

<input checked="" type="radio"/> Orange
<input type="radio"/> Green
<input type="radio"/> White
<input type="radio"/> Blue
<input type="radio"/> Gold
<input type="radio"/> Purple

Setting the Language

1. Press the **ENTER** button when "Language" is highlighted to enter the appropriate function.
2. Press the UP and DOWN arrow buttons to select a language.
3. When the desired language has been selected, press the **ESC** button to confirm your selection and return to the System Settings menu.

<input type="radio"/> 100%
<input checked="" type="radio"/> 90%
<input type="radio"/> 80%
<input type="radio"/> 70%
<input type="radio"/> 60%
<input type="radio"/> 50%
<input type="radio"/> 40%
<input type="radio"/> 30%

Adjusting Display Brightness

1. Press the **ENTER** button when "Brightness" is highlighted to enter the appropriate function.
2. Press the UP and DOWN arrow buttons to select a brightness level.
3. Press the **ESC** button to confirm your selection and return to the System Settings menu.

continued...

Enable/Disable the Auto Power Off Function

1. Press the **ENTER** button when "Auto Power Off" is highlighted to enter the appropriate function.
2. Press the UP and DOWN arrow buttons to select an auto power off time from the list or disable the feature.
3. Press the **ESC** button to confirm your selection and return to the System Settings menu.



Adjusting Display Timeout

1. Press the **ENTER** button when "Display Timeout" is highlighted to enter the appropriate function.
2. Press the UP and DOWN arrow buttons to select a display timeout time from the list or disable the feature.
3. Press the **ESC** button to confirm your selection and return to the System Settings menu.



Enabling/Disabling Audible Alarm

1. Press the **ENTER** button when "Alarm" is highlighted to enter the appropriate function.
2. Press the UP and DOWN arrow buttons to enable or disable the feature.
3. Press the **ESC** button to confirm your selection and return to the System Settings menu.



Viewing Memory Status

1. Press the **ENTER** button when "Memory Status" is highlighted to view the memory card status.
2. Press the **ESC** button to return to the System Settings menu.



continued...

Restoring Default System Settings

1. Press the **ENTER** button when "Factory Setting" is highlighted to enter the appropriate function.
2. Press the UP and DOWN arrow buttons to select Yes or No.
3. Press the **ESC** button to confirm your selection and return to the System Settings menu.

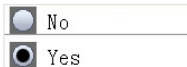

Selecting the Temperature Unit of Measure

1. Press the **ENTER** button when "Units (°C/°F)" is highlighted to enter the appropriate function.
2. Press the UP and DOWN arrow buttons to select between °C (Celsius) and °F (Fahrenheit).
3. Press the **ESC** button to confirm your selection and return to the System Settings menu.

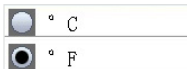

Updating the Firmware using the Micro SD Card

Make sure the Micro SD card is inserted in the meter, and that the meter is plugged into your computer via the USB cable.

1. Copy the firmware "Firmware.img" file to the SD card root directory.
2. Unplug the meter from the computer, enter System Settings and select Firmware Update.
3. Press the UP or DOWN arrow buttons to select Yes or No.
4. Press the **ENTER** button to proceed with the firmware update or press the **ESC** button to cancel.
5. Once complete, the meter will automatically restart.

Note: Make sure there is enough battery power before updating the firmware.

Zeroing the Particle Count Sensor

Particles must be purged (removed) from the sensor before and after each use in a high sample count environment.

1. Unscrew and remove the particle sensor cap.
2. Attach the Zero count filter.
3. Turn on the meter and enter Setup mode.
4. Set the Sample mode to Cumulative.
5. Set the Channel Display to ensure all channels are selected.
6. Set Sample Time to 60 seconds.
7. Set Sample Cycle to 10.
8. Press the **RUN/STOP** button to start the air pump and the zeroing process.
9. Allow the meter to run until all of the particle counts read zero. The meter may need to be run multiple times to ensure that all channels read zero.
10. Turn the meter OFF.
11. Remove the Zero count filter and re-attach the particle sensor cap.

Particle Count Table

Particle count readings are grouped by color, Green (good), Yellow (caution), and Red (hazard) and are shown for each channel.

Channel	Green	Yellow	Red
0.3µm	0 to 100,000	100,001 to 250,000	250,001 to 500,000
0.5µm	0 to 35,200	35,201 to 87,500	87,501 to 175,000
1.0µm	0 to 8320	8321 to 20,800	20,801 to 41,600
2.5µm	0 to 545	546 to 1362	1363 to 2724
5.0µm	0 to 193	194 to 483	484 to 966
10.0µm	0 to 68	69 to 170	170 to 340

Note: This table is intended for reference use only.

REED Instruments

1-877-849-2127 | info@reedinstruments.com | www.reedinstruments.com

Battery Charging

When the low battery icon appears on the LCD display, the battery must be recharged. Connect the power adapter to the input jack located on the meter's left side compartment and then connect the other end of the cable to a receptacle. Please note the meter will not charge via USB.

Battery Replacement

1. Remove the Phillips head screw on the back of the meter.
2. Remove the battery cover.
3. Replace the 7.4V Lithium-ion polymer rechargeable battery.
4. Secure the battery cover back with the Phillips head screw.

Micro SD Card Slot

The Micro SD card slot is located inside the battery compartment underneath the battery. The meter accepts Micro SD cards up to 8GB.

1. Make sure the meter is off and remove the AC adapter cable if connected.
2. Open the battery compartment and remove the battery.
3. Open the metal holder by sliding the holder upwards.
4. Insert a Micro SD card (up to 8GB max.) in the card slot underneath the battery by lifting up on the metal card holder and placing the Micro SD card in the connector by facing the pins towards the top of the meter. Close the metal holder and lock it into place by sliding the holder downwards.
5. Insert the battery back into place and secure the cover before powering on the meter.

Applications

- Data centers
- IAQ testing
- Particle counting
- Cleanrooms
- Operating rooms
- Pharmaceuticals

Accessories and Replacement Parts

- **R9930-ADP** Power Supply, 110V
- **R9930-7.4V** Replacement Battery
- **CA-05A** Soft Carrying Case
- **R8890** Large Hard Carrying Case
- **R1500** Tripod

Don't see your part listed here? For a complete list of all accessories and replacement parts visit your product page on www.REEDinstruments.com.

Product Care

To keep your instrument in good working order we recommend the following:

- Store your product in a clean, dry place.
- Change the battery as needed.
- If your instrument isn't being used for a period of one month or longer please remove the battery.
- Clean your product and accessories with biodegradable cleaner. Do not spray the cleaner directly on the instrument. Use on external parts only.

Appendix A: Particle Counter Considerations

Particle pollution is a mixture of various components including smoke, dust, chemicals, mold, and gases. Particle concentrations can affect our health and comfort levels. Evaluating the quality of the air by determining the concentration and size of these particles can help to determine if a problem exists. Locating the source of these various particles can help to determine effective methods of reducing these and improving the Indoor Air Quality (IAQ).

One way to determine the source of air particulates in a room is to test the air outside of the room under investigation. Determine the concentration and size of particulates at the air intake to that room. Purge or Zero the particle counter and then measure the concentration and size of particles in multiple areas of the room to be tested, to determine the effectiveness of the incoming air filtration. The air temperature, relative humidity, and CO₂ levels are also an important consideration for IAQ as high humidity and lower temperatures can bring about mold creation.

If a room is classified as an ISO clean room or clean zone, the counts of particle sizes for that class cannot be exceeded when tested. Refer to the ISO Clean Room Class chart (ISO 14644-1:1999) for values.

The R9930 is equipped with a still/video camera to directly see the areas under test. Data, images, and video can be stored on up to an 8GB Micro SD card (not included) or in the meter's internal 74MB memory.

The life of the meter can be maximized by testing only when necessary and securely storing the instrument when it is not in use. Continuous use is not recommended and can shorten the life of the instrument especially in dusty environments. Setting up a common sense maintenance schedule and testing to the schedule will go a long way in lengthening the life of the instrument sensor.

Product Warranty

REED Instruments guarantees this instrument to be free of defects in material or workmanship for a period of one (1) year from date of shipment. During the warranty period, REED Instruments will repair or replace, at no charge, products or parts of a product that proves to be defective because of improper material or workmanship, under normal use and maintenance. REED Instruments total liability is limited to repair or replacement of the product. REED Instruments shall not be liable for damages to goods, property, or persons due to improper use or through attempts to utilize the instrument under conditions which exceed the designed capabilities. In order to begin the warranty service process, please contact us by phone at 1-877-849-2127 or by email at info@reedinstruments.com to discuss the claim and determine the appropriate steps to process the warranty.

Product Disposal and Recycling



Please follow local laws and regulations when disposing or recycling your instrument. Your product contains electronic components and must be disposed of separately from standard waste products.

Product Support

If you have any questions on your product, please contact your authorized REED distributor or REED Instruments Customer Service by phone at 1-877-849-2127 or by email at info@reedinstruments.com.

Please visit www.REEDInstruments.com for the most up-to-date manuals, datasheets, product guides and software.

*Product specifications subject to change without notice.
All rights reserved. Any unauthorized copying or reproduction of this manual is strictly prohibited without prior written permission from REED Instruments.*

REED Instruments

1-877-849-2127 | info@reedinstruments.com | www.reedinstruments.com

REED INSTRUMENTS

TEST & MEASURE WITH CONFIDENCE



Access our
Product Catalog

Over 200 portable test and
measurement instruments



REED Instruments

1-877-849-2127 | info@reedinstruments.com | www.reedinstruments.com