

R9920

REED INSTRUMENTS

Indoor Air Quality Meter Instruction Manual



REED Instruments

1-877-849-2127 | info@reedinstruments.com | www.reedinstruments.com

Table of Contents

Introduction	3
Product Quality	3
Safety	3
Features	3-4
Included	4
Specifications	4-5
Instrument Description	6
Display Description	6
Operating Instructions	7-15
<i>Setting up the R9920</i>	7
<i>Power ON/OFF</i>	7
<i>Main Operating Modes (Live and Data logging)</i>	7-8
<i>Live Mode</i>	7
<i>Data Logging Mode</i>	7
<i>Screen Saver Mode</i>	8
<i>Setup Mode</i>	8
<i>General Setup</i>	9
<i>Recording Setup</i>	9-10
<i>View Alarms</i>	11
<i>History</i>	11-12
<i>Display</i>	13
<i>Date & Time</i>	14
<i>Info</i>	15
Capturing a Screenshot	15
Data Upload	15
Charging the Battery	16
Applications	16
Product Care	16
Product Warranty	17
Product Disposal and Recycling	17
Product Support	17

Introduction

Thank you for purchasing your REED R9920 Indoor Air Quality Meter. Please read the following instructions carefully before using your instrument. By following the steps outlined in this manual your meter will provide years of reliable service.

Product Quality

This product has been manufactured in an ISO9001 facility and has been calibrated during the manufacturing process to meet stated product specifications. If a certificate of calibration is required please contact the nearest authorized REED distributor or authorized Service Center. Please note an additional fee for this service will apply.

Safety

- Never attempt to repair or modify your instrument. Dismantling your product may cause damage that will not be covered under the manufacturer's warranty. Servicing should only be provided by an authorized service center.
- Avoid condensation on CO₂ sensor.
- Do not hold the meter in close proximity to your mouth as exhalation affects CO₂ levels.
- Do not drop, subject to shock or use excessive force as it may result in damage to the meter.
- Do not use the meter in extreme conditions or near a heat source for any extended period of time to avoid damage.

Features

- Simultaneously monitors carbon dioxide (CO₂), temperature and relative humidity
- Low-drift NDIR CO₂ sensor for stable and accurate readings
- User selectable unit of measure (°C or °F)
- 7" (178 mm) high-resolution color TFT LCD (1024 x 600 pixels)
- User adjustable high and low alarms

continued...

REED Instruments

1-877-849-2127 | info@reedinstruments.com | www.reedinstruments.com

- Max/Min Display
- Internal 16 GB memory stores data points in CSV format
- User selectable sampling rate from 1 sec to 24 hrs
- Internal time and date stamp
- Rechargeable li-ion battery
- Built-in desk stand and wall mounting bracket
- Low battery indicator

Included

- Indoor Air Quality Meter, Desktop/Wall Mount
- USB Cable
- Power Adapter
- Wall Mounting Bracket

Specifications

Temperature

Measuring Range:	32 to 122°F (0 to 50°C)
Accuracy:	±1.8°F (1°C)
Resolution:	0.1°F/°C

Humidity

Measuring Range:	0 to 100% RH
Accuracy:	±3.5% (20-80% RH) ±5% (<20% & >80% RH)
Resolution:	0.1% RH

CO₂ (Carbon Dioxide)

Sensor Type:	Nondispersive Infrared (NDIR)
Measuring Range:	0 to 9999ppm
Accuracy:	±5% rdg +75ppm
Resolution:	1ppm
Response Time:	<2 seconds

continued...

REED Instruments

1-877-849-2127 | info@reedinstruments.com | www.reedinstruments.com

General Specifications

Display:	7" High-resolution color TFT
Display Resolution:	1024 x 600 pixels
Adjustable Brightness:	Yes
Min:	Yes
Max:	Yes
Datalogging Capabilities:	Yes
Real-Time Clock and Date Stamp:	Yes
Selectable Sampling Rate:	Yes (between 1second and 24 hours)
Internal Memory:	Yes (16 GB)
Alarms:	Yes (Low and High)
Kick Stand:	Yes
Wall Mountable:	Yes (bracket included)
Low Battery Indicator:	Yes
Power Supply:	3000mAh rechargeable Li-ion battery/ Power Adapter
Battery Life:	~2 hours
Charge Time:	~9 hours
PC Connectivity:	USB Cable (Type-C)
USB Cable Length:	10' (3m)
Product Certifications:	CE
Operating Temperature:	14 to 104°F (10 to 40°C)
Storage Temperature:	14 to 104°F (10 to 40°C)
Operating Humidity Range:	0 to 100%
Maximum Operating Altitude:	6561' (2000m)
Dimensions:	7.8 x 4.6 x 1" (198 x 118 x 25.7mm)
Weight:	12.9oz (365g)

Instrument Description

1. LCD Display
2. Power Button
3. CO₂ Sensor
4. USB Terminal
5. Temperature/
Humidity Probe
6. Kickstand

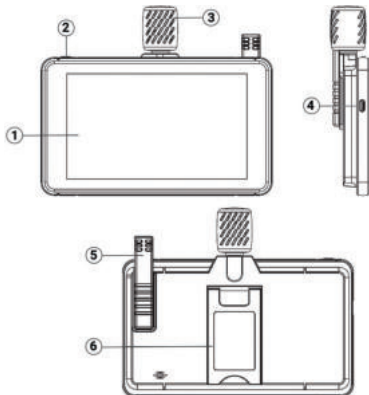

Display Description

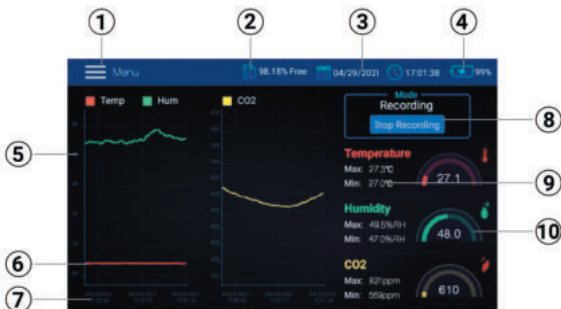

1. Menu Function
2. Memory Status Indicator
3. Date and Time Stamp
4. Battery Status Indicator
5. Numerical Scale
6. Graphical Scale
7. Time and Date Scales
8. Recording Button
9. Maximum/Minimum Measurement Values
10. Real-Time Measurement Values

REED Instruments

1-877-849-2127 | info@reedinstruments.com | www.reedinstruments.com

Operating Instructions

Setting up the R9920

While the meter is off, slide the temperature and humidity sensor directly onto the cradle jack.

Note: The R9920 can be mounted on a wall using the supplied wall mount bracket and screws. Mount the bracket on the wall first and then snap the meter onto the bracket. The wall mount bracket has a swivel arm for convenient angling. Make sure to mount the bracket with the hinge to the right in order for the display to be upright.

Power ON/OFF

To turn the meter ON, press and hold the POWER button for approx. 3 seconds. To turn the meter OFF, press and hold the POWER button for approx. 2 seconds and tap on power **OFF** when it appears on the LCD display.

Main Operating Modes (Live and Data Logging)

Live Mode

In Live mode (default setting), the R9920 displays air temperature, relative humidity, and CO₂ graphically and digitally on the main interface screen while also displaying the Min-Max values for each digitally.

Data Logging Mode

While in Data Logging mode, the R9920 displays air temperature, relative humidity, and CO₂ same way that it does in Live mode while logging measurement data to internal files at a programmable sampling rate. You can open and view these internal files right on the meter screen or transfer them as CSV formatted files directly to a PC. (See Data Upload and Setup Mode sections of the manual for additional details.)

Note: To obtain stable and accurate measurements, it is always recommended to allow the meter to get acclimated to its environment. (Approx. 3-5 minutes)

continued...

REED Instruments

1-877-849-2127 | info@reedinstruments.com | www.reedinstruments.com

Screen Saver Mode

When the R9920 is idle for 60 seconds, the screen saver activates as shown below. Simply tap on the screen to return to the main interface screen.



Setup Mode

1. Tap the **MENU** button on the Main Interface Screen to enter Setup Mode.
2. Tap the screen to select between the following parameters:

General Setup	Set the alarm values and temperature unit of measure
Recording Setup	Set the data logging sampling rate
View Alarms	View historical alarms
History	View historical data files
Display	Adjust the display settings
Date & Time	Set the time and date
Info	View meter information and upgrade firmware

3. Once the appropriate parameter has been selected, follow the instructions below.

continued...

REED Instruments

1-877-849-2127 | info@reedinstruments.com | www.reedinstruments.com

General Setup

1. Set the required Temperature unit of measure by tapping on the circle next to °F or °C.
2. Set the Alarm ON or OFF by tapping on the toggle switch.
3. To set the HIGH and LOW Alarm thresholds for temperature, humidity and CO₂, open the numerical keypad by tapping the small arrow to the right of each alarm programming field. (Alarm must be enabled)
4. Tap **SAVE** to confirm your settings or tap on the **X** to cancel and resume normal operation.



Note: At any time, you can tap on the **X** to exit the Setup mode and resume normal operation.

Recording Setup

The sampling rate can be set from "1" second to 23 hours, 59 minutes and 59 seconds.

1. To set the sampling rate, open the interactive numerical keypad by tapping the required hours, minutes, and seconds sampling rate fields.
2. To enable or disable a scheduled recording tap on the toggle switch.
3. To set a recording start time, open the interactive calendar by tapping the small arrow to the right of the programming field. (Scheduled recording must be enabled)

Note: The default start time is the current system date and time.

continued...

REED Instruments

1-877-849-2127 | info@reedinstruments.com | www.reedinstruments.com

- To select the maximum number of data points, open the interactive options box by clicking the small arrow to the right of the programming field.
- Select between 500, 1k, 5k, 10k, 20k or MAX.

Note: If MAX is selected, the meter will create multiple 20,000 data point files and recording will continue until you manually stop the recording (by tapping STOP RECORDING on the Main Interface Screen) or until it reaches full internal memory (16GB).

- Tap **SAVE** to confirm your settings or tap on the **X** to cancel and resume normal operation.

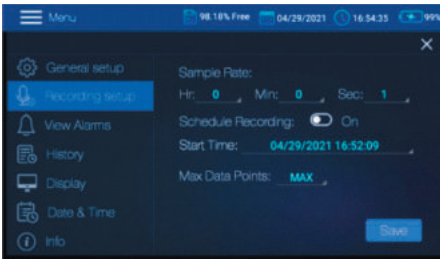

Note: At any time, you can tap on the **X** to exit the Setup mode and resume normal operation.

continued...

REED Instruments

1-877-849-2127 | info@reedinstruments.com | www.reedinstruments.com

View Alarms

1. Swipe up or down to scroll through the history of Alarm events (if any).
2. To sort the Alarm events by date, open the interactive calendar by tapping the programming fields next to "Sort by date".
3. To sort the Alarm events by high/low measurement values, open an interactive keypad by tapping on the programming fields next to "Sort by value" for temperature, humidity and CO₂.



Note: At any time, you can tap on the **X** to exit the Setup mode and resume normal operation.

continued...

REED Instruments

1-877-849-2127 | info@reedinstruments.com | www.reedinstruments.com

History

1. Scroll up or down to scroll through the list of historical data files.
2. Select a data file by first tapping it (to highlight it) and then tap **OPEN** or **CANCEL**.
3. To delete a file, tap the check box located on the right end of the specific data file, and then tap **DELETE**.
4. To delete all files, tap the check box located next to "All", and then tap **DELETE**.

Note: At any time, you can tap on the **X** to exit the Setup mode and resume normal operation.

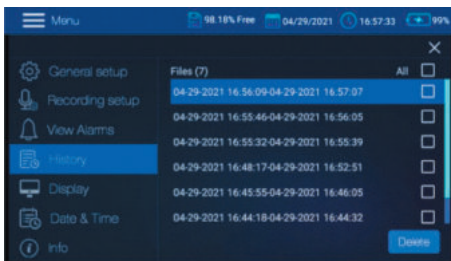
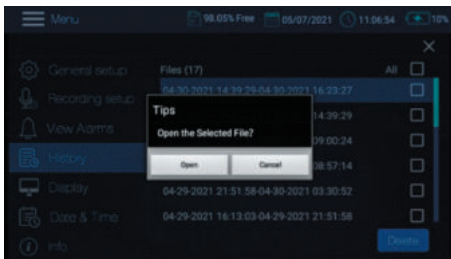

continued...

REED Instruments

1-877-849-2127 | info@reedinstruments.com | www.reedinstruments.com

Display

1. To adjust the brightness of the display, drag the Brightness slider to the right or left.

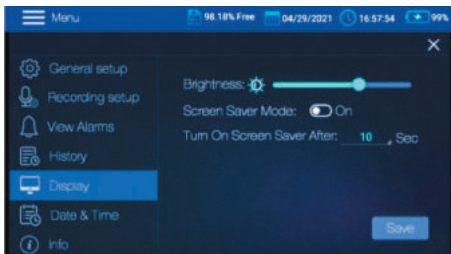

2. Set the screen saver mode ON or OFF by tapping on the toggle switch.
3. To enter the screen saver timeout time, open the interactive time options box by tapping the small arrow to the right of the programming field.
4. Select between 10, 20, 30 or 60 seconds.
5. Tap **SAVE** to confirm your settings or tap on the **X** to cancel and resume normal operation.
6. When active, the screen-saver mode appears as shown below, providing real-time relative humidity, air temperature, and CO₂ levels.



Note: At any time, you can tap on the **X** to exit the Setup mode and resume normal operation.

continued...

REED Instruments

1-877-849-2127 | info@reedinstruments.com | www.reedinstruments.com

Date & Time

1. To set the Date and Time, open the interactive calendar by tapping the small arrow to the right of the programming field.
2. Scroll up or down to set the applicable Year, Month, Day, Hour, Minute and AM or PM (12 hour format must be enabled).
3. Tap **OK** to confirm your selections or tap on **CANCEL**.

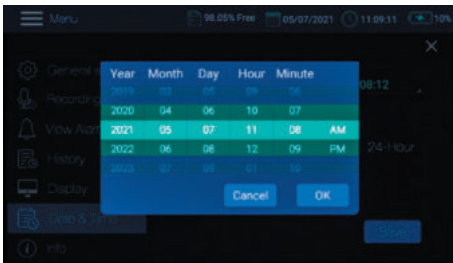

4. To set the Date format, open the interactive options box by tapping the small arrow to the right of the programming field.
5. Select between DD/MM/YYYY or YYYY/MM/DD.
6. Set the required time format by tapping on the circle next to "12-Hour" or "24-Hour" format.

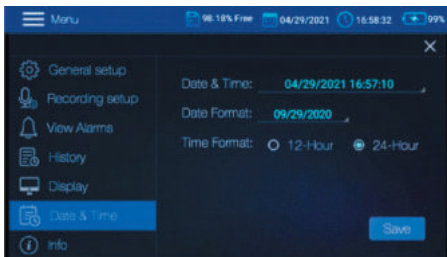

Note: At any time, you can tap on the **X** to exit the Setup mode and resume normal operation.

continued...

REED Instruments

1-877-849-2127 | info@reedinstruments.com | www.reedinstruments.com

Info

Provides information on the model number, current firmware version, manufacturer name and allows you to update the firmware version (if required).

Note: At any time, you can tap on the **X** to exit the Setup mode and resume normal operation.

Capturing a Screenshot

The R9920 allows you to take a screenshot of the current display by swiping downward on the entire screen with three (3) fingers. All screenshots are stored in the Pictures folder located in the R9920 internal storage directory for easy access.

Data Upload

Connect the R9920 via the included cable to a USB port on your PC, to download the recorded data files. The R9920 saves recorded data to a CSV (Excel) in the RH-T Data folder. Once connected, the PC will recognize the R9920 as a USB storage device. View the R9920 internal memory as you would any external storage device.

#	A	B	C	D	E	F	G
1	NO.	Temp(Fahr	CO2	Dew point	Time		
2	1	71.2	6000	57.7	01/01/2015	06:41:30	
3	2	71.2	6000	57.7	01/01/2015	06:41:31	
4	3	71.2	5890	57	01/01/2015	06:41:32	
5	4	71.2	5800	56.8	01/01/2015	06:41:33	
6	5	71.2	5700	57.4	01/01/2015	06:41:34	
7	6	71.2	5700	58.6	01/01/2015	06:41:35	
8	7	71.2	5690	57.9	01/01/2015	06:41:36	
9	8	71.2	5680	57.9	01/01/2015	06:41:37	
10	9	71.2	5670	57.7	01/01/2015	06:41:38	
11	10	71.2	5660	57.2	01/01/2015	06:41:39	
12	11	71.2	5500	56.5	01/01/2015	06:41:40	
13	12	71.2	Kann	55.9	01/01/2015	06:41:41	

Charging the Battery

Connect the R9920 via the included cable to a USB port on your PC or into a wall outlet using the included USB Power Adapter to charge the Li-ion battery.

Note: Charge the meter until the battery indicator appears full and remove the charging cable when done.

Applications

Environmental Monitoring in:

- Schools
- Office buildings
- Greenhouses
- Factories
- Hotels
- Hospitals
- Laboratories
- Areas or manufacturing processes where high levels of carbon dioxide must be measured

Product Care

To keep your instrument in good working order we recommend the following:

- Store your product in a clean, dry place.
- Charge the battery as needed.
- Clean your product and accessories with biodegradable cleaner. Do not spray the cleaner directly on the instrument. Use on external parts only.

Product Warranty

REED Instruments guarantees this instrument to be free of defects in material or workmanship for a period of one (1) year from date of shipment. During the warranty period, REED Instruments will repair or replace, at no charge, products or parts of a product that proves to be defective because of improper material or workmanship, under normal use and maintenance. REED Instruments total liability is limited to repair or replacement of the product. REED Instruments shall not be liable for damages to goods, property, or persons due to improper use or through attempts to utilize the instrument under conditions which exceed the designed capabilities. In order to begin the warranty service process, please contact us by phone at 1-877-849-2127 or by email at info@reedinstruments.com to discuss the claim and determine the appropriate steps to process the warranty.

Product Disposal and Recycling



Please follow local laws and regulations when disposing or recycling your instrument. Your product contains electronic components and must be disposed of separately from standard waste products.

Product Support

If you have any questions on your product, please contact your authorized REED distributor or REED Instruments Customer Service by phone at 1-877-849-2127 or by email at info@reedinstruments.com.

Please visit www.REEDInstruments.com for the most up-to-date manuals, datasheets, product guides and software.

*Product specifications subject to change without notice.
All rights reserved. Any unauthorized copying or reproduction of this manual is strictly prohibited without prior written permission from REED Instruments.*

REED Instruments

1-877-849-2127 | info@reedinstruments.com | www.reedinstruments.com

REED

INSTRUMENTS

TEST & MEASURE WITH CONFIDENCE



CHECK OUT OUR LATEST PRODUCTS!

REED Instruments

1-877-849-2127 | info@reedinstruments.com | www.reedinstruments.com