

R5055

# REED INSTRUMENTS

## 1000A True RMS Digital Clamp Meter



## Instruction Manual



**REED Instruments**

1-877-849-2127 | [info@reedinstruments.com](mailto:info@reedinstruments.com) | [www.reedinstruments.com](http://www.reedinstruments.com)

# Table of Contents

Introduction .....	3
Product Quality.....	4
Safety .....	4
Electrical Symbols.....	5
Features.....	6
Included.....	6
Specifications.....	7-9
Instrument Description .....	10
Display Description .....	11
Operating Instructions.....	12-19
<i>AC/DC Current Measurements.....</i>	<i>12</i>
<i>Current Frequency Measurement.....</i>	<i>12</i>
<i>Inrush Current Measurement.....</i>	<i>12-13</i>
<i>AC/DC Voltage Measurements.....</i>	<i>13</i>
<i>Voltage Frequency Measurement.....</i>	<i>13</i>
<i>Low Pass Filter (LPF) ACV Measurement.....</i>	<i>14</i>
<i>Low Impedance (LoZ) ACV Measurement.....</i>	<i>14</i>
<i>LoZ ACV Frequency Measurement .....</i>	<i>14</i>
<i>Resistance Measurement .....</i>	<i>15</i>
<i>Continuity Measurement .....</i>	<i>15</i>
<i>Diode Test.....</i>	<i>15-16</i>
<i>Capacitance Measurement.....</i>	<i>16</i>
<i>Frequency/Duty Ratio Measurement.....</i>	<i>16</i>

*continued...*

**REED Instruments**

1-877-849-2127 | [info@reedinstruments.com](mailto:info@reedinstruments.com) | [www.reedinstruments.com](http://www.reedinstruments.com)

<i>Contact Temperature Measurement</i> .....	17
<i>Non-Contact Voltage (NCV) Detection</i> .....	17
<i>Auto and Manual Range</i> .....	18
<i>Relative Mode</i> .....	18
<i>Auto Power Off</i> .....	18
<i>MAX/MIN Measurement</i> .....	19
<i>Data Hold</i> .....	19
<i>Backlight</i> .....	19
Battery Replacement.....	19
Applications.....	19
Accessories and Replacement Parts .....	20
Appendix A.....	20-22
<i>AC Current Measurement with Flexible Probe</i> .....	20-21
<i>AC Current Frequency Measurement with Flexible Probe</i> .....	21
<i>Inrush AC Current Measurement</i> .....	22
Product Care .....	23
Product Warranty .....	23
Product Disposal and Recycling .....	23
Product Support.....	24

## Introduction

Thank you for purchasing your REED R5055 1000A True RMS Digital Clamp Meter. Please read the following instructions carefully before using your instrument. By following the steps outlined in this manual your meter will provide years of reliable service.













## Product Quality

This product has been manufactured in an ISO9001 facility and has been calibrated during the manufacturing process to meet stated product specifications. If a certificate of calibration is required please contact the nearest authorized REED distributor or authorized Service Center. Please note an additional fee for this service will apply.

## Safety

- Read and understand this user manual before operating the meter.
- Never attempt to repair or modify your instrument. Dismantling your product, other than for the purpose of replacing batteries, may cause damage that will not be covered under the manufacturer's warranty. Servicing should only be provided by an authorized service center.
- Do not exceed the maximum allowable input range of any function.
- Do not apply voltage to the meter when resistance function is selected.
- Set the rotary function switch to **OFF** when the meter is not in use.
- Set the rotary function switch to the appropriate position before measuring.
- When measuring volts do not switch to current/resistance modes.
- After taking a measurement or when switching between functions always disconnect the test leads from the circuit under test.
- Do not exceed the maximum stated input limits.
- Improper use of this meter can cause damage, shock, injury or death.
- Always remove the test leads before replacing the battery.
- Inspect the condition of the test leads and the meter itself for any damage before operating.
- Remove the battery if the meter will be stored for an extended period of time.
- Always discharge capacitors and remove power from the device under test before performing diode, resistance, or continuity tests.

# Electrical Symbols

Symbol	Description
	Equipment protected throughout by double insulation or reinforced insulation
	Earth (ground)
	Warning or Caution
	Alternating current
	Direct current
	Continuity buzzer
	Diode
	Capacitance
	Alternating current or direct current
	Caution, possibility of electric shock
	Application around and removal from uninsulated hazardous live conductors is permitted
	Complies with European Union Standards
	Conforms to UL STD 61010-1, 61010-2-032, 61010-2-033, Certified to CSA STD C22.2 No. 61010-1, 61010-2-032, 61010-2-033
CAT III	It is applicable to testing and measuring circuits connected to the distribution part of the building's low-voltage mains installation
CAT IV	It is applicable to testing and measuring circuits connected at the source of the building's low-voltage mains installation

## Features

- Measures AC/DC current/voltage, resistance, capacitance, frequency, duty cycle, and contact temperature
- 6,000-count backlit LCD display and analog bargraph
- Flexible current probe can expand AC current measurements up to 3000A (with R5065, sold separately)
- Ergonomic design fits in your hand and can be used while wearing protective gloves
- Built-in LED flashlight
- Low battery and over range indicators
- Built-in non-contact voltage detector with LED indicator
- True RMS voltage and current for accurate measurements
- Low Pass Filter(LPF) and Low Impedance (LoZ) modes
- Min/Max, display hold and relative mode
- Diode test and continuity check functions
- Durable double molded plastic housing
- Cat. III 1000V, Cat. IV 600V safety rating

## Included

- Type K Thermocouple
- Test Leads
- Batteries
- Carrying Case

# Specifications

## AC/DC Current

Range:	60, 600, 1000A
Accuracy:	AC/DC: $\pm(2\% \text{ rdg. } +5 \text{ dgt.})$
Resolution:	0.01, 0.1, 1A

## AC/DC Voltage

Range:	AC: 6, 60, 600, 1000V DC: 600mV, 6, 60, 600, 1000V
Accuracy:	AC: $\pm(1.0\% \text{ rdg. } +8 \text{ dgt.})$ DC: $\pm(0.5\% \text{ rdg. } +5 \text{ dgt.})$
Resolution:	0.1mV, 0.001V, 0.01V, 0.1V, 1V

## Resistance

Range:	600 $\Omega$ , 6, 60, 600k $\Omega$ , 6, 60M $\Omega$
Accuracy:	$\pm(1\% \text{ rdg. } +2 \text{ dgt.})$ 0.1 $\Omega$ , 0.001k $\Omega$ , 0.01k $\Omega$ , 0.1k $\Omega$ , 0.001M $\Omega$ , 0.01M $\Omega$

## Capacitance

Range:	60, 600.0nF, 6, 60, 600uF, 6, 60mF
Accuracy:	$\pm(4.0\% \text{ rdg. } +5 \text{ dgt.})$
Resolution:	0.01nF, 0.1nF, 0.001 $\mu$ F, 0.01 $\mu$ F, 0.1 $\mu$ F, 0.001mF, 0.01mF

## Frequency

Range:	10Hz, 1MHz
Accuracy:	$\pm(0.1\% \text{ rdg. } +3 \text{ dgt.})$
Resolution:	0.01Hz, 1kHz

## Low Pass Filter (LPF)

### AC Voltage

Range:	600, 1000V
Accuracy:	$\pm(2\% \text{ rdg. } +5 \text{ dgt.})$
Resolution:	0.1, 1V

*continued...*

**REED Instruments**

1-877-849-2127 | [info@reedinstruments.com](mailto:info@reedinstruments.com) | [www.reedinstruments.com](http://www.reedinstruments.com)

## Low Impedance (LoZ)

### AC Voltage

Range:	600, 1000V
Accuracy:	±(2% rdg. +5 dgt.)
Resolution:	0.1, 1V

### Temperature

Range:	-40 to 1832°F (-40 to 1000°C)
Accuracy:	±(1.0% rdg. + 4°F) ±(1.0% rdg. + 2°C)
Resolution:	1°F, 1°C

## General Specifications

Range Selection:	Autoranging/Manual
Low Impedance (LoZ):	Yes
Low Pass Filter (LPF):	Yes
True RMS:	Yes
Display:	6,000 count LCD display
Display Hold:	Yes
Max/Min:	Yes
Peak Hold:	N/A
Zero Push Button Adjustment:	Yes
Relative Mode:	Yes
Diode Test:	Yes
Backlit Display:	Yes
Analog Bargraph:	Yes (31-segment)
Continuity Check:	Audible signal if resistance $\leq 30\Omega$
Duty Cycle:	Yes
Non-Contact Voltage Detector:	Yes
Built-In Flashlight:	Yes
Kick Stand:	N/A

*continued...*

**REED Instruments**

1-877-849-2127 | [info@reedinstruments.com](mailto:info@reedinstruments.com) | [www.reedinstruments.com](http://www.reedinstruments.com)



Autoshut Off:	Yes (after 15 mins)
Flexible Current Probe (optional):	Yes (R5065, Extends to 3000A)
Power Supply:	3 x AAA batteries
Low Battery Indicator:	Yes
Jaw Opening:	1.7" (42mm), up to 1500 MCM
Overvoltage Category:	CAT. III 1000V, CAT. IV 600V
Product Certifications:	CE, ETL
Operating Temperature:	32 to 122°F (0 to 50°C)
Storage Temperature:	14 to 140°F (-10 to 60°C)
Dimensions:	10.7x 3.2 x 1.7" (272 x 81 x 43.5mm)
Weight:	15.8oz (447g)

# Instrument Description

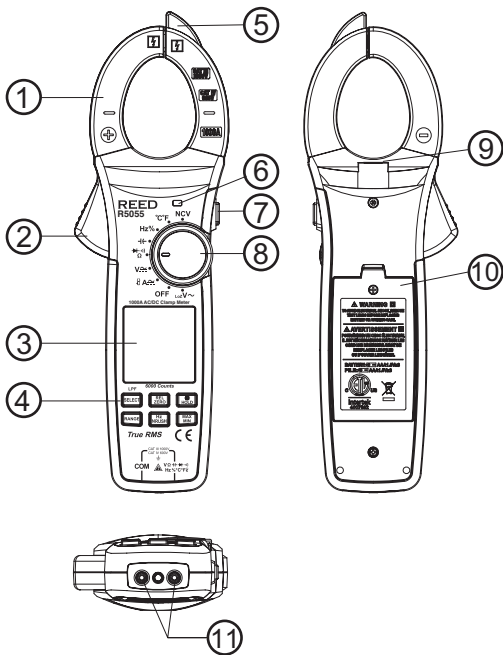

- |   |                           |
|---|---------------------------|
| 1. Current Clamp                          | 7. Flashlight Button      |
| 2. Clamp Trigger                          | 8. Rotary Function Switch |
| 3. LCD Display                            | 9. Flashlight LED Light   |
| 4. Function Buttons                       | 10. Battery Cover         |
| 5. Non-Contact Voltage Sensor             | 11. Input Jacks           |
| 6. Non-Contact AC Voltage Indicator Light |                           |

**REED Instruments**

1-877-849-2127 | [info@reedinstruments.com](mailto:info@reedinstruments.com) | [www.reedinstruments.com](http://www.reedinstruments.com)

# Display Description

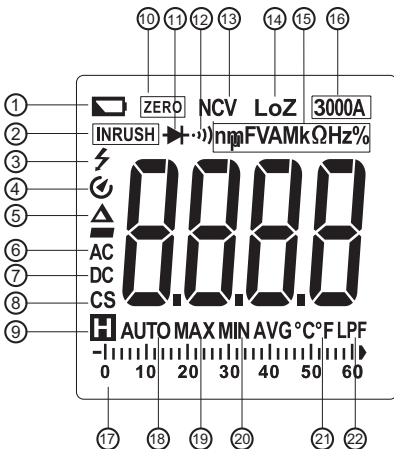

1. Low Battery Indicator
2. Inrush Current Measurement Indicator
3. High Voltage Indicator
4. Auto Power Off Indicator
5. Relative Mode Indicator
6. AC Signal Indicator
7. DC Signal Indicator
8. Flexible Current Probe Indicator (R5065 required)
9. Data Hold Indicator
10. Zero Mode Indicator
11. Diode Test Mode Indicator
12. Audible Continuity Indicator
13. Non-Contact Voltage Indicator
14. Low Impedance Measurement Indicator
15. Units of Measurement
16. Flexible Current Probe Range Indicator (R5065 required)
17. Analog Bar
18. Auto Range Mode Indicator
19. Max Measurement Indicator
20. Min Measurement Indicator
21. Temperature Measurement Indicator
22. Low Pass Filter Measurement Indicator

# Operating Instructions

## AC/DC Current Measurements

1. Set the rotary function switch to the **A** position and select either AC or DC by pressing the **SELECT** button.

Prior to taking DC current measurements wait for the display to stabilize. When stable, push the Zero button to ensure accurate readings. Zeroing the meter removes DC offset from the measurement reading.

**Note:** The Zero function works only when the dial is set to the DC current measurement position. Before zeroing the meter, make sure the jaws are closed and no conductor is inside the jaw.

2. Press the trigger to the open jaw and fully enclose one conductor.

**NOTE:** Only one conductor can be measured at a time.

3. The LCD will display the reading.

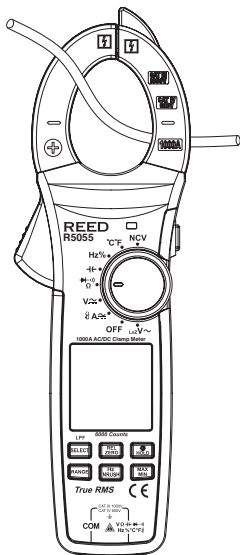

## Current Frequency Measurement

1. While in AC current measurement mode and the meter is under test, press **Hz/INRUSH** button to enter the Frequency measurement mode.
2. The LCD will display the reading.
3. Press the **Hz/INRUSH** button again to exit the Frequency measurement mode.

## Inrush Current Measurement

1. While the device to be tested is turned off, set the rotary function switch to the **A** position.
2. Open the jaw and fully enclose one conductor.

*continued...*

**REED Instruments**

1-877-849-2127 | info@reedinstruments.com | www.reedinstruments.com

3. Press and hold the **HZ/INRUSH** button for 2 seconds to enter the Inrush current measurement mode.
4. Turn on the device under test.
5. The LCD will display the reading.

**NOTE:** Inrush current is the highest AC current (True RMS) within 100ms of start time, as shown below.

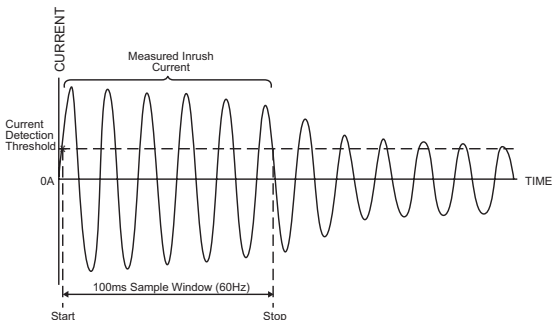

## **AC/DC Voltage Measurements**

1. Insert the black test lead into the negative COM terminal and the red test lead into the positive V terminal.
2. Set the rotary function switch to the **V** position and select either AC or DC by pressing the **SELECT** button.
3. Connect the test leads in parallel to the circuit under test.
4. The LCD will display the reading.

## **Voltage Frequency Measurement**

1. While in AC voltage measurement mode and the meter is under test, press **HZ/INRUSH** button to enter the Frequency measurement mode.
2. The LCD will display the reading.
3. Press the **HZ/INRUSH** button again to exit the Frequency measurement mode.

*continued...*

## Low Pass Filter (LPF) ACV Measurement

1. While in AC voltage measurement mode, press and hold the **SELECT** button to enter the LPF ACV measurement mode.

**NOTE:** Low Pass Filter can measure combined sine wave signals produced by inverters and variable frequency drives, as shown below.



2. Once the LPF ACV function is activated, press the **Hz/INRUSH** to enter the Frequency measurement mode.
3. The LCD will display the reading.
4. Press the **Hz/INRUSH** again to exit the Frequency measurement mode.

## Low Impedance (LoZ) ACV Measurement

1. Insert the black test lead into the negative COM terminal and the red test lead into the positive V terminal.
2. Set the rotary function switch to the LoZ V~ position.
3. Connect the test leads in parallel to the circuit under test.
4. The LCD will display the reading.

## LoZ ACV Frequency Measurement

1. While the rotary function switch is set to the LoZ V~ position and the meter is under test, press the **Hz/INRUSH** button to enter the Frequency measurement mode.
2. The LCD will display the reading.
3. Press the **Hz/INRUSH** again to exit the Frequency measurement mode.

*continued...*

## Resistance Measurement

**NOTE:** Remove power before making resistance measurements.

1. Insert the black test lead into the negative COM terminal and the red test lead into the positive V terminal.
2. Set the rotary function to the  position.
3. Press the **SELECT** button to switch to resistance measurement mode ( $\Omega$ ).
4. Connect the test leads in parallel to the circuit under test. It is best to disconnect one side of the device under test so the rest of the circuit will not interfere with the reading.
5. The LCD will display the reading.

## Continuity Measurement

1. Insert the black test lead into the negative COM terminal and the red test lead into the positive V terminal.
2. Set the rotary function to the  position.
3. Press the **SELECT** button to switch to continuity measurement mode ( $\cdot \Omega$ ).
4. Connect the test leads in parallel to the circuit under test.
5. If the resistance is  $\leq 30\Omega$ , the circuit is in good condition and the device will emit a continuous buzzer sound.

**NOTE:** If the measured resistance is  $\geq 70\Omega$ , the device will not emit a buzzer sound.

## Diode Test

1. Insert the black test lead into the negative COM terminal and the red test lead into the positive V terminal.
2. Set the rotary function to the  position.
3. Press the **SELECT** button to switch to diode test mode ( $\rightarrow \nabla$ ).
4. Connect the red probe to the diode anode, and the black probe to the diode cathode.

*continued...*

- The LCD will display the reading. Forward voltage will indicate 0.5V to 0.8V. Reverse voltage will be indicated by "OL". Shorted devices will indicate near 0mV and an open device will be indicated by "OL" in both polarities.

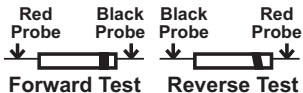

## Capacitance Measurement

- To avoid electric shock, before taking any capacitance measurements disconnect power to the unit under test and discharge all capacitors. Remove the batteries and unplug the line cords.
- Insert the black test lead into the negative COM terminal and the red test lead into the positive V terminal.
- Set the rotary function to the  $\text{M}\text{F}$  position.
- Touch the test leads to the capacitor under test.
- The LCD will display the reading.

**NOTE:** If the measured capacitor is short-circuited or the capacitance exceeds the maximum range, the LCD will display "OL". The analog bar graph is disabled in capacitance measurement mode. When measuring capacitance  $>600\mu\text{F}$ , please allow the meter time to stabilize.

## Frequency/Duty Ratio Measurement

- Insert the black test lead into the negative COM terminal and the red test lead into the positive V terminal.
- Set the rotary function to the **Hz%** position.
- Press the **SELECT** button to switch to Frequency measurement mode (Hz).
- Connect the test leads in parallel to the circuit under test.
- The LCD will display the Frequency reading.
- Press the **SELECT** button again to switch to Duty Ratio measurement mode (%).
- The LCD will display the duty ratio reading.

*continued...*

**REED Instruments**

1-877-849-2127 | info@reedinstruments.com | www.reedinstruments.com



## Contact Temperature Measurement

1. To avoid electric shock, before taking a contact temperature measurement disconnect both test probes from any source of voltage.
2. Set the rotary function to the °C/°F position.
3. Insert the included Temperature Probe into the negative COM and the positive V terminals, making sure to observe the correct polarity.
4. Press the **SELECT** button to change between °C and °F.
5. Place the Temperature probe onto the area being measured. Keep the probe in place until the reading stabilizes (approx. 30 seconds).
6. The LCD will display the reading.

**NOTE:** The meter will display "OL" if there is an open input or a temperature over range. To avoid electric shock, be sure the thermocouple has been removed before changing to another function.

## Non-Contact Voltage (NCV) Detection

1. Set the rotary function to the **NCV** position.

**NOTE:** Remove test leads from the meter prior to attempting NCV tests. Always verify the NCV function on a known live circuit before performing your tests. Do not use the NCV function if the display does not show EF when the function switch is turned to the NCV position. If the meter does not switch on when the NCV mode is initiated, check the batteries.

2. Place the probe near an AC voltage location. If AC voltage is present, the meter will emit an audible beep, the LCD will display dashes "---" and the NCV indicator will light up.

**NOTE:** As the AC voltage signal increases, the frequency of the beeps and the number of dashes on the LCD screen will increase. Receptacles in recessed sockets or differences in socket may result in false readings.

*continued...*

## *Auto and Manual Range*

When the meter is first turned on, it automatically goes into Auto Ranging mode. This automatically selects the best range for the measurement being made and is generally the best mode for most applications. For applications that require a manual range to be set, perform the following:

1. Press the **RANGE** button. The "Auto" range display indicator will turn off.
2. Continuously press the **RANGE** to skip through the available ranges until the required range is selected.
3. Press and hold the **RANGE** button for 2 seconds to exit "Manual Ranging" mode and return to "Auto Ranging".

## *Relative Mode*

Relative mode stores the current measurement reading displayed on the LCD, resets the meter to zero and maintains the stored measurement reading as a reference point for all subsequent measurements.

1. Press the **REL** button to enter relative mode. The **Δ** indicator will appear on the LCD along with the relative reading.
2. Press the **REL** button again to exit relative mode and resume normal operation.

**Note:** The meter does not auto range while relative mode is enabled and does not work under Continuity, Resistance or Diode Test measurement modes.

## *Auto Power Off*

1. To preserve battery life, the meter is programmed to turn off after approx. 15 minutes of inactivity.
2. To turn this function off, press and hold the **SELECT** button while powering on the meter.
3. If the meter is turned off then back on, the "Auto Power Off" feature will be enabled again.

*continued...*

## MAX/MIN Measurement

1. Press the **MAX/MIN** button to select the maximum reading as indicated by the "MAX" symbol. The Max value is updated when a new maximum data value has been attained.
2. Press the **MAX/MIN** button again to select the minimum reading as indicated by the "MIN" symbol. The Min value is updated when a new minimum data value has been attained.
3. Press and hold the **MAX/MIN** button to exit and resume normal operation.

## Data Hold

1. While taking a measurement, press the **HOLD** button to freeze the current reading on the display.
2. While in this mode, an "H" symbol will appear.
3. Press the **HOLD** button again to exit and resume normal operation.

## Backlight

Press and hold  the button to turn the LCD Backlight on and off.

## Battery Replacement

1. Remove the Phillips screw on the back of the meter.
2. Open the battery compartment.
3. Replace the 3 X AAA batteries.
4. Properly secure the cover and tighten the screw.

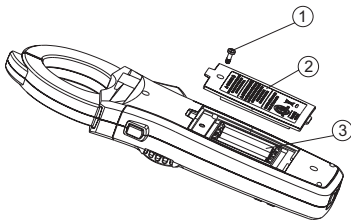

## Applications

- Industrial maintenance teams performing scheduled and preventative maintenance on electro-mechanical equipment and systems.
- Facilities, building maintenance and electricians looking to troubleshoot electrical equipment installation problems.

## Accessories and Replacement Parts

- **R5400** Line Splitter
- **R2990** Thermocouple Adapter
- **R2920** Surface Thermocouple Probe
- **R2930** Right Angle Thermocouple Surface Probe
- **R2940** Air/Gas Thermocouple Probe
- **R2950** Immersion Thermocouple Probe
- **R2960** Needle Tip Thermocouple Probe
- **R1020** Fused Test Lead Set
- **R1000** Safety Test Lead Set
- **CA-05A** Medium Soft Carrying Case

Don't see your part listed here? For a complete list of all accessories and replacement parts visit your product page on [www.reedinstruments.com](http://www.reedinstruments.com).

## Appendix A

### Flexible AC Current Probe Measurement (R5065 sold separately)

#### *AC Current Measurement with Flexible Probe*

1. Insert the flexible current probe into the negative COM terminal and the red test lead into the positive V terminal.
2. Connect the probe's flexible tubing around the conductor under test. If you are opening the end of the flexible probe to make the connection, be sure to close and lock it back into place.
3. Keep the probe coupling more than 1" (2.5cm) away from the conductor.

*continued...*

**REED Instruments**

1-877-849-2127 | [info@reedinstruments.com](mailto:info@reedinstruments.com) | [www.reedinstruments.com](http://www.reedinstruments.com)

- Turn on the flexible probe by setting the required current range.

**NOTE:** When measuring current, center the conductor in the flexible current Probe. If possible, avoid taking measurements close to other current-carrying conductors.

- Set the rotary function switch to the  $\text{A}$  position.
- The meter will automatically switch to the flexible current probe with the extended current range.
- The LCD will display the reading.

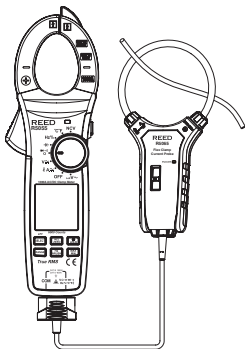

### **AC Current Frequency Measurement with Flexible Probe**

- Insert the flexible current probe into the negative COM terminal and the red test lead into the positive V terminal.
- Connect the probe's flexible tubing around the conductor under test. If you are opening the end of the flexible probe to make the connection, be sure to close and lock it back into place.
- Turn on the flexible probe by setting the required current range.
- Set the rotary function switch to the  $\text{A}$  position.
- The meter will automatically switch to the flexible current probe with the extended current range.
- Press **Hz/INRUSH** button to enter the Frequency measurement mode.
- The LCD will display the reading.
- Press the **Hz/INRUSH** button again to exit the Frequency measurement mode.

*continued...*

## Inrush AC Current Measurement

1. Insert the flexible current probe into the negative COM terminal and the red test lead into the positive V terminal.
2. Connect the probe's flexible tubing around the conductor under test. If you are opening the end of the flexible probe to make the connection, be sure to close and lock it back into place.
3. Turn on the flexible probe by setting the required current range.
4. While the device to be tested is turned off, set the rotary function switch to the  $\text{A} \approx$  position.
5. The meter will automatically switch to the flexible current probe with the extended current range.
6. Press and hold the **HZ/INRUSH** button for 2 seconds to enter the Inrush current measurement mode.
7. Turn on the device under test.
8. The LCD will display the reading.

**NOTE:** Inrush current is the highest AC current (True RMS) within 100ms of start time, as shown below.

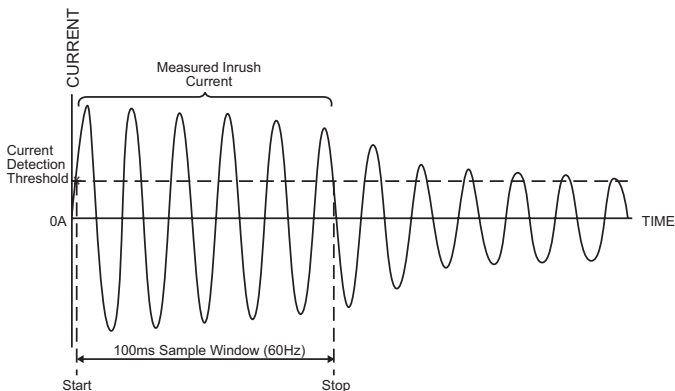

## Product Care

To keep your instrument in good working order we recommend the following:

- Store your product in a clean, dry place.
- Change the battery as needed.
- If your instrument isn't being used for a period of one month or longer please remove the battery.
- Clean your product and accessories with biodegradable cleaner. Do not spray the cleaner directly on the instrument. Use on external parts only

## Product Warranty

REED Instruments guarantees this instrument to be free of defects in material or workmanship for a period of one (1) year from date of shipment. During the warranty period, REED Instruments will repair or replace, at no charge, products or parts of a product that proves to be defective because of improper material or workmanship, under normal use and maintenance. REED Instruments total liability is limited to repair or replacement of the product. REED Instruments shall not be liable for damages to goods, property, or persons due to improper use or through attempts to utilize the instrument under conditions which exceed the designed capabilities. In order to begin the warranty service process, please contact us by email at 1-877-849-2127 or [info@reedinstruments.com](mailto:info@reedinstruments.com) to discuss the claim and determine the appropriate steps to process the warranty.

## Product Disposal and Recycling



Please follow local laws and regulations when disposing or recycling your instrument. Your product contains electronic components and must be disposed of separately from standard waste products.

## Product Support

If you have any questions on your product, please contact your authorized REED distributor or REED Instruments Customer Service by phone at 1-877-849-2127 or by email at [info@reedinstruments.com](mailto:info@reedinstruments.com).

Please visit [www.REEDInstruments.com](http://www.REEDInstruments.com) for the most up-to-date manuals, datasheets, product guides and software.

*Product specifications subject to change without notice.  
All rights reserved. Any unauthorized copying or reproduction of this manual is strictly prohibited without prior written permission from REED Instruments.*