

REED

Model R5050

TRMS AC/DC Clamp Meter

Instruction Manual



www.reedinstruments.com

Table of Contents

| | |
|------------------------------|------|
| Safety | 3 |
| Features..... | 4 |
| Specifications..... | 4-6 |
| Instrument Description | 7-8 |
| Measurement Procedures | 9-12 |
| Battery Replacement..... | 13 |
| Product Maintenance | 13 |

For service on this or any other REED product or information on other REED products, contact REED Instruments at info@reedinstruments.com.



Safety

- Read this manual before using the meter and follow all safety guidelines.
- Use the meter only as specified in this instruction manual. Otherwise the meters protection may be impaired.
- Never use this meter on a circuit with voltages greater than 750Vrms @ 50/60 Hz.
- Do not operate the meter if the body or test leads look damaged.
- Check the function selector range switch and make sure it is at the correct position before each measurement is taken.
- Do not perform resistance and continuity tests on a live circuit.
- Exercise extreme caution when measuring live systems with voltages greater than 60VCC or 30VCA.
- Use extreme care when working around bus bars and bare conductors.
- Do not use the meter in over range/overload conditions (OL).
- Change the battery when the  symbol appears to avoid incorrect readings.

Environmental Conditions

Altitude up to 2000 meters.

Operating Temperature: 0°C ~ 40°C, <80% RH, non-condensing

Storage Temperature: -10°C ~ 60°C, <70% RH, battery removed

Pollution Degree: 2

Installation Categories III (600V), II (1000V)

Symbols



Attention! Refer to operation Instructions.



Dangerous voltage may be present at terminals.



This instrument has double insulation.



Approvals:  EN61010 600V CAT III 1000V CAT II

When servicing this meter, use only specified replacement parts. For service (repairs or calibration) on this or any other REED product or information on other REED products, contact REED Instruments at info@reedinstruments.com.

Features

- True RMS measurements
- 3-3/4 digit LCD with high-speed, 42-segment bargraph
- Max/Min and Data Hold functions
- Peak Hold function
- Frequency measurement
- Diode and continuity test with beeper
- Polarity and overload indications
- Auto or manual ranging
- Auto power-off
- Low battery indication

Specifications

| | |
|-------------------------|--|
| Digital Display: | 3 3/4 digits LCD display with maximum reading 3999 |
| Analog Display: | Fast 40 segment analog bar graph display |
| Symbol & Scale Range: | Automatic display according symbols and range input signal |
| Polarity: |  is displayed when negative signal applied to the input |
| Over Load: |  is displayed when input signal exceeds range |
| Sample Rate: | 2 times/sec for digital data; 20 times/sec for analog bar |
| Low Battery Indication: |  is displayed when the battery is below the required voltage |
| Auto Power Off: | By default, the meter is in auto power off mode. The meter will power itself off after 30 minutes without operation. To disable the auto power off, press and hold the "MAX/MIN" button and turn the meter on. |
| Jaw Opening: | 40mm |
| Power Supply: | 9V, NEDA1604 or 6F22 or 006P |
| Battery Life: | 40 hours typically (Alkaline) |
| Dimensions (L x W x H): | 9.53 x 2.60 x 1.4" (242 x 66 x 36 mm) |
| Weight: | 400g (14.10 oz) with battery |
| Includes: | Carrying case, test leads, 9V battery and instruction manual |
| Optional Accessories: | Fused Test Leads (FC-300) |

continued ...

Electrical Specifications

The accuracy specification is defined as \pm (...% of reading+ ...count) at $23\pm 5^{\circ}\text{C}$, $\cong 80\% \text{RH}$

TRMS for ACV and ACA accuracy are specified from 5% to 100% of the range. For the accuracy add \pm (1% of reading) on Crest Factor $1.4 < \text{CF} < 3$ at full scale & $\text{CF} < 6$ at half scale.

ACA

| Range | Resolution | Accuracy | | Overload Protection |
|-------|------------|-----------------------------|-----------------------------|---------------------|
| 40A | 0.01A | \pm (1.9% rdg + 5 digits) | 50 ~ 60Hz | 1200Arms |
| 400A | 0.1A | | 60 ~ 500Hz | |
| 1000A | 1A | | \pm (2.5% rdg + 5 digits) | |

DCA

| Range | Resolution | Accuracy | Overload Protection |
|-------|------------|----------------------------------|---------------------|
| 40A | 0.01A | \pm (2.5% reading + 10 digits) | 1200Arms |
| 400A | 0.1A | | |
| 1000A | 1A | | |

ACV (Autorange)

| Range | Resolution | Accuracy | Overload Protection |
|-------|------------|---|---------------------|
| 400V | 0.1V | \pm (1.5% reading + 5 digits) 50 ~ 500Hz | 1000Vrms |
| 750V | 1V | | |

DCV (Autorange)

| Range | Resolution | Accuracy | Overload Protection |
|-------|------------|-------------------------------|---------------------|
| 400V | 0.1V | \pm (1% reading + 2 digits) | 1000Vrms |
| 1000V | 1V | | |

Ohm (Resistance) (Autorange)

| Range | Resolution | Accuracy | Overload Protection |
|---------------|--------------|-------------------------------|---------------------|
| 400 Ω | 0.1 Ω | \pm (1% reading + 2 digits) | 600Vrms |
| 4000 Ω | 1 Ω | | |

continued ...

→+ (Diode)

| Range | Test Current | Open Circuit Voltage | Overload Protection |
|-------|--------------|----------------------|---------------------|
| →+ | 1.7mA Max. | 6V Max. | 600Vrms |

•))) Continuity

| Range | Active Region | Overload Protection |
|-------|---------------|---------------------|
| •))) | <100Ω | 600Vrms |

Frequency (Hz) (Autorange)

| Function | Range | Resolution | Sensitivity | Accuracy |
|----------|-------|------------|-------------|---------------------------------------|
| A-Hz | 4KHz | 1Hz | 2Arms | ±(0.1% reading + 1 digits) (20~10KHz) |
| | 10KHz | 10Hz | 5Arms | |
| V-Hz | 4KHz | 1Hz | 5Vrms | ±(0.1% reading + 1 digits) (10~10KHz) |
| | 10KHz | 10Hz | 10Vrms | |

Instrument Description

- 1 — Current Sensing Clamp
- 2 — Clamp opening handle
- 3 — Function select dial
- 4 — Hold Button
- 5 — Peak Hold Button
- 6 — Maximum Minimum Button
- 7 — AC/DC Select Button
- 8 — Relative Button
- 9 — LCD Display
- 10 — “COM” Terminal
- 11 — “+” Test Terminal

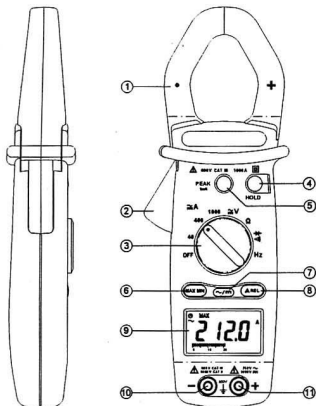

Display

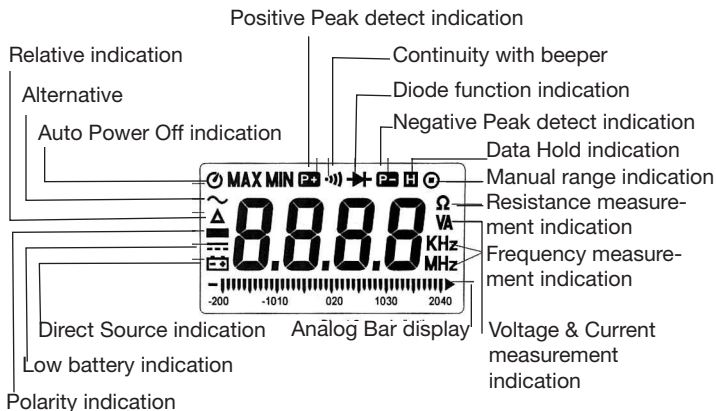

continued ...

Data Hold Function

Press the “**HOLD**” button at any time to hold the current reading. To release the data being held, simply press the “**HOLD**” button again.

Peak Hold Function

This meter is designed with 1ms peak hold function at ACA, ACV, DCA and DCV ranges. Before performing a peak hold operation, a calibration process must be completed first.

To do this, press and hold the peak button for 2 seconds. “**CAL**” will display on the LCD and the offset will be calculated and kept in the meter.

After the calibration is complete, you can choose P+ or P- by pressing the “**PEAK + HOLD**” button to keep the peak reading. To return the meter back to normal operation, press the “**PEAK**” button for 2 seconds.

When the function range changes, the meter will require another calibration for peak measurement.

MAX/MIN Function

This meter is designed with a MAX/MIN function at ACA, ACV, DCA and DCV ranges.

Press the “**MAX/MIN**” button once to set the meter to the MAX mode. Press it once again to set the meter to MIN mode. Press it once again and the meter will display the present reading and will continue tracking the MAX and MIN changes. This mode will also be indicated with the blinking “**MAX MIN**” symbol.

Set the meter back to normal operation by pressing the “**MAX/MIN**” button for more than 2 seconds.

REL Function:

This meter is designed with REL function at ACA, ACV and DCV, DCA ranges.

Press the “**REL**” button to change the zero to the current reading and the relative value will show on the LCD. Press it once again and the meter will display the relative zero point. This mode will also be indicated with a blinking “**REL**” symbol.

Set the meter back to normal operation by pressing the “**REL**” button for more than 2 seconds.

Measurement Procedures

Current Measurement

Switch the main function selector to proper current range.

ACA

Open the clamp by pressing the jaw-opening handle and insert the cable to be measured into the jaw. Choose AC current measurement by pressing the “**AC/DC**” button for ACA readings.

DCA

To measure DC current, choose DC measurement by pressing the “**AC/DC**” button. Wait for the reading to stabilize then press the “**REL**” button to reset the reading. Once completed, insert the cable to be measured into the jaw and read the value.

Notes: Before taking this measurement, disconnect the test leads from the meter for safety. If the reading is difficult to read, push the “**HOLD**” button and read the result later.

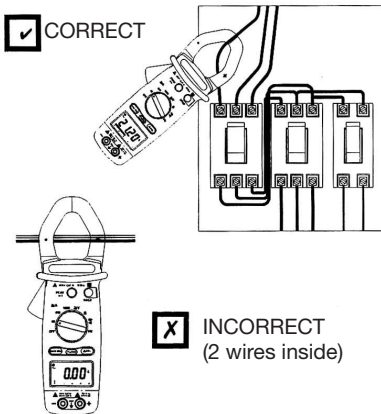

continued ...

Voltage measurement

Switch the main function selector to Voltage Range. Connect the Red test lead to the “+” terminal and the Black one to the “COM” terminal. Choose AC or DC by pressing the AC/DC button. Measure the voltage by touching the test lead tips to the test circuit where the value of voltage is needed. Read the result on the LCD panel.

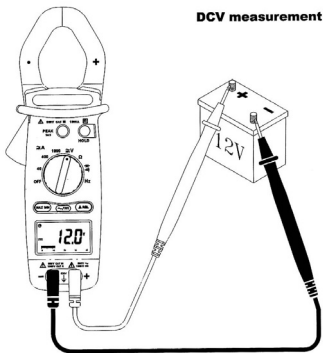
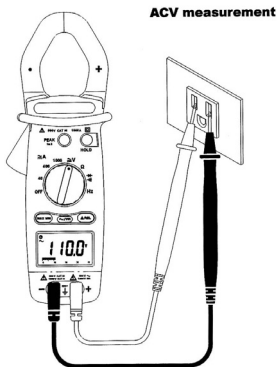

Resistance measurement

Switch the main function to the “ Ω ” range, verify that the power line is disconnected from the system. Connect the Red test lead to the “+” terminal and the Black one to the “COM” terminal. Connect the tips of the test leads to the points where the value of the resistance is needed. Read the result on the LCD panel.

Note: When measuring the resistance value of a circuit system, make sure the power is off and all capacitors required are discharged.

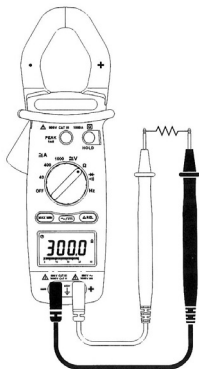

continued ...

Continuity Test

Switch the main function to the “ \rightarrow \vdash \curvearrowright ” range, verify that the power line is disconnected from the system. Connect the Red test lead to the “+” terminal and the Black one to the “COM” terminal. Connect the tips of the test lead to the points where the value of the conduction condition is needed. If the resistance is under 100Ω , the beeper will sound continuously.

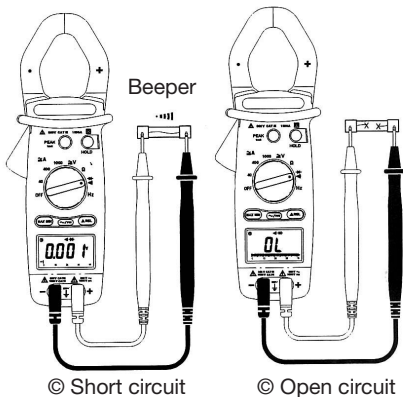

Diode Test

Switch the main function to the “ \rightarrow \vdash \curvearrowright ” range, verify that the power line is disconnected from the system. Connect the Red test lead to the “+” terminal and the Black one to the “COM” terminal. Connect the tips of the Red test lead to the anode side and the Black test lead to the cathode side of the diode being tested. Read the forward Voltage (Vf) value on the LCD panel.

If the polarity of test leads are reversed with diode polarity, the digital reading will show “OL”. This can be used for distinguishing between anode and cathode terminals of a diode.

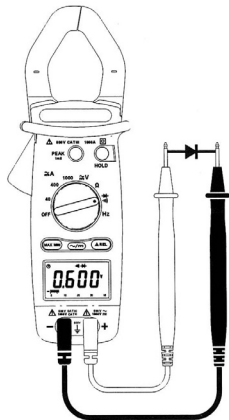

continued ...

Frequency measurement from the terminals

Switch the main function to the “Hz” range. Connect the Red test lead to the “+” terminal and the Black one to the “COM”. Connect the tips of the test leads to the points where the frequency of the voltage signal is required. Read the value on the LCD panel.

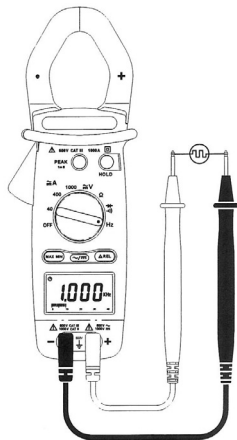

Frequency measurement with the clamp

Switch the main function to the “Hz” range. Open the clamp by pressing the clamp-opening handle and insert the cable to be measured into the clamp. Close the clamp and you will find the reading on the LCD panel.

Note: When taking frequency measurements, you should either use the terminal signal or clamp signal but not both. If both sources are applied an error reading will occur.

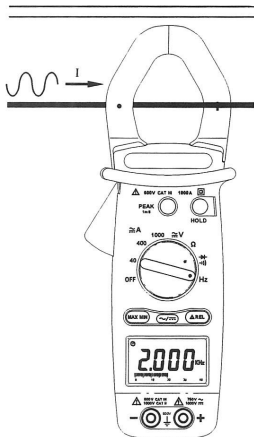

Battery Replacement

- 1) When the battery voltage drops below the proper operation range the  symbol will appear on the LCD display, indicating that the battery needs to be changed.
- 2) Before changing the battery, switch the main function to “OFF” and disconnect the test leads.
- 3) Open the back cover using a screwdriver.
- 4) Replace the old battery with a new 9V battery.
- 5) Close the back cover and fasten the screws using a screwdriver.

Product Maintenance



WARNING!

Before opening the meter, disconnect both test leads and never use the meter before the cover has been reinstalled and fastened.

To avoid contamination or static damage, do not touch the circuit board without proper static protection.

Notes:

- If the meter is not going to be used for a long time, take out the battery and do not store the meter in high temperature or high humidity environment.
- When taking current measurements, keep the cable at the center of the clamp to yield a more accurate test result.
- Repairs or servicing not covered in this manual should be performed only by qualified personal.
- To clean the meter, periodically wipe the case with a dry cloth. Do not use abrasives or solvents on these instruments.

For service (repairs or calibration) on this or any other REED product or information on other REED products, contact REED Instruments at info@reedinstruments.com.

Notes

Notes _____
