



# NEW!

## Get more tools in a smaller calibrator

Carry eight single function calibrators  
**plus** a milliamp calibrator with loop supply  
**plus** a loop troubleshooter in the palm of your hand!

Milliamp • Voltage • Frequency • pH  
Ohms • Thermocouples • RTDs • Pressure  
Loop Diagnostics • Transmitter Supply

### First calibrator with FIVE troubleshooting tools

- 1 Detect 'hidden' loop problems**  
Quickly diagnose troublesome ground faults & current leakage with patented **Loop Diagnostic** technology. *These problems are undetectable with other instruments!*
- 2 Check all loop parameters at once with the LoopScope™**  
Simultaneously displays current, voltage and resistance to let you know the condition of a live loop. Finds problems with power supplies & loops with too many loads. *Patented by PIE!*
- 3 Automatically detect 2, 3 or 4 wire RTDs**  
Trouble shoot sensor connections and find broken wires with *patented technology*. LCD indicates which of the four wires are connected to an RTD sensor.
- 4 Swap out faulty transmitters to diagnose control issues**  
Easily setup the 830 as a universal isolated transmitter for temperature, frequency, millivolt or pressure. If the loop is back under control you know the transmitter was faulty. Turn on the LoopScope to simultaneously see the loop current, power supply voltage and loop loads for troubleshooting.
- 5 Troubleshoot wiring problems without a multimeter**  
Built in continuity checker with 'beeper' quickly finds broken wires or shorts in instrumentation wiring. Also handy for checking operation of relays and controller outputs.

The PIE Model 830 is more than a multifunction calibrator. It is also a loop detective that is able to diagnose common problems that other test equipment just can't find. Have a flooded junction box or unknown ground faults? Our Loop Diagnostic technology will detect it. Or use the *LoopScope* to see at a glance all the parameters - milliamps, voltage and resistance - in the loop.

Stop throwing away perfectly good transmitters only to find the problem is somewhere else in the loop. Setup the PIE Model 830 as an isolated universal transmitter and turn on the Loop Diagnostics. The display will tell you EXACTLY the sensor input, the current output and if there is any uncontrolled current in the loop due to a ground fault, corrosion bridge or moisture. If the control system sees no problem when the 830 is acting as a transmitter THEN you can replace the faulty transmitter. With RTDs the 830 automatically detects which of the 2, 3 or 4 wires are connected and unbroken quickly alerting you to a sensor problem. Diagnostic features are covered by US Patent #7,248,058.

Become a troubleshooting technician with Patented Diagnostic Technology - Available only with PIE Calibrators!



Actual Size



## Easy to use Multifunction Calibrator

### • Technician friendly operation

Intuitive *EZ-DIAL Double Click Menu* makes it easier to setup than other multifunction calibrators. As easy to use as single function PIE Calibrators. Turn on the backlight to easily see the display in dark areas of the plant. Connections diagrams are indicated on the display for each function along with a labeled connector and a help chart behind the tilt stand.

### • Calibrate with Confidence

Accurate to  $\pm 0.02\%$  of Reading + 0.01% Full Scale.

### • Measure temperature sensors, frequency pickups, loop currents, voltage levels & pressures

Check the values of your process sensors. Instantly recall MAX and MIN values to see process variability.

### • Guaranteed Compatibility with process inputs

Compatible with the instruments you use including all brands of smart transmitters and PLCs with 14 T/C and 9 RTD types to 0.1°C and 0.1°F

### • Quickly set any three outputs plus automatic stepping & ramping

Easily set any value with the adjustable "DIAL" plus store any three output settings for instant recall with the EZ-CHECK™ switch. 2, 3, 5 & 11 steps automatically increment output in 100%, 50%, 25% or 10% of span plus continuous ramp. Set step/ramp time to 5, 6, 7, 8, 10, 15, 20, 25, 30 & 60 seconds.



## Milliamp Calibrator

### • Easy to use

With the 830 you can check, calibrate and measure all of your current signal instruments in a 4 to 20 milliamp DC loop. It can be used at any access point in your loop. Source & Read 0.000 to 24.000 mA, Simulate a 2 Wire Transmitter or use the 830 to simultaneously power your 2 Wire Transmitter and measure its output.



### • Source milliamps

Calibrate recorders, digital indicators, stroke valves or any instruments that get their input from a 4 to 20 mA loop. Easily set any value quickly to within 0.001 mA with the adjustable digital potentiometer "EZ-DIAL" or use preset **4.000 mA (0.00%)** and **20.000 mA (100.00%)** EZ-CHECK™ settings.

### • Calibrate using loop power

Check loop wiring and receivers by using the 830 in place of a 2 Wire transmitter. Uses any loop power from 2 to 60 V DC.

### • Read loop current

Check controller outputs or measure the milliamp signal anywhere in the loop. The 830 measures 0.000 to 24.000 mA (-25.00 to 125.00%) signals with greater accuracy than a typical multimeter.

### • Power & measure 2 wire transmitters

The 830 can simultaneously output 24V DC to power any and all devices in a process loop using the internal batteries and internal switching power supply, while measuring the output of a 2 Wire Transmitter and any other loop devices. Powers HART™ transmitters with built-in 250 ohm resistor simplifying hookups with HART communicators.

## Voltage Calibrator

### • Source three ranges of mV & V dc

With the 830 you can check, calibrate and measure all your voltage, millivolt and pH signal instruments in your plant. Source 0.000 to 10.250 V dc, -500.00 to 999.99 mV and -20.000 to 99.999 mV.



### • Read DC volts

The 830 can measure from 0.000 to 10.250 V, -999.99 to 999.99 mV, -99.999 to 99.999 mV and 0.00 to 60.0 VDC. Use it to check loop power supplies, I/V converters, 1 to 5 Volt signals, and other voltages.

## Frequency Calibrator

### • Calibrate flow meters and frequency instruments

Generate zero crossing square waves to check, calibrate and measure all the frequency signal instruments in your plant. Source and read frequencies from 1 to 2000 CPM (Counts-Per-Minute), 0.01 to 999.00 Hz, 0.1 to 9999.9 Hz and 0.001 to 20.000 kHz.

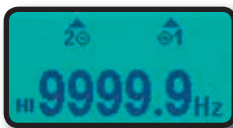

### • Checkout optical pickups

The 830 has a green LED that flashes in sync with the output frequency. Select a frequency and hold the calibrator up to the optical sensor.

### • Measure frequency signals

Check the values of your process frequency outputs. Instantly recall MAX and MIN values to see process variability.

## Thermocouple Calibrator

- **Calibrate directly in temperature to 0.1°C & 0.1°F**

Stop carrying around a millivolt source and thermocouple tables. The 830 works with the thermocouples you use including types J, K, T, E, R, S, B, N, G, C, D, L (J-DIN), U (T-DIN) and P (Platinel II). Easily set any value quickly to within 0.1° with the adjustable digital potentiometer “EZ-DIAL” plus recall any three temperatures for instant recall with the EZ-CHECK™ switch.



- **Measure thermocouple sensors**

Trouble shoot sensor connections and find broken wires or corroded connections. Connect your thermocouple with a miniature thermocouple connector and the 830 measures the probe to 0.1 degree C or F. Check the values of your process sensors. Instantly recall MAX and MIN values to see process variability.

## RTD, Resistance Calibrator

- **Calibrate ALL your RTD instruments**

With the 830 you can check & calibrate all your RTD instruments and measure RTD Sensors.

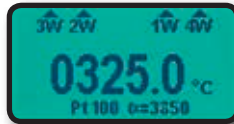

- **Calibrate directly in temperature (°C & °F)**

Stop carrying around a decade box and RTD resistance tables. The 830 works with the RTDs you use including Platinum 100 (alpha = 3850, 3902, 3916, 3926) & 1000 (alpha = 3850) Ohm, Copper 10 & 50 Ohm, Nickel 100 and 120 Ohm. Easily set any value quickly to within 0.1° with the adjustable digital potentiometer “EZ-DIAL” plus store any three temperatures for instant recall with the EZ-CHECK™ switch. Or use like a decade box from 0.00 to 401.00 and from 0.0 to 4001.0 Ohms.

- **Compatible with ALL process instruments**

No competitor's calibrator is compatible with as many process instruments! Connect directly to the RTD inputs of smart transmitters, PLCs, DCS and multichannel recorders and verify their outputs or displays. Works with older instruments with fixed excitation currents and newer multichannel instruments that switch the excitation current between input channels.

- **Measure RTD sensors**

Connect your two, three or four wire RTDs and the 830 measures the RTD within 0.1 degree C or F. The PIE 830 uses a patented circuit to automatically detect and measure 2, 3 or 4 wire RTD sensors. The connections are shown on the display to help you troubleshoot shorts or opens in the sensor's wiring. Check the values of your process sensors. Instantly recall MAX and MIN values to see process variability.

## pH Simulator

- **Simulate pH probes into transmitters & analyzers**

Use the pH simulator to verify proper operation of pH devices before you place a probe into a calibrated buffer. Adjusting the pH transmitter or analyzer without a probe allows you to make sure the device is calibrated and doesn't require too much offset with the probe. If the probe requires more than the manufacturer's

recommendations (typically 5%) it is time to replace the probe. The 830 simulates 0.000 to 14.000 pH @ 25°C corresponding to +414.12 to -414.12 mV.



## Calibrate 2 Wire Transmitters

- **Power & measure 2 wire transmitters**

The 830 can simultaneously simulate the temperature, frequency, pH or pressure input to a transmitter while outputting 24V DC to power the transmitter using the internal batteries and internal switching power supply while displaying the output of the 2 Wire Transmitter. Powers HART™ transmitters with built-in 250 ohm resistor simplifying hookups with HART communicators.

With LEAK DETECT enabled the 830 indicates when there is a ground fault in the loop or an internal problem with the transmitter allowing unregulated current to pass through causing offsets in the loop current.

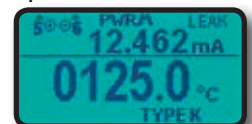
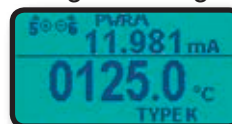

## Continuity Checker

- **Troubleshoot wiring and connection problems**

Use the built-in continuity checker to look at wiring and connections during installation or to locate shorts. Beeps from 0 to 100 Ohms.





## Troubleshoot Loop Problems

### • Find current leaks in loops before swapping instruments

Automatic indication of Loop Current and Leakage Current (US Patent #7,248,058). Measure ground current leakage from faulty wiring, flooded conduit and corrosion bridges to help you decide if there is a wiring problem in the loop (diagrams below).

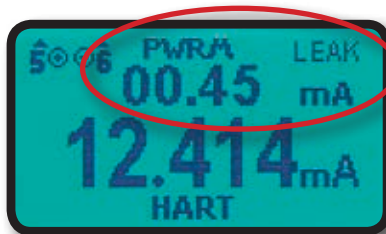

830 detects uncontrolled current in the loop due to a flooded junction box.

## Typical problem found with Leak Detection

Have you ever replaced a “faulty” transmitter only to find the problem was somewhere else in the loop? And did you end up throwing the transmitter away after you fixed the other problem “just in case” the transmitter was faulty?

If you find a loop where the transmitter is calibrated correctly but all the readings elsewhere in the loop have a fixed offset this is due to a *Zero Shift*. This zero shift is typically caused by some current in the loop bypassing the transmitter. This might be caused by ground faults, moisture or corrosion.

If you have some loops that are erratic after it rains there may be moisture present in a junction box or where insulation has broken down. Turn on Ground Leak Detection and use the PIE 830 to power up the loop. Any current that isn't controlled by the transmitter or other current control element will be indicated as leakage on the PIE 830 display. Undetected current leaks may cause calibration errors which can lead to dangerous operating conditions or catastrophic results.

The PIE 830 powers up the 2-Wire transmitter or loop and indicates the total current and the uncontrolled current. This provides information useful in troubleshooting loop errors.

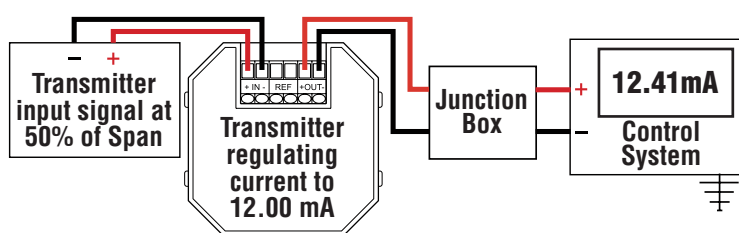

Here is a loop where a technician has just recalibrated the transmitter but the control room still sees a problem. The problem started just after a rainstorm.

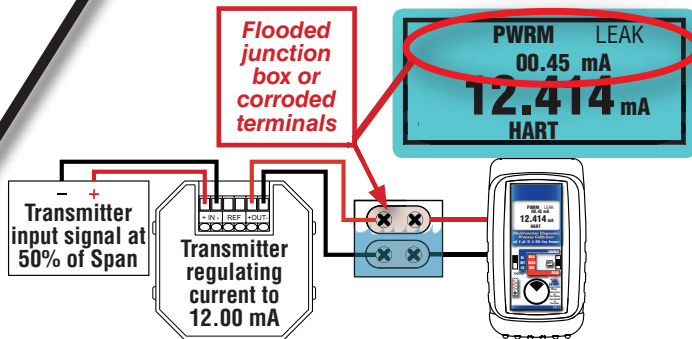

Using the PIE 830 to power up the loop the technician detects a leakage of 0.45 mA - approximately the offset seen in the control room. He walks the loop and opens a junction box releasing a stream of water. The loop is again in control.

## Become a Loop Detective - Locate hidden loop problems with LoopScope

When you need to find out why a loop is out of control and all the wiring seems to be in order turn on the 830's LoopScope and simultaneously see all the parameters of the loop. The LoopScope simultaneously displays the current, DC voltage and total resistance in the loop. Observing the SUPPLY (DC voltage) and the LOAD (resistance) lets you see if the loop power supply has enough capacity to power all the devices in the loop.

By observing all three signals at the same time you can see how the voltage and resistance respond as the current changes. If the voltage drops too far as the current goes up you may need a power supply with more capacity or the power supply itself may be failing. If the resistance in the loop is too high you may have more devices in the loop than the power supply can handle or there may be an instrument in the loop that is drawing too much power and requires replacement.

## Troubleshoot Transmitter Problems

- **Find out if your control problems are due to a faulty transmitter**

If a loop is having problems and you suspect the transmitter you can quickly swap it out for the PIE 830 configured as a *universal isolated transmitter*.

The PIE 830 is easily setup as a thermocouple, RTD, frequency, millivolt or pressure transmitter. Simply set it to read, choose your sensor type, select linearized, non-linearized or square root operation, upscale or downscale burnout, and store the endpoints into the XMTR MIN & MAX memories.

Now you can check out the loop, locally and at the control room, and see if replacing the transmitter fixed the problem. If the problem is fixed you may leave the PIE 830 in place while you go to the shop to obtain and configure a replacement transmitter.



*Use the 830 as an Emergency Transmitter Replacement to keep the loop running while you grab a replacement from stock and configure it.*

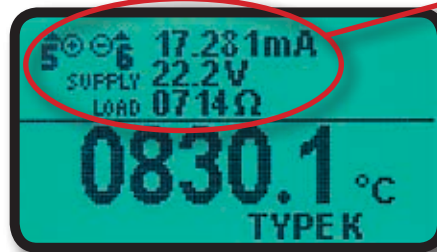

*With LoopScope running the 830 simultaneously displays the sensor input along with the loop current, power supply voltage and loop load in ohms.*

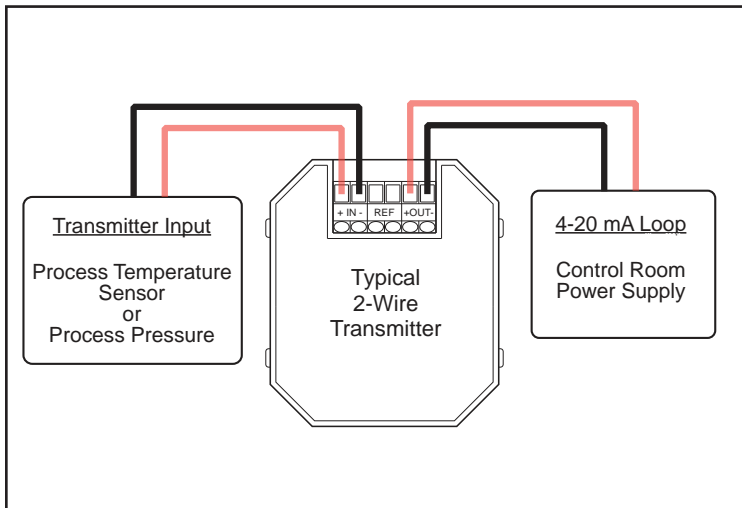

Typical loop with 2-Wire Transmitter

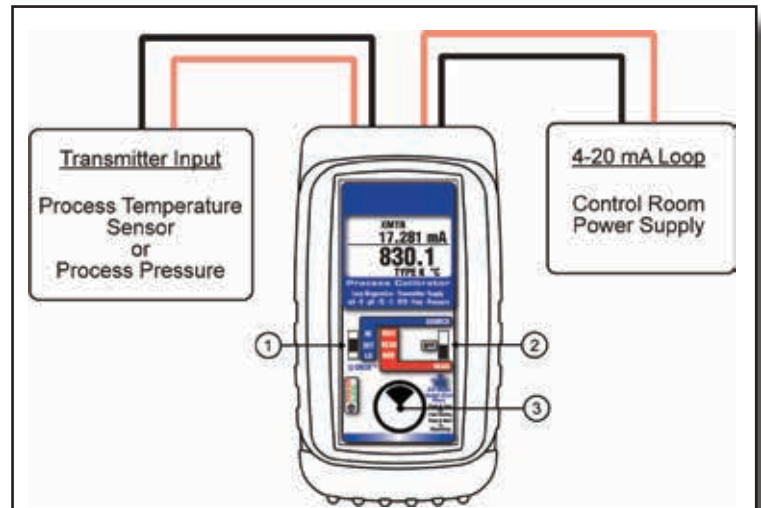

Typical loop with PIE 830 in place of Transmitter

### Why buy a PIE calibrator with loop diagnostics

Undiagnosed loop problems often cause calibration errors which can lead to dangerous operating conditions or catastrophic results. The PIE 830 is the *only multifunction calibrator* that can detect and indicate these problems due to the patented troubleshooting features.

## Evolutionary Design

- **Designed for you by experienced calibrator manufacturers**

PIE Calibrators are designed and built by members of the same team that designed and built the calibrators manufactured by Fluke\* under the Altek\* label. The 830 improves upon other brands by including a rubber boot, backlit display with larger digits, troubleshooting tools, higher accuracy and more ranges for flexibility.

\* PIE Calibrators are not manufactured or distributed by Fluke Corp or Altek Industries Inc, manufacturers of Altek Calibrators.

## Ordering Information

Description	Part No
PIE Model 830 Process Calibrator .....	PIE Model 830

### Included:

Four "AA" Alkaline batteries, Certificate of Calibration	
Blue Rubber Boot .....	020-0213
Evolution Hands Free Carrying Case .....	020-0211
Evolution mA/V Test Leads .....	020-0207
1 Red & 1 Black Lead with Banana Plugs & Alligator Clips	
Evolution RTD Wire Kit .....	020-0208
2 Red & 2 Black Leads with Banana Plugs & Spade Lugs	

## Accessories

### Optional

Three Year Repair/Replacement Warranty.....	RP-WAR-B
Ni-MH 1 Hour Charger with 4 Ni-MH AA Batteries .....	020-0103
(100-120 V AC input for North America Only)	
Evolution Hands Free Carrying Case with Pressure Module Pocket.....	020-0233*
*This case will be substituted for the Hands Free Case without the Module Pocket (020-0211) when the 830 is ordered with a pressure module	

### Optional Hand Pumps, Tubing & Fitting Kits

APOV 0-300 PSI/20.7 bar Pneumatic Scissor Hand Pump .....	020-0224
HPOV 0-3000 PSI/206.9 bar Hydraulic Scissor Hand Pump.....	020-0225
DPPV 0-125 PSI/8.6 bar Pressure, 23"/584 mm Hg Vacuum hand pump .....	020-0226
1/8" male NPT x Male Quick-Test™ Fitting with Cap.....	020-0227
Adapter kit (1/8" MNPT&FNPT; 1/4" MNPT, FNPT & Tube Adapter) .....	020-0228
Quick-Test™ 6900 psi/475 bar hose, 3ft (1 m) .....	020-0229
PKIT1 (020-0224 Pneu Scissor Pump, 020-0229 Hose & 020-0227 fitting).....	020-0230
PKIT2 (020-0225 Hydr Scissor Pump, 020-0229 Hose & 020-0227 fitting) .....	020-0231
PKIT3 (020-0226 Press/Vac Pump, 020-0229 Hose & 020-0227 fitting) .....	020-0232

### Optional Pressure Modules

0-10"/24.9 mbar H2O Differential, Non Isolated.....	DN0010
0-28"/69.7 mbar H2O Differential, Non Isolated.....	DN0028
0-200"/498 mbar H2O Differential, Non Isolated.....	DN0200
0-415"/1 bar H2O Differential, Non Isolated.....	DN0415
0-2000"/5 bar H2O Differential, Non Isolated.....	DN2000
0-1 PSI/68.9 mbar Differential, Isolated.....	DI0001
0-5 PSI/344.7 mbar Differential, Isolated.....	DI0005
0-15 PSI/1 bar Differential, Isolated.....	DI0015
0-30 PSI/2 bar Differential, Isolated.....	DI0030
0-100 PSI/6.9 bar Differential, Isolated.....	DI0100
0-300 PSI/20.7 bar Differential, Isolated.....	DI0300
0-500 PSI/34.5 bar Differential, Isolated.....	DI0500
0 to 15 PSI/1 bar Gauge, Isolated.....	GI0015
0 to 30 PSI/2 bar Gauge, Isolated.....	GI0030
0 to 50 PSI/3.4 bar Gauge, Isolated.....	GI0050
0 to 100 PSI/6.9 bar Gauge, Isolated.....	GI0100
0 to 300 PSI/20.7 bar Gauge, Isolated.....	GI0300
0 to 500 PSI/34.5 bar Gauge, Isolated.....	GI0500
0 to 1,000 PSI/69 bar Gauge, Isolated.....	GI1000
0 to 3,000 PSI/206.8 bar Gauge, Isolated.....	GI3000
-14.7 PSIG/1 bar to +15 PSIG/1 bar Compound, Isolated .....	CI0015
-14.7 PSIG/1 bar to +30 PSIG/2 bar Compound, Isolated .....	CI0030
-14.7 PSIG/1 bar to +50 PSIG/3.4 bar Compound, Isolated .....	CI0050
-14.7 PSIG/1 bar to +100 PSIG/6.9 bar Compound, Isolated .....	CI0100
-14.7 PSIG/1 bar to +300 PSIG/20.7 bar Compound, Isolated .....	CI0300
-14.7 PSIG/1 bar to +500 PSIG/34.5 bar Compound, Isolated .....	CI0500
-14.7 PSIG/1 bar to +1,000 PSIG/69 bar Compound, Isolated .....	CI1000
-14.7 PSIG/1 bar to +3,000 PSIG/ 206.8 bar Compound, Isolated .....	CI3000
0-17 PSIA/1.2 bar Absolute, Isolated.....	AI0017
0-38 PSIA/2.6 bar Absolute, Isolated.....	AI0038
0-100 PSIA/6.9 bar Absolute, Isolated.....	AI0100
0-1,000 PSIA/69 bar Absolute, Isolated.....	AI1000

### Pressure Module Media Compatibility

Non-isolated DN sensors: clean, dry,  
non-corrosive, non-condensing gases only

Isolated DI sensors: any media  
compatible with 316L SS & Viton®

Isolated GI, CI & AI sensors: any media  
compatible with 316L SS

## Measure Pressure

- **Easily measure pressure with a plug in pressure module**

Purchase any of the pressure modules from the table below along with one of the three hand pumps and tubing kits for a complete pressure calibration system.

Sensor Code	Application	Ranges Available
DNxxxx	Differential, Non-isolated	0 to 0010*, 0028, 0200, 0415, 2000" H2O
DIxxxx	Differential, Isolated	0 to 0001, 0005, 0015, 0030, 0100, 0300, 0500 PSID
GIxxxx	Gauge, Isolated	0 to 0015, 0030, 0050, 0100, 0300, 0500, 1000, 3000 PSIG
CIxxxx	Compound, Isolated	-14.7 to +0015, 0030, 0050, 0100, 0300, 0500, 1000, 3000 PSIG
AIxxxx	Absolute, Isolated	0 to 0017, 0038, 0100, 1000 PSIA

### Media Compatibility

Non-isolated DN sensors: clean, dry, non-corrosive, non-condensing gases only

Isolated DI sensors: any media compatible with 316L SS & Viton®

Isolated GI, CI & AI sensors: any media compatible with 316L SS

### Accuracy

±0.025% of full scale including all effects of linearity, repeatability and hysteresis from -20° to +50°C (-4° to +122°F)

\* The DN0010 sensor accuracy is ±0.050% of full scale

### 32 Engineering Units:

PSI • inches, feet, mm, cm and meter of H2O @ 4°C, 20°C & 60°F • inches, meter, cm and mm of Hg @ 0°C;  
 torr • kg/cm2 • kg/m2 • Pa • hPa • kPa • MPa • Bar • mBar • ATM • oz/in2 • lb/ft2



**PIE 830 with Pressure Module, Pressure/Vacuum Pump & Hose**



## Hand Pumps, Tubing & Fitting Kits

- **Generate pressure with a full set of hand pumps**

Choose from a selection hand pumps, tubing & fittings made in the USA by Ralston Instruments. All pumps have two pressure ports - one port & hose go the PIE pressure module and the other to the pressure input of your instrument.

### Pneumatic Pressure/Vacuum Pump

0 to 125 psi & 0 to 23 inches vacuum



### Pneumatic Scissor Hand Pump

0 to 300 psi



### Hydraulic Scissor Hand Pump

0 to 3,000 psi



### Quick-test™ Hoses

Microbore hoses provide a very quick, low volume, high pressure way of connecting any pressure instrumentation to the hand pump and pressure module.



### Pressure Fitting Kit

Adapts from Quick-test™ hose to 1/4" male & female NPT, 1/8" male & female NPT and 1/4" tube fitting







**Hands free carrying case with pockets for the PIE 830 and the Pressure Module. Back of case has zippered pocket for the manual, test leads, hoses & pressure fittings.**



**Hands free carrying case with pockets for the PIE 830 and the Pressure Module.**

**Designed to be worn around your neck so that you can safely use both hands to calibrate.**

# PIE 830 Specifications

(Unless otherwise indicated all specifications are rated from a nominal 23°C, 70% RH for 1 year from calibration)

General	
Operating Temperature Range	-20 to 60 °C (-5 to 140 °F)
Storage Temperature Range	-30 to 60 °C (-22 to 140 °F)
Temperature effect	≤ ± 0.005 %/°C of Full Scale
Relative Humidity Range	10 % ≤RH ≤90 % (0 to 35 °C), Non-condensing 10 % ≤RH ≤ 70 % (35 to 60 °C), Non-condensing
Isolation: Voltage	60V rms between all milliamp functions/Read V DC and Source V DC/Thermocouple/RTD/Ohms/Frequency/Pressure
Common Mode	50/60 Hz, 100 dB
Normal Mode Rejection	50/60 Hz, 50 dB
Noise	≤ ± ½ Least Significant Digit from 0.1 to 10 Hz
Size	5.63 x 3.00 x 1.60 in, 143 x 76 x 41mm (L x W x H)
Weight	12.1 ounces, 0.34 kg (including boot & batteries)
Batteries	Four "AA" Alkaline 1.5V (LR6)
Optional NiMh Rechargeable battery kit	120 VAC for North America Only; charger, four NiMh batteries, AC & DC cords [Part # 020-0103]
Battery Life	Read Functions ≥ 20 hours; Read Pressure ≥ 7 hours Source mA ≥ 14 hours @ 12 mA into 250Ω Pwr/Meas mA ≥ 12 hours at 20 mA Source V, Ω, T/C, pH, RTD & Hz ≥ 20 hours
Low Battery	Low battery indication with nominal 1 hour of operation left
Protection against misconnection	Over-voltage protection to 60 vrms (rated for 30 seconds). Red LED indicates OVERLOAD or out of range conditions
Display	High contrast graphic liquid crystal display with 0.35" (9 mm) high digits on main & 0.2" (5 mm) on mA display. LED backlighting for use in low lit areas.

Read mA	
Ranges and Resolution	0.000 to 24.000 mA or -25.00 to 125.00% of 4-20 mA
Accuracy	≤ ± (0.02 % of Reading + 0.003 mA)
Voltage burden	≤ 2V at 24 mA
Overload/Current limit protection	25 mA nominal

Source mA / Power & Measure Two Wire Transmitters & PWRM LEAK	
Ranges and Resolution	0.000 to 24.000 mA or -25.00 to 125.00% of 4-20 mA
Accuracy	≤ ± (0.02 % of Reading + 0.003 mA)
Loop compliance voltage	≥ 24 DCV @ 20.00mA
Loop drive capability	1200 Ω at 20 mA for 15 hours nominal; 950 Ω with Hart Resistor or leak detection running

mA 2-Wire Transmitter Simulation	
Accuracy	Same as Source/Power & Measure
Voltage burden	≤ 2V at 20 mA
Overload/Current limit protection	24 mA nominal
Loop voltage limits	2 to 60 VDC (fuse-less protected from reverse polarity connections)

Voltage Read	
Range and Resolution	±99.999 mV, ±999.99mV, 0 to 10.250 V, 0.00 to 60.00 V DC
Accuracy	≤ ± (0.02 % of Reading + 0.01% Full Scale)
Input resistance	≥ 1 MΩ

Source V dc	
Ranges and Resolution	-20.000 to 99.999 mV, -500.00 to 999.99 mV, 0.000 to 10.250V
Accuracy	≤ ± (0.02 % of Reading + 0.01% Full Scale)
Source Current	≥ 20 mA
Sink Current	> 16 mA
Output Impedance	< 1 Ohm
Short Circuit Duration	Infinite

pH Source	
Accuracy in mV	≤ ± (0.02 % of Reading in mV + 0.1 mV)
Accuracy in pH	≤ ± 0.003 pH @ 25°C

Thermocouple Source	
Accuracy	≤ ± (0.02 % of Reading + 0.01 mV)
Cold Junction Compensation	± (0.1°C + 0.005%/°C)
Output Impedance	< 1 Ohm
Source Current	> 20 mA (drives 80 mV into 10 Ohms)

Thermocouple Read	
Accuracy & Cold Junction Compensation	Same as Thermocouple Source
Input Impedance	> 1 Megohms
Open TC Threshold; Pulse	10K Ohms; <5 μamp pulse for 300 milliseconds (nominal)

RTD, OHMS and Continuity Read	
Resistance Ranges	0.00 to 401.00, 0.0 to 4010.0 Ohms
Accuracy	±(0.025% of Reading + 0.075 Ohms)
Excitation Current	1.0 mA to 401 Ohms, 0.5 mA to 4010 Ohms (nominal)
Continuity	0.0 to 401.0 Ohms; Beeps from 0.0 to 100.0 Ohms

RTD and OHMS Source	
<b>3 Wire &amp; 4 Wire Accuracy</b> From 1 to 10.2 mA External Excitation Current	±(0.025% of Reading + 0.075 Ohms)
Below 1 mA of External Excitation Current	±(0.025% of Reading+0.075 Ohms + $\frac{0.025 \text{ mV}}{\text{mA Excitation Current}}$ )
<b>2 Wire Accuracy</b>	Add 0.1 Ohms to 3 Wire & 4 Wire Accuracy
Resistance Ranges	0.00 to 401.00 to 4010.0 Ohms
Allowable Excitation Current Range	400 Ohm Range: 10.2 mA max; steady or pulsed/intermittent 4000 Ohms Range: 1 mA max; steady or pulsed/intermittent
Pulsed Excitation Current Compatibility	DC to 0.01 second pulse width

Frequency Source	
Ranges	1 to 2000 CPM, 0.01 to 999.99 Hz, 0.1 to 9999.9 Hz, 0.001 to 20.000 kHz
Accuracy	±(0.02% of Reading + 0.01% of Full Scale)
Output V Waveform	Square Wave, Zero Crossing -1.0 to +5 V peak-to-peak ±10%
Risetime (10 to 90% of amplitude)	< 10 microseconds
Output Impedance	< 1 Ohm
Source Current	> 1 mA rms at 20 kHz
Short Circuit Duration	Infinite
Optical Coupling	Green LED (HZ SYNC) flashes at output frequency

Frequency Read	
Ranges & Accuracy	Same as Frequency Source
Accuracy	±(0.02% of Reading + 0.01% of Full Scale)
Trigger Level	1 V rms, dc coupled
Input Impedance	> 1 Meg Ohm + 60 pF

Specifications subject to change without notice.

## Thermocouple Ranges & Accuracies @ 23°C

T/C	Degrees C Range	°C	Degrees F Range	°F	T/C Material
<b>J</b>	-200.0 to -50.0	±0.5°	-328.0 to -58.0	±1.0°	+Iron -Constantan
	-50.0 to 300.0	±0.2°	-58.0 to 572.0	±0.4°	
	300.0 to 900.0	±0.3°	572.0 to 1652.0	±0.6°	
	900.0 to 1200.0	±0.4°	1652.0 to 2192.0	±0.8°	
<b>K</b>	-230.0 to -50.0	±1.2°	-382.0 to -58.0	±2.2°	+Chromel® -Alumel®
	-50.0 to 550.0	±0.3°	-58.0 to 1022.0	±0.6°	
	550.0 to 1000.0	±0.5°	1022.0 to 1832.0	±0.8°	
	1000.0 to 1371.1	±0.6°	1832.0 to 2500.0	±1.1°	
<b>T</b>	-260.0 to -230.0	±2.9°	-436.0 to -382.0	±5.2°	+Copper -Constantan
	-230.0 to -210.0	±1.0°	-382.0 to -346.0	±1.9°	
	-210.0 to -50.0	±0.8°	-346.0 to -58.0	±1.4°	
	-58.0 to 50.0	±0.3°	-58.0 to 122.0	±0.6°	
	50.0 to 400.0	±0.2°	122.0 to 752.0	±0.4°	
<b>E</b>	-240.0 to -200.0	±0.9°	-400.0 to -328.0	±1.7°	+Chromel -Constantan
	-200.0 to 0.0	±0.5°	-328.0 to 32.0	±0.8°	
	0.0 to 350.0	±0.2°	32.0 to 662.0	±0.3°	
	350.0 to 1000.0	±0.3°	662.0 to 1832.0	±0.6°	
<b>R</b>	-18.3 to 100.0	±2.1°	-1.0 to 212.0	±3.8°	+Pt/13Rh -Platinum
	100.0 to 500.0	±1.3°	212.0 to 932.0	±2.4°	
	500.0 to 1400.0	±1.0°	932.0 to 2552.0	±1.8°	
	1400.0 to 1767.8	±1.2°	2552.0 to 3214.0	±2.0°	
<b>S</b>	-18.3 to 100.0	±2.0°	-1.0 to 212.0	±3.7°	+Pt/10Rh -Platinum
	100.0 to 350.0	±1.4°	212.0 to 662.0	±2.5°	
	350.0 to 1600.0	±1.1°	662.0 to 2912.0	±2.0°	
	1600.0 to 1767.8	±1.3°	2912.0 to 3214.0	±2.4°	
<b>B</b>	315.6 to 600.0	±3.2°	600.0 to 1122.0	±5.7°	+Pt/30Rh -Pt/6Rh
	600.0 to 850.0	±1.7°	1122.0 to 1562.0	±3.1°	
	850.0 to 1100.0	±1.3°	1562.0 to 2012.0	±2.4°	
	1100.0 to 1820.0	±1.1°	2012.0 to 3308.0	±2.0°	

T/C	Degrees C Range	°C	Degrees F Range	°F	T/C Material
<b>N</b>	-230.0 to -150.0	±1.9°	-382.0 to -238.0	±3.4°	+Nicrosil -Nisil
	-150.0 to -50.0	±0.7°	-238.0 to -58.0	±1.2°	
	-50.0 to 950.0	±0.4°	-58.0 to 1742.0	±0.8°	
	950.0 to 1300.0	±0.5°	1742.0 to 2372.0	±1.0°	
<b>G (W)</b>	100.0 to 350.0	±1.7°	212.0 to 662.0	±3.0°	+Tungsten -W26/Re
	350.0 to 1700.0	±0.8°	662.0 to 3092.0	±1.5°	
	1700.0 to 2000.0	±1.0°	3092.0 to 3632.0	±1.8°	
	2000.0 to 2320.0	±1.1°	3632.0 to 4208.0	±2.1°	
<b>C (W5)</b>	-1.1 to 100.0	±0.8°	30.1 to 212.0	±1.4°	+W5/Re -W26/Re
	100.0 to 1000.0	±0.7°	212.0 to 1832.0	±1.3°	
	1000.0 to 1750.0	±1.2°	1832.0 to 3182.0	±2.1°	
	1750.0 to 2320.0	±2.0°	3182.0 to 4208.0	±3.5°	
<b>D</b>	-1.1 to 150.0	±1.0°	30.1 to 302.0	±1.8°	+W3/Re -W25/Re
	150.0 to 1100.0	±0.7°	302.0 to 2012.0	±1.3°	
	1100.0 to 1750.0	±1.0°	2012.0 to 3182.0	±1.8°	
	1750.0 to 2320.0	±2.0°	3182.0 to 4208.0	±3.6°	
<b>P</b>	0.0 to 600.0	±0.3°	32.0 to 1112.0	±0.6°	+Pd55/Pt31/ Au14 -Au65/Pd35
	600.0 to 900.0	±0.4°	1112.0 to 1652.0	±0.8°	
	900.0 to 1200.0	±0.6°	1652.0 to 2192.0	±1.1°	
	1200.0 to 1395.0	±0.7°	2192.0 to 2543.0	±1.2°	
<b>L J-DIN</b>	-200.0 to -50.0	±0.4°	-328.0 to -58.0	±0.7°	+Iron -Constantan
	-50.0 to 300.0	±0.2°	-58.0 to 572.0	±0.4°	
	300.0 to 900.0	±0.3°	572.0 to 1652.0	±0.5°	
<b>U T-DIN</b>	-200.0 to -50.0	±0.6°	-328.0 to -58.0	±1.1°	+Copper -Constantan
	-50.0 to 50.0	±0.3°	-58.0 to 122.0	±0.5°	
	50.0 to 550.0	±0.2°	122.0 to 1022.0	±0.4°	
	550.0 to 600.0	±0.3°	1022.0 to 1112.0	±0.5°	

Table based on Thermocouple Accuracy  $\leq \pm (0.02\% \text{ of Reading in mV} + 0.01 \text{ mV})$   
 Note: Doesn't include cold junction error of  $\pm 0.05^\circ\text{C}$

## RTD Ranges & Accuracies

RTD Type	Alpha	Degrees C Range	°C	Degrees F Range	°F
Pt 100 Ohm DIN/IEC/JIS 1989 Based on ITS-90	1.3850 (0.00385)	-200.0 to 0.0	±0.2°	-328.0 to 32.0	±0.4°
		0.0 to 340.0	±0.3°	248.0 to 644.0	±0.6°
		340.0 to 640.0	±0.4°	644.0 to 1184.0	±0.8°
		640.0 to 850.0	±0.5°	1184.0 to 1562.0	±1.0°
Pt 100 Ohm (Burns)	1.3902 (0.003902)	-200.0 to 10.0	±0.2°	-328.0 to 50.0	±0.4°
		10.0 to 350.0	±0.3°	50.0 to 662.0	±0.6°
		350.0 to 650.0	±0.4°	662.0 to 1202.0	±0.8°
		650.0 to 850.0	±0.5°	1202.0 to 1562.0	±0.9°
Pt 100 Ohm (Old JIS 1981)	1.3916 (0.003916)	-200.0 to 20.0	±0.2°	-328.0 to 68.0	±0.4°
		20.0 to 360.0	±0.3°	68.0 to 680.0	±0.6°
		360.0 to 650.0	±0.4°	680.0 to 1202.0	±0.8°
		650.0 to 850.0	±0.5°	1202.0 to 1562.0	±0.9°
Pt 100 Ohm (US Lab)	1.3926 (0.003926)	-200.0 to 20.0	±0.2°	-328.0 to 68.0	±0.4°
		20.0 to 360.0	±0.3°	68.0 to 680.0	±0.6°
		360.0 to 660.0	±0.4°	680.0 to 1220.0	±0.8°
		660.0 to 850.0	±0.5°	1220.0 to 1562.0	±0.9°

RTD Type	Alpha	Degrees C Range	°C	Degrees F Range	°F
Pt 1000 Ohm DIN/IEC/JIS 1989	1.3850 (0.00385)	-200.0 to 0.0	±0.2°	-328.0 to 32.0	±0.4°
		0.0 to 340.0	±0.3°	248.0 to 644.0	±0.6°
		340.0 to 640.0	±0.4°	644.0 to 1184.0	±0.8°
		640.0 to 850.0	±0.5°	1184.0 to 1562.0	±1.0°
Copper 10 Ohm (Minco)	1.4274 (0.004274)	-200.0 to 260.0	±2.0°	-328.0 to 500.0	±3.6°
Copper 50 Ohm	1.4280 (0.00428)	-50.0 to 150.0	±0.4°	-58.0 to 302.0	±0.8°
Ni 120 Ohm (Pure)	1.6720 (0.00672)	-80.0 to 260.0	±0.1°	-112.0 to 500.0	±0.3°
Ni 110 (Bristol 7 NA)	1.5801 (0.005801)	-100.0 to 260.0	±0.2°	-148.0 to 500.0	±0.4°

Table based on 3 & 4 Wire RTD Accuracy:  $\leq \pm (0.025\% \text{ of Reading} + 0.075 \text{ Ohms})$

## Standard Warranty

Our equipment is warranted against defective material and workmanship (excluding batteries) for a period of three years from the date of shipment. Claims under warranty can be made by returning the equipment prepaid to our factory. The equipment will be repaired, replaced or adjusted at our option. The liability of Practical Instrument Electronics (PIE) is restricted to that given under our warranty. No responsibility is accepted for damage, loss or other expense incurred through sale or use of our equipment. Under no condition shall Practical Instrument Electronics, Inc. be liable for any special, incidental or consequential damage.

Pressure sensors that have been damaged by over pressurization or contaminated by process chemicals are not covered by our warranty. Pneumatic pumps that are contaminated with process chemicals are also not covered by our warranty.

## Optional Repair/Replacement Warranty

Under our Repair/Replacement Warranty (RP-WAR-B), our equipment is warranted against ANY damage or malfunction that may cause the unit to fail for a period of three (3) years from the date of shipment.

This warranty is limited to one complete replacement against any damage or malfunction during the warranty period. If replaced, the new calibrator will carry our Standard Warranty for the remainder of the three (3) years or a minimum of one (1) year from the date of shipment.

## Additional Information

PIE Calibrators are manufactured in the USA. This product is calibrated on equipment traceable to NIST and *includes* a Certificate of Calibration. Test Data is available for an additional charge.

Practical Instrument Electronics recommends a calibration interval of one year. Contact your local representative for recalibration and repair services.



**Flip out stand for bench use**



## Available From:

Contact:  
Industrial Process Measurement, Inc.  
3910 Park Avenue, Unit 7  
Edison, NJ 08820  
732-632-6400  
support@instrumentation2000.com  
<http://www.instrumentation2000.com>