

# PIECAL 820

## Multifunction Process Calibrator

mA • V • TC •  $\Omega$  • RTD • Hz

## Operating Instructions



CE



Practical Instrument Electronics

82 East Main Street Suite 3.14 • Webster, NY 14580 USA

Tel: 585.872.9350 • Fax: 585.872.2638 • sales@piecal.com • www.piecal.com

# Contents

## General Operations

Field & Bench Use, Changing Batteries.....	2
Storing EZ-CHECK Outputs, Connections.....	3

## Basic Operation

Switches & Knobs .....	4, 5
Double Click Menus .....	6, 7
Stepping, Auto Off, Backlight.....	8, 9

## Functions and Hookup Diagrams

Milliamp	
Source mA.....	10
Simulate 2 Wire Transmitters .....	11
Read mA .....	12
Power/Measure Transmitters .....	13
Voltage & Millivolt	
Source mV/V .....	14
Read mV/V .....	15
Thermocouple	
Source T/C .....	16
Read T/C Sensors.....	17
Resistance	
Source Resistance .....	18
Read Resistance & Check Continuity .....	19
RTD	
Source RTD.....	20
Read RTD Sensors .....	21
Frequency	
Source Frequency .....	22
Read Frequency .....	23

## Specifications

General.....	24-28
Thermocouple Ranges & Accuracies .....	29-31
RTD Ranges & Accuracies.....	32

## Additional Information

Warranty & Accessories .....	33
------------------------------	----

## General Information

### **Technician friendly operation**

The unique and intuitive *EZ-DIAL Double Click Menu* makes it easier to setup than other multifunction calibrators. Uses the same menus as the single function PIECAL Evolution Calibrators. Icons on the display indicate where to plug in the test leads.

### **Use it as a milliamp and voltage calibrator**

Source 0 to 24.00 mA, 0 to 10.25 V & -10.00 to 80.00 mV dc  
Read 0 to 24.00 mA, 0 to 10.25 V, 0 to 60.0 V and -10.00 to 80.00 mV dc

Simulate 2-Wire Transmitters & Power up transmitters & loops

### **Calibrate in temperature with 0.1°C/°F resolution**

Types J, K, T, E, R, S, B, N, G, C, D, L (J DIN), U (T DIN) & P II  
Pt 100 Ohm (3850, 3902, 3916, 3926) & 1000 Ohm (3850) RTD  
Copper 10 & 50 Ohm, Nickel 100 and 120 Ohm RTD

### **Checkout flow and vibration systems**

Source & read frequency from 0 to 2000 CPM (Counts-Per-Minute), 0.00 to 999.99 Hz, 0.0 to 9999.9 Hz and 0.000 to 20.000 kHz.

### **Checkout resistance instruments, loop & wiring problems**

Source and read resistance from 0.0 to 401.0 and 0 to 4010 ohms. 'Beep' out connections with the built-in continuity checker.

### **Guaranteed compatible with all instrumentation**

Works with Rosemount & Honeywell Smart Transmitters, PLCs, DCSs, Multi-Channel Recorders and other pulsed excitation devices.

### **Easy to read**

Turn on the backlight & easily see the display in dark areas.

### **Quickly set any three outputs plus automatic stepping & ramping**

Easily set any value quickly with the adjustable "DIAL" plus store any three output settings for instant recall with the EZ-CHECK™ switch. Choose between 2, 3, 5 & 11 steps or RAMP to increase and decrease the output between Zero and Span from 5, 6, 7, 8, 9, 10, 15, 20, 25, 30 and 60 seconds.

### **Measure temperature sensors, frequency pickups, mA & V**

Check the values of your process sensors. Instantly recall MAX and MIN values to see process variability.

# Operating Instructions

## FIELD & BENCH USE

PIECAL 820 comes with a carrying case designed for hands-free operation and a rubber boot with a built-in tilt stand. The PIECAL 820 is held in the case by elastic straps for use with the carrying case open. The tilt stand is easily raised by pulling the stand until it locks into place.



## CHANGING BATTERIES

Low battery is indicated by a battery symbol on the display. Approximately one to four hours of typical operation remain before the PIECAL 820 will automatically turn off. To change the batteries; remove the rubber boot, remove the battery door from the back of the unit by sliding the door downward. This allows access to the battery compartment. Replace with four (4) "AA" 1.5V batteries being careful to check the polarity. Replace the battery door and replace the boot. All stored configuration options (T/C Type, EZ-CHECK Memories, etc.) are reset to factory settings when the batteries are removed.

**Note:** Alkaline batteries are supplied and recommended for typical battery life and performance. Optional rechargeable batteries (charged externally) are available.

# Operating Instructions

## STORING HI and LO EZ-CHECK Source Outputs

Speed up your calibration by storing Span & Zero output setting for instant recall with the EZ-CHECK switch.

- 1) Store your high (SPAN) output temperature by moving the EZ-CHECK switch to the **HI** position and turning the EZ-Dial knob until the desired output value is on the display. Press and hold the EZ-Dial knob until **STORED** appears to store the value. Release the EZ-Dial knob.
- 2) Store your low (ZERO) output value by moving the EZ-CHECK switch to the **LO** position and turning the EZ-Dial knob until the desired output value is on the display. Press and hold the EZ-Dial knob until **STORED** appears to store the value. Release the EZ-Dial knob.
- 3) Instantly output your SPAN and ZERO output settings by moving the EZ-CHECK switch between HI and LO. You may also select any third output setting (such as mid-range) using the SET position on the EZ-CHECK switch.

## Connections

PIECAL 820 has banana jacks compatible with standard banana plugs or retractable safety banana plugs. Included with your calibrator are a pair of test leads with alligator clips for mA, V & Hz connections. Four test leads with spade lugs are also included for 2, 3 and 4 Wire RTD connections. Thermocouple connections are made through a miniature thermocouple socket.

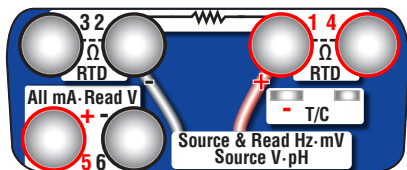

# Operating Instructions

## Basic Operation



### ① EZ-CHECK™ SWITCH

**SOURCE:** Instantly output two preset settings by moving the EZ-CHECK™ switch to the “LO” position or “HI” position. For fast three point checks select the “SET” position. The PIECAL 820 will remember the last “SET” value, even with the power off. These values can easily be changed to suit the calibration requirements. The values stored in the HI and LO positions are also used for Auto Stepping.

**READ:** Slide the switch to the SET position. The PIECAL 820 will display the current reading from the sensor or device being measured. Slide the switch to MAX and the highest value measured since turn-on or MAX/MIN reset will be displayed; slide the switch to MIN and the lowest value measured since turn-on or MAX/MIN reset will be displayed.

# Operating Instructions

## Basic Operation

### ② SOURCE/OFF/READ Switch

Select “**SOURCE**” to output mA, V, T/C,  $\Omega$ , RTD or Hz.

Select “**READ**” to read mA, V, T/C,  $\Omega$ , RTD or Hz.

### ③ EZ-DIAL™ KNOB

**SOURCE:** Turn the knob to adjust the output level. Turn clockwise to increase the output, counter clockwise to decrease the output in one least significant digit steps at a time. Push down and turn the EZ-DIAL knob for faster dialing.

Press and hold the knob for two seconds to store desired EZ-Check™ HI/LO points in SOURCE mode. Continue to press and hold the knob for two more seconds to start the automatic ramping.

**READ:** Press and hold to transfer the current temperature into the EZ-Check™ MIN/MAX points. This clears the MIN/MAX readings which will update as the input value changes.

## SELECTING FUNCTIONS

The EZ-DIAL knob is used to setup the PIECAL 820 to match the instrument to be calibrated or signal to be measured. Each time you turn on the PIECAL 820 the LCD displays the following screen for about 1 second followed by operating in the function used the last time it was operated.

**MODEL 820  
DOUBLE CLICK  
EZ-DIAL KNOB  
FOR CONFIGURATION  
V #.##**

Double Click the EZ-DIAL knob to change the function of the calibrator and to select ranges, units and other user settings. Each function (mA, V, T/C, Ohms, RTD, Frequency) has two pages of menus. The first menu page has settings for the function and the second menu page has settings for STEPPING, AUTO OFF and BACKLIGHT. Settings are remembered even with the power off but are reset when the batteries are changed.

# Operating Instructions

## Double Click Menus

Double click the EZ-DIAL knob to access the Double Click Menus to select each function and the options for each function. Available choices are shown in grey.

### Source mA & Simulate 2 Wire Transmitters

	<b>MAIN</b>	
> EXIT	(1/2)	
FUNCTION		mA
MODE		SOURCE 2W SIM
UNITS		mA %
HART 250Ω		ON OFF

### Read mA & Power/Measure Transmitters

> EXIT	(1/2)	
FUNCTION		mA
MODE		READ PWR MEAS
UNITS		mA %
HART 250Ω		ON OFF

### Source Volts & Millivolts

> EXIT	(1/2)	
FUNCTION		V
RANGE		10V 80mV

### Read Volts & Millivolts

> EXIT	(1/2)	
FUNCTION		V
RANGE		10V 60V 80mV

### Source & Read Frequency

> EXIT	(1/2)	
FUNCTION		FREQ
RANGE		20KHZ 10000HZ 1000HZ 2000CPM



# Operating Instructions

## Double Click Menus

### Source & Read Thermocouples

> EXIT (1/2)  
FUNCTION T/C  
UNITS °C °F  
T/C TYPE J K E T R S B N L U G C D P  
COLD JUNC ON

### Source RTD

> EXIT (1/2)  
FUNCTION RTD  
UNITS °C °F  
RTD Pt 100  $\alpha=3850$  [\* RTD Types]  
WIRE MODE 234W

### Read RTD

> EXIT (1/2)  
FUNCTION RTD  
UNITS °C °F  
RTD Pt 100  $\alpha=3850$  [\* RTD Types]  
WIRE MODE 3W 2W 4W

\* RTD Types: Pt 100  $\alpha=3850$ ,  $\alpha=3902$ ,  $\alpha=3916$ ,  $\alpha=3926$   
Pt 1000  $\alpha=3850$ ; Cu 10  $\alpha=4274$ , Cu 50  $\alpha=4280$   
Ni 120  $\alpha=6720$ , Ni 110  $\alpha=5801$

### Source Ohms

>EXIT (1/2)  
FUNCTION OHMS  
RANGE 400 $\Omega$  4000 $\Omega$   
WIRE MODE 234W

### Read Ohms

>EXIT (1/2)  
FUNCTION OHMS  
RANGE 400 $\Omega$  4000 $\Omega$  CONT  
WIRE MODE 3W 2W 4W

## Operating Instructions

### Double Click Menu - STEPPING, AUTO OFF & BACKLIGHT

#### To change the Automatic Stepping settings

Double click the ③ DIAL KNOB at any time the unit is on and the following typical display (will be different for each FUNCTION) will appear for 15 seconds:

MAIN	
> EXIT	(1/2)
FUNCTION	mA
MODE	SOURCE
UNITS	mA
HART	250Ω ON

Turn the ③ DIAL KNOB to move to the second menu (FEATURES) page.

Turn the ③ DIAL KNOB to move through the menu. Press the ③ DIAL KNOB to toggle between OFF and ON or to change the STEPS/RAMP and the STEP/RAMP TIME settings. These settings are remembered even with the power off.

FEATURES	
> EXIT	(2/2)
AUTO OFF	ON
BACKLIGHT	ON
STEPS/RAMP	3
STEP/RAMP TIME	5

**EXIT MENU** - exits this menu immediately and saves any changes. Menu will automatically exit after 15 seconds of inactivity.

---

**AUTO OFF** - If AUTO OFF is ON, the unit will turn off after 30 minutes of inactivity to save battery life. If AUTO OFF is OFF the unit will stay on until the POWER SWITCH is moved to the off position.

## Operating Instructions

### Double Click Menu - STEPPING, AUTO OFF & BACKLIGHT

**STEPS/RAMP** - pressing the knob will cycle through 2, 3, 5, 11 and RAMP. The endpoints of the steps or ramp are based on the values stored in the **HI** and **LO** EZ-CHECK outputs.

**2 steps** will automatically switch between the values stored in the HI & LO EZ-CHECK (0 & 100%).

**3 steps** between the HI, Midpoint and LO EZ-CHECK (0, 50 & 100%).

**5 steps** between the HI and LO EZ-CHECK in 25% increments (0, 25, 50, 75 & 100%).

**11 steps** between the HI and LO EZ-CHECK in 10% increments (0, 10, 20...80, 90 & 100%).

**RAMP** continuously ramps up and down between the HI and LO EZ-CHECK outputs.

**STEP/RAMP TIME** - pressing the knob will cycle through 5, 6, 7, 8, 9, 10, 15, 20, 25, 30 and 60 seconds.

### **To start the Automatic Stepping**

Start automatic stepping or ramping by placing the EZ-CHECK Switch into the HI or LO position then press and hold the ③ DIAL KNOB for 6 seconds (the word STORE will appear on the display after 3 seconds and continue to press the EZ-DIAL KNOB) until the word STEP appears on the display. The word STEP will appear on the display anytime the selected automatic function is running. Stop the stepping or ramping by again pressing and holding the ③ DIAL KNOB for 3 seconds.

---

**BACKLIGHT** - If BACKLIGHT is ON the backlight will light all the time the unit is powered up. For maximum battery life turn the backlight off when using the calibrator in areas with enough ambient light to read the display.

## SOURCE mA / SOURCE % (Percent of 4 to 20 mA)

Choose this function to provide an output from 0.00 to 24.00 milliamps. The compliance voltage is a nominal 24 VDC to provide the driving power to your milliamp receivers.

Move the power switch ② to SOURCE then Double Click the EZ-DIAL knob to get into the Double Click Menu. Turn the knob to scroll through the settings and press the knob to make your selection. Select mA for the FUNCTION and SOURCE for the MODE. Choose either mA or % and whether you need the 250Ω HART resistor active in the loop.

Connect the output leads of the PIECAL 820 to the inputs of the device being calibrated, making sure to check polarity. Red lead to the plus (+) input and black lead to the minus (-) input. Open loops and signals above the maximum scale are limited by protection circuitry with "ERROR" or "OVER RANGE" flashed on the display and the red OVERLOAD LED lit.

Instantly output your SPAN and ZERO output settings by moving the EZ-CHECK switch between HI and LO (defaults to 20 & 4 mA). You may also select any third output setting (such as mid-range) using the SET position on the EZ-CHECK switch. The output is adjusted in 0.01 mA (0.1%) increments by turning the knob ③. Press and turn the knob for faster dialing with 1.00 mA (10.0%) increments.

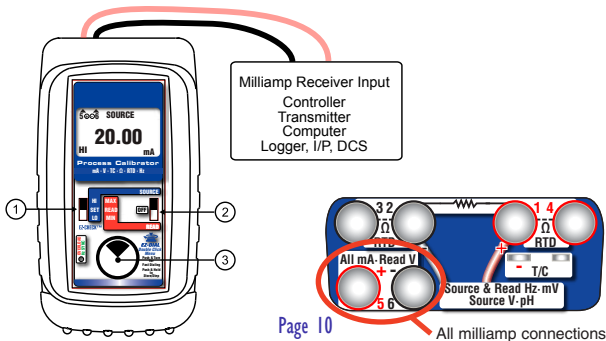

## 2 Wire SIM mA, 2 Wire SIM % (Percent of 4 to 20 mA)

Choose this function to simulate a 2 Wire Transmitter output from 0.00 to 24.00 milliamps. Operates in loops with power supply voltages from 2 to 60 VDC.

Move the power switch ② to SOURCE then Double Click the EZ-DIAL knob to get into the Double Click Menu. Turn the knob to scroll through the settings and press the knob to make your selection. Select mA for the FUNCTION and 2W SIM for the MODE. Choose either mA or % and whether you need the 250Ω HART resistor active in the loop.

Connect the output leads of the PIECAL 820 to the inputs of the device being calibrated, making sure to check polarity. Red lead to the plus (+) input and black lead to the minus (-) input. Open loops and signals above the maximum scale are limited by protection circuitry with “ERROR” or “OVER RANGE” flashed on the display and the red OVERLOAD LED lit.

Instantly output your SPAN and ZERO output settings by moving the EZ-CHECK switch between HI and LO (defaults to 20 & 4 mA). You may also select any third output setting (such as mid-range) using the SET position on the EZ-CHECK switch. The output is adjusted in 0.01 mA (0.1%) increments by turning the knob ③. Press and turn the knob for faster dialing with 1.00 mA (10.0%) increments.

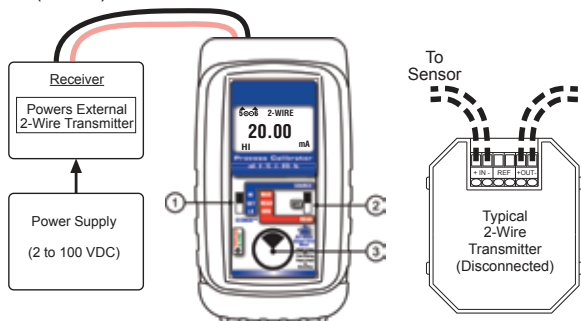

## READ mA, READ % (Percent of 4 to 20 mA)

Choose this function to measure from 0.00 to 24.00 milliamps or -25.0 to 125.0%.

Move the power switch ② to READ then Double Click the EZ-DIAL knob to get into the Double Click Menu. Turn the knob ③ to scroll through the settings and press the knob to make your selection. Select mA for the FUNCTION and READ for the MODE. Choose either mA or % and whether you need the 250Ω HART resistor active in the loop.

Connect the red input lead (+) of the PIECAL 820 to the more positive point of the break and the black input to the more negative point.

Signals below 0 mA or open circuits are indicated by 0.00 mA (-25.0%) on the display. Signals above 24 mA are current limited by protection circuitry with "OVER RANGE" on the display and the red OVERLOAD LED lit.

The PIECAL 820 measures the input signal and constantly updates the display with the current reading. Move the EZ-CHECK switch ① to MAX to see the highest reading and to MIN to see the lowest reading. Press and hold the knob ③ to clear the MAX and MIN readings.

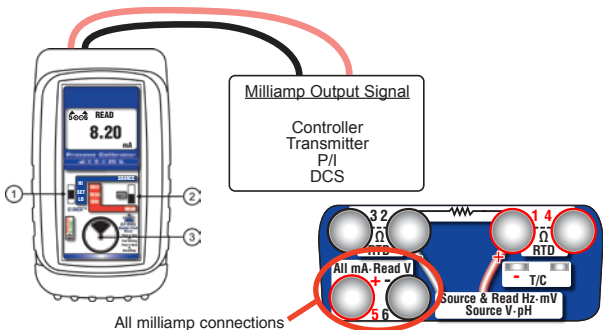

## Power/Measure mA, Power/Measure % (Percent of 4 to 20 mA)

Choose this function to simultaneously supply power to a 2 Wire Transmitter while displaying the 4 to 20 mA output of the transmitter.

Move the power switch ② to READ then Double Click the EZ-DIAL knob to get into the Double Click Menu. Turn the knob ③ to scroll through the settings and press the knob to make your selection. Select mA for the FUNCTION and PWR MEAS for the MODE. Choose either mA or % and whether you need the 250Ω HART resistor active in the loop.

Disconnect one or both input wires from the device to be calibrated. Connect the red source lead of the PIECAL 820 to the plus (+) input of the device and the black source lead to the minus (-).

The PIECAL 820 supplies a nominal 24 volts DC at 24 mA to the 2 Wire Transmitter. The current passed by the transmitter will be accurately displayed by the PIECAL 820. Calibrate the transmitter in the usual manner and disconnect the PIECAL 820. Signals above 24 mA are current limited by protection circuitry with "OVER RANGE" on the display and the red OVERLOAD LED lit.

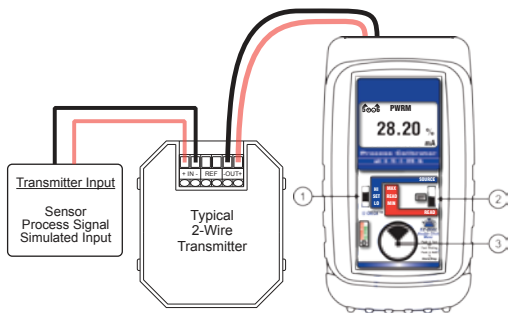

## SOURCE mV / V

Choose this function to provide an output from 0.00 to 80.00 mV or from 0.00 to 10.25 V. The source current is a nominal 24 mA to provide the driving power to your voltage receivers.

Move the power switch ② to SOURCE then Double Click the EZ-DIAL knob to get into the Double Click Menu. Turn the knob to scroll through the settings and press the knob to make your selection. Select V for the FUNCTION and 10V or 80 mV for the RANGE.

Connect the output leads of the PIECAL 820 to the inputs of the device being calibrated, making sure to check polarity. Red lead to the plus (+) input and black lead to the minus (-) input.

Instantly output your SPAN and ZERO output settings by moving the EZ-CHECK switch between HI and LO. You may also select any third output setting (such as mid-range) using the SET position on the EZ-CHECK switch. The output is adjusted in 0.01 mV or V increments by turning the knob ③. Press and turn the knob for faster dialing with 1.00 mV or V increments.

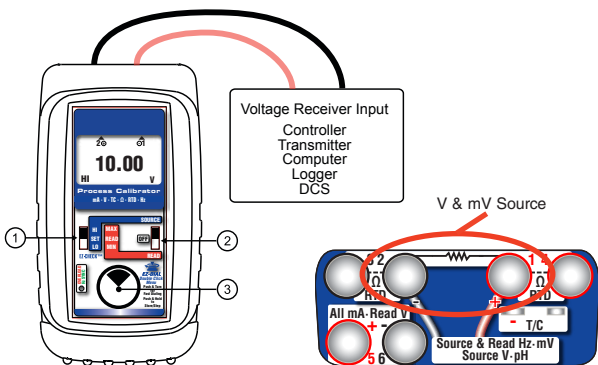



## Read mV / V

Choose this function to measure from 0.00 to 80.00 millivolts, 0.00 to 10.25 V dc or 0.0 to 60.0 V dc.

Move the power switch ② to READ then Double Click the EZ-DIAL knob to get into the Double Click Menu. Turn the knob to scroll through the settings and press the knob to make your selection. Select V for the FUNCTION and 10V, 60V or 80 mV for the RANGE.

Connect the red input lead (+) of the PIECAL 820 to the more positive point of the break and the black input to the more negative point.

Signals above the maximum scale are limited by protection circuitry with "OVER RANGE" on the display and the red OVERLOAD LED lit.

The PIECAL 820 measures the input signal and constantly updates the display with the current reading. Move the EZ-CHECK switch ① to MAX to see the highest reading and to MIN to see the lowest reading. Press and hold the knob ③ to clear the MAX and MIN readings.

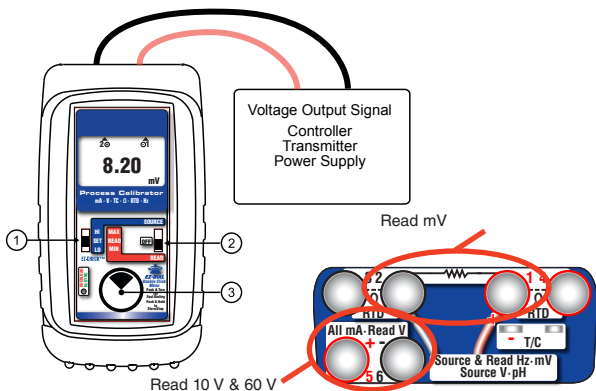

## Source Thermocouple

Choose this function to provide a simulated thermocouple signal into controllers, temperature transmitters, indicators or any input devices that measure thermocouple sensors.

Move the power switch ② to SOURCE then Double Click the EZ-DIAL knob to get into the Double Click Menu. Turn the knob to scroll through the settings and press the knob to make your selection. Select T/C for the FUNCTION, °F or °C for the UNITS, T/C Type (J, K, T, E, R, S, B, N, G, C, D, L (J-DIN), U (T-DIN) or P (Platinel II) and internal COLD JUNC ON or OFF (ON is the default).

Connect the PIECAL 820 to the inputs of the device being calibrated using the proper type of thermocouple wire via the miniature thermocouple socket.

Instantly output your SPAN and ZERO output settings by moving the EZ-CHECK switch between HI and LO. You may also select any third output setting (such as mid-range) using the SET position on the EZ-CHECK switch. The output is adjusted in 0.1° increments by turning the knob ③. Press and turn the knob for faster dialing with 10.0° increments.

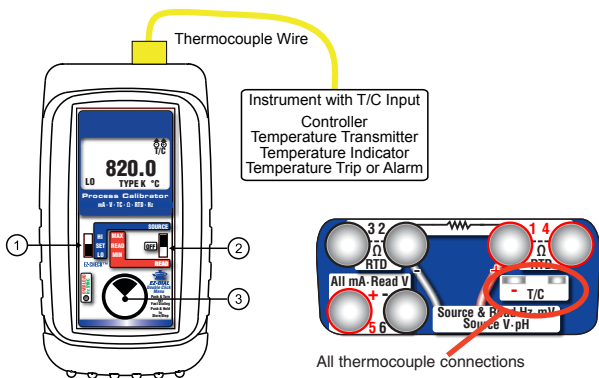

## Read Thermocouple Sensors

Choose this function to measure temperatures with a thermocouple probe or sensor.

Move the power switch ② to READ then Double Click the EZ-DIAL knob to get into the Double Click Menu. Turn the knob to scroll through the settings and press the knob to make your selection. Select T/C for the FUNCTION, °F or °C for the UNITS, T/C Type (J, K, T, E, R, S, B, N, G, C, D, L (J-DIN), U (T-DIN) or P (Platinel II) and COLD JUNC ON or OFF (ON is the default).

Connect the PIECAL 820 to the inputs of the device being calibrated using the proper type of thermocouple wire via the miniature thermocouple socket. If no sensor is connected, a wire is broken or the sensor is burned out, OPEN TC will appear on the display. Signals above the maximum scale are limited by protection circuitry with "OVER RANGE" on the display and the red OVERLOAD LED lit.

The PIECAL 820 measures the input signal and constantly updates the display with the current reading. Move the EZ-CHECK switch ① to MAX to see the highest reading and to MIN to see the lowest reading. Press and hold the knob ③ to clear the MAX and MIN readings.

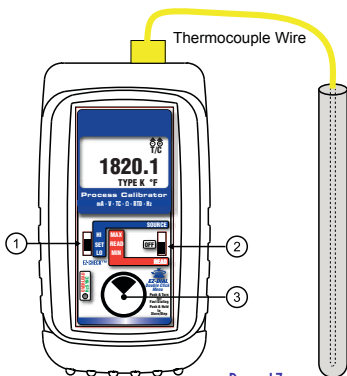

## Source Resistance

Choose this function to provide a simulated resistance into any device that measures resistance.

Move the power switch ② to SOURCE then Double Click the EZ-DIAL knob to get into the Double Click Menu. Turn the knob to scroll through the settings and press the knob to make your selection. Select OHMS for the FUNCTION, 400 $\Omega$  or 4000 $\Omega$  for the RANGE.

Disconnect all sensor wires from the devices to be calibrated and connect the PIECAL 820 to the inputs of the device using 2, 3 or 4 wires.

Instantly output your SPAN and ZERO output settings by moving the EZ-CHECK switch between HI and LO. You may also select any third output setting (such as mid-range) using the SET position on the EZ-CHECK switch. The output is adjusted in 0.1 $\Omega$ /1 $\Omega$  increments by turning the knob ③. Press and turn the knob for faster dialing with 10.0 $\Omega$ /100 $\Omega$  increments.

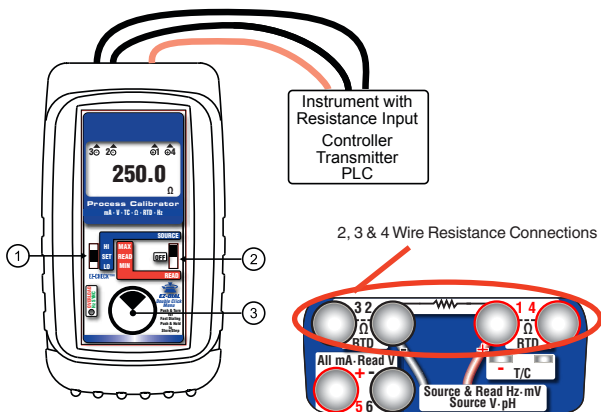

## Read Resistance & Check Continuity

Choose this function to measure resistance or check continuity.

Move the power switch ② to READ then Double Click the EZ-DIAL knob to get into the Double Click Menu. Turn the knob to scroll through the settings and press the knob to make your selection. Select OHMS for the FUNCTION, 400Ω, 4000Ω or Continuity for the RANGE. You must also select the WIRE MODE for 2W, 3W or 4W to match the 2, 3 or 4 wires being used to measure resistance. For continuity the only choice is 2W.

Disconnect all wires from the sensor and connect the PIECAL 820 to the inputs of the device using 2, 3 or 4 wires.

If continuity is selected, resistance is measured up to 400.0Ω. The beeper will sound and ))) appears on the display when resistances below 100.0Ω are measured.

Signals above the maximum scale are limited by protection circuitry with "OVER RANGE" on the display and the red OVERLOAD LED lit.

The PIECAL 820 measures the input signal and constantly updates the display with the current reading. Move the EZ-CHECK switch ① to MAX to see the highest reading and to MIN to see the lowest reading. Press and hold the knob ③ to clear the MAX and MIN readings.

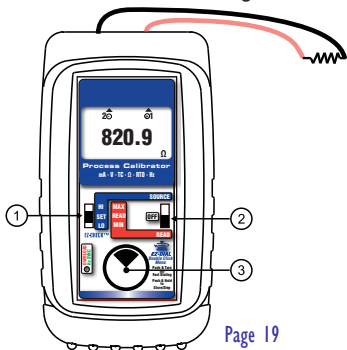

## Source RTD

Choose this function to provide a simulated RTD signal into controllers, temperature transmitters, indicators or any input devices that measure RTD sensors.

Move the power switch ② to SOURCE then Double Click the EZ-DIAL knob to get into the Double Click Menu. Turn the knob to scroll through the settings and press the knob to make your selection. Select RTD for the FUNCTION, °F or °C for the UNITS and RTD (Choose from one of Platinum 100Ω, or 1000Ω, Copper 10Ω or 50Ω, Nickel 120Ω or 110Ω curves). *Note: Pt 100Ω 3850 is the most common RTD type.*

Disconnect all sensor wires from the devices to be calibrated and connect the PIECAL 820 to the inputs of the device using 2, 3 or 4 wires.

Instantly output your SPAN and ZERO output settings by moving the EZ-CHECK switch between HI and LO. You may also select any third output setting (such as mid-range) using the SET position on the EZ-CHECK switch. The output is adjusted in 0.1° increments by turning the knob ③. Press and turn the knob for faster dialing with 10.0° increments.

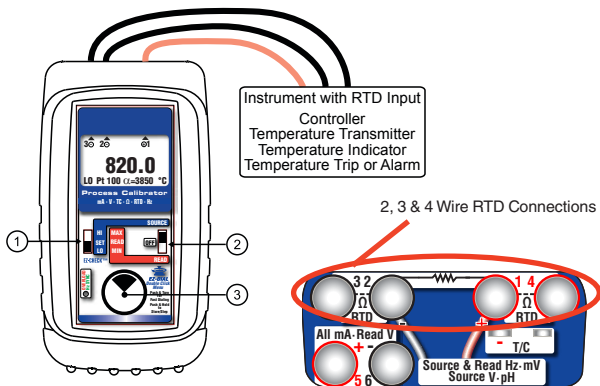

## Read RTD Sensors

Choose this function to measure temperatures with an RTD probe or sensor.

Move the power switch ② to READ then Double Click the EZ-DIAL knob to get into the Double Click Menu. Turn the knob to scroll through the settings and press the knob to make your selection. Select RTD for the FUNCTION, °F or °C for the UNITS and RTD (Choose from one of Platinum 100Ω, or 1000Ω, Copper 10Ω or 50Ω, Nickel 120Ω or 110Ω curves). *Note: Pt 100Ω 3850 is the most common RTD type.* You must also select the WIRE MODE for 2W, 3W or 4W to match the 2, 3 or 4 wires on the RTD sensor.

Disconnect all wires from the sensor and connect the PIECAL 820 to the inputs of the device using 2, 3 or 4 wires.

Signals above the maximum scale are limited by protection circuitry with "OVER RANGE" on the display and the red OVERLOAD LED lit.

The PIECAL 820 measures the input signal and constantly updates the display with the current reading. Move the EZ-CHECK switch ① to MAX to see the highest reading and to MIN to see the lowest reading. Press and hold the knob ③ to clear the MAX and MIN readings.

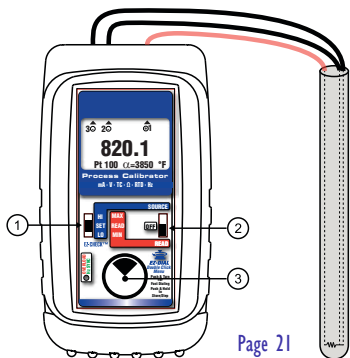

## Source Frequency

Choose this function to provide a frequency signal into any input devices that measure frequency.

Move the power switch ② to SOURCE then Double Click the EZ-DIAL knob to get into the Double Click Menu. Turn the knob to scroll through the settings and press the knob to make your selection. Select **FREQ** for the **FUNCTION** and **20KHZ**, **10000HZ**, **1000HZ** or **2000CPM** for the **RANGE**.

Disconnect all input wires from the devices to be calibrated and connect the PIECAL 820 to the input of the device matching polarity.

The green HZ SYNC LED pulses in synch with the output pulses and may be used to calibrate optical pickups. The output signal is a zero crossing square wave with a fixed amplitude of 6 V peak-to-peak from -1 and + 5 V.

Instantly output your SPAN and ZERO output settings by moving the EZ-CHECK switch between HI and LO. You may also select any third output setting (such as mid-range) using the SET position on the EZ-CHECK switch. The output is adjusted in 1 count increments by turning the knob ③. Press and turn the knob for faster dialing with 100 count increments.

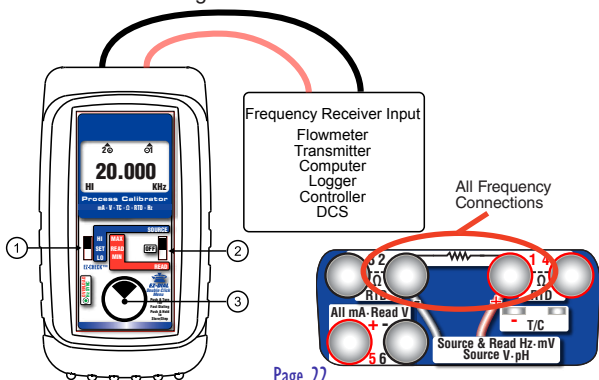



## Read Frequency

Choose this function to count frequency.

Move the power switch ② to READ then Double Click the EZ-DIAL knob to get into the Double Click Menu. Turn the knob to scroll through the settings and press the knob to make your selection. Select FREQ for the FUNCTION and 20KHZ, 10000HZ, 1000HZ or 2000CPM for the RANGE.

Disconnect all input wires from the devices to be calibrated and connect the PIECAL 820 to the output of the device matching polarity.

The green HZ SYNC LED pulses in synch with the input frequency.

Signals above the maximum scale are limited by protection circuitry with "OVER RANGE" on the display and the red OVERLOAD LED lit.

The PIECAL 820 measures the input signal and constantly updates the display with the current reading. Move the EZ-CHECK switch ① to MAX to see the highest reading and to MIN to see the lowest reading. Press and hold the knob ③ to clear the MAX and MIN readings.

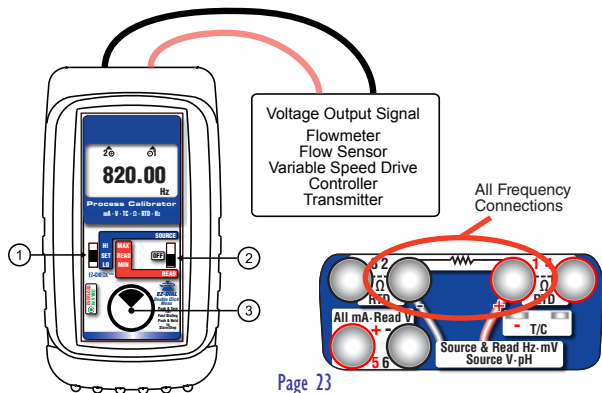

## Specifications

<b>General</b>	
Operating Temp Range	-20 to 60 °C (-5 to 140 °F)
Storage Temp Range	-30 to 60 °C (-22 to 140 °F)
Temperature effect	$\leq \pm 0.01 \% / ^\circ\text{C}$ of Full Scale
Relative Humidity Range	10 % $\leq$ RH $\leq$ 90 % (0 to 35 °C), Non-condensing
	10 % $\leq$ RH $\leq$ 70 % (35 to 60 °C), Non-condensing
Normal Mode Rejection	50/60 Hz, 50 dB
Common Mode Rejection	50/60 Hz, 120 dB
Noise	$\leq \pm \frac{1}{2}$ Least Significant Digit from 0.1 to 10 Hz
Size	5.63x3.00x1.60" 143x76x41mm (LxWxH)
Weight	12.1 ounces, 0.34 kg with boot & batteries
Batteries	Four "AA" Alkaline 1.5V (LR6)
Battery life	Read Functions: $\geq$ 20 hours Source mA: $\geq$ 14 hours @ 12 mA into 250 $\Omega$ Pwr/Meas mA: $\geq$ 12 hours at 20 mA Source V, $\Omega$ , T/C, RTD & Hz: $\geq$ 20 hours
Low Battery	Low battery indication with nominal 1 hour of operation left
Protection against misconnection	Over-voltage protection to 60 vrms (rated for 30 seconds) Red LED indicates OVERLOAD or out of range conditions
Display	High contrast graphic liquid crystal display with 0.315" (8.0 mm) high digits. LED backlighting.

## Specifications

<b>Read mA</b>	
Ranges and Resolution	0.00 to 24.00 mA or -25.0 to 125.0% of 4-20 mA
Accuracy	$\leq \pm (0.03 \% \text{ of Full Scale})$
Voltage burden	$\leq 2\text{V}$ at 24 mA
Overload/Current limit protection	25 mA nominal

<b>Source mA / Power &amp; Measure Two Wire Transmitters</b>	
Ranges and Resolution	0.00 to 24.00 mA or -25.0 to 125.0% of 4-20 mA
Accuracy	$\leq \pm (0.03 \% \text{ of Full Scale})$
Loop compliance voltage	$\geq 24 \text{ DCV @ } 20.00\text{mA}$
Loop drive capability	1200 $\Omega$ at 20 mA for 15 hours nominal; 950 $\Omega$ with Hart Resistor enabled

<b>mA 2-Wire Transmitter Simulation</b>	
Accuracy	Same as Source/Power & Measure
Voltage burden	$\leq 2\text{V}$ at 20 mA
Overload/Current limit protection	25 mA nominal
Loop voltage limits	2 to 60 VDC (fuse-less protected from reverse polarity connections)

## Specifications

### DC Voltage Read

Range and Resolution	-10.00 to 80.00 mV, 0 to 10.25 V, 0.0 to 60.0 V
Accuracy	$\leq \pm 0.03$ % of Full Scale
Input resistance	$\geq 1$ M $\Omega$

### Source V dc

Ranges and Resolution	-10.00 to 80.00 mV, 0 to 10.25 V
Accuracy	$\leq \pm (0.03$ % of Full Scale)
Source Current	$\geq 24$ mA
Sink Current	$> 16$ mA
Output Impedance	$< 1$ Ohm
Short Circuit Duration	Infinite

### Thermocouple Source

Accuracy	$\pm(0.03\%$ of Full Scale) [Note: Full Scale is 80.00 mV]
Cold Junction Compensation	Included in accuracy
Output Impedance	$< 1$ Ohm
Source Current	$> 20$ mA (drives 80 mV into 10 Ohms)

## Specifications

<b>Thermocouple Read</b>	
Accuracy & Cold Junction Compensation	Same as Thermocouple Source
Input Impedance	> 1 Megohms
Open TC Threshold; Pulse	10K Ohms; <5 $\mu$ amp pulse for 300 milliseconds (nominal)

<b>RTD, OHMS and Continuity Read</b>	
Resistance Ranges	0.0 to 401.0, 0 to 4010 Ohms
Accuracy	$\pm(0.03\%$ of Full Scale + 0.075 Ohms)
Excitation Current	1.0 mA to 401.0 Ohms, 0.5 mA to 4010 Ohms (nominal)
Continuity	0.0 to 401.0 Ohms; Beeps from 0.0 to 100.0 Ohms

<b>RTD and OHMS Source</b>	
Accuracy From 1 to 10.2 mA External Excitation Current	$\pm(0.03\%$ of Full Scale + 0.075 Ohms)
Below 1 mA of External Excitation Current	$\pm(0.03\%$ of Full Scale + 0.075 Ohms + $\frac{0.025 \text{ mV}}{\text{mA Excitation Current}}$ )
Resistance Ranges	0.0 to 401.0, 0 to 4010 Ohms
Allowable Excitation Current Range	400 Ohm Range: 10.2 mA max; steady or pulsed/intermittent 4000 Ohms Range: 1 mA max; steady or pulsed/intermittent
Pulsed Excitation Current Compatibility	DC to 0.01 second pulse width

## Specifications

Frequency Source	
Ranges	1 to 2000 CPM, 0.01 to 999.99 Hz, 0.1 to 9999.9 Hz, 0.001 to 20.000 kHz
Accuracy	$\pm(0.03\%$ of Full Scale)
Output Waveform	Square Wave, Zero Crossing -1.0 to +5 V peak-to-peak $\pm 10\%$
Risetime (10 to 90% of amplitude)	< 10 microseconds
Output Impedance	< 1 Ohm
Source Current	> 1 mA rms at 20 kHz
Short Circuit Duration	Infinite
Optical Coupling	Green LED (HZ SYNC) flashes at output frequency

Frequency Read	
Ranges & Accuracy	Same as Frequency Source
Accuracy	$\pm(0.03\%$ of Full Scale)
Trigger Level	1 V rms, dc coupled
Input Impedance	> 1 Meg Ohm + 60 pF

## Thermocouple Ranges & Accuracies

Based on  $\pm(0.03\%$  of 80 mV)

T/C	Degrees C Range	°C	Degrees F Range	°F
J	-200.0 to -150.0	$\pm 1.2^\circ$	-328.0 to -238.0	$\pm 2.0^\circ$
	-150.0 to -50.0	$\pm 0.7^\circ$	-238.0 to -58.0	$\pm 1.3^\circ$
	-50.0 to 100.0	$\pm 0.5^\circ$	-58.0 to 212.0	$\pm 0.9^\circ$
	100.0 to 1200.0	$\pm 0.4^\circ$	212.0 to 2192.0	$\pm 0.8^\circ$
K	-230.0 to -150.0	$\pm 2.6^\circ$	-382.0 to -238.0	$\pm 4.7^\circ$
	-150.0 to 0.0	$\pm 1.0^\circ$	-238.0 to 32.0	$\pm 1.8^\circ$
	0.0 to 1100.0	$\pm 0.6^\circ$	32.0 to 2012.0	$\pm 1.1^\circ$
	1100.0 to 1371.1	$\pm 0.7^\circ$	2012.0 to 2500.0	$\pm 1.2^\circ$
T	-260.0 to -230.0	$\pm 6.1^\circ$	-436.0 to -382.0	$\pm 11.0^\circ$
	-230.0 to -150.0	$\pm 2.2^\circ$	-382.0 to -238.0	$\pm 4.0^\circ$
	-150.0 to 50.0	$\pm 1.1^\circ$	-238.0 to 122.0	$\pm 2.0^\circ$
	50.0 to 300.0	$\pm 0.5^\circ$	122.0 to 572.0	$\pm 1.0^\circ$
	300.0 to 400.0	$\pm 0.4^\circ$	572.0 to 752.0	$\pm 0.7^\circ$
E	-240.0 to -150.0	$\pm 2.5^\circ$	-400.0 to -238.0	$\pm 4.5^\circ$
	-150.0 to -50.0	$\pm 0.7^\circ$	-238.0 to -58.0	$\pm 1.1^\circ$
	-50.0 to 150.0	$\pm 0.4^\circ$	-58.0 to 302.0	$\pm 0.8^\circ$
	150.0 to 1000.0	$\pm 0.3^\circ$	302.0 to 1832.0	$\pm 0.6^\circ$
R	-18.3 to 50.0	$\pm 6.5^\circ$	-1.0 to 122.0	$\pm 11.7^\circ$
	50.0 to 500.0	$\pm 3.7^\circ$	482.0 to 932.0	$\pm 6.6^\circ$
	500.0 to 800.0	$\pm 2.2^\circ$	932.0 to 1472.0	$\pm 4.0^\circ$
	800.0 to 1767.8	$\pm 2.0^\circ$	1472.0 to 3214.0	$\pm 3.5^\circ$

## Thermocouple Ranges & Accuracies

Based on  $\pm(0.03\%$  of 80 mV)

T/C	Degrees C Range	°C	Degrees F Range	°F
<b>S</b>	-18.3 to 50.0	$\pm 6.1^\circ$	-1.0 to 122.0	$\pm 10.9^\circ$
	50.0 to 300.0	$\pm 3.7^\circ$	122.0 to 572.0	$\pm 6.6^\circ$
	300.0 to 600.0	$\pm 2.6^\circ$	572.0 to 1112.0	$\pm 4.7^\circ$
	600.0 to 1767.8	$\pm 2.3^\circ$	1112.0 to 3214.0	$\pm 4.2^\circ$
<b>B</b>	315.6 to 600.0	$\pm 7.9^\circ$	600.0 to 1122.0	$\pm 14.2^\circ$
	600.0 to 1050.0	$\pm 4.0^\circ$	1122.0 to 1922.0	$\pm 7.3^\circ$
	1050.0 to 1400.0	$\pm 2.5^\circ$	1922.0 to 2552.0	$\pm 4.6^\circ$
	1400.0 to 1820.0	$\pm 2.1^\circ$	2552.0 to 3308.0	$\pm 3.8^\circ$
<b>N</b>	-230.0 to 0.0	$\pm 4.2^\circ$	-382.0 to 32.0	$\pm 7.5^\circ$
	0.0 to 450.0	$\pm 0.9^\circ$	32.0 to 842.0	$\pm 1.7^\circ$
	450.0 to 1150.0	$\pm 0.6^\circ$	842.0 to 2102.0	$\pm 1.1^\circ$
	1150.0 to 1300.0	$\pm 0.7^\circ$	2102.0 to 2372.0	$\pm 1.2^\circ$
<b>G (W)</b>	100.0 to 300.0	$\pm 4.5^\circ$	212.0 to 572.0	$\pm 8.2^\circ$
	300.0 to 650.0	$\pm 2.1^\circ$	572.0 to 1202.0	$\pm 3.7^\circ$
	650.0 to 1800.0	$\pm 1.3^\circ$	1202.0 to 3272.0	$\pm 2.4^\circ$
	1800.0 to 2320.0	$\pm 1.9^\circ$	3272.0 to 4208.0	$\pm 3.5^\circ$
<b>C (W5)</b>	-1.1 to 200.0	$\pm 1.8^\circ$	30.0 to 392.0	$\pm 3.2^\circ$
	200.0 to 1350.0	$\pm 1.4^\circ$	392.0 to 2462.0	$\pm 2.6^\circ$
	1350.0 to 2000.0	$\pm 1.9^\circ$	1742.0 to 3632.0	$\pm 3.4^\circ$
	2000.0 to 2320.0	$\pm 2.6^\circ$	3632.0 to 4208.0	$\pm 4.7^\circ$



## Thermocouple Ranges & Accuracies

Based on  $\pm(0.03\%$  of 80 mV)

T/C	Degrees C Range	°C	Degrees F Range	°F
<b>D</b> (W3)	-1.1 to 400.0	$\pm 2.5^\circ$	30.0 to 752.0	$\pm 4.5^\circ$
	400.0 to 1500.0	$\pm 1.3^\circ$	752.0 to 2732.0	$\pm 2.4^\circ$
	1500.0 to 2000.0	$\pm 2.3^\circ$	2732.0 to 3632.0	$\pm 3.0^\circ$
	2000.0 to 2320.0	$\pm 2.6^\circ$	3632.0 to 4208.0	$\pm 4.6^\circ$
<b>P</b> Platinel	0.0 to 150.0	$\pm 0.8^\circ$	32.0 to 302.0	$\pm 1.5^\circ$
	150.0 to 1100.0	$\pm 0.6^\circ$	302.0 to 2012.0	$\pm 1.1^\circ$
	1100.0 to 1395.0	$\pm 0.8^\circ$	2012.0 to 2543.0	$\pm 1.5^\circ$
<b>L</b> J-DIN	-200.0 to 0.0	$\pm 0.7^\circ$	-328.0 to 32.0	$\pm 1.3^\circ$
	0.0 to 550.0	$\pm 0.5^\circ$	32.0 to 1022.0	$\pm 0.8^\circ$
	550.0 to 900.0	$\pm 0.4^\circ$	1022.0 to 1652.0	$\pm 0.7^\circ$
<b>U</b> T-DIN	-200.0 to -25.0	$\pm 1.4^\circ$	-328.0 to -13.0	$\pm 2.6^\circ$
	-25.0 to 100.0	$\pm 0.7^\circ$	-13.0 to 212.0	$\pm 1.2^\circ$
	100.0 to 300.0	$\pm 0.5^\circ$	212.0 to 572.0	$\pm 0.9^\circ$
	300.0 to 600.0	$\pm 0.4^\circ$	572.0 to 1112.0	$\pm 0.7^\circ$

## RTD Ranges & Accuracies

Based on  $\pm(0.03\%$  of  $400\Omega$ ) / Pt  $1000\Omega$  Based on  $\pm(0.03\%$  of  $4000\Omega$ )

RTD Type	Degrees C Range	°C	Degrees F Range	°F
Pt 100 Ohm DIN/IEC/JIS 1989 1.3850 (ITS-90)	-200.0 to 120.0	$\pm 0.5^\circ$	-328.0 to 248.0	$\pm 0.9^\circ$
	120.0 to 430.0	$\pm 0.6^\circ$	248.0 to 806.0	$\pm 1.0^\circ$
	430.0 to 850.0	$\pm 0.7^\circ$	806.0 to 1562.0	$\pm 1.2^\circ$
Pt 100 Ohm (Burns) 1.3902	-195.6 to 160.0	$\pm 0.5^\circ$	-320.0 to 320.0	$\pm 0.9^\circ$
	160.0 to 460.0	$\pm 0.6^\circ$	320.0 to 860.0	$\pm 1.0^\circ$
	460.0 to 648.9	$\pm 0.7^\circ$	860.0 to 1200.0	$\pm 1.2^\circ$
Pt 100 Ohm (Old JIS 1981) 1.3916	-200.0 to 170.0	$\pm 0.5^\circ$	-328.0 to 338.0	$\pm 0.9^\circ$
	170.0 to 480.0	$\pm 0.6^\circ$	338.0 to 896.0	$\pm 1.0^\circ$
	480.0 to 648.9	$\pm 0.7^\circ$	896.0 to 1200.0	$\pm 1.2^\circ$
Pt 100 Ohm (US Lab) 1.3926	-200.0 to 180.0	$\pm 0.5^\circ$	-328.0 to 356.0	$\pm 0.9^\circ$
	180.0 to 490.0	$\pm 0.6^\circ$	356.0 to 914.0	$\pm 1.0^\circ$
	490.0 to 850.0	$\pm 0.7^\circ$	914.0 to 1562.0	$\pm 1.2^\circ$
Pt 1000 Ohm DIN/IEC/JIS 1989 1.3850	-200.0 to 120.0	$\pm 0.5^\circ$	-328.0 to 248.0	$\pm 0.9^\circ$
	120.0 to 430.0	$\pm 0.6^\circ$	248.0 to 806.0	$\pm 1.0^\circ$
	430.0 to 850.0	$\pm 0.7^\circ$	806.0 to 1562.0	$\pm 1.2^\circ$
Copper 10 Ohm 1.4274 (Minco)	-200.0 to 260.0	$\pm 5.1^\circ$	-328.0 to 500.0	$\pm 9.2^\circ$
Copper 50 Ohm 1.4280	-50.0 to 150.0	$\pm 0.9^\circ$	-58.0 to 302.0	$\pm 1.7^\circ$
Ni 120 Ohm 1.6720 (Pure)	-80.0 to 260.0	$\pm 0.3^\circ$	-112.0 to 500.0	$\pm 0.5^\circ$
Ni 110 Ohm (Bristol 7 NA) 1.5801	-100.0 to 260.0	$\pm 0.3^\circ$	-148.0 to 500.0	$\pm 0.5^\circ$

## Warranty

Our equipment is warranted against defective material and workmanship (excluding batteries) for a period of three years from the date of shipment. Claims under warranty can be made by returning the equipment prepaid to our factory. The equipment will be repaired, replaced or adjusted at our option. The liability of Practical Instrument Electronics (PIE) is restricted to that given under our warranty. No responsibility is accepted for damage, loss or other expense incurred through sale or use of our equipment. Under no condition shall Practical Instrument Electronics, Inc. be liable for any special, incidental or consequential damage.

## Accessories

### INCLUDED:

- Four "AA" Alkaline batteries, Certificate of Calibration
- Evolution Hands Free Carrying Case                      Part No. 020-0211
- Dark Blue Rubber Boot    Part No. 020-0213
- PIE Multifunction Wire Kit    Part No. 020-0820
  - 1 Red & 1 Black Lead with Banana Plug & Alligator Clips
  - 2 Red & 2 Black Leads with Banana Plugs & Spade Lugs

### OPTIONAL:

- Ni-MH 1 Hour Charger with 4 Ni-MH AA                      Part No. 020-0103
- Batteries (100-120 V AC input for North America Only)
- T/C Wire Kit 1\* for Types J, K, T & E                      Part No. 020-0202
- T/C Wire Kit 2\* for Types B, R/S & N                      Part No. 020-0203

\* Thermocouple extension wire, stripped on one end with a corresponding miniature thermocouple male connector on the other end.

## Additional Information

PIE Calibrators are manufactured in the USA. This product is calibrated on equipment traceable to NIST and includes a Certificate of Calibration. Test Data is available for an additional charge.

Practical Instrument Electronics recommends a calibration interval of one year. Contact your local representative for recalibration and repair services.



## Practical Instrument Electronics

82 East Main Street Suite 3.14

Webster, NY 14580 USA

Tel: 585.872.9350 • Fax: 585.872.2638

sales@piecal.com • www.piecal.com

Copyright © 2015 All rights reserved

820-9002 - Rev F 24 July 2015