



The HOBO Micro Station is a weatherproof data logger designed for applications requiring multi-channel monitoring of microclimates in one or more locations. With its rugged, compact design, this battery-powered logger supports five plug-and-play smart sensors. You can quickly mount the logger on a stake, flat surface, or mast using the logger's built-in mounting tabs. With HOBOWare, you can easily configure the logger, check the status, and download data for graphing and analysis (available at [www.onsetcomp.com/hoboware-free-download](http://www.onsetcomp.com/hoboware-free-download)).

## HOBO Micro Station

H21-USB

### Included Items:

- Four AA 1.5 V alkaline batteries
- Rubber plugs
- Grease packet
- Screws and washers
- Cable ties

### Required Items:

- HOBOWare
- USB cable
- Onset® smart sensors

### Optional Items:

- Lithium batteries (HWSB-LI)
- Ground wire (CABLE-MICRO-G)
- 2-meter tripod (M-TPB)
- 3-meter tripod (M-TPA)
- 1.5-meter mounting pole (M-MPB)
- 1-5/8 inch U-bolts (U-BOLT-KIT2)

Smart sensors and accessories are available at [www.onsetcomp.com](http://www.onsetcomp.com).

## Specifications

<b>Operating Range</b>	-20° to 50°C (-4° to 122°F) with alkaline batteries -40 to 70°C (-40 to 158°F) with lithium batteries
<b>Smart Sensor Connectors</b>	5
<b>Smart Sensor Network Cable Length</b>	100 m (328 ft) maximum
<b>Logging Interval</b>	1 second to 18 hours
<b>Start Modes</b>	Immediate, at interval, push button, or delayed start
<b>Memory Modes</b>	Stop when full or wrap when full
<b>Memory</b>	512 KB nonvolatile flash data storage
<b>Time Accuracy</b>	0 to 2 seconds for the first data point and ±5 seconds per week at 25°C (77°F)
<b>Battery Type</b>	Four AA 1.5 V alkaline batteries for operating conditions of -20° to 50°C (-4° to 122°F); four AA 1.5 V lithium batteries for operating conditions of -40 to 70°C (-40 to 158°F)
<b>Battery Life</b>	1 year, typical use (up to five sensors with 1 minute or greater logging interval)
<b>Communication Type</b>	USB 2.0 interface
<b>Full Memory Download Time</b>	4 minutes
<b>Enclosure Access</b>	Hinged door secured by one latch with eyelet for use with user-supplied padlock
<b>Materials</b>	Outer enclosure: Polycarbonate/PBT blend with stainless steel hinge pins; Gasket: Silicone foam; Cable channel: EPDM rubber
<b>Dimensions</b>	17.04 x 11.94 x 4.47 cm (6.71 x 4.70 x 1.76 in.) see diagrams below Padlock hole diameter: 0.58 cm (0.23 in.)
<b>Weight</b>	414 g (14.6 oz)
<b>Environmental Rating</b>	Weatherproof enclosure, NEMA 4X and IP66
<b>CE</b>	The CE Marking identifies this product as complying with all relevant directives in the European Union (EU).

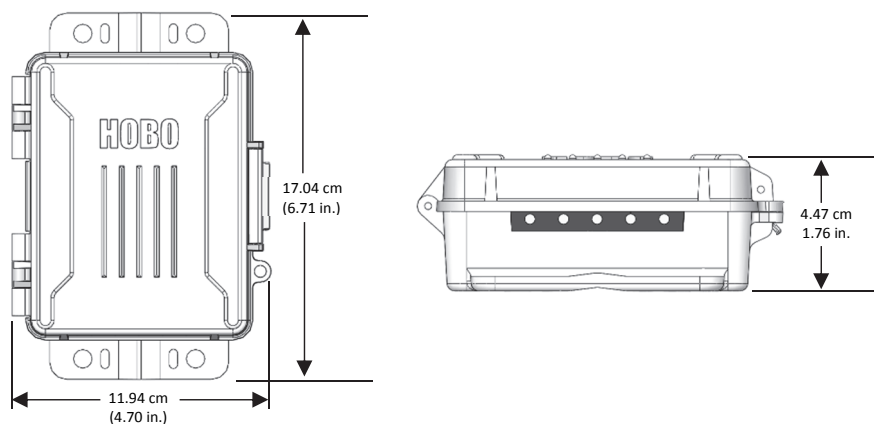

## Logger Components and Operation

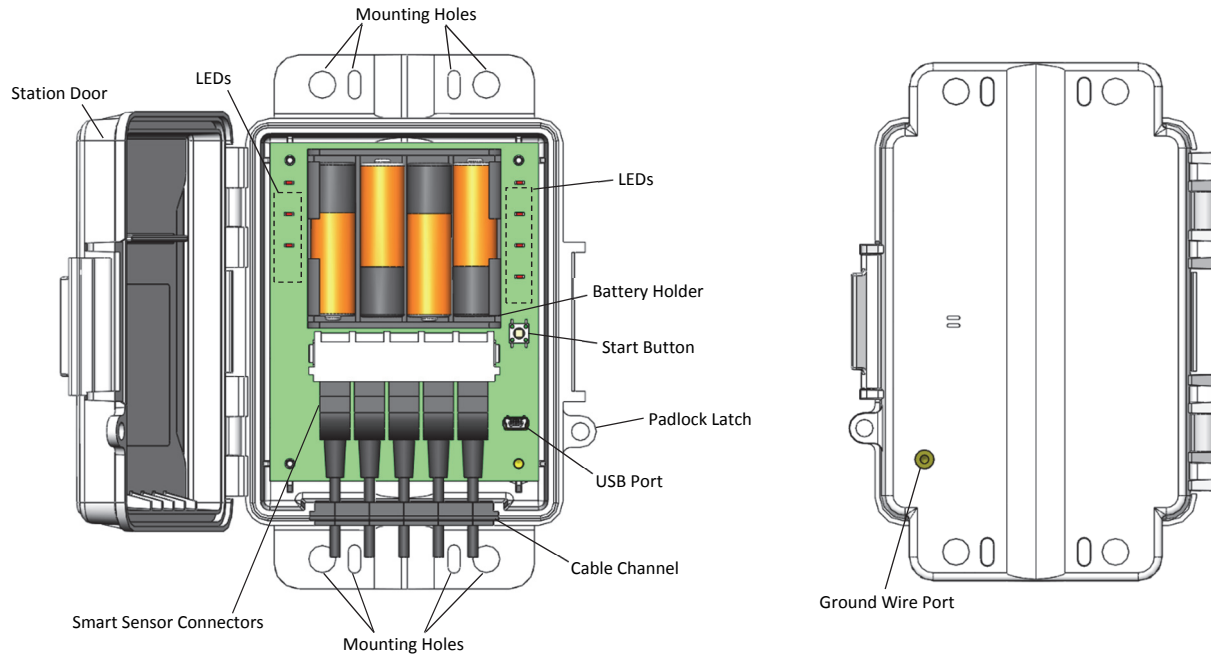

**Station Door:** This is the protective, hinged door covering the batteries and electronics.

**Smart Sensor Connectors:** Use these input jacks to connect up to five smart sensors as shown (see *Setting up and Starting the Micro Station*). Note that some smart sensors have more than one data channel (see sensor manual for details).

**Mounting Holes:** Use the inner or outer holes at the top and bottom of the logger to mount it (see *Deploying and Mounting the Logger*).

**Cable Channel:** Use this rubber cable channel for inserting smart sensor cables or rubber plugs to create a weatherproof seal (see *Deploying and Mounting the Logger*).

**USB Port:** Use this port to connect the station to the computer via USB cable.

**Padlock Latch:** Use this latch to attach a 1-3/16 inch padlock to the logger for security.

**Start Button:** Press this button for 3 seconds to start the logger when it is configured to start “On button push” (see *Setting up and Starting the Micro Station*). The button start LED will blink when the logger is waiting for you to press the start button. All the LEDs will blink once you press the button to start logging.

**Battery Holder:** The location where the AA batteries are installed as shown (see *Battery Information*).

**Ground Wire Port:** Use this port on the back of the logger to connect a ground wire (CABLE-MICRO-G). See *Deploying and Mounting the Logger*.

**LEDs:** There are seven LEDs that indicate logger activity and status. The following table describes all the LEDs.

LED	Description
<b>Battery Low</b>	This LED blinks when the battery power is less than 25% capacity. See <i>Battery Information</i> for details on replacing the batteries.

LED	Description
<b>Memory Low</b>	This LED blinks when less than 25% of memory is available (if the logger was configured to stop logging when the memory fills).
<b>Error</b>	This LED indicates a sensor communication failure has occurred. If this LED is blinking in conjunction with the OK LED, there was a communication failure. The system has recovered, but there may be an intermittent problem. If this is the only LED blinking, at least one sensor is currently not communicating. Read out the logger and investigate the problem as soon as possible. See <i>Troubleshooting</i> for more details.
<b>Delay Start</b>	This LED blinks when the logger has been configured to start at a specific date/time or the next interval.
<b>Button Start</b>	This LED blinks when the logger has been configured with a push button start. Press and hold the start button for 3 seconds for logging to begin.
<b>Sensor Activity</b>	This LED blinks during normal communication between the logger and the sensors.
<b>OK</b>	This LED blinks every 2 seconds during logging.

## Setting up and Starting the Micro Station

Follow these steps to set up the station.

- 1. Install the batteries.** Open the logger door and insert four AA batteries observing polarity. See *Battery Information* for details.
- 2. Plug in smart sensors and install the rubber cable channel.**

**Important:** Proper installation of the rubber cable channel is required for outdoor and weatherproof deployments and in harsh indoor environments.

- a. Remove the rubber cable channel making note of how it is oriented.

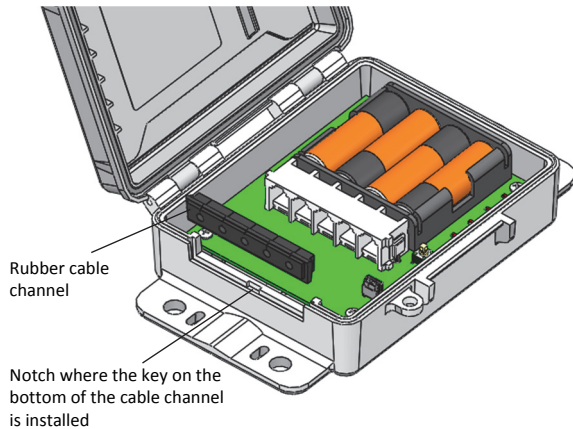

- b. Plug the smart sensors into the connectors. When using multiple smart sensors, it is easiest to start by plugging one into the leftmost or rightmost connector and then working your way across the connectors in order.
- c. Lightly coat each smart sensor cable with a small amount of silicone grease (about the size of a pea). Only the portion of the cable that will be in the channel needs to be greased. Also lightly coat the bottom and two sides of the cable channel.
- d. Install the cables in the cable channel. There is a break in the rubber above each hole to guide the cable into the hole. Make sure the cable channel is oriented with the breaks pointed up and the key pointed down and closer to the sensor connectors to ensure proper reinstallation in the next step. Slightly bend the ends of the channel to reveal the breaks and push the cable into the hole that lines up with the corresponding sensor connector. Repeat for any additional sensors.
- e. Reinstall the cable channel making sure the key on the bottom is inserted in the notch in the logger enclosure pointed out in the diagram above. Once the cable channel is properly seated, the top will be flush with the edge of the logger enclosure. Adjust the cable slack as necessary so a minimum amount of cable is inside the case as shown below.

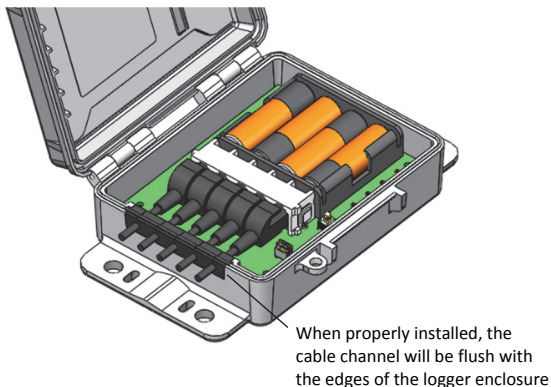

- f. If you will be using less than five smart sensors, use the rubber plugs to fill any empty holes in the cable channel. Lightly coat the rubber plugs with a small amount of grease. Insert the thin part of the plug into the hole. While pulling the thin end of the plug from the inside of the case, push the other end of the plug from the outside until the thick part of the plug fills the hole.

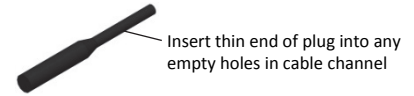

3. **Set up HOBOWare.** Even though this logger uses a USB cable to communicate with HOBOWare, the software and computer must be configured for a serial COM port for each H21-USB station (even if your computer does not have a serial port). HOBOWare 3.7.11 or later is recommended.

**Important:** USB 2.0 specifications do not guarantee operation outside the range of 0°C (32°F) to 50°C (122°F).

If you need to install or upgrade HOBOWare:

- a. Connect the logger to the computer with the USB cable. Device hardware drivers will be installed automatically the first time an H21-USB logger is connected. This may take a few minutes to complete.

**Important:** The computer must be connected to the Internet while the device hardware drivers are being installed. Device drivers only need to be installed once per computer. If you need to use another computer with an H21-USB Micro Station, you will need to repeat this installation. Contact Onset Technical Support at [www.onsetcomp.com/support/contact](http://www.onsetcomp.com/support/contact) if you encounter any problems with device hardware driver installation.

- b. Download HOBOWare at [www.onsetcomp.com/hoboware-free-download](http://www.onsetcomp.com/hoboware-free-download) and install the software.
- c. When the HOBOWare Setup Assistant appears, select "USB and serial devices" for the device types. A COM port should be listed. Complete the remaining Setup Assistant steps and click OK.

If HOBOWare is already installed:

- a. Connect the logger to the computer with the USB cable. Device hardware drivers will be installed automatically the first time an H21-USB logger is connected. This may take a few minutes to complete.

**Important:** The computer must be connected to the Internet while the device hardware drivers are being installed. Device drivers only need to be installed once per computer. If you need to use another computer with an H21-USB Micro Station, you will need to repeat this installation. Contact Onset Technical Support at [www.onsetcomp.com/support/contact](http://www.onsetcomp.com/support/contact) if you encounter any problems with device hardware driver installation.

- b. Open HOBOWare. From the File menu (Windows) or the HOBOWare menu (Macintosh), select Preferences.

- c. In HOBOWare Preferences, select Communications. Click Device Types and make sure “USB and serial devices” is selected.
- d. Click Serial Ports. A new COM port is listed under Serial Ports, which will be used for the Micro Station. Make sure the box next to the new COM port is checked.
- e. Click OK in Preferences.

**Note:** If you are using a version of HOBOWare prior to 3.7.10, you may need to enable a COM port in Preferences as described above each time you connect a different H21-USB station to the computer.

#### 4. Launch the logger.

- a. From the Device menu in HOBOWare, select Launch.
- b. Type a name for the deployment (optional), which will be used as the default file name when you read out the logger. If no name is entered, the logger serial number is used.
- c. Type user notes to enter up to 2,000 characters of information about the deployment (optional).
- d. Check that all sensors plugged in are listed in the Launch Logger window; these are the sensors that will be logged. Sensors are listed in ascending order by serial number. If you add or remove sensors while this window is open, click the Refresh button to update the sensor list.
- e. Type a label for each sensor (optional).
- f. Click the Filters button to create any additional filtered series, such as average temperature per day. The filtered series will be available when you read out the logger and plot the data.
- g. Click the Scaling button to add scaling to any sensors that support scaling (optional).
- h. Select a logging interval from 1 second to a maximum of 18 hours, 12 minutes, and 15 seconds.
- i. Select a sampling interval (optional). When a sampling interval is configured, the station will take multiple measurements within a given logging interval and then average them together to create a single logged data point. This is only an option for the following smart sensors that support measurement averaging: temperature (S-TMB-M0xx), PAR (S-LIA-M003), solar radiation (S-LIB-M003), barometric pressure (S-BPA-CM10 and S-BPB-CM50), 4-20mA input (S-CIA-CM14), 12-bit voltage input (S-VIA-CM14), and FlexSmart TRMS module (S-FS-TRMSA-D). Disable the sampling interval if none of your smart sensors support measurement averaging to avoid unnecessary drain on the battery power.
- j. Select when to start logging:
  - **Now.** Logging begins immediately.
  - **At Interval.** Logging will begin at the next even interval as determined by the selected logging interval.

- **On Date/Time.** Logging will begin at a date and time you specify.
- **Push Button.** Logging will begin once you press the button on the logger for 3 seconds.
- **Save Settings in Logger.** Logging will not start, but the launch settings selected will be saved for later.

k. Select when to stop logging:

- **When Memory Fills.** The logger will record data until the memory is full.
- **Never (Wrap When Full).** The logger will continue recording data indefinitely, with newest data overwriting the oldest.

- l. Click the Start button to load the settings to the logger. Logging will begin based on the settings you selected. If you configured the logger with a push button start, press the button on the logger for 3 seconds when you are ready for logging to begin.

See *Reading Out the Logger* for details on downloading. See *Deploying and Mounting the Logger* for deployment guidelines and mounting instructions.

### Reading Out the Logger

To download data from the logger:

1. Open the door on the logger and connect it to the computer with a USB cable.
2. From the Device menu in HOBOWare, select Readout. If the logger is logging, select whether to stop or continue logging.
3. After the readout is complete, plot the data. Refer to the HOBOWare Help for details on working with the data.

**Note:** If you are using a version of HOBOWare prior to 3.7.10, you may need to enable a new COM port as described in *Setting up and Starting the Micro Station* each time you connect a different H21-USB station to the computer.

### Logger Memory

The logger contains 512 KB of non-volatile memory, which is retained even if the batteries are removed. Up to 10 KB of the memory is used to store configuration settings with the remainder used for data storage. HOBOWare estimates how long the logger will record data until the memory is full (the run time) based on the logging interval and the number and type of sensors connected. The following figure shows the expected run time for several logging intervals based on the total number of bits in use by the logger, which is determined by adding the bits per sample for each sensor measurement used by the logger. For example, a Micro Station with a temperature sensor (12 bits), wind speed (16 bits), and two temperature/RH sensors (22 bits each) uses 72 total bits. Refer to the Specifications in each sensor manual for the bits per sample.

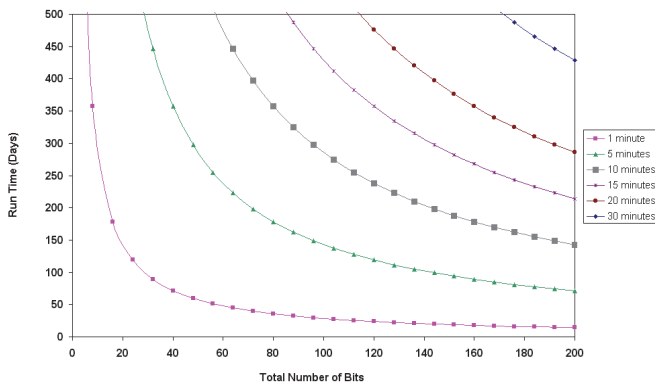

## Adding or Removing Sensors

Sensors can be added or removed while the logger is stopped or while the logger is waiting to start because it was configured to start logging on a specific date/time or with a push button start. To add or remove smart sensors from the logger:

1. Open the door on the logger and connect it to the computer with a USB cable.
2. Read out and stop the logger with HOBOWare.
3. Remove the rubber cable channel and unplug any smart sensors you wish to remove.
4. For each smart sensor you are adding, lightly coat the smart sensor cable with a small amount of silicone grease (about the size of a pea).
5. Feed the smart sensor cables through the holes in the cable channel.
6. Plug in the smart sensors and reinstall the cable channel. Use rubber plugs to fill any empty holes as described in *Setting up and Starting the Micro Station*.
7. Configure the logger with HOBOWare and start it again.

Notes:

- If you remove a sensor while the logger is logging, the Error status light will blink at the next logging interval. The data for that sensor will then display as missing or erroneous in readouts.
- If you add a sensor while the logger is logging, it will be ignored. Logging will continue normally for the other sensors.
- The logger can work with a maximum of 100 meters (328 feet) of smart sensor network cable, which is the digital communications portion of the sensor cables. If you are using multiple sensors, check the length of each smart sensor network cable listed in the specifications in the sensor's manual and make sure the combined length does not exceed 100 meters (328 feet).

## Deploying and Mounting the Logger

Follow the guidelines and steps in this section for deploying and mounting the logger.

## Deployment Guidelines

When deploying the logger:

- Make sure the logger remains in a vertical position once it is placed in its deployment location to prevent pooling of water on the cable entries.
- If possible, avoid sites immediately adjacent to radio/television/microwave towers and equipment. In rare situations, strong electromagnetic interference may result in sensor network errors.
- Take note of the mounting considerations in the sensor manuals for additional guidelines for the sensors you are using.
- If you are using a wind speed/direction sensor or if the station will be installed on a roof or in a location with exposure to lightning, use a ground wire (CABLE-MICRO-G). See *Installing the Ground Wire*.
- Make sure all smart sensor cables are fastened securely, routed through the rubber cable channel. Any empty holes in the cable channels need to be filled with a rubber plug to ensure the station is weatherproof. See *Setting up and Starting the Micro Station*.
- Do not store excess sensor cable wire coiled inside the station case or within one foot outside the case.
- Protect cables and wires with conduit. Exposed cables can be chewed by rodents.
- Make sure the total cable length for all installed smart sensors does not exceed 100 m (328 ft).
- Consider using a padlock to restrict access to the logger. With the door closed, hook a padlock through the latch on the right side of the door and lock it.

## Installing the Ground Wire

If you are using a ground wire (CABLE-MICRO-G), attach it to the ground wire port on the back of the logger. Use the screw and washer included with the ground wire to attach it to the port.

- If you are mounting the logger on a tripod or mast, use the optional U-bolts (U-BOLT-KIT2). Attach the ground wire under one of the nuts on one end of the U-bolt.
- If you are mounting the logger on a metal post, clamp the ground wire to the metal post with a hose clamp or a 1-5/8 inch U-bolt.
- If mounting to a flat surface, attach the ground wire to a proper ground. Note that the ground wire may prevent the logger from being flat against the surface. Be careful not to bend the case when tightening screws.

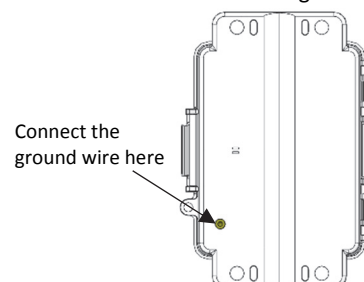

### Mounting the Logger

There are three ways to mount the logger using the built-in mounting tabs:

- Use the two sets of outer holes and 1-5/8 inch saddle-clamp U-bolts to attach the logger to a tripod or mast (this is the recommended method for mounting on a mast). Do not use U-bolts without the saddle clamps as that could bend the mounting tabs and damage the housing or compromise the weatherproof seal. The flat portion of the saddle clamps should be against the mounting tabs.

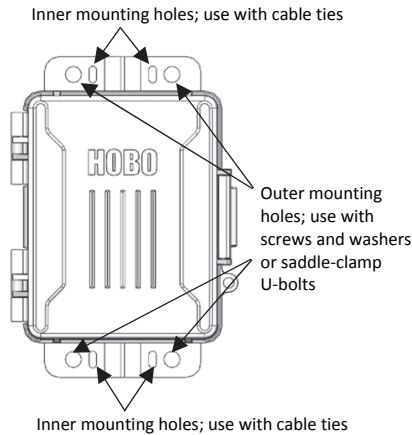

- Use the included cable ties with the two sets of inner holes to affix the logger to a PVC pipe or mast.
- Use the included screws and washers with the two sets of outer holes to adhere the logger to a wall or flat surface.

### Care and Maintenance

The station is designed for outdoor use, but should be inspected periodically. When inspecting the station, do the following:

- Verify the station enclosure is free of visible damage or cracks.
- Make sure the station enclosure is clean. Wipe any dust or grime off with a damp cloth.
- Wipe any water off the station before opening it.
- Check that all cables are free of damage, such as cracks, cuts, and splits.
- Make sure cables are still fastened securely and any conduit is still intact.
- Grease the sides and bottom of the rubber cable channel and the portion of the cables in the cable channel with a small amount of silicone grease.
- Verify that all cables are free of corrosion. If moisture is visible inside the station or if there is any sign of corrosion on the connectors, spray WD-40® or an equivalent electronics-safe corrosion inhibitor on the connectors. This will displace moisture and prevent additional corrosion. Be sure to determine the source of the moisture and fix it. Check the cable channel and cover seal for any sign of moisture entry.

### Troubleshooting

The following table lists common problems you may encounter with the logger and possible resolutions.

Problem	Resolution
Individual sensors are not found or are missing in the Launch Logger window in HOBOWare	<ul style="list-style-type: none"> <li>• If a sensor is removed and then immediately reinstalled, it may not be auto-detected. Click Refresh in the Launch Logger window.</li> <li>• Check for a loose connection between the sensor and the logger.</li> <li>• Make sure you haven't exceeded 100 meters (328 ft) of network cable.</li> </ul>
All sensors are missing in the Launch Logger window in HOBOWare	Remove all but one sensor, then check if the sensor appears in the Launch Logger window (you may need to click the Refresh button). Continue to plug and unplug each sensor one at a time until you find the bad sensor. If you find a bad sensor or if none of the sensors communicate, contact Onset Technical Support.
The Error LED is blinking	<ul style="list-style-type: none"> <li>• If this LED is blinking in conjunction with the OK LED, there was a communication failure. The system has recovered, but there may be an intermittent problem. Check the sensors one at a time to make sure they are all communicating as described in the previous problem. If you find a bad sensor or if none of the sensors communicate, contact Onset Technical Support.</li> <li>• If this is the only LED blinking, at least one sensor is currently not communicating. Look for loose connections. If found, remove the offending sensor and check its wires and connector for damage and/or signs of moisture.</li> <li>• In general, it is recommended that you read out data when this light is blinking, investigate the problem, and restart the logger.</li> </ul>
The Battery Low LED is blinking after the batteries were replaced	<ul style="list-style-type: none"> <li>• Check the polarity; make sure the batteries are installed properly.</li> <li>• Make sure you aren't using a combination of alkaline and lithium batteries. Never mix battery types.</li> <li>• Check the battery expiration date and make sure it is at least two years from the current date. Batteries can lose significant capacity if stored at elevated temperatures.</li> </ul>
Batteries quickly run out of power	<ul style="list-style-type: none"> <li>• Make sure the logging and sampling intervals are set for at least 1 minute. Logging and sampling intervals faster than 1 minute will rapidly deplete the battery. See <i>Battery Information</i> for more details.</li> <li>• Check for damaged wiring and/or sensors. Damaged cables or connectors can result in complete or partial short circuits that will rapidly drain batteries.</li> </ul>
No LEDs are flashing	<ul style="list-style-type: none"> <li>• Make sure the batteries still have power. Batteries should have at least 1 V per cell.</li> <li>• The memory may be full. Read out the logger and start it again.</li> <li>• The launch configuration settings may not have been loaded to the logger. Check the status with HOBOWare.</li> </ul>

Problem	Resolution
OK LED is not flashing	<ul style="list-style-type: none"> <li>Check the other LEDs. If the Delay Start LED is blinking, logging will begin at the date/time you selected or the next interval. If the Button Start LED is blinking, logging will begin once you press the button on the logger for 3 seconds.</li> <li>The launch configuration settings may not have been loaded to the logger. Check the status with HOBOWare.</li> </ul>
Data file can't be opened	The data file may be corrupted. Read out the logger again and try opening the file. If that does not work, contact Onset Technical Support.
Data file contains errors	If data is missing for a particular sensor, check that the sensor was installed correctly. Unplug the sensor and then plug it back in. Make sure the sensor appears in the Launch Logger window in HOBOWare (you may need to click the Refresh button). If it does not, contact Onset Technical Support.
Logger is not found in HOBOWare	<ul style="list-style-type: none"> <li>The logger requires a COM port in HOBOWare. Open the Preferences and click Communications. Under Device Types, make sure "USB and serial devices" is selected. Under Serial Ports, make sure all COM ports are selected. Click OK to save your changes. You may need to repeat this each time you connect a different Micro Station to the computer.</li> <li>Make sure the USB cable is fully inserted in the USB port.</li> <li>Make sure the batteries have power and replace them if necessary.</li> </ul>

**⚠ WARNING:** Do not cut open, incinerate, heat above 85°C (185°F), or recharge the lithium batteries. The batteries may explode if the logger is exposed to extreme heat or conditions that could damage or destroy the battery cases. Do not mix battery types, either by chemistry or age; batteries may rupture or explode. Do not dispose of the logger or batteries in fire. Do not expose the contents of the batteries to water. Dispose of the batteries according to local regulations for lithium batteries.

## Battery Information

The logger requires four user-replaceable AA 1.5 V alkaline or optional lithium batteries for operation at the extreme ends of the logger operating range. Expected battery life varies based on the ambient temperature where the logger is deployed, the logging or sampling intervals selected, and number of sensors connected. Battery life is 1 year typical with a logging interval of 1 minute and sampling intervals disabled or with a logging interval of 10 minutes or more and a sampling interval of 1 minute. Deployments in extremely cold or hot temperatures or a logging or sampling interval faster than 1 minute can impact battery life. Estimates are not guaranteed due to uncertainties in initial battery conditions and operating environment.

To replace the batteries:

1. Open the door on the logger.
2. Remove the old batteries.
3. Insert four new batteries observing polarity.