



MONARCH INSTRUMENT

Instruction Manual



Nova-Pro® Ultra Violet UV365, UV385 Stroboscope/Lamp/Tachometer

15 Columbia Drive • Amherst, NH 03031 USA

Phone: (603) 883-3390 • Fax: (603) 886-3300

E-mail: support@monarchinstrument.com

Website: www.monarchinstrument.com



Safeguards and Precautions



1. Read and follow all instructions in this manual carefully, and retain this manual for future reference.
2. Do not use this instrument in any manner inconsistent with these operating instructions or under any conditions that exceed the environmental specifications stated.



3. CAUTION: UV emitted from this product. Eye or skin irritation may result from exposure. Use appropriate shielding. DO NOT STARE AT THE LIGHT SOURCE

4. Certain strobe frequencies can trigger epileptic seizures in those prone to that type of attack.
5. Objects viewed with this product may appear to be stationary when in fact they are moving at high speeds. Always keep a safe distance from moving machinery and do not touch the target.
6. There are no user serviceable parts in this instrument. Refer service to a qualified technician.
7. This instrument may not be safe for use in certain hazardous environments, and serious personal injury or death could occur as a result of improper use. Please refer to your facility's safety program for proper precautions.
8. Do not clean this instrument with alcohol or other cleaning solvents as these may damage the LEDs.
9. Nova-Pro Battery Packs contain Lithium Ion batteries which must be disposed of in accordance with Federal, State, & Local Regulations. Do not incinerate. Batteries should be shipped to a reclamation facility for recovery of the metal and plastic components as the proper method of waste management. Contact distributor for product return procedures.

LASER MODULE



WARNING - This product emits a visible beam of laser light. Avoid exposure to the laser radiation. The use of optical viewing aids (binoculars, for example) may increase the ocular hazard.

CAUTION - The laser beam should not be intentionally aimed at people or animals.

CAUTION - Use of controls or adjustments or performing procedures other than those specified herein may result in hazardous radiation exposure.



In order to comply with EU Directive 2002/96/EC on Waste Electrical and Electronic Equipment (WEEE): This product may contain material which could be hazardous to human health and the environment. DO NOT DISPOSE of this product as unsorted municipal waste. This product needs to be RECYCLED in accordance with local regulations, contact your local authorities for more information. This product may be returnable to your distributor for recycling - contact the distributor for details.

Monarch Instrument's Limited Warranty applies. Warranty Registration and Extended Warranty coverage available online. See www.monarchinstrument.com for details.

NOVA PRO® is a registered trademark of Monarch Instrument Inc.

TABLE OF CONTENTS:

| | |
|---------------------------------------------------|----------|
| 1. INTRODUCTION | 1 |
| 2. USER INTERFACE | 3 |
| 3. GETTING STARTED | 5 |
| 3.1 Power | 5 |
| 3.1.1 Locked On Continuous Operation | 5 |
| 3.2 Input / Output Connections | 6 |

| | | | | | |
|------------|-----------------------------------------------|--------------|--|--|--|
| 4. | MODES OF OPERATION | 7 | | | |
| 4.1 | STROBE Mode..... | 7 | | | |
| 4.1.1 | Joystick | 7 | | | |
| 4.1.2 | Touch Keypad Entry | 8 | | | |
| 4.1.3 | Doubling or Halving the Flash Rate..... | 8 | | | |
| 4.1.4 | External Input | 9 | | | |
| 4.2 | LAMP Mode..... | 10 | | | |
| 4.3 | LASER Mode | 11 | | | |
| 4.4 | TACH (TACHometer) Mode | 12 | | | |
| 5. | MENU SETTINGS..... | 13-14 | | | |
| 5.1 | Menu Overview | 15 | | | |
| 5.2 | MODE Menu | 15 | | | |
| 5.3 | Brightness (BRITE) Menu..... | 16 | | | |
| 5.3.1 | Degrees..... | 16 | | | |
| 5.3.2 | Time..... | 17 | | | |
| 5.4 | Miscellaneous (MISC) Menu..... | 17 | | | |
| 5.4.1 | DECPY (Decimal Point) Menu | 17 | | | |
| 5.4.2 | UNITS Menu..... | 18 | | | |
| 5.4.3 | INPUT Menu | 19 | | | |
| 5.4.4 | OUTP (OUTPUT) Menu | 19 | | | |
| 5.4.5 | BKLIT (Backlight) | 20 | | | |
| 5.5 | Memory (MEMRY) Menu | 20 | | | |
| 5.5.1 | Save Memory..... | 20 | | | |
| 5.5.2 | Recall Memory..... | 21 | | | |
| 5.6 | JOG Menu..... | 21 | | | |
| 5.6.1 | NONE | 22 | | | |
| 5.6.2 | PHASE | 22 | | | |
| 5.6.3 | TIME | 22 | | | |
| 5.7 | DELAY Menu | 22 | | | |
| 5.7.1 | NONE | 23 | | | |
| 5.7.2 | PHASE..... | 23 | | | |
| 5.7.3 | TIME..... | 23 | | | |
| 5.7.4 | VRPM | 23 | | | |
| 6. | STROBE BRIGHTNESS | 24 | | | |
| 6.1 | Calculating Blur | 24 | | | |
| 6.2 | Brightness in Degrees of Rotation..... | 25 | | | |
| 6.3 | Brightness in Pulse Duration..... | 26 | | | |
| 7. | STROBE DELAY | 26 | | | |
| 7.1 | Internal Phase Delay | 26 | | | |
| 7.2 | External / Laser Delay..... | 27 | | | |
| 7.2.1 | Phase Delay..... | 27 | | | |
| 7.2.2 | Time Delay | 28 | | | |
| 7.2.3 | AUTO—Virtual RPM | 28 | | | |
| 8. | BATTERY PACK | 29 | | | |
| 8.1 | Low Battery Functionality..... | 30 | | | |
| 8.2 | Charging the Battery Pack..... | 30 | | | |
| 9. | AC POWER OPTION | 31 | | | |
| 10. | WALL POWER SUPPLIES | 31 | | | |
| 11. | SPECIFICATIONS | 32 | | | |
| 11.1 | Operating Environment | 33 | | | |
| 11.2 | Compliance | 33 | | | |
| 11.2.1 | Battery Compliance | 33 | | | |
| 11.2.2 | EU Declaration of Conformity | 33 | | | |
| 12. | OPTIONS, ACCESSORIES and SENSORS | 33 | | | |

1. INTRODUCTION

The Nova-Pro UV365/385 are portable hand-held UV LED Stroboscope/ Lamps used for inspection and to stop motion of moving objects. They emit UVA light at 365nm or 385nm respectively. They come standard as battery powered and have delay functions which enable the user to delay the flash by degrees or time and do virtual slow motion inspection of rotating and reciprocating objects. Both models have a dedicated Laser Module which can be used to synchronize the strobe flash to a remote target or used as a laser tachometer to determine the speed of rotating objects (Tach Mode).

The features of the Nova-Pro are highlighted in Figure 1 and Table 1.

Figure 1 Nova-Pro Features

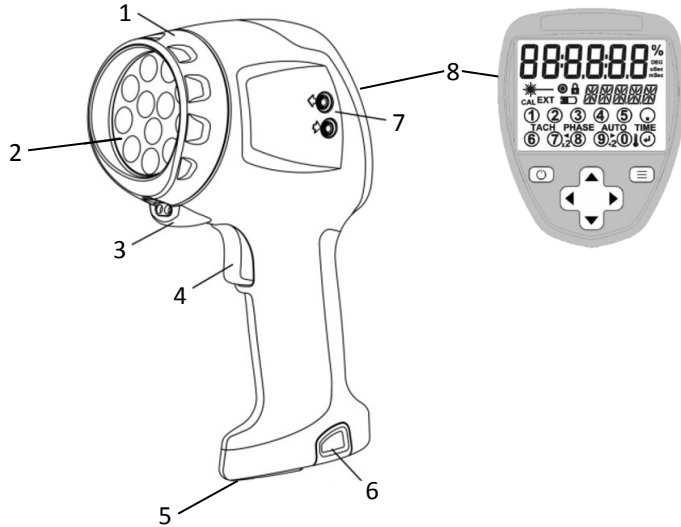

| Table 1 Nova-Pro Features | | |
|---------------------------|----------------------|-------------------------------------------------------------------------------------------------------------------------------------------------------------------------------------------------------------------------------------------|
| 1,2 | Bezel and Lens | Bezel is removable to add or remove the Laser Module. UV Emitted from here! |
| 3 | Laser Module | Internal laser used to synch the flash to an external marker on the object under inspection. Can also be used in Tachometer Mode. |
| 4 | Trigger | Used to activate the unit (when power is on). |
| 5 | Tripod Mount | 1/4 -20 tripod mount for hands free operation . |
| 6 | Power Source | Battery Pack—Removable battery pack. Recharged in the external battery Charger Base OR AC Power—Plug in for continuous power. |
| 7 | Input / Output Jacks | Input jack for external trigger devices. Output jack for pulse sync for other strobes or data systems. |
| 8 | User Interface | <ul style="list-style-type: none"> • Dedicated keypad with “joystick” button for adjusting flash rate. • Backlit LCD (Liquid Crystal Display). • Touch screen keypad for precise flash rate value entry. |

2. USER INTERFACE

The Nova-Pro user interface consists of a large backlit display with touch keypad, dedicated keys on the user interface panel and a trigger to activate the unit when the power is on. The user interface is described in Figure 2 and Table 2.

Figure 2 Nova-Pro User Interface

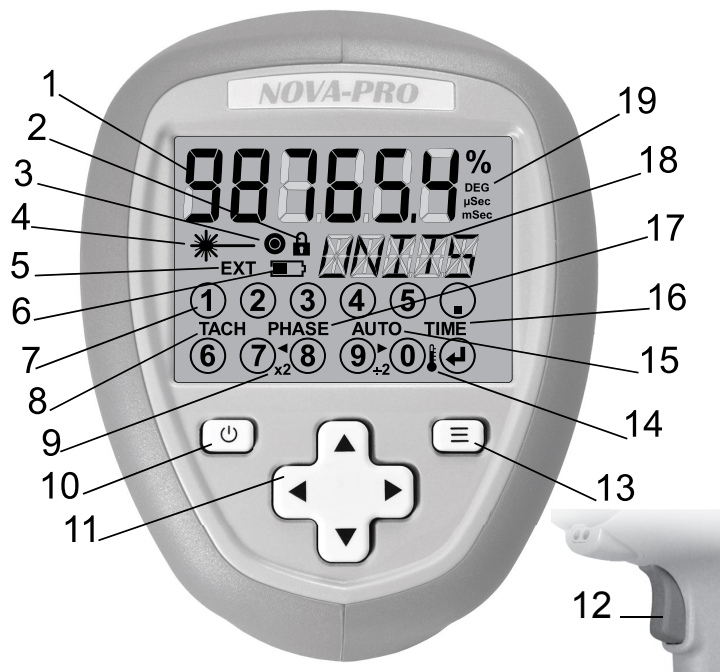

| Table 2 Nova-Pro User Interface | |
|---------------------------------|--------------------------------------------------------------------------------------------------------------------------------------------------------|
| 1 | 6-digit display used to display flash rate and other numeric values. |
| 2 | Lock icon—Active when the device is locked on. |
| 3 | On Target indicator—Active when the input/laser is locked on to a target. Also used to indicate current selection in the menus. |
| 4 | Laser icon—Indicates that the laser is armed (flashing) or on (solid). |
| 5 | EXT icon—Active when an external source is plugged into the unit. |
| 6 | Battery icon—Active when the battery is low. |
| 7 | Touch Keypad—Numeric. Used to directly enter precise flash rates. |
| 8 | TACH icon—Active when Tachometer Mode is selected. |
| 9 | x2, ÷2 and arrows—Used to double or halve the flash rate. |
| 10 | POWER button—Turns the unit on and off. Also used as escape/back button in menus, and locks the strobe on when pushed with the trigger engaged. |
| 11 | Joystick—Adjusts flash rate. Also used for menu navigation. |
| 12 | Trigger—Used to activate the unit when the power is on. |
| 13 | MENU button—Allows access to the menus. Also used to confirm selections. |
| 14 | Temperature icon—Active when the system is over heated. |
| 15 | AUTO icon—Active when unit is in virtual slow motion AUTO VRPM mode. |
| 16 | TIME icon—Active when a TIME DELAY is selected. |
| 17 | PHASE icon—Active when a PHASE DELAY is selected. |
| 18 | 5-digit alphanumeric display used to display units and other statuses. |
| 19 | Engineering units used in menu for brightness and delay parameters. |

3. GETTING STARTED

3.1 Power

The battery powered Nova-Pro has a removable Battery Pack that should be charged before use (See Battery Pack section 8). The Battery Pack is keyed to ensure correct insertion into the Nova-Pro and Battery Charger. **Make sure to remove the tape protecting the battery terminals and charge the battery before use.**





The AC powered Nova-Pro has an external power adapter that must be plugged into an AC outlet (115 Vac or 230 Vac) using the appropriate connector. Interchangeable plugs allow for operation in most countries (See section 10).



With the power source (battery or AC) inserted into the Nova-Pro, turn the unit on by pressing and holding the POWER button  until the display illuminates, then release the button. To operate the unit, pull the trigger. The unit will remember the last mode used.

To turn the unit off press and hold the POWER button  until the display shows OFF and then release. The unit will automatically power off after 3 minutes.

3.1.1 Continuous Operation

The unit can be locked in continuous operation by pressing the POWER button  while squeezing the trigger. Keep holding the POWER button as you release the trigger and the Lock icon  will show on the display. To remove the lock simply pull the trigger.

3.2 Input / Output Connections

The Nova-Pro has input and output jacks on the side that can be used for external triggering or synchronization (daisy-chaining two or more strobes). These jacks accept 1/8" [3.5 mm] phone plugs (input-stereo, output-mono). The input jack provides a source of power (5Vdc @ 75mA) to power an external sensor and will accept a signal from 3 to 12 volts. The output is TTL compatible (3V) and provides a pulse synchronized to the internal generator (flash rate) or external input signal. Connection details are shown in Figures 3 and 4 below.



Figure 3 Input Connector Detail (Stereo plug)

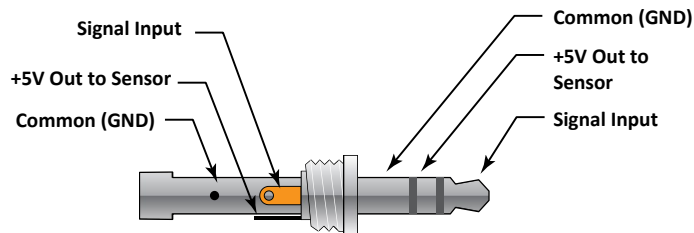
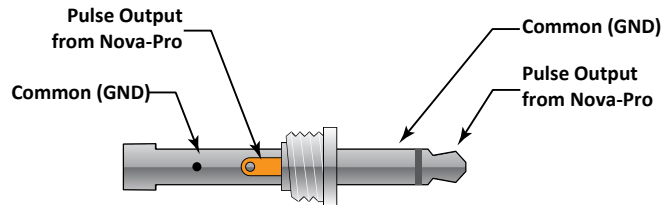

Figure 4 Output Connector Detail (Mono plug)



4. MODES OF OPERATION

The Nova-Pro has four modes of operation: **STROBE**, **LAMP**, **LASER** and **TACH** (Tachometer). Each are described in the sections below:

4.1 STROBE Mode

In this mode the strobe generates the flash rate from an internal generator set by the user. The strobe will not flash until the trigger is depressed. The strobe will output a pulse from the output jack at the rate of the internal setting whether the trigger is pressed or not. The user can set the flash rate using several methods.

4.1.1 Joystick

Pressing any button on the joystick will cause a digit on the display to start blinking—this is the digit that will be edited. There is a rollover effect when the digit is changed—if incrementing the units digit 99 will roll over to 100. If the user does not increment or decrement a digit within 5 seconds the edit mode will be cancelled.



Press ◀ or ▶ to change the digit that blinks

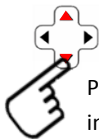

Press ▲ or ▼ to increase or decrease the value of the blinking digit. Hold for auto increment or decrement

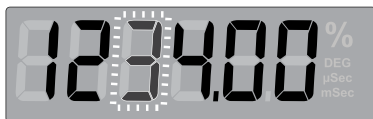

4.1.2 Touch Keypad Entry

Press the MENU button  to display the numeric keypad. The flash rate will default to 0 and show the units you are entering. Note that this is a capacitive touch sensitive keypad and will not respond if the user is wearing gloves.



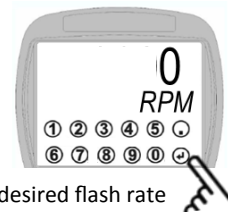

Press the MENU button



Enter the desired flash rate and press the ↵ enter key

4.1.3 Doubling or Halving the Flash Rate

Press the MENU button  twice to display the times 2 and divide by 2 icons. Press the POWER button  to exit this mode.



Press the MENU button twice

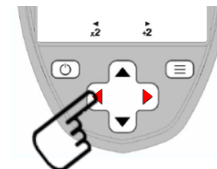

Use joystick or touch icons on display to x2 or ÷2

To confirm that the strobe is flashing at the same rate that the target is moving and that the RPM/RPS reading is accurate, use the X2 button until you see a double or multiple

image, then use the $\div 2$ button until you see a single image. This will now be the correct speed (see Figure 5).

Figure 5 Object rotating at 3000 RPM, using Flashes Per Minute (FPM) to determine speed

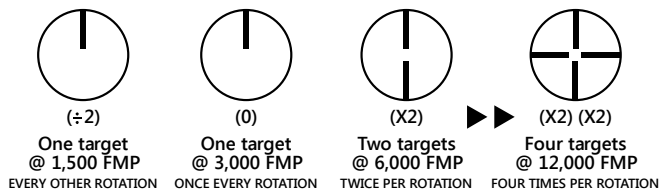

NOTE: If doubling or halving the flash rate causes the strobe to exceed its range, the display flash rate will remain at the current flash value.

4.1.4 External Input

Whenever an external source (sensor, signal generator or another strobe) is plugged into the input jack (➔ pointing towards jack) and the unit is in Strobe Mode, the signal from the external source becomes the source of trigger for the flash. The user cannot make any flash rate adjustments and the display will show the rate of the external input.

EXT External icon will show in display when there is an external sensor plugged into the strobe

Activating the trigger with a valid external input will cause the strobe to flash. If the external input is an optical sensor, activating the trigger will power the sensor. Aim the sensor at the target. Once the strobe has detected the target via the sensor on the rotating or reciprocating machine, the strobe will

flash each time a signal is received allowing the user to virtually “stop motion”. The speed read by the external sensor will be displayed in the selected units. The strobe can be configured to trigger on the positive or negative edge of the incoming pulse (MENU-MISC).

🕒 On-Target icon will show in display when a valid external signal is detected

Figure 6 Strobe with External Sensor

Monarch offers various types of external sensors that are compatible with the Nova-Pro including optical, laser, magnetic, inductive, etc. ROS-P shown.

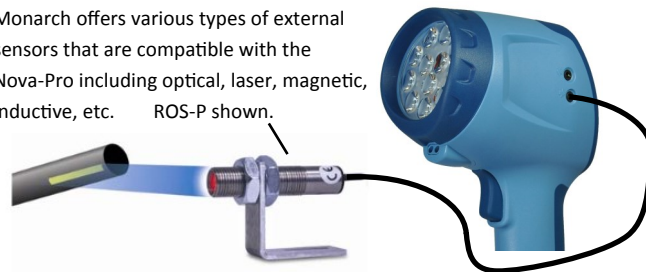

4.2 LAMP Mode

For full time activation of the UV light source, the Nova-Pro UV365/UV385 has a Lamp Mode that creates a bright, constant light for inspection. Be aware that this mode uses considerably more battery power, and that you should never look directly into the light source. The Nova-Pro has a temperature monitor for the LED lights, and will dim the lights if they become overly heated during extended use. A thermometer will appear on the display when this happens, and the Nova-Pro may go into shut-down mode if the LEDs get too hot.

4.3 LASER Mode

The Laser Mode is only available when the Laser Module is installed. This mode uses the LASER to trigger the strobe flash and is similar to the External Input Mode.

 Laser icon will blink when Laser Mode is enabled and be on solid when trigger is pulled and laser is on.

By pulling the trigger and aiming the laser at a reflective target on the rotating or reciprocating machine, the strobe will flash each time a reflection is received allowing the user to virtually “stop motion”.

 On-Target icon will show in display when target is detected by laser. The flash rate (speed) will be displayed in the selected units.

Figure 7 Using the Laser Module



CAUTION:

- AVOID EXPOSURE—LASER RADIATION IS EMITTED FROM THIS APERTURE
- AVOID DIRECT EXPOSURE TO BEAM
- DO NOT STARE DIRECTLY AT THE LASER SOURCE
- NEVER VIEW THROUGH OPTICAL INSTRUMENTS

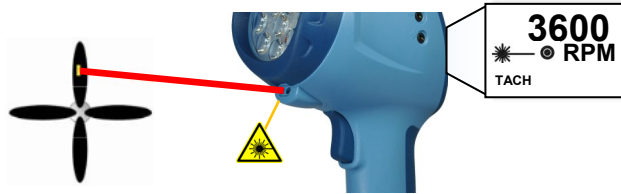
4.4 TACH (Tachometer) Mode

The TACH (Tachometer) Mode requires the Laser Module to be installed OR an external input (sensor) be plugged in. This mode uses the Laser or External signal to measure rotational speed.

TACH Tachometer icon will show in display when the Nova-Pro is in TACH Mode.

Unit will NOT FLASH in Tachometer Mode.

 Laser icon will blink when Laser Mode is enabled and be on solid when trigger is pulled and laser is on.

EXT External icon will show in display when there is an external sensor plugged into the Nova-Pro.

Pull the trigger and aim the laser (or external sensor) at a reflective target. The speed will be displayed in the selected units.



 On-Target icon will show in display when target is detected.

The TACH can be configured to trigger on the positive or negative edge of the incoming pulse from the external input (MENU-MISC).

Refer to Figure 7 Using the Laser Module and associated warnings.

5. MENUS

The menu that shows is dependent on the current operating mode of the unit and whether the Laser Module is installed.

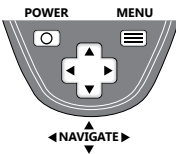
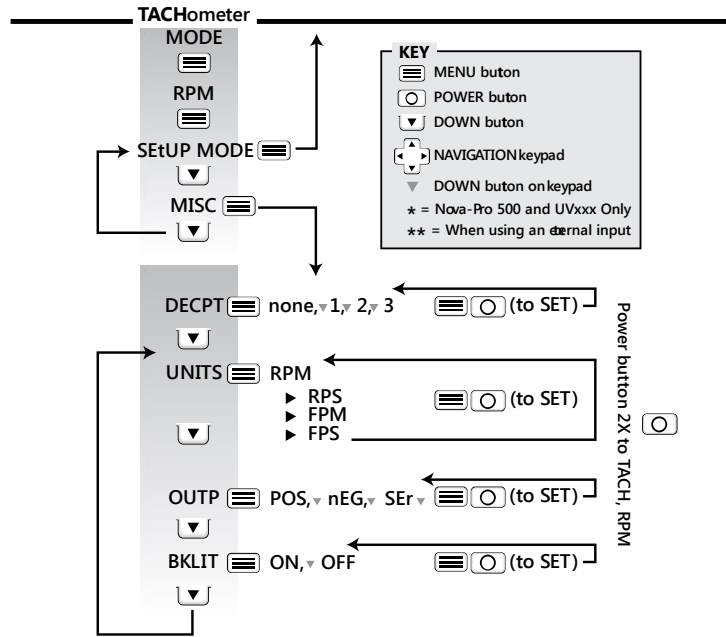

- UP ARROW (▲) will reverse direction through menu
- MENU button (≡) at any menu item will enter that item sub-menu.
- POWER button (⏻) will exit the current menu item

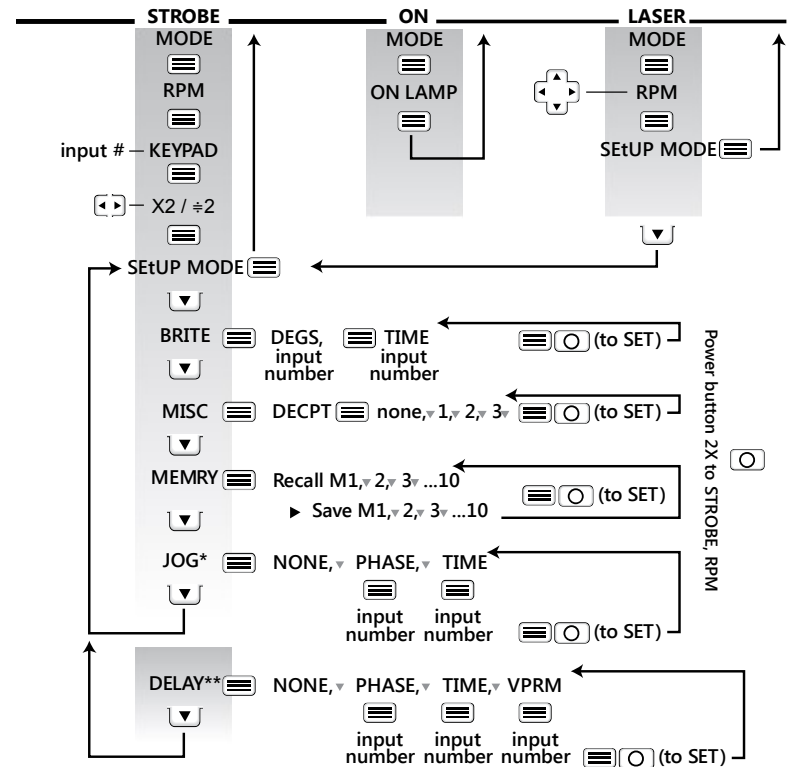

5.1 Menu Overview

To enter the menus, press the MENU  button once or three times depending on the current mode (see overview) until the word **SETUP** appears on the top line of the display. To select the current item shown on the lower line press the MENU button again. Not all items will be available in the menu; it depends on the operating mode.



Once in the Setup menu:



Use the ▲ and ▼ arrows on the joystick to scroll through the different available menu options.



Press the MENU button to enter menu options and make selections.





Press the POWER button to escape or back out of the menus.

On-Target icon will show which menu option is selected.

The following sections describe the individual submenus.

5.2 MODE Menu

MODE choices are: **Strobe**, **On** (Lamp) **tACH** (Tachometer), or **LASER** (if Laser Module installed).

Press the MENU  button to enter the MODE menu. The top line will show the mode and the On-Target  indicator will be on for the currently selected mode.



Use the ▲ and ▼ arrows on the joystick to select the desired mode.



Press the MENU button to select the desired mode. This will change the mode and exit the menu.



Press the POWER button to escape *without changing* the mode.

5.3 Brightness (BRITE) Menu

Refer to Section 8 for details on Brightness and Flash Duration before using this feature.

The Brightness (BRITE) menu option sets the flash duration which affects the brightness. Flash duration can be adjusted in degrees of rotation (proportional flash duration—changes with flash rate) or time in milliseconds (msec—fixed flash duration). The flash duration will be set by the last flash duration value adjusted. If you adjusted degrees, the strobe will have a flash duration in degrees proportional to the flash rate. If the adjustment was in time, the strobe will have a fixed duration irrespective of the flash rate.



This is a live adjustment—if the trigger is depressed, the effect of changing the brightness can be seen immediately.

5.3.1 Degrees

Press the MENU  button to enter the BRITE menu. The current flash duration will be shown in degrees.









Use the arrows on the joystick to adjust the flash duration in degrees - refer to section 5.1.1. Degrees can be set from 0.1° to 10°.

Press the MENU  button followed by the Power button  to save the degree setting.

5.4.3 INPUT Menu



This menu sets the pulse polarity of the external signal that will trigger the strobe. The options are **nEG** for negative edge or **POS** for positive edge.





Press the MENU  button to enter the INPUT menu. The current edge setting is shown on the top line with INPUT on the lower line. The On-Target  indicator will be on for the currently selected value.

-  Use the arrows on the joystick to select the desired value.
-  Press the MENU button followed by the Power  button to save the value.
-  To exit without changing the polarity press the Power button.

5.4.4 OUTP (OUTPUT) Menu

This menu sets the pulse polarity of the output signal that will trigger a device connected to the output jack. The options are **nEG** for negative edge or **POS** for positive edge.





Press the MENU  button to enter the OUTPUT menu. The current edge setting is shown on the top line with OUTP on the lower line. The On-Target  indicator will be on for the currently selected value.

-  Use the arrows on the joystick to select the desired value.
-  Press the MENU button followed by the Power  button to save the value.
-  To exit without changing the polarity press the Power button.

5.4.5 BKLIT (Backlight) Menu

This menu option turns the backlight of the display ON or OFF.

Press the MENU  button to enter the Backlight menu.

-  Use the arrows on the joystick to select the desired value. The backlight will change in real time.
-  Press the MENU button followed by the Power  button to save the value.
-  To exit without changing press the Power button .

5.5 Memory (MEMRY) Menu





The Memory (MEMRY) menu is used to store (save) or recall up to 10 different strobe settings. The settings that are saved and recalled are the flash rate and the brightness. All other settings on the unit remain the same.



Press the MENU button  to enter the MEMRY menu.

Use the right arrow  on the joystick to toggle between SM (Save Memory) or RM (Recall Memory).

5.5.1 Save Memory

To STORE the current strobe setting into a memory location:

-  Once in the Memory (MEMRY) menu, press the  arrow on the joystick to enter the Save Mode indicated by SM on the display. Use the  and  arrows on the joystick to select one of the memory locations in which to save the settings—SM1, SM2...SM10.



Press the MENU button  followed by the Power button  to save the current strobe setting into the displayed

5.3.2 Time

To set the flash duration in time instead of degrees, press the MENU  button again (skip the DEG menu).



Use the arrows on the joystick to adjust to the time value. Time can be set from 0.001 mSec to 1.000 mSec.

Press the MENU  button followed by the Power button  to save the time setting.

5.4 Miscellaneous (MISC) Menu

This menu item contains seldom used options. The miscellaneous items are: DECPT (Decimal Point), UNITS, INPUT, OUTP (Output) and BKLIT (Backlight).

Press the MENU  button to enter the MISC menu.



Use the ▲ and ▼ arrows on the joystick to scroll through the miscellaneous options.

 Press the MENU button to select the desired option.

 Press the POWER button to exit/escape.



5.4.1 DECPT (Decimal Point) Menu

The Decimal Point menu adjusts the resolution of the Flash/Tach rate displayed. Up to three places after the decimal point can be shown. The number of decimal places is limited by the 6-digits available and the unit will auto range to show the maximum number of digits after the decimal point selected by the user. The choices are NONE, 1, 2, 3. A value of 600 will be displayed as 600, 600.0, 600.00, 600.000 depending on the setting.

Press the MENU  button to enter the DECPT menu. The current value is shown on the top line with DECPT on the lower line. The On-Target  indicator will be on for the currently selected value.



Use the arrows on the joystick to select the desired value.

 Press the MENU button followed by the Power button  to save the decimal point setting.

 To exit without setting the decimal point press the Power button.

5.4.2 UNITS Menu



This menu option selects the Engineering Units used to display the flash rate or speed. The choices are:

- FPM - Flashes per Minute (Not available in TACH Mode)
- FPS - Flashes per Second (same as Hz, not available in TACH Mode)
- RPM - Revolutions per Minute
- RPS - Revolutions per Second (same as Hz)

Press the MENU  button to enter the UNITS menu. Unit is shown on the top line with the current engineering unit on the lower line. The On-Target indicator will be on for the currently selected value.



Use the arrows on the joystick to select the desired value.

 Press the MENU button followed by the Power  button to save the value.

 To exit without setting the units press the Power button.





location. The current flash rate will then be shown in that location.

To exit without saving a value press the POWER button .

5.5.2 Recall Memory

To **RECALL** a saved strobe setting:



 Once in the Memory (MEMRY) menu, make sure the you are in the Recall Mode as indicated by RM on the display. Use the ▲ and ▼ arrows on the joystick to select one of the memory locations from which to load the settings—RM1, RM2...RM10.

 Press the MENU button followed by the Power  button to recall the setting from the selected location.

 To exit without recalling a memory location press the Power button .

5.6 JOG Menu

This menu option is only valid in the **STROBE Mode** with **NO External Input**. Refer to Section 7 for details on DELAY before using this menu item. All delays are relative to the current flash rate.

Press the MENU  button to enter the JOG menu. The current setting will be shown and the On-Target  indicator will be on for the currently selected value.

 Use the arrows on the joystick to select the desired Jog method. The options are: NONE, PHASE, and TIME.

Press the MENU  button to select a Jog method. This will enter the sub-menu for PHASE or TIME.

5.6.1 NONE

To cancel the JOG mode, press the MENU  button when NONE is displayed.

5.6.2 PHASE

To Jog by PHASE, press the MENU  button when PHASE is displayed.

The phase value will be shown in degrees. Use the joystick to set the desired value (refer to section 5.1.1). Phase can be set from -360.0° to +345.0°.

Press the MENU  button to accept and exit.

5.6.3 TIME

To Jog by TIME, press the MENU  button when TIME is displayed.



The time value will be shown in milliseconds. Use the joystick to set the desired value (refer to section 5.1.1). Time can be set from -50.000 mSec to +50.000 mSec.

Press the MENU  button to accept and exit.

To exit the JOG Menu, press the Power button  .

5.7 DELAY Menu

This menu option is only valid in the **STROBE Mode** with an **External Input** or in the **Laser Mode**. Refer to Section 7 for details on DELAY before using this menu item. All delays are relative to an external trigger which may be derived from the internal laser or external input.

Press the MENU  button to enter the DELAY menu. The current setting will be shown and the On-Target indicator  will be on for the currently selected value.

 Use the arrows on the joystick to select the desired Jog method. The options are: NONE, PHASE, and TIME.

Press the MENU button  to select a Delay method. This will enter the sub-menu for PHASE, TIME or VRPM.

5.7.1 NONE

To cancel the DELAY mode, press the MENU button  when NONE is displayed.

5.7.2 PHASE

To Delay by PHASE, press the MENU button  when PHASE is displayed.

This method of delay is set the same as PHASE in JOG. NOTE: The adjustments happen in **real time**, so if the strobe is flashing the user can view the effect of changing the delay.

5.7.3 TIME

To Delay by TIME, press the MENU button  when TIME is displayed.

This method of delay is set the same as TIME in JOG. NOTE: The adjustments happen in **real time**, so if the strobe is flashing the user can view the effect of changing the delay.

5.7.4 VRPM

Virtual RPM (VRPM) is an AUTO delay mode. To set VRPM, press the MENU button  when VRPM is displayed.

The virtual RPM value will be shown. Use the joystick to set the

desired value (refer to section 5.1.1). VRPM can be set from -60.0 RPM to +60.0 RPM.

Press the MENU button  accept and exit. NOTE: The adjustments happen in **real time**, so if the strobe is flashing the user can view the effect of changing the RPM.

To exit the DELAY Menu, press the Power button  .

Press the Power button  to escape back out of the setup menu.

6. STROBE BRIGHTNESS

The strobe's brightness depends on how wide the strobe's flash pulse is; the wider the pulse, the brighter the flash from the LEDs appears to be. There is however, a downside to the wider pulses. All strobes work by giving short bursts of light (the pulse width) at a rapid repetition rate (the flash rate). Strobes rely on the persistence of the human eye (the ability to remember and image) and its response to bright light to give an apparent stop motion image. Imagine a shaft rotating at 6000 RPM or one rotation every 1/100 of a second (10 msec). If the strobe flashes once every 10 msec for a brief moment, the user sees the flash at the same spot in the rotation of the shaft and the persistence of the eye remembers this until the next flash making the shaft appeared to be stopped. As the target is rotating there is some movement evident during the strobe flash. The longer the flash duration, the more obvious the rotation is and this increases the blur. The Lamp ON Mode does not have a brightness setting.

6.1 Calculating Blur

Blur can be calculated— if the shaft is turning at 6000 RPM, it takes 10 msec to complete one revolution. If the strobe flash duration is 100 µsec (1/100 of a millisecond), the shaft will turn:

(flash duration/time per rotation) x 360°, which is (.0001/.01) x 360 = 3.6°. So you will see the shaft appear to move 3.6°.

As the flash pulse widens you will see greater degrees of rotation which results in more blur and a brighter perceived illumination (the LEDs are on longer so the average light the eyes see is greater). The trade off is blur versus brightness. The further away the rotating point is from the center axis the faster the tangential velocity and the worse the blur appears to be.

When setting the pulse duration in degrees, what you set is what you get. Refer to the image on the right for the difference between a 1° and 5° (of rotation) flash duration.

There are two methods of adjusting the flash pulse width and hence the brightness and consequently the blur. For setting Brightness see Brightness (BRITE) Menu.

6.2 Brightness in Degrees of Rotation

Brightness can be set from 0.2 to 14 degrees out of 360. The higher the setting the brighter the strobe appears to be but the more blurred the target is. Optimal setting to stop motion is 1.8 to 3.6°. The number of degrees is a proportional amount and remains constant as the flash rate increases or decreases. The strobe automatically calculates how wide the pulse width should be at different flash rates to keep the blur constant*—the faster the flash rate the narrower the pulse width. The pulse width equals: (setting in degrees/360) x (1/flashrate in Hz).

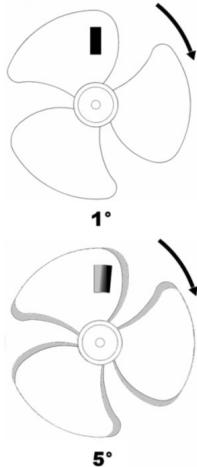

6.3 Brightness in Pulse Duration

Brightness can also be set to a fixed duration pulse in microseconds. The flash rate remains constant irrespective of the flash rate, thus as the flash rate increases, the image will get brighter and more blurred.

Note: There are two limits maintained by the strobe – the flash pulse width can never be greater than 2.0 msec (milliseconds) nor can it exceed 14° of rotation.

The strobe automatically adjusts the pulse width and rotation values as the flash rate is increased or decreased to maintain the limits at all times. For example—a flash rate of 600 flashes per minute (10 Hz), 14° of rotation represents a flash pulse width of 3.8 msec. The strobe will limit this value to 2.0 msec or 7.3° of rotation (blur).

7. STROBE DELAY

The Nova-Pro UV has multiple special effects that can be used to inspect moving machinery in different ways. The Delay effects depend on whether a Laser Module is installed and the Mode of Operation. Delay, or Phase Shifting, allows the user to view different positions of the rotating machinery relative to a virtual or fixed trigger point (via External sensor or internal Laser).

7.1 Internal Phase Delay

In the internal STROBE Mode the Delay is relative and no external trigger is used. This is referred to as JOG. Once the flash rate has been adjusted to give a stopped motion image, the JOG buttons (◀ and ▶ icons on the touchpad) may be used to increase or decrease the phase of the image with respect to its original position by the amount set in the JOG Menu.

Use this feature to bring a reference mark, such as a keyway, into your line of sight. It may be necessary to adjust the flash rate to keep the target static if the speed is drifting.

Use the JOG Menu to set a PHASE Delay of -30° . The display will show PHASE with the left and right arrow icons. Use the joystick to adjust the flash rate to stop motion of the rotating object. Then use the ◀ and ▶ icon touch buttons to move the phase of the objects as shown in Figure 8.

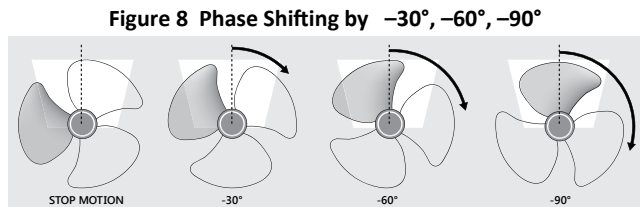

Figure 8 Phase Shifting by -30° , -60° , -90°

7.2 External / Laser Delay

There are three External Delay Modes: **Phase Delay**, **Time Delay** and **Auto (Virtual RPM)**. These modes are only active if an external trigger source is available via the internal Laser Module or an external sensor.

7.2.1 Phase Delay

In the External Phase Delay Mode the flash is delayed from the external trigger by the number of degrees set in the DELAY PHASE menu ($+345.0^\circ$ to -360.0°). One revolution is 360° . The display will show the **PHASE** icon to indicate the delay mode. See Figure 9 for examples of the effect of setting various PHASE delays with respect to the trigger point.

Figure 9 Triggered Phase

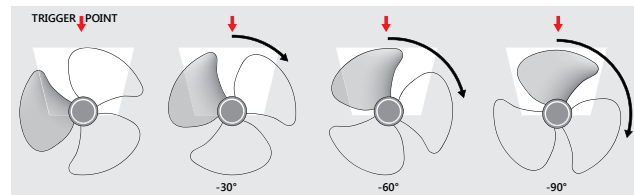

The Phase Delay tracks the speed of the target; the strobe is continuously computing the delay angle for the current speed. In the Menu, the adjustments happen in **real time**, so if the strobe is flashing the user can view the effect of changing the display.

7.2.2 Time Delay

In the External Time Delay mode the flash is delayed from the external trigger by the time in milliseconds (msec) set in the DELAY TIME menu (-50.000 to $+50.000$ msec). The TIME Delay is absolute and remains constant irrespective of the speed of the target. The display will show the **TIME** icon to indicate the Delay Mode. The effect is similar to Figure 9 above but the delay will be in the millisecond setting in the TIME Menu. In the Menu, the adjustments happen in **real time**, so if the strobe is flashing the user can view the effect of changing the delay.

7.2.3 AUTO - Virtual RPM

In the AUTO (Virtual RPM—VRPM) mode the flash is automatically delayed in increasing or decreasing amounts after the external trigger pulse so that the image appears to rotate at a slow speed (Virtual RPM) as set in the VRPM menu

(0 to 60 RPM). This gives a “slow-motion” effect and enables the target to be examined as it moves through a complete cycle or revolution. The display will show the **AUTO** icon to indicate the Delay Mode with the virtual speed in RPM on the top line and will indicate VRPM (Virtual RPM) on the lower line. In the Menu, the adjustments happen in **real time**, so if the strobe is flashing the user can view the effect of changing the virtual RPM.

NOTE: Turning the power off will reset the delay modes.

8. BATTERY PACK

When ordered as such, the Nova-Pro comes with one two rechargeable Lithium Ion battery pack(s), external charger and power supply. The Battery Pack is shipped in a mostly discharged state and has tape over the terminals.



**REMOVE TAPE BEFORE USE.
CHARGE BATTERY PRIOR TO USE.**

CAUTION:

- Do not store battery in hot locations.
- Do not expose to fire.
- Do not disassemble.
- Do not apply mechanical force.

REMOVE Battery Pack from unit before storing for long periods.

DO NOT DISPOSE of the Lithium-Ion batteries as unsorted municipal waste. The batteries need to be **RECYCLED** in accordance with local regulations. The batteries should be sent to a recycling center or returned to the factory using appropriate shipping methods.

The Nova-Pro Battery Pack is specifically keyed to fit in the Nova-Pro and Charger Base one way only. Insert the Battery Pack into the Nova-Pro until the clips lock into place. To remove, squeeze clips on the Battery Pack to release from the Nova-Pro.

8.1 Low Battery Functionality

 Low battery icon will blink when battery pack needs to be recharged. The unit may still be used for a short time.

The Nova-Pro will display “LOBAT” and shut down when the battery pack is exhausted and must be recharged.

8.2 Charging the Battery Pack

The Nova-Pro Battery Pack must be removed from the Nova-Pro to be charged using the Nova-Pro Charging Station and power supply provided.

CAUTION: Never attempt to charge the Battery Pack with anything other than the Charging Station and power supply provided with the Nova-Pro.

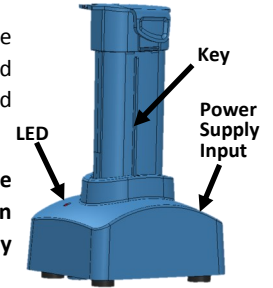

The Nova-Pro Charging Station has an light emitting diode (LED) that indicates the state of the battery/station. The LED indicates the following:

| | |
|--------------|------------------------------------|
| Green | On / No Battery or Battery Charged |
| Red | Charging |
| Flashing Red | Error / Replace Battery |

Battery charge time will be up to 6 hours depending on Battery Pack and residual charge. Once the battery is charged the charger will switch to trickle charge mode—the battery should be removed once the charge LED turns green.

9. AC POWER OPTION

The Nova-Pro can be ordered specifically with the AC Power Option for continuous operation from AC power. The AC Power Option can also be ordered as a separate option for the Nova-Pro. Simply insert the AC Power Option into the Nova-Pro (matching the keyed slot) until it clicks into place. Then plug the wall power supply into an outlet (115Vac to 230Vac) using the appropriate interchangeable plug.

10. WALL POWER SUPPLIES



The wall power supplies provided with the Nova-Pro have interchangeable plugs allowing them to be used with AC outlets in different countries.

To change the plugs, depress the button (1) and slide the plug up (2). Select the correct plug and slide it back into the power supply until the plug seats firmly. Make sure the plug cannot slide out.

CAUTION: RISK OF ELECTRIC SHOCK

- Do not insert the plugs into an AC outlet without the power supply attached.
- Avoid touching the plugs when inserting or removing the power supply from the AC outlet.
- Indoor Use Only.



11. SPECIFICATIONS

| Specifications | Nova-Pro UV 385 nm |
|----------------------------|-------------------------------------------------------------------------------------------------------------------------------------------------------|
| Flash Range (FPM/RPM): | 30 to 999,999 |
| Display: | 6 digit numeric and 5 digit alphanumeric LCD with touch keypad. High contrast blue background/white characters with backlight |
| Accuracy/Resolution: | 0.001% of setting or ± 1 lsd/6 digits to 0.001 |
| Light Source: | UV 365 nm or UV 385 nm 12 LED Array |
| Light output: | 1700 μ w/cm ² @ 12", 1% duty cycle |
| Flash Duration: | Adjustable to 10 degrees/2.000 msecs max |
| External Triggers in/out: | TTL (12Vdc Max) Input. Provides 3.3 Vdc TTL output |
| Tachometer Mode: | 0-999,999 RPM with integral laser or external input |
| Programmable Memory: | Yes (10 set points) |
| Internal Phase Shift: | Yes |
| Phase Delay - degrees: | -360.0 to 345.0 degrees |
| Time Delay - milliseconds: | -50.000 to 50.000 msec |
| Virtual RPM (Slow Motion): | -60.0 to 60.0 VRPM |
| Operating Time: | Standard battery pack: 9.5 hours typical (6000 FPM, 2" duty cycle) Hi-capacity battery pack (optional): 19 hours typical (6000 FPM, 2" duty cycle) |
| Power Supply (Battery): | Removable/rechargeable Standard Li-Ion battery packs (Qty. 2) with 115/230 50/60Hz recharging station |
| Power Supply (A/C): | 115/230 Vac 50/60Hz AC adapter with 6 foot (2M) cable and interchangeable outlet adapters (Optional) |
| Weight: | 1.4 Lbs. (635 grams) |
| Size (H x W x D): | 9.5 x 3.75 x 5.5 in. (241 x 95 x 140mm) |
| Housing material/rating: | ABS/IP54 |

Product specifications are subject to change without notice.

11.1 Operating Environment

This equipment is NOT intended for permanent installation.

This equipment is for use in a controlled environment -
Environmental situation A, Pollution Degree 2.

Altitude: up to 2000 m

Temperature: 5 °C to 40 °C

Humidity: Maximum relative humidity 80% for temperatures
up to 31 °C decreasing linearly to 50% relative humidity
at 40 °C.

Rating: Splash proof—IP 54

Category: 2

11.2 Compliance

11.2.1 Batteries

The Lithium-Ion battery packs used in this product meet the requirements of **UN DOT 38.3**.

Tested by Shenzhen SEM. Test Technology Co. Ltd.
(Reports STR16079052S/54S)

11.2.2 California Energy

Title 20 Blah, blah

11.2.3 EU Declaration of Conformity

Please visit our website www.monarchinstrument.com to
download our EU Declaration of Conformity for this product.

12. OPTIONS, ACCESSORIES and SENSORS

Laser Module Dock Optional docking station for Laser Module which can be removed from the Nova-Pro to be used as an external laser sensor. Comes with blanking panel for Nova-Pro.

| | |
|-------------------------------|--------------------------------------------------------------------------------------------------------------------------------------------------|
| AC Adapter | Replacement/optional 115/230 Vac 50/60 Hz AC Adapter with 6 foot [2M] cable with USA, UK, AUS, Euro adapter plugs. |
| Charging Station | Replacement Charging Station for Nova-Pro Li-Ion Battery Packs. Includes 115/230 Vac power supply with USA, UK, AUS, Euro adapter plugs. |
| Charger Power Supply | Replacement power supply for use with Charging Station: 115/230 Vac with USA, UK, AUS, Euro adapter plugs. |
| Standard Battery Pack | Replacement Standard Li-Ion Battery Pack. |
| Long Life Battery Pack | Optional Long Life Li-Ion Battery Pack. |
| CC-15 | Latching carrying case for Nova-Pro with provision for accessories. |
| CC-16 | Deluxe water-tight latching carrying case for Nova-Pro with provision for accessories (included in Nova Pro Kit model). |
| C-4027 | Set of mating 1/8 inch (3.5mm) stereo phone plugs (to provide TTL signal and sensor power). |
| CA-4044-6 | 6 foot [1.8 m] Input / Output cable, 1/8 inch [3.5 mm] male phone plug to male BNC connector. |
| CA-4045-6 | 6 foot [1.8 m] Input / Output cable, 1/8 inch [3.5 mm] male phone plug to 1/8 inch [3.5 mm] male phone plug for daisy chaining strobes together. |
| ROLS-P | Remote Optical Laser Sensor with 8 foot [2.5 m] cable for triggering strobe. |
| ROS-P | Remote Optical Laser Sensor with 8 foot [2.5 m] cable for triggering strobe. |
| ROS-P-25 | Remote Optical Sensor with 25 foot [7.6 m] cable for triggering strobe. |
| IRS-P | Infrared Sensor with 8 foot [2.5 m] cable for use without reflective target at 0.5 inch [12 mm] gap for triggering strobe |
| MT-190P | Magnetic Trigger Sensor/Amplifier with 8 foot [2.5 m] cable for triggering strobe. |
| T-5 | Reflective tape - 5 foot [1.5 m] roll, 0.5 inch [12.7 mm] wide. |
| CAL-N.I.S.T | N.I.S.T. Traceable Certificate of Calibration / Recalibration. |

Check out our other product lines...



**Handheld
Tachometers**



**Panel
Tachometers**



**Portable
Stroboscopes**



**Machine Vision
Stroboscopes**



Speed Sensors



**Temperature/
Humidity Sensors**



Vibration Meters

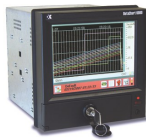

Paperless Recorders



Track-It® Data Loggers

Printed in the U.S.A.

© Copyright 2017 Monarch Instrument, all rights reserved

1071-42483-110 rev 1.0