



DET2/3

Advanced Earth (Ground) Tester

User Guide

Contents

Safety	1
Safety warnings	1
Live earth safety precautions	2
Voltage measurement categories	2
CAT IV	2
CAT III	2
CAT II	2
Test leads and clamps	2
Safety and hazard icons	3
Warning Icons	3
Warnings, Cautions and Notes	3
Warnings	3
Cautions	3
Notes	3
Introduction	4
Applications	4
Agricultural location	4
Features	4
Accessories	4
Overview	5
User interface	5
Display	6
Controls	7
Navigation control panel	8
Terminals	8
Soft keys	9
Operation	10
Power on / off	10
Auto off	10
Power options	10
Earth test options	10
Output voltage	10
Test frequency	10
Noise filter	10
Test leads and terminal connections	11
Test modes	11
Manual mode	11
Continuous graphical mode	11

Set-up	12
Modify parameters.....	12
General set-up.....	12
Graph set-up.....	13
Language set-up.....	13
Earth / ground resistance	14
Test procedure.....	14
Earth / ground resistivity	17
Test procedure.....	17
Continuity Test	20
Test procedure.....	20
Null test leads.....	21
Leakage Current Test	22
Test procedure.....	22
See Data management (page 33).....	22
Test methods and set-up	23
Fall of potential (FoP) test.....	23
Four terminal test lead set-up.....	23
Four terminal ART test lead set-up.....	24
Three terminal test lead set-up.....	24
Three terminal ART test lead set-up.....	25
Slope method (FoP).....	25
Description.....	25
Slope four terminal test lead set-up.....	28
Slope three terminal test lead set-up.....	28
61.8% Rule (FoP).....	29
61.8% Four terminal test lead set-up.....	29
61.8% Three terminal test lead set-up.....	29
Two terminal earth resistance test.....	30
Two clamp (stakeless) test.....	30
Calibration check tools	31
Instrument calibration check.....	31
Checking instrument accuracy.....	31
Clamp calibration check.....	32
Data management	33
Save test result.....	33
To edit a record file name as... ..	33
USB connection.....	34
Single test result: download or delete.....	35
Multiple test results: download or delete.....	35

Maintenance	36
General maintenance.....	36
Cleaning.....	36
Battery.....	36
Battery status.....	36
Battery replacement.....	37
Battery charge	38
12 V supply	38
Specifications	39
Measurement specifications.....	39
Instrument specifications.....	40
Instrument calibration check tool.....	40
Electrical specification	40
Mechanical specification	40
Clamp calibration check tool.....	41
Electrical specification	41
Mechanical specification	41
Accessories	42
Repair and warranty	43
Calibration and repair	44
Return procedure.....	44
Approved service centres	45
End of life	46
WEEE directive	46
Battery disposal	46
Declaration of conformity	47
Bibliography	48
Notes	49

Safety

The safety warnings given in this document are indicative of safe practice and shall not be considered exhaustive. Additionally, they are not intended to replace local safety procedures where the instrument is used.

Note: This User Guide uses the term 'earth' throughout some market areas may use the term 'ground'.

Safety warnings

These safety warnings must be read and understood before the instrument is used. Retain for future reference.

Caution: The instrument must be operated only by suitably trained and competent persons.

- If this instrument is used in a manner not specified by the manufacturer the protection of the instrument may be impaired.
- The instrument must NOT be used if any part of it is damaged.
- Damaged test leads must NOT be used. Periodically inspect all test leads. Cables and connectors must be in good order, clean and have no broken or cracked insulation. Users must exercise caution when connecting to and disconnecting from the system under test. Do not touch any part that could be hazardous live.
- Make sure that there are no hazardous voltages before connecting the instrument. Special precautions are required when working with an untested and possibly 'live' earth. Isolation switches and fuses (not supplied) must be used.
- The instrument will indicate the presence of hazardous voltage between the P terminals. In the absence of an indication do not assume that there are no hazardous voltages.
- Do not touch the test leads or any conductive parts in the test circuit while a test is in progress.
- Do not leave the instrument unattended when connected to the system under test and always disconnect the instrument after tests have been completed.
- The only clamps certified for use with the DET2/3 are the Megger MCC1010 and MVC1010, no other clamps are to be used with this instrument. It is unsafe to use any other clamps.
- This instrument contains a lithium-ion high energy battery pack.
 - Do not pierce, damage, disassemble or modify the battery. The battery contains safety and protection devices, which if tampered with may cause the battery to generate heat, rupture or ignite.
 - If a battery is suspected to be faulty, replace it with a Megger approved battery pack. Refer to the User Guide for instructions on how to change the battery.
 - If an instrument is suspected to contain a faulty battery, the battery must be removed before the instrument is shipped.
 - Do not ship a faulty battery, either separately or inside an instrument.
 - The instrument must be set to OFF and the lid must be installed and securely closed before the instrument is shipped.
 - Do not heat or dispose of the battery in a fire.
 - Do not subject the battery to strong impact, mechanical shock or excessive heat.
 - Do not short-circuit or reverse the polarity of the battery pack.

Users of this equipment and their employers are required by Health and Safety Legislation to carry out valid risk assessments of all electrical work so as to identify potential sources of electrical danger and risk of electrical injury such as inadvertent short circuits. Where the assessments show that the risk is significant then the use of fused test leads may be appropriate.

Live earth safety precautions

A 'Live' earth is one that carries current from the mains supply, or could do so under fault conditions. The following warnings apply in addition to those listed previously:

- All persons involved must be trained and competent in isolation and safety procedures for the system to be worked on. They must be clearly instructed not to touch the earth electrode, test stakes, test leads, or their terminations, if any 'live' earths may be encountered. It is recommended that they wear appropriate rubber gloves, rubber soled shoes, and stand on a rubber mat
- The earth electrode under test should be isolated from the circuit it protects before a test is started. If this is not possible, ART may be used to measure electrode resistance
- The instrument terminals should be connected to the system under test through isolation switches. The isolation switches must be rated to handle the likely maximum fault voltages and currents that could be encountered at the installation.
- The isolation switch must be open when any physical contact is made with the remote test stakes, or the connecting leads, for example, when changing their position
- The instrument terminals should be connected to the system under test through fuses, that are rated to handle the likely maximum fault voltages and currents that could be encountered at the installation

Voltage measurement categories

The rated measurement connection voltage is the maximum line to earth voltage at which it is safe to connect.

CAT IV

Measurement Category IV: Equipment connected between the origin of the low-voltage Mains supply and the Distribution Panel.

CAT III

Measurement Category III: Equipment connected between the Distribution Panel and the electrical outlets.

CAT II

Measurement Category II: Equipment connected between the electrical outlets and the User's equipment.

Measurement equipment may be safely connected to circuits at the marked rating or lower. The connection rating is that of the lowest rated component in the measurement circuit.

Test leads and clamps





Megger supply test leads designed for the DET2/3 which are rated correctly for the test voltage generated by this instrument, but not all are rated for mains connection. Users must select the correct leads for their project, this will be either low voltage type rated 50 V, 1 A or leads designed for mains environment rated at 300 V.

Caution: Measurement leads connected to this instrument must be rated at least 50 V, 1 A.

The terminals for connecting current and voltage clamps are not isolated from the measurement terminals. If the DET2/3 is used in a CAT IV 300 V environment, the clamps and their measurement leads must be rated the same or higher. Only the Megger MCC1010 and Megger MVC1010 are sufficiently rated, no other clamps are to be used.



Safety and hazard icons

This section details the various safety and hazard icons on the instruments outer case.

Icon	Description
	Warning: High Voltage, risk of electric shock
	Caution: Refer to User Guide
	Equipment complies with current EU directives
	Equipment complies with current 'C tick' requirements
	Do not dispose of in the normal waste stream

Warning Icons

This section details the warning icons that can show on the display.

Icon	Warning	Description
	External Voltage Warning	<p>If an external voltage is applied between the terminals and the instrument is set to On, the high voltage warning will flash to say that the item under test is live and might be dangerous and the test is disabled.</p> <p>The high voltage warning message will flash if more than 30 V potential difference is applied between the voltage terminals and the current terminals.</p> <p>This warning will not show if all terminals are at the same high voltage.</p> <p>Note: The warning will not operate if the instrument is set to Off.</p>
	Internal Error Warning	Internal Error Warning switch off and back on. Contact Megger if not cleared.
	Read the User Guide	Refer to the user guide if this message shows.

Warnings, Cautions and Notes

Warnings

Warnings alerts the reader to situations where a hazard to personnel can occur. They are placed before the event to which they relate and are repeated at each applicable occasion.

Cautions

Cautions alerts the reader to situations where equipment damage may result if a process is not followed. They are placed before the event to which they relate and are repeated at each applicable occasion.

Notes

Notes give additional information that aid the reader in the use or understanding of the equipment or subject, they are not used when a Warning or Caution is applicable.

They are not safety related and may be placed either before or after the associated text as required.

Introduction

This user guide details the operational and functional details of the DET2/3 advanced earth (ground) tester.

Please read this user guide fully before attempting to use the DET2/3.

The DET2/3 automatic earth test instrument is designed to measure earth Electrode Resistance and Soil Resistivity, with highly accurate results. It is powered by an internal rechargeable battery which has a long usage period. The battery is recharged with an external power supply unit.

Please refer to the image opposite on page 5 for detail of the DET2/3 layout.

For personal safety and to get the maximum benefit from this instrument, make sure that the safety warnings and instructions (Safety (page 1)) are read and understood before the instrument is used.

The list of tests and connections detailed in this user guide are not exhaustive. Refer to the booklet **Getting Down To Earth** for more information.

Applications

The DET2/3 can be used on large or more complex earth systems, which include communications earth systems and difficult test environments. It can be used to test in accordance with BS 7430 (Earthing), BS-EN-62305 (Lightning Protection), BS-EN-50122-1 (Railway Applications) and IEEE Standard 81.

Soil resistivity measurements are used to establish the optimum electrode design and site, as well as performing archaeological and geological investigations.

Where there is doubt about a particular application, reference should be made to the advice and guidance contained in the publication **Getting Down to Earth**.

Agricultural location.

The DET2/3 can be used in agricultural locations (as per IEC 61557-5) where, to comply with the standard, the output voltage must be set to 15 V.

It can also set to 15 V when risk assessment determines that a 50 V test voltage is too high.

Note: IEC 61557-5 recommends that the output is below 25 V in agricultural locations.

Features

The DET2/3 provides accurate 1 mΩ resolution measurements of earth Electrode Resistance.

With its microprocessor controlled system it provides a flexible user-friendly approach to earth tests by the provision of excellent error detection capabilities and full test information shown on a large colour display.

Test frequency, test voltage and filtering can be quickly and easily adjusted so that adverse conditions, which can influence the test, can be overcome.

Resistance measurements can also be made with a switched dc signal at a variable frequency of between 10 Hz and 200 Hz.

A wide band of test current frequencies, with a resolution of 0.5 Hz, can be used to eliminate errors caused by noise in the earth.

The DET2/3 also includes an automatic frequency selection feature that scans for frequencies with the lowest noise level and then runs a test at that frequency.

Accessories

A large range of accessories are available, contact Megger for details (Refer to page 42).

Overview

User interface



No.	Description	No.	Description
1	External power / battery charge socket	6	Function switch (Controls (page 7))
2	Display	7	Navigation control panel (page 8)
3	USB: 1x Type A / 1x Type B	8	Mode switch (Controls (page 7))
4	Soft keys (page 9)	9	Save (Test Result Management (page 36))
5	Terminals (page 8)	10	External power LED (Power on / Charge (page 10))

Display

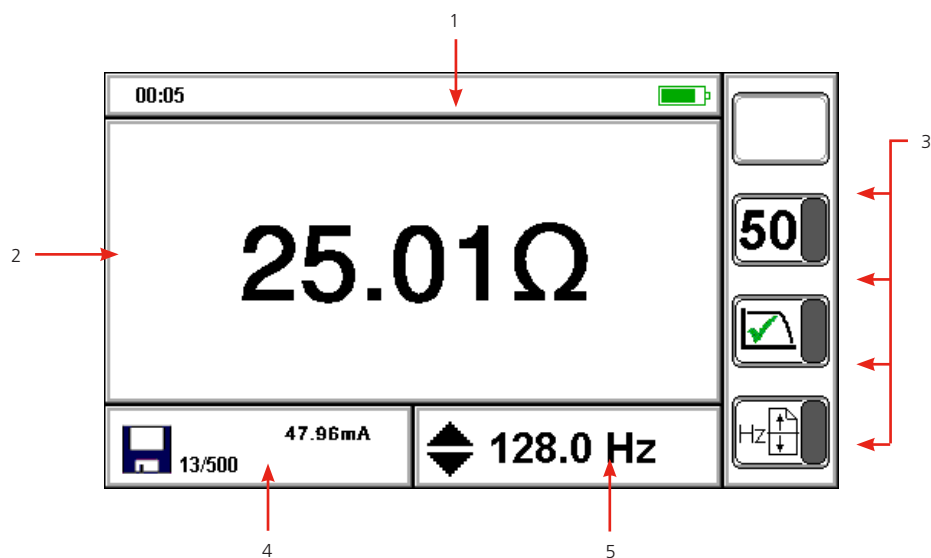

No.	Description	No.	Description
1	Status bar	4	Test mode: Secondary measurement result Data management mode: Asset number
2	Main display / Primary measurement result	5	Test mode: Test parameters Data management mode: Record name
3	Soft key functions		

Controls

Refer to user interface (page 5).

Mode switch

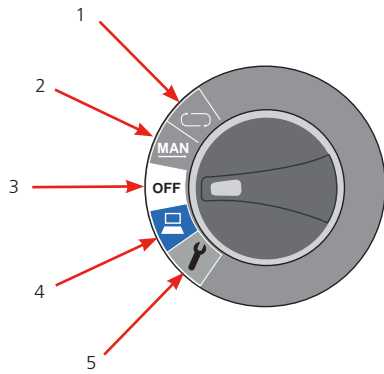

Function switch

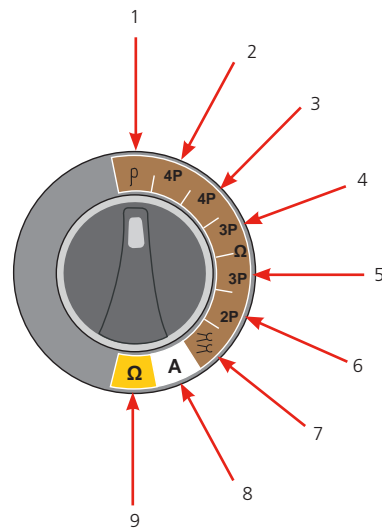

No.	Description	No.	Description
1	Continuous graphical mode (page 11)	1	ρ (Resistivity)
2	Manual mode (page 11)	2	4 Pole (ART)
3	Power on / off (page 10)	3	4 Pole
4	Test result management (page 33)	4	3 Pole (ART)
5	Set-up (page 12)	5	3 Pole
		6	2 Pole
		7	Dual clamp
		8	A (leakage current)
		9	Ω (continuity)
			See Test methods and set-up (page 23).

Navigation control panel

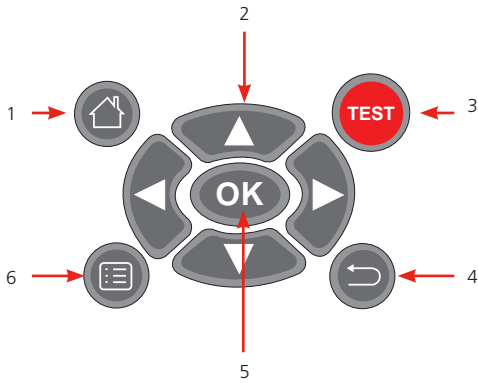

No.	Description	No.	Description
1	Home	4	Back
2	Navigation arrows	5	OK
3	Test	6	Menu





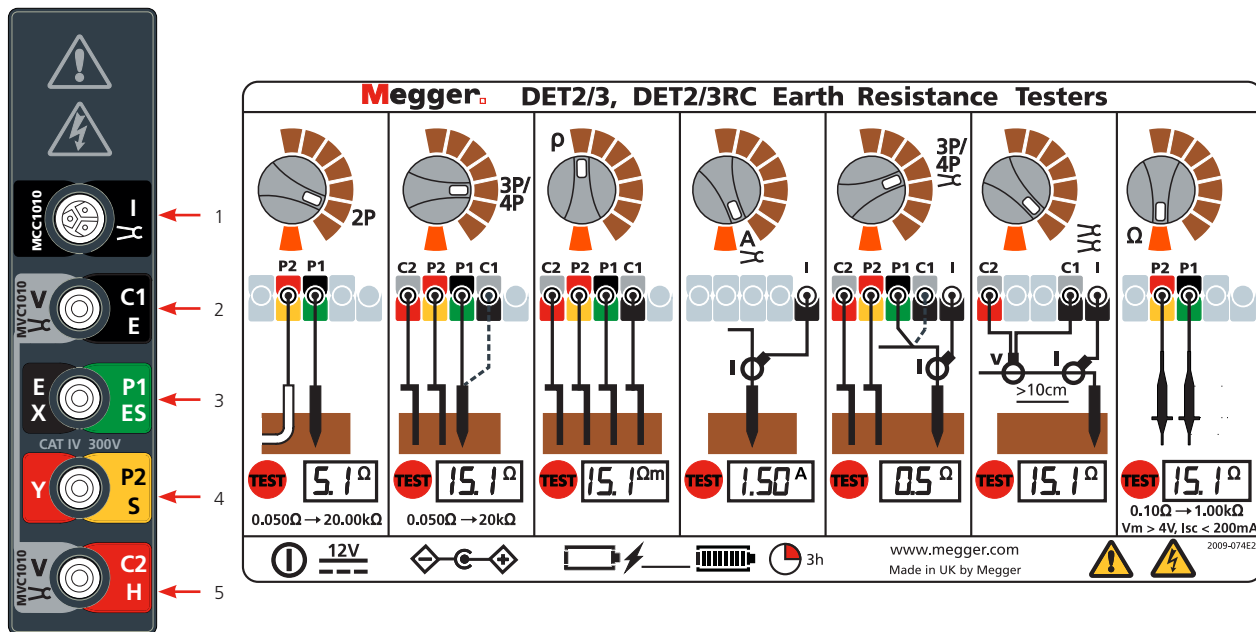







Terminals

See Test methods and set-up (page 23)

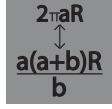

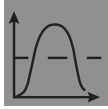
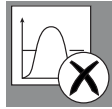
No.	Description
1	MCC1010 (used for ART, Noise current and stakeless tests)
2	MVC1010 / C1 E Voltage clamp, (current)
3	E/X / P1 ES (Potential)
4	Y / P2 S (Potential)
5	MVC1010 / C2 H Voltage clamp (current)

Soft keys

Soft Key	Description	Soft Key	Description
	Select 15 / 50 V		Delete all test records
	Noise filter on / off		Send all test records to USB
	Automatic frequency Scan		Delete single test record
	Earth / ground resistivity test method		Send single test record to USB
	Metres or feet		Average
	Clear		Null
	Back		Resistivity spacing adjustment

Operation

Before each use of the instrument, visually inspect the instrument case, test leads, stakes and connectors to confirm their condition is good, with no damaged or broken insulation.

Power on / off

- Rotate the mode switch away from **Off** to a mode to power up and activate the instrument
- Rotate the mode switch to **Off** to power down the instrument.

Auto off

The instrument switches **Off** after a period of inactivity (user adjustable) (see General set-up (page 12)).

To start the instrument again rotate the mode switch to **Off** and then select a mode.

Power options

- Internal battery
- Mains supply: The instrument charges using the dc adapter, which will work at voltages between 100 and 240 V ac. You may continue to use the instrument while the internal battery is charging. (See Battery charge (page 38)).
 - Green LED: On charge
 - Amber LED: External power On
- 12 V dc supply: Operate the instrument while connected to a 12 V dc supply. See 12 V supply (page 38).

See also Specifications (page 39).

Earth test options

Output voltage



The maximum output voltage of the instrument is ± 50 V. This can be reduced to ± 15 V for operation in situations which require it. The most appropriate output voltage should be selected by the user based on local safety procedures.

To change the output voltage

- Press  after the measurement mode is selected. The display will show the selected output voltage.

Test frequency

The instrument can either scan the usable frequency range to identify the test frequency with the lowest noise, or the frequency set be manually set, as required.

- **Auto:** Press . The instrument searches for the best frequency
- **Manual:** Press  to set a frequency between 10 Hz and 200 Hz

Noise filter

- Press  (noise filter) to give additional noise rejection on the input signal in order to produce more stable results, this will also extend the test duration.

Test leads and terminal connections

Test lead set-up and terminal connections are described as part of the test procedure.

Important: When the instrument is connected to electrodes, make sure that all leads and cables are fully unwound and laid out without loops.

Important: When running test leads out to each remote spike, take care not to lay them close to each other. This is to minimise the effect of mutual inductance. Test leads must be spread out at least one metre apart.

Test modes

The instrument can operate in two modes to do a test:

Manual mode

In manual mode the test result can be shown as a single digital read out result, or as a continuously updated digital read out result.

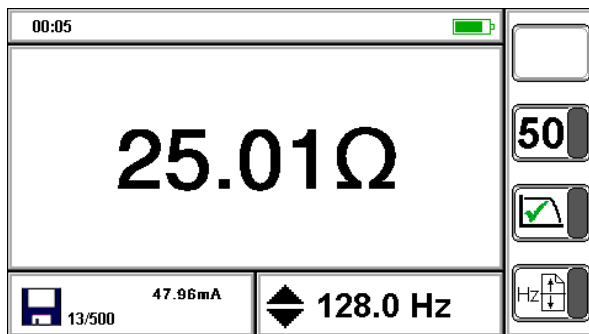

Continuous graphical mode

In continuous mode a continuous updated graph is displayed.

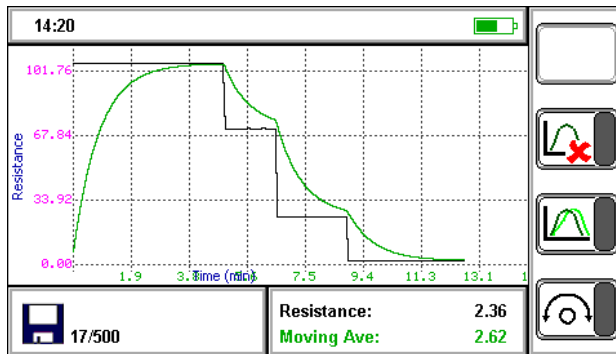



- Green line: Measurement line
- Black Line: Recorded average

Set-up

This section details the instrument set-up.

Modify parameters



1. Set the **Mode** switch to .
2. Press  to select a set-up group.
3. See instructions below for each set-up group.

Note: The set-up group screen is not active until  is pressed.

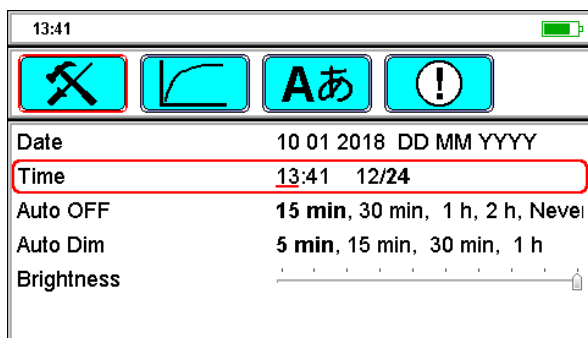

- Setting in **bold**: Current setting
- Setting underlined: Current selection

General set-up





1. Press  to scroll through the parameters
2. Press  to select the highlighted parameter.
3. Use  to move left and right through the parameter options.

Date / Time

1. Press  to modify current selected setting.
2. Press  to accept.

Auto Off / Auto Dim / Brightness



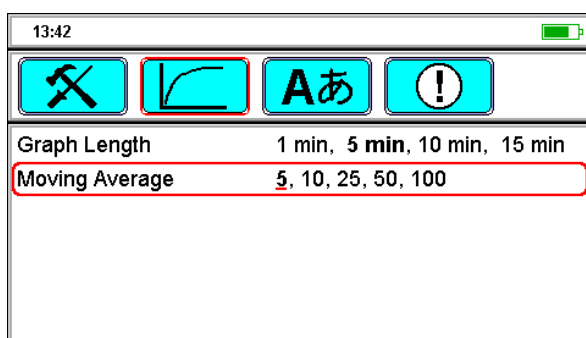

1. Press  to modify current selected setting.
2. Press  to accept.

 must be pressed to exit the parameter, even if no parameter was modified.

Graph set-up





- Graph length: 1, 5, 10, 15 min
- Moving Average: 5, 10, 25, 50, 100

1. Press  to scroll through the parameters.
 2. Press  to select the highlighted parameter.
 3. Use  to move through the options.
 4. Press  to accept.
-  must be pressed to exit the parameter, even if no parameter was modified.

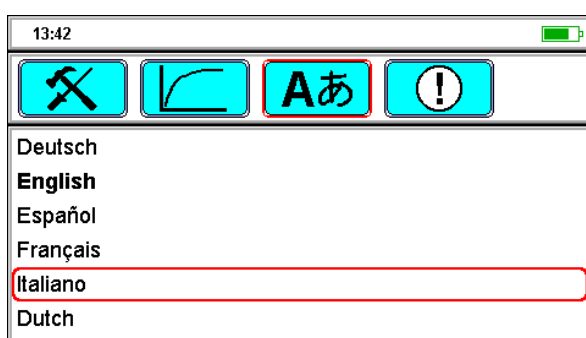
Language set-up



- Select the instrument language

1. Press  to scroll through languages.
2. Press  to select the highlighted language.

Earth / ground resistance

Test procedure

Warning: Make sure the circuit is de-energised, before the instrument is connected for measurement.

Note: Manual or Continuous Graphical Mode (see Test modes (page 11)).

Step

Manual Mode

OR

Continuous Graphical Mode

1

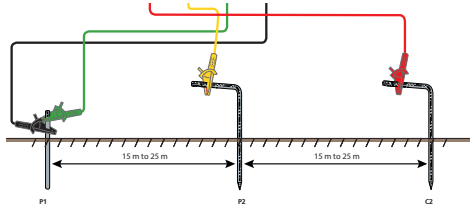

Connect pins / stakes

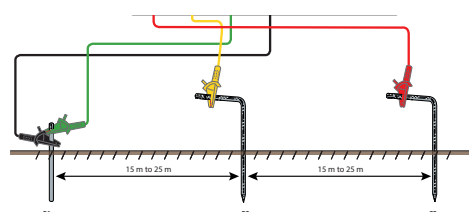

Connect pins / stakes

Note: Set up test leads and stakes as required by each test (do not connect the test leads to the instrument):

Test

Test Method

Set-up

4P / 4P ART

Fall of potential

Four terminal test lead set-up (page 23)

3P / 3P ART

Fall of potential

Three terminal test lead set-up (page 24)

Fall of potential

Three terminal ART test lead set-up (page 24)

4P / 4P ART

Slope method

Slope four terminal test lead set-up (page 27)

3P / 3P ART

Slope method

Slope three terminal test lead set-up (page 28)

4P / 4P ART

61.8% rule

61.8% Four terminal test lead set-up (page 29)

3P / 3P ART

61.8% rule

61.8% Three terminal test lead set-up (page 29)

2P

Two terminal earth resistance test (page 29)

2 Clamp

Two clamp (stakeless) test (page 30)

2

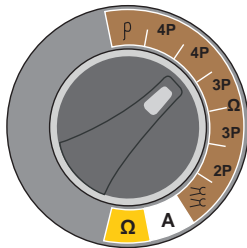

Set the function

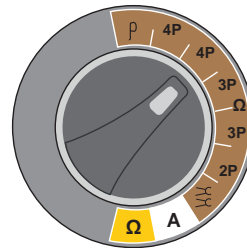

Set the function

3

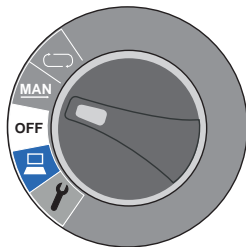

Set the mode

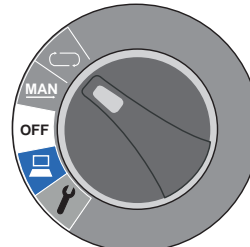

Set the mode

Manual mode

OR

Continuous graphical mode

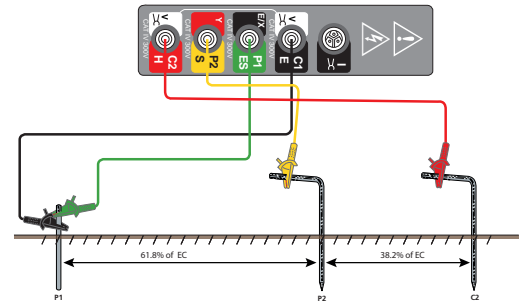
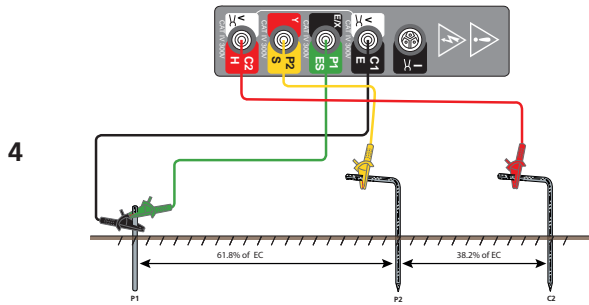

Connect test leads to instrument

Connect test leads to instrument

Set test parameters

Set test parameters

Note:

15/50V : 15 or 50 test voltage

: Manually select a frequency

: Automatically select a frequency

: Noise filter on or off

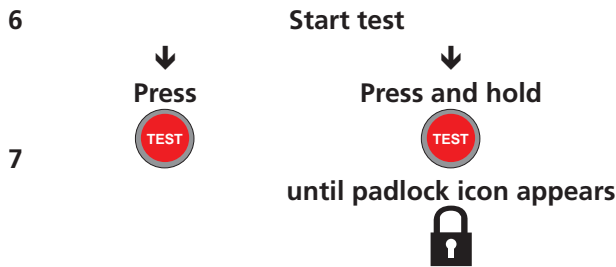

- : Stop the current data stream and restart the graph.
- : Activate / deactivate the average display
- : Go back to test settings (the Ready screen)

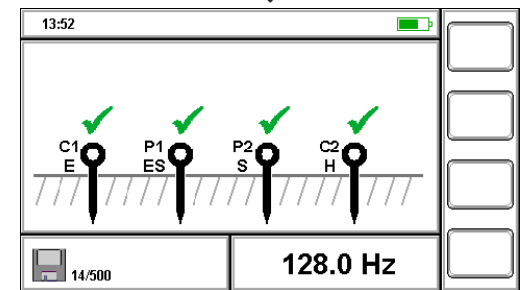
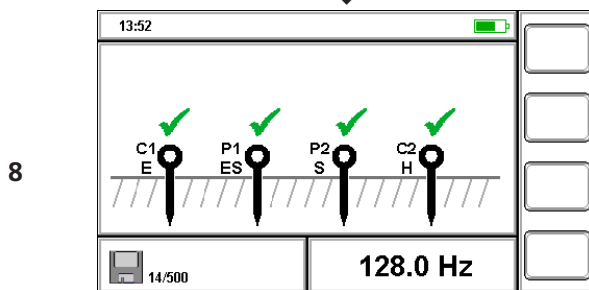

End Test

End Test



Manual mode

10

11

Press / Repeat test

OR

Continuous graphical mode

11

Press / Repeat test

See Data management (page 33).

Repeat test if required. While the test result is shown, test parameters can be modified for the next test. If required test parameters can be repeated.

Earth / ground resistivity

Test procedure

Setup test

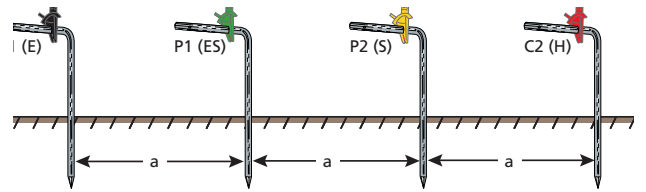

1 Connect pins / stakes

Wenner or

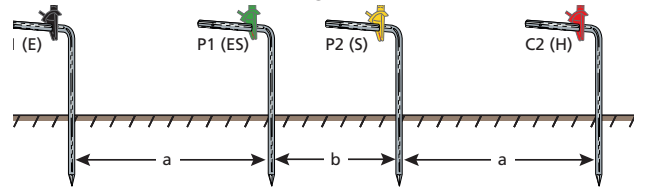

Schlumberger

Note: Set up the test leads and stakes as required by the selected test method (on screen).
Do not connect the test leads to the instrument.

2 Set function to ρ

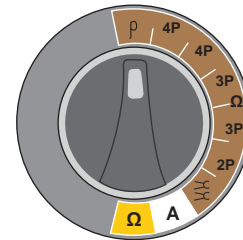

3 Set the mode
Manual or **Continuous**
(see Test modes (page 11)).

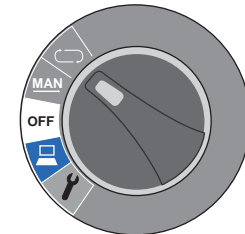

4 Select test method

$$\frac{2\pi aR}{a(a+b)}$$

Wenner or Schlumberger



Adjust parameters

Set test measurements

m/ft

Metres or Feet

Resistivity

The DET2/3 can measure and calculate resistivity using the Wenner or Schlumberger methods. These are very similar, both involving placing four pins / stakes into the earth / ground. These only penetrate the soil by a short distance.

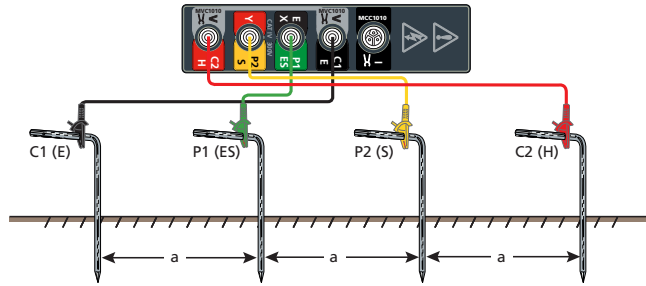

The Wenner method is the most common with the pins / stakes equally spaced in a line. The resistivity is calculated in the equation:

$$\rho = 2\pi aR$$

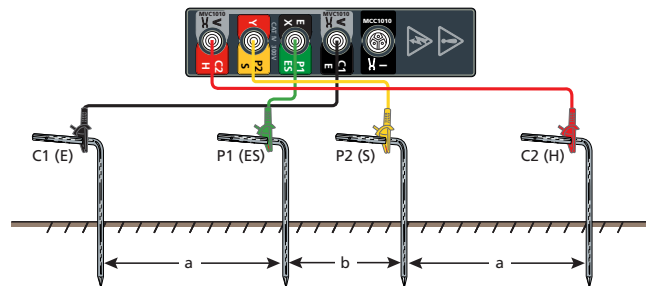

The Schlumberger method has the potential pins / stakes closer together, with $a < 2b$. The resistivity is calculated in the equation:

$$\rho = \pi \frac{a(a+b)}{b} R$$

5 Press **OK**

6 Connect test leads to instrument

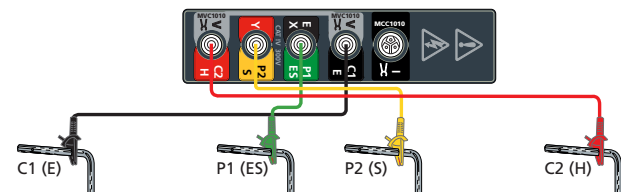

7 Set test parameters

<p>15/50V 15 or 50 test voltage</p> <p> Set a frequency</p>	<p> Automatically find a frequency</p> <p> Noise Filter On or Off</p>
---	---

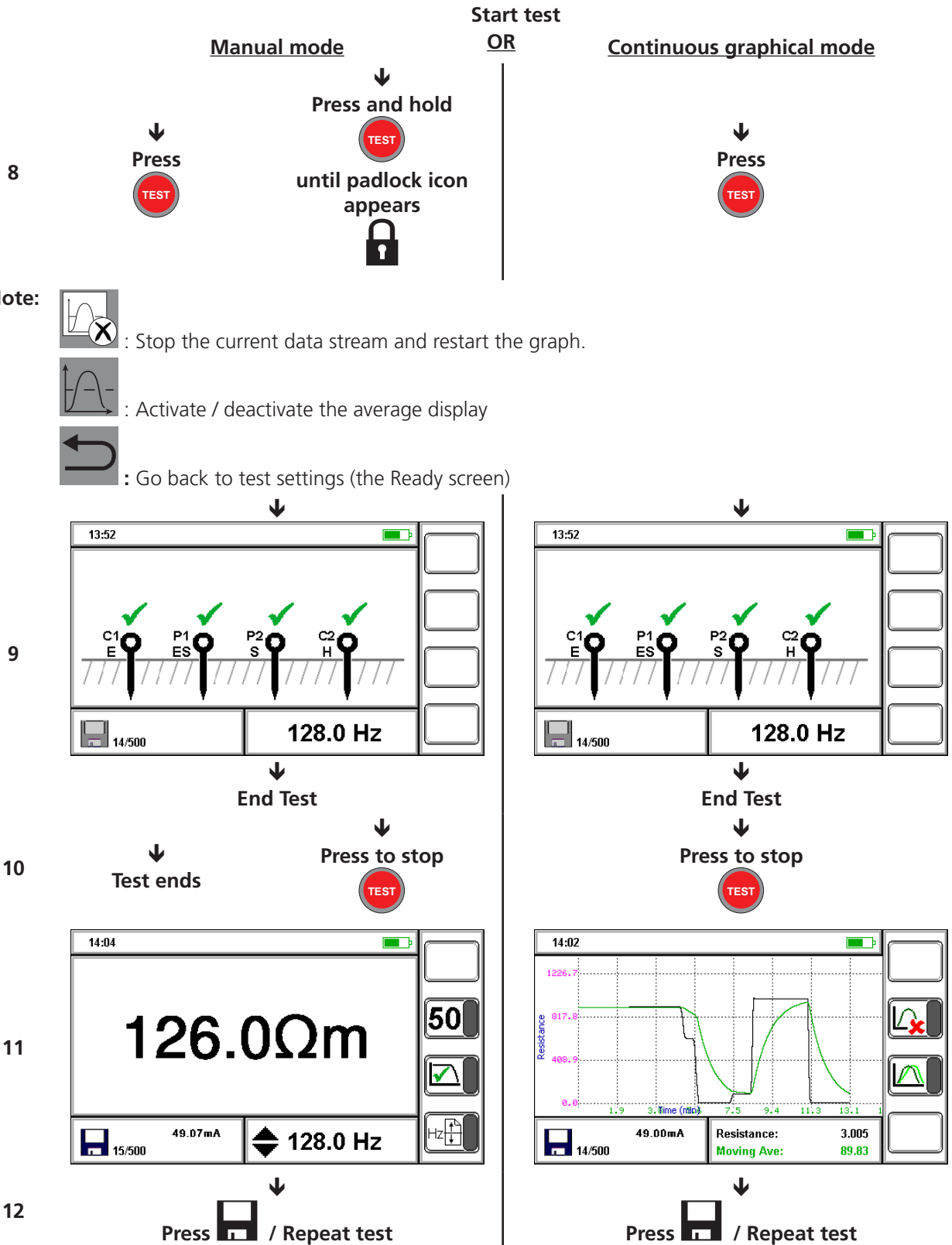

Note: See Data management (page 33).

Repeat test if required. While the test result is shown, test parameters can be modified for the next test, if required.

Continuity Test

Warning: Make sure the circuit is de-energised, before the instrument is connected for measurement.

Note: To remove any test lead resistance in the test result, Null the test leads (see Null test leads (page 21)).

Test procedure

1 Set function to Ω

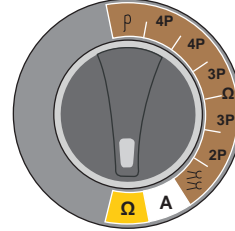

2 Set the mode

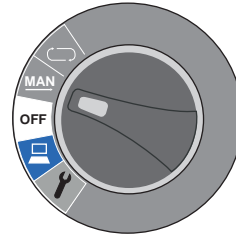

3 Connect test leads to instrument

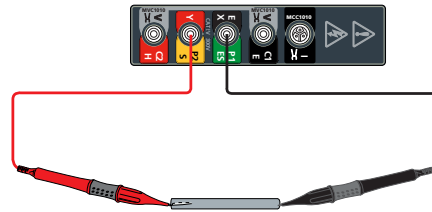

Start test

4 Manual mode

Press to start



OR

Continuous graphical mode

Press



Clear: Stop the current data stream and restart the graph.



Average: Activate / deactivate the average display.

End test

5 Press to stop



Press



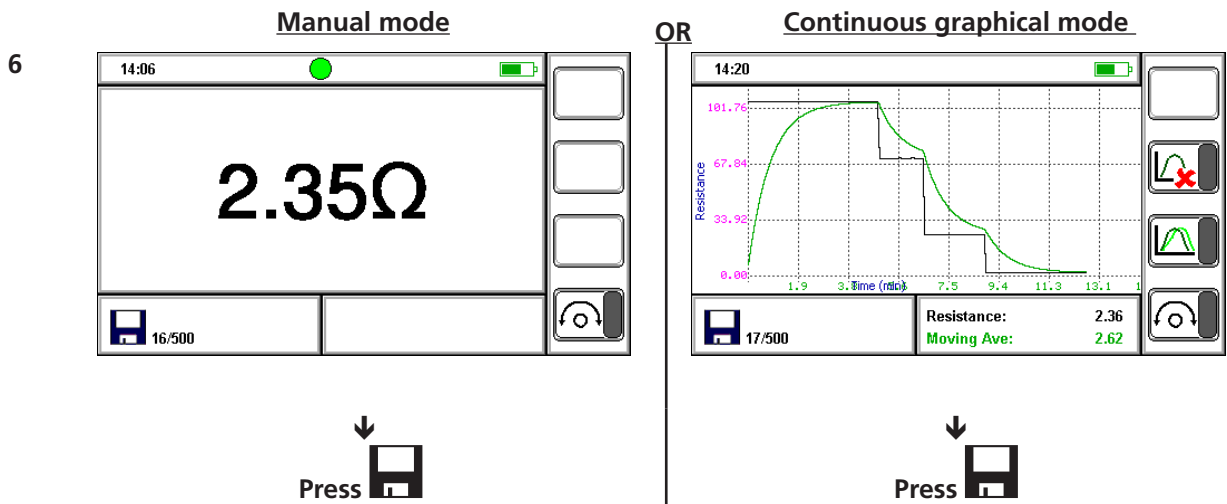

See Data management (page 33).

Note: Press Save at any time to save the current reading.

Null test leads

Note: Test must be running to be able to Null the test leads.

The Null function only works when the measured resistance is less than 10 Ω.

1. Put the two test lead tips firmly together.

2. Press

■ When the test result shows, press again to activate / de-activate the Null process:

- **Null** active: Result is minus the test lead resistance.

The Null function is active while results are continuously updated or when results update is stopped.

- **Null** de-active: Result includes test lead resistance.

If the measured resistance is below zero, while Null is active, the result will show that it is too low to measure (the instrument will not show negative resistance values).

Leakage Current Test

Test procedure

- 1 Connect MCC1010
- 2 Set function to A

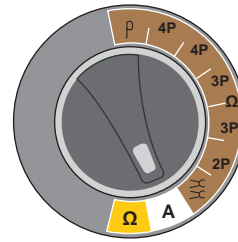

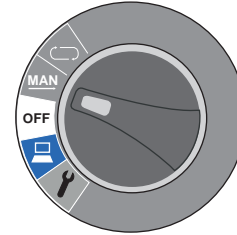

- 3 Set the mode

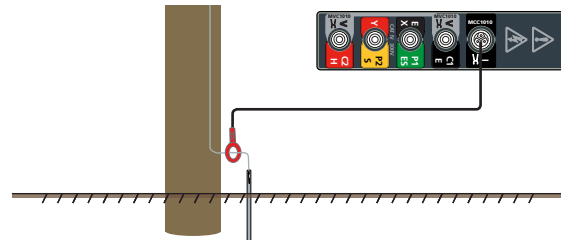

- 4 Place MCC1010 around conductor to be tested



- 5

<p><u>Manual mode</u></p> <p>↓</p> <p>Press to start</p> 	<p>OR</p>	<p><u>Continuous graphical mode</u></p> <p>↓</p> <p>Press</p> 
<p>End Test</p>		

Note:



Clear: Stop the current data stream and restart the graph.



Average: Activate / deactivate the average display.

- 6

<p>↓</p> <p>Press to stop</p> 

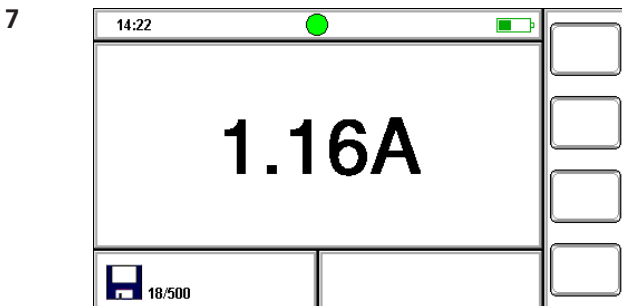

- 8

<p>Press </p>
--

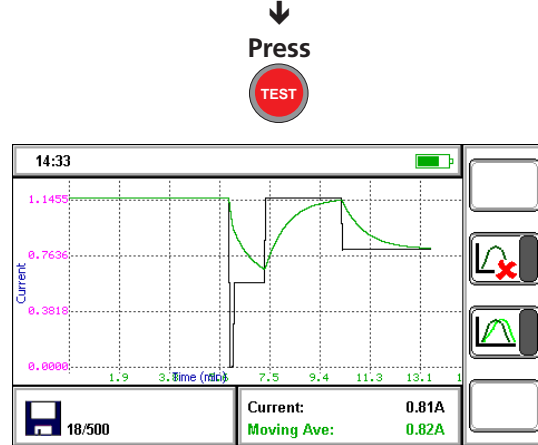

- 8

<p>Press </p>
--

See Data management (page 33).

Test methods and set-up

The test methods detailed in this section is not exhaustive, see the booklet '**Getting Down To Earth**' for more information on other tests and methods.

Key to images in this section:

- P: Potential spike
- C: Current spike
- E: Electrode

Fall of potential (FoP) test

Important: The current stake / pin, potential stake / pin and earth electrode must be placed in a straight line.

Important: When running test leads out to each remote stake / pin, take care not to lay them close to each other. This is to minimise the effect of mutual inductance.

Four terminal test lead set-up

1. Insert the current stake / pin into the earth 30 to 50 metres away from the earth electrode to be tested.
2. Insert the potential stake / pin into the earth midway between the current test spike and the earth electrode.
3. Firmly connect terminal **C1** and **P1** to the earth electrode as shown.
4. Move the potential stake / pin three metres further away from the earth electrode and make a second resistance measurement.
5. Move the potential stake / pin three metres nearer the electrode (than the original position) and make a third resistance measurement.

If the three resistance readings are similar (within the required accuracy) then their average can be taken as the resistance to earth of the electrode.

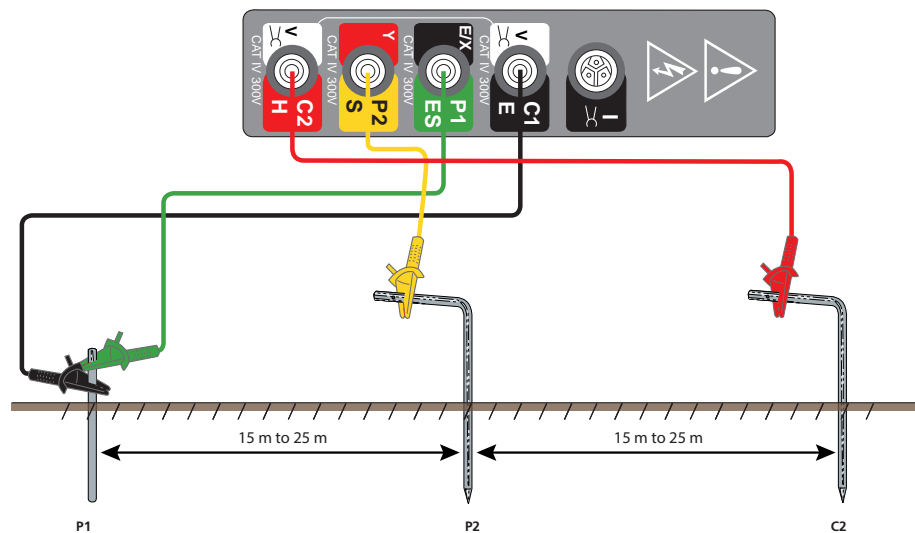

Four terminal ART test lead set-up

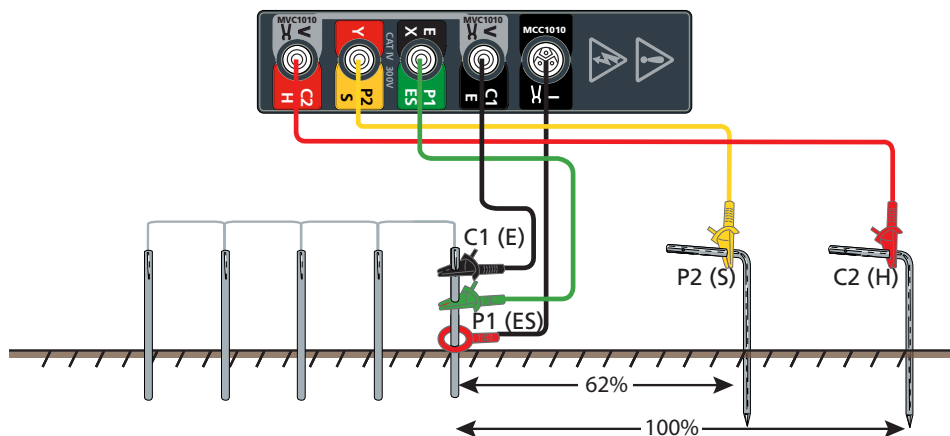

Three terminal test lead set-up

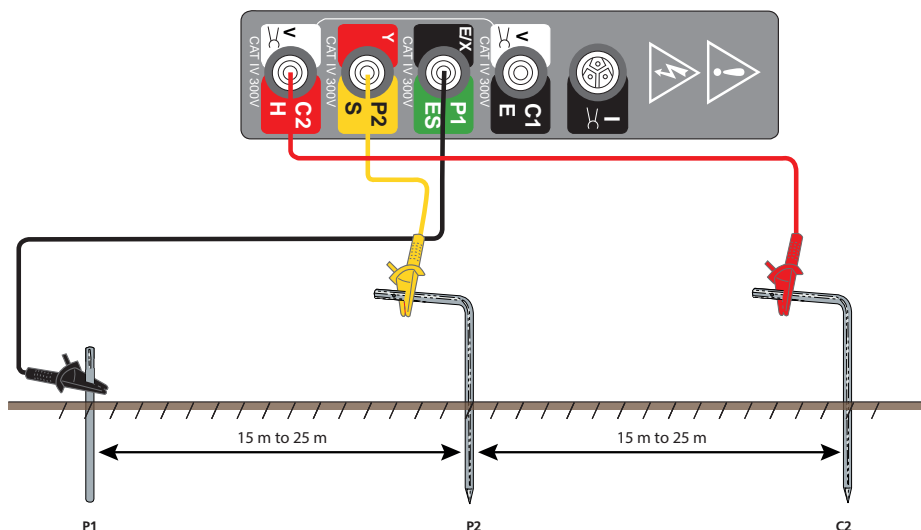

Important: The current stake / pin, potential spike and earth / ground electrode must be placed in a straight line.

Important: When running test leads out to each remote stake / pin, take care not to lay them close to each other. This is to minimise the effect of mutual inductance.

Determine the earth electrode test lead resistance

The earth electrode test lead resistance can be determined separately.

1. Remove the test lead from the earth electrode and connect to the **C2** and **P2** terminals.
2. Press test.

The lead resistance can then be deducted from the earth resistance measurements.

This procedure is not required if the **C1** and **P1** terminals are connected by separate test leads.

Note: The result for a three terminal test will include the resistance of the test lead used to connect to the earth electrode under test. The resistance can be measured by connecting the lead to the P1(X) and P2(Y) terminals, selecting a 2P test and pressing the test button. This lead resistance can be subtracted from the earth resistance measurements.

Three terminal ART test lead set-up

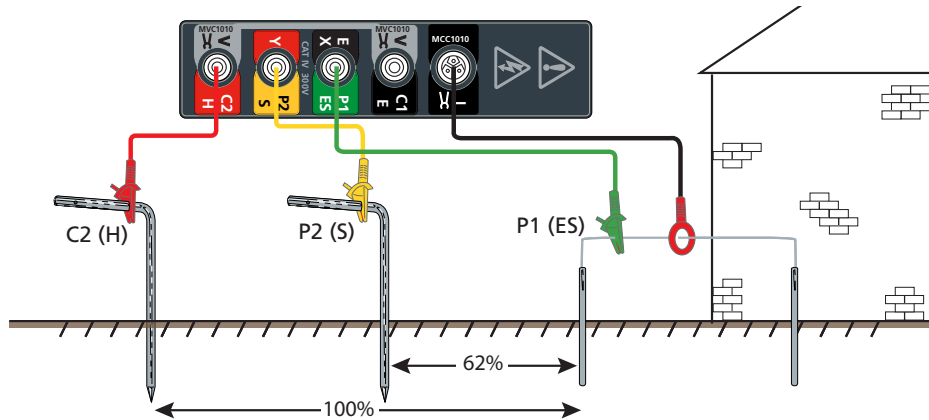

Slope method (FoP)

Description

Extract from the technical guide **Getting Down to Earth**:

It has been shown that the true earth resistance of an electrode system is obtained when the temporary potential P is positioned at a distance from the electrical centre of the system equal to 61.8% of the distance from the electrical centre to the temporary current probe. This principle is used in the technique called 'Intersecting Curves' explained in **Getting Down to Earth**. It becomes apparent that the method is complex in nature and requires some trial and error calculations.

A further technique was evolved and is described below. It is easier to use and has been shown to give satisfactory results, both in theoretical and practical cases and when the soil is nonhomogenous. It is called the Slope Method.

To apply the Slope Method:

1. Choose a convenient rod E to which the Earth Tester can be connected. E is one of many parallel rods forming the complex earth system.
2. Insert the current probe at a distance (D_c) from E (D_c is normally two to three times the maximum dimension of the system).
3. Insert potential probes at distances equal to 20% of D_c , 40% of D_c and 60% D_c .
See examples in step 4.
4. Measure the earth resistance using each potential probe in turn. Let these resistance values be R_1 , R_2 and R_3 respectively.

Examples:

- $R_1 = 0.2 \times D_c$
- $R_2 = 0.4 \times D_c$
- $R_3 = 0.6 \times D_c$

5. Calculate the value of:

$$\mu = \frac{R_3 - R_2}{R_2 - R_1}$$

The resultant is called μ and represents the change of slope of the resistance / distance curve.

6. Refer to Table 1: Values of D_p / D_c for various values of μ (page 27) to find the corresponding value of D_p / D_c for μ .

7. Since D_c (distance to the current probe) is already known, calculate a new D_p (distance of the potential probe) then insert the potential probe at this new distance from E.

$$D_p = D_p/D_c \times D_c$$

Now measure the earth resistance by placing the potential probe at this new distance D_p . This measurement is known as the 'true' resistance.

8. Repeat the whole process for a larger value of D_c . If the 'true' resistance decreases appreciably as D_c is increased, it is necessary to increase the distance of D_c still further. After making a number of tests and plotting the 'true' resistance, the curve will begin to show less of a decrease and will indicate more stable readings. It is at this point the resistance of the earthing system is noted.

Note: As with other earth testing techniques, some experimentation may be necessary to ascertain if the practical result is as accurate as the theory appears to indicate.

The Slope Method has been designed to eliminate the need for impractically long leads by the ability to interpolate the correct distance along the combined resistance curve, i.e. the curve of the current probe's resistance superimposed upon that of the tested grid, without sufficient spacing to produce the characteristic 'flat portion' between.

One particular observation on the Slope Method is that if the calculation of μ is greater than that given in the table, the distance C must be increased.

Secondly, before the measured values for R_1 , R_2 and R_3 can be accepted with a degree of confidence, it is recommended that a curve be plotted which will identify any localized effects and eliminate uncharacteristic readings from the calculations. Thirdly, it is also suggested that the test be repeated in different directions and with different spacings. The various results should exhibit a reasonable degree of agreement.

Table 1: Values of D_p / D_c for various values of μ

μ	D_p / D_c	μ	D_p / D_c	μ	D_p / D_c
0.40	0.643	0.80	0.580	1.20	0.494
0.41	0.642	0.81	0.579	1.21	0.491
0.42	0.640	0.82	0.577	1.22	0.488
0.43	0.639	0.83	0.575	1.23	0.486
0.44	0.637	0.84	0.573	1.24	0.483
0.45	0.636	0.85	0.571	1.25	0.480
0.46	0.635	0.86	0.569	1.26	0.477
0.47	0.633	0.87	0.567	1.27	0.474
0.48	0.632	0.88	0.566	1.28	0.471
0.49	0.630	0.89	0.564	1.29	0.468
0.50	0.629	0.90	0.562	1.30	0.465
0.51	0.627	0.91	0.560	1.31	0.462
0.52	0.626	0.92	0.558	1.32	0.458
0.53	0.624	0.93	0.556	1.33	0.455
0.54	0.623	0.94	0.554	1.34	0.452
0.55	0.621	0.95	0.552	1.35	0.448
0.56	0.620	0.96	0.550	1.36	0.445
0.57	0.618	0.97	0.548	1.37	0.441
0.58	0.617	0.98	0.546	1.38	0.438
0.59	0.615	0.99	0.544	1.39	0.434
0.60	0.614	1.00	0.542	1.40	0.431
0.61	0.612	1.01	0.539	1.41	0.427
0.62	0.610	1.02	0.537	1.42	0.423
0.63	0.609	1.03	0.535	1.43	0.418
0.64	0.607	1.04	0.533	1.44	0.414
0.65	0.606	1.05	0.531	1.45	0.410
0.66	0.604	1.06	0.528	1.46	0.406
0.67	0.602	1.07	0.526	1.47	0.401
0.68	0.601	1.08	0.524	1.48	0.397
0.69	0.599	1.09	0.522	1.49	0.393
0.70	0.597	1.10	0.519	1.50	0.389
0.71	0.596	1.11	0.517	1.51	0.384
0.72	0.594	1.12	0.514	1.52	0.379
0.73	0.592	1.13	0.512	1.53	0.374
0.74	0.591	1.14	0.509	1.54	0.369
0.75	0.589	1.15	0.507	1.55	0.364
0.76	0.587	1.16	0.504	1.56	0.358
0.77	0.585	1.17	0.502	1.57	0.352
0.78	0.584	1.18	0.499	1.58	0.347
0.79	0.582	1.19	0.497	1.59	0.341

Slope four terminal test lead set-up

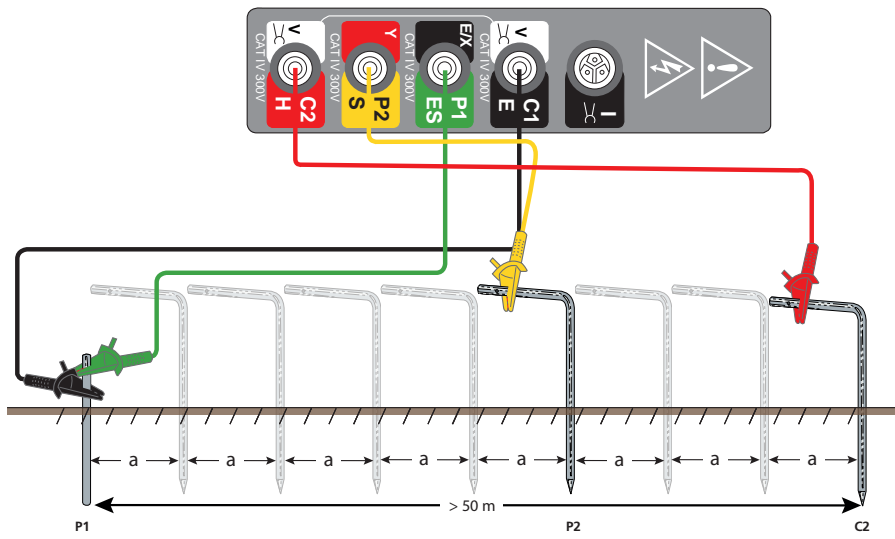

Slope three terminal test lead set-up

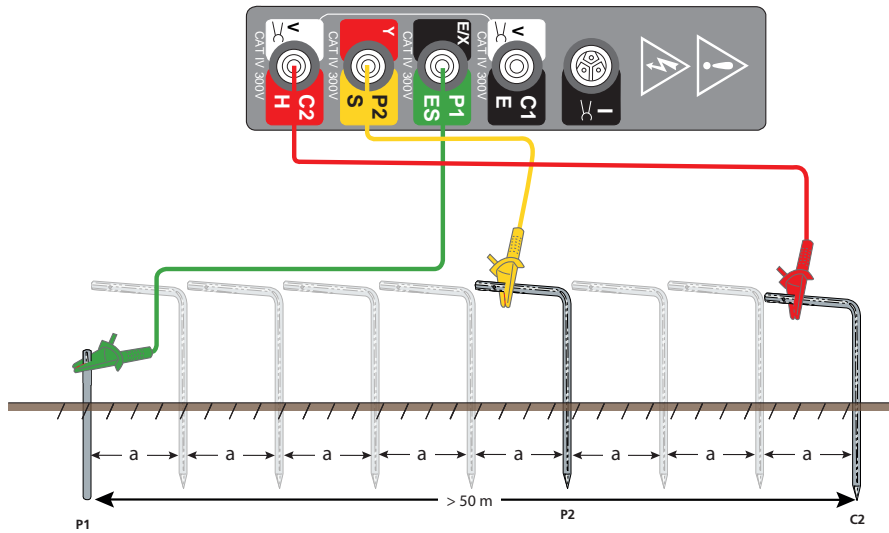

61.8% Rule (FoP)

61.8% Four terminal test lead set-up

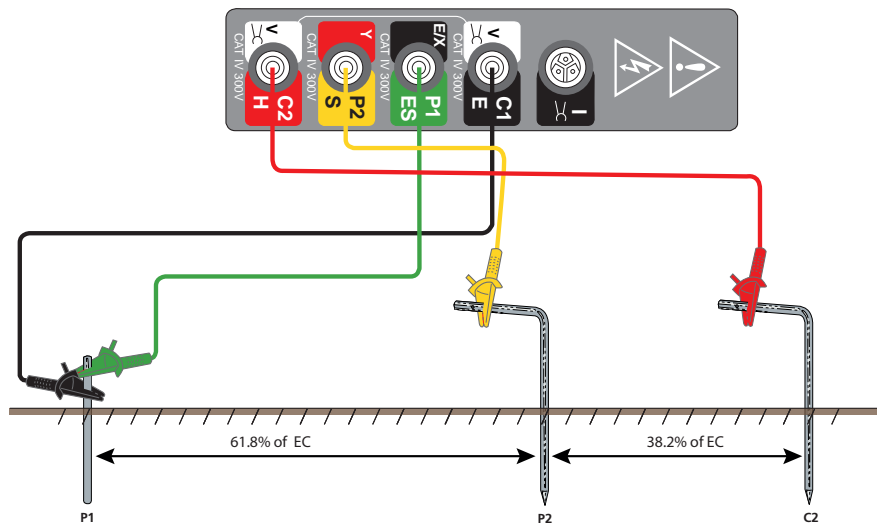

61.8% Three terminal test lead set-up

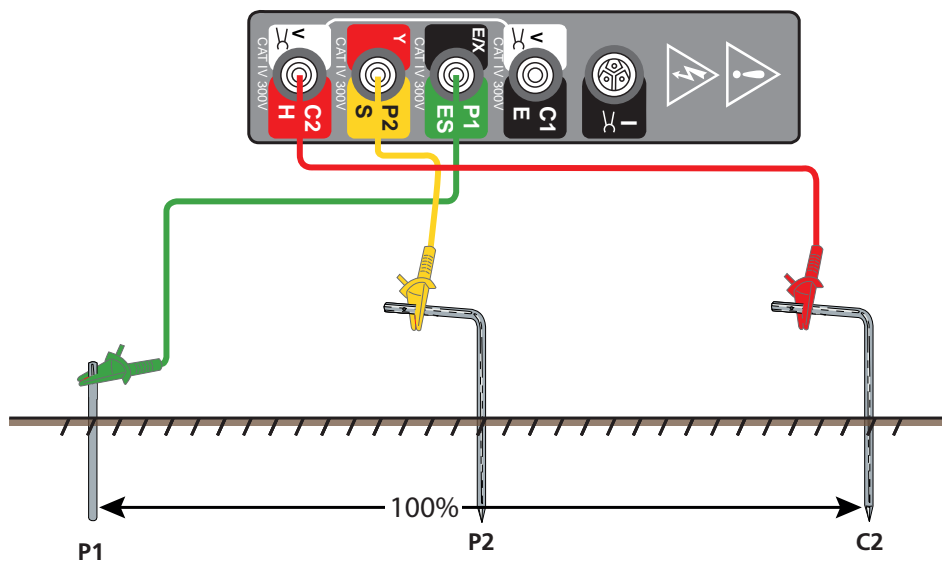

Two terminal earth resistance test

Warning: Make sure the circuit is de-energised, before the instrument is connected for measurement.

This will measure the resistance between the P1(X) and P2(Y) terminals using an ac test voltage. This method may not be suitable for continuity and bonding tests (refer to local regulations).

Note: The test voltage used for the two pole resistance test is ac and may not be suitable for all continuity tests (see local regulations).

Note: If the earth noise voltage is above 50 V peak to peak (18 Vrms), the display will show a warning triangle and an excessive noise voltage indicator.

- Set up the test leads and stakes as required (do not connect the test leads to the instrument):

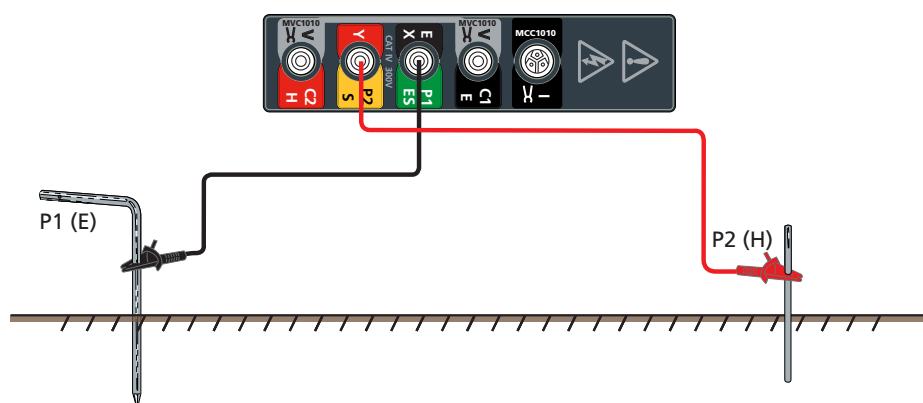

Two clamp (stakeless) test

The two clamp (stakeless) test uses both the MVC1010 and MCC1010 to obtain a measurement for the electrode under test.

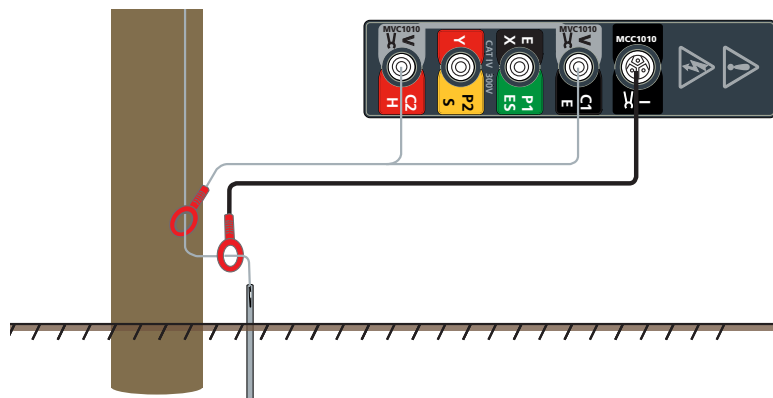

Calibration check tools

The instrument's calibration should be checked, before and after each test, against the calibration check tool.

Instrument calibration check

1. Make sure that the mode switch is set to **Off**.
2. Connect the instrument as shown:

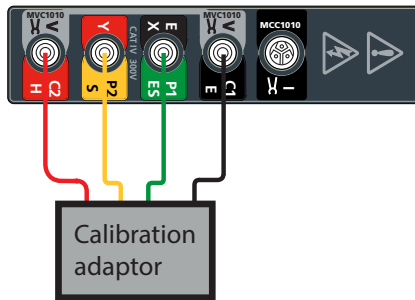

3. Set the function switch to 2P, 3P or 4P.
4. Start a test:
 - Press and release TEST.

The instrument completes pre-measurement checks.

The resistance is shown and should match the value written on the calibration check tool.

Checking instrument accuracy

- Instrument accuracy: 0.5% (+ 2 digits). At 25 Ω this gives an allowed measurement range of +/- 0.145 Ω .
- Calibration check tool accuracy: 0.1%. At 25 Ω this gives an allowed variation of 0.025 Ω .

Therefore a test, which uses the 4 pole position, will produce the following bands:

- $25 + 0.145 + 0.025 = 25.17$ (a figure greater than this is out of specification)
- $25 + 0.145 - 0.025 = 25.12$ (a figure between 25.12 and 25.17 is possibly out of specification)
- $25 - 0.145 + 0.025 = 24.88$ (a figure between 24.88 and 25.12 is in specification)
- $25 - 0.145 - 0.025 = 24.83$ (a figure less than this is out of specification)

Clamp calibration check

1. Make sure that the mode switch is set to **Off**.
2. Connect the instrument as shown:

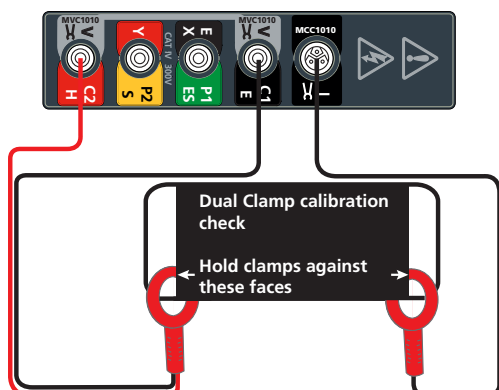

3. Close the MCC1010 around one loop of the clamp calibration check tool.
4. Close the MVC1010 around the other loop of the clamp calibration check tool.
5. Make sure that there is a minimum separation of 100 mm between the MCC1010 and MVC1010.

6. Set the function switch to .

7. Start a test:

- Press and release TEST.

The instrument completes pre-measurement checks.

The two-clamp resistance is shown and should match the value written on the clamp calibration check tool.

Note: Make sure that the MCC1010 and MVC1010 jaw mating surfaces are free of dust and contamination and that they make a good contact with each other when the jaws are closed.

Data management

Use test result management mode of view saved test results and transfer saved test results to USB drive or PC.

Test result data is saved in two formats:

- As a **Data File**: Data saved from manual or guided mode saved as a single data file.
- As a **Graph File**: Data saved from continuous mode saved as a graph of a complete test.

Data file records

Record Number	Test Mode	Result	Time	Date
13	R21		17:17	08/01/201
14	4P	25.01 R	00:05	01/01/200
16	Resistivity	126.0 Rm	14:04	10/01/201
17	Continuity	2.35 R	14:06	10/01/201

Record Number: 1/4 | Record Name: 0013

Graph file records

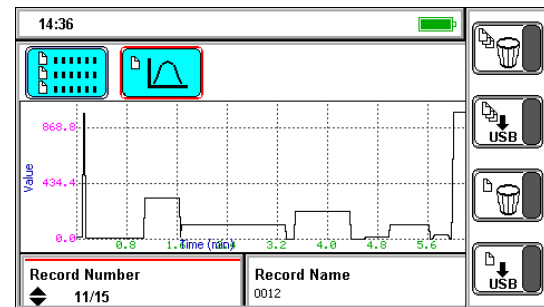

Up to 500 test records can be saved (data and graph files). A test record is either:

- Manual mode: A single test record, several saved records may be required to complete a test.
- Continuous mode: A single test record as a graph file.

Note: A pop-up error dialogue box will show when the memory is full to tell the user to clear some space.

Save test result

1. Press when the save icon is displayed.

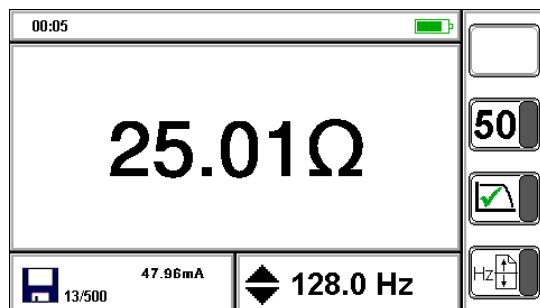

The test is assigned a record number.

To edit a record file name as...

1. Set the mode switch to
2. Press to select or
3. Press
4. Press to select **record name** (Red bar visible)
5. Press to select a test result

6. Press **OK** to move to **Asset ID**.
(Red bar visible)

7. Press **OK**.

- Data file: Test001.tab.
- Graph file: Graph001.tab.

8. Enter a test result three digit number.

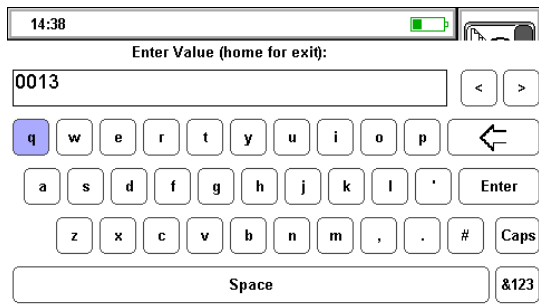

Keyboard show - use arrow keys to navigate.

9. Press  to save and return.

The save icon will display when save function is available.

Press save button and a record number will display.

Note: In continuous graphical mode save can be pressed at any time.

USB connection

A USB type socket is provided for this purpose on the top of the DET2/3. The position is clearly marked with a USB symbol.



Single test result: download or delete

Connect a USB memory device to the instrument.

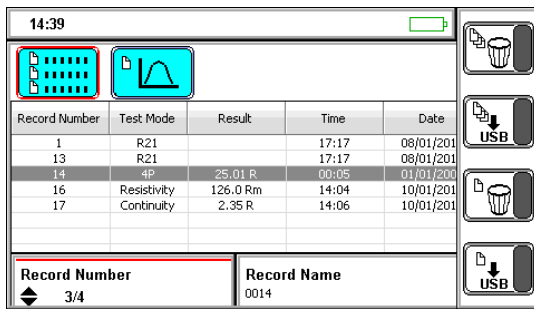

1. Set the mode switch to
2. Select or
3. Press
4. Press to select **record number**
(Red bar visible)
5. Press to select a test result:

Download a single test record

- Press .
The selected test record is downloaded (copied) to the connected device

Delete a single test record

- Press .
The selected test record is deleted

Multiple test results: download or delete

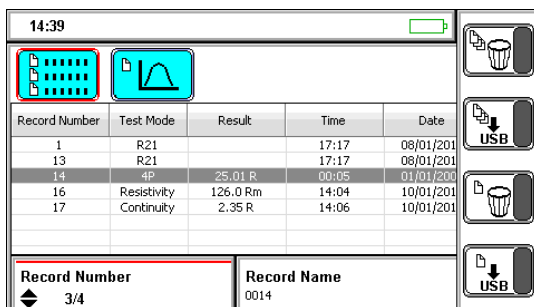

6. Select or .
7. Press .

Download all test records

- Press .
The selected test records are downloaded (copied) to the connected device

Delete all test records

- Press .
All saved test records are deleted

Maintenance

General maintenance

- Test leads should be checked before use for damage and continuity.
- Ensure the unit is kept clean and dry after use.
- Close all covers and flaps when not in use.

Cleaning

1. If connected, disconnect from mains power.
2. Wipe the Instrument with a clean cloth dampened with either water or isopropyl alcohol (IPA).

Battery

Caution: Old batteries must be disposed of in accordance with local regulations.

Caution: Always set the instrument to Off and remove test leads before battery is removed and installed. Only use approved batteries supplied by Megger.

Approved batteries (see Specifications (page 39)).

To help maintain the health, reliability and longevity of the installed battery:

- Make sure that the battery is fully charged before the instrument is used
- Keep the battery charged up whenever possible while in use. Li-Ion batteries prefer frequent top-ups and should never be left in a flat state for extended periods as this can cause permanent damage
- If the battery is to be stored for extended periods maintain a charge of 40%, allow for some discharge and maintenance of the protection circuit.
- Store the battery in a cool, dry place. Li-ion batteries can get stressed when exposed to heat which can reduce its life. See Specifications (page 39).

Battery status

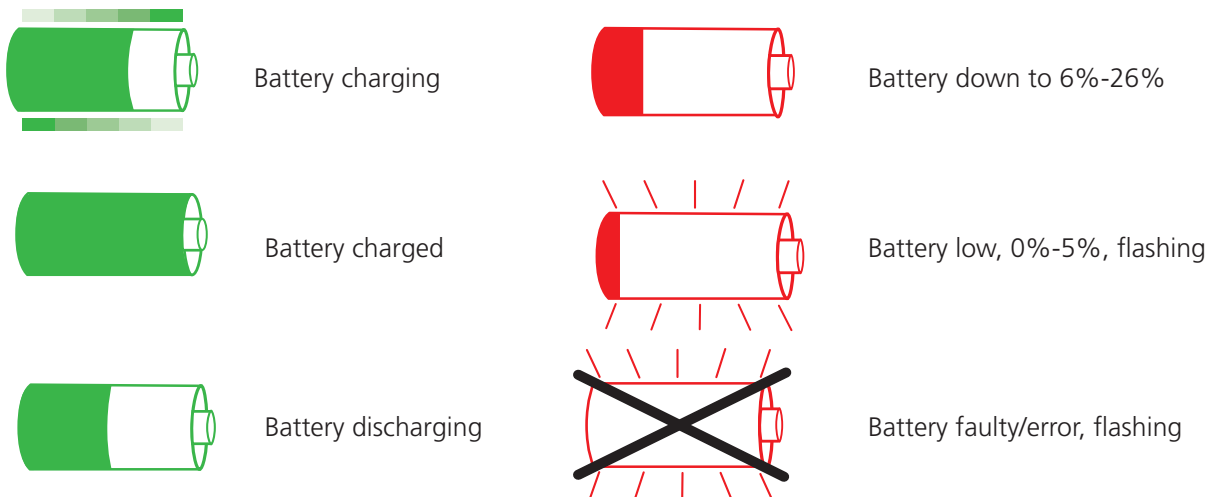

When running from the battery, the above will indicate the current state of charge (the icon will be filled proportionally to the state of charge). When the battery is charging, it will show an animation that starts with the current state of charge and fills the indicator to 100 %, then repeats. Once the battery is full, the animation will stop. If the charger is connected (and on), but unable to charge the battery, the icon will flash.

Capacity and typical charge life 10 hours max.

Battery replacement.

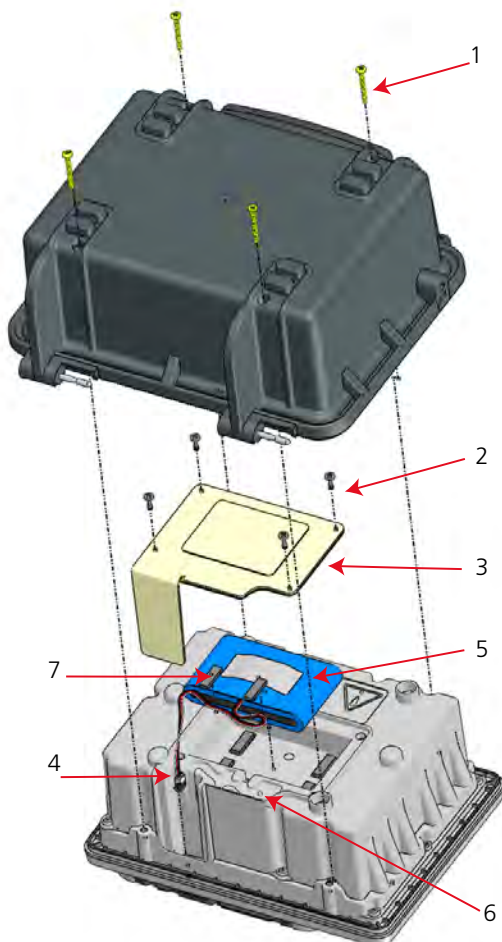

Warning: Disconnect all leads before removing case.

Caution: Protect the face and switches of the instrument when turning it upside-down.

Note: Replace with Megger approved battery, part number 1002-552 only.

1. Remove lid by opening to approximately 70° and sliding right.
2. Switch the instrument **Off**.
3. Disconnect all leads .
4. Invert the lower case and rest the front panel on a soft surface so as not to damage the keypad.
5. Remove 4 fixing screws (1) and lift off the case.
6. Undo 4 fixing screws (2), remove battery cover (3).
7. Disconnect battery connector (4) and lift foam strips (7) to release the battery lead.
8. Remove battery (5).
9. Connect new battery to connector (5).
10. Install new battery ensuring correct orientation and that lead is correctly routed in slot (6). Secure lead using foam strips (7).

Warning: Do not reconnect any test leads until the battery cover is fitted.

1. Refit battery cover (3) and secure using 4 screws (2) to torque 20 cNm.
2. Refit case and secure using 4 screws (1) to torque 40 cNm.
3. Turn instrument upright and refit lid.

Note: The battery must be disposed of according to local environmental regulations.

Battery charge

Note: Make sure the ambient temperature is correct to charge a battery (see Specifications (page 39)).

When the battery status indicator shows the battery is nearly discharged or is discharged, recharge the battery as detailed below.

The DET2/3 can be used while the battery is on charge. The instrument will charge faster when switched off.

A charge cycle on a fully discharged battery takes approximately four hours (see the Battery status (page 36)).

1. Switch the instrument **Off**.
2. Disconnect the instrument from all electrical circuits.
3. Open the external power socket rubber door.
4. Connect the ac / dc adaptor (amber LED shows for two seconds then changes to green (charging)).
5. When fully charged the LED shows steady amber (power connected - battery charged).
6. Once the charge cycle has started the instrument can be used as normal.

12 V supply

When the battery status indicator shows the battery is nearly discharged or is discharged, use the power supply provided with the instrument to recharge the battery. The instrument will function normally with the power supply in use. Use only the power supply provided by Megger; other supplies may introduce noise into the measurement, affecting accuracy and instrument stability.

Note: The LED indicating the instrument is connected to an external 12 V supply will go amber if the charger is connected (and on), but unable to charge.

The instrument will now operate on the 12 V dc supply.

Specifications

Only values with tolerance or limits are guaranteed data. Parameters without tolerances are for information only.

Measurement specifications

2, 3 and 4 terminal resistance

Range	0.001 Ω to 20.00 k Ω Auto range
Accuracy	at 23 °C $\pm 0.5\%$ of reading ± 2 digits
3P	± 10 m Ω
2P	± 20 m Ω
Operational uncertainty	$\pm 2\%$ of reading ± 2 digits Meets IEC61557 operational uncertainty requirement with readings over 10 m Ω when spike resistances are below 100 Ω $\pm 5\%$ of reading ± 2 digits ± 10 m Ω Meets IEC61557 operational uncertainty requirement with readings over 50 m Ω

4 and 3 terminal ART (selective) resistance

Range	0.01 Ω to 10.00 k Ω auto range
Accuracy	$\pm 5\%$ accuracy (± 3 digits) at 23°C $\pm 2^\circ\text{C}$

Stakeless resistance

Range	0.01 Ω to 200 Ω
Accuracy	$\pm 7\%$ (± 3 digits)
Test to standards	BS 7430 (Earthing) BS 62305 (Lightning) IEEE Standard 81
Test frequency 2P, 3P & 4P resistivity	10 Hz to 200 Hz (steps of 0.5 Hz)
Test frequency dual clamp, 3p ART & 4P ART	70 Hz to 200 Hz (steps of 0.5 Hz)
Test current	50 mA max.
Maximum output voltage	50 V rms
Maximum interference	50 V peak to peak

Continuity

Range	0.01 Ω to 1 k Ω (3 digits)
Accuracy	$\pm 3\%$ (± 2 digits)
Test Current	Up to 205 mA
Lead Null	< 10 Ω

Leakage current

Range	0.00 A to 2.00 A at 5% (+3 digits)
Accuracy	$\pm 5\%$ (± 3 digits)

Instrument specifications

Display	Backlit, colour, WQVGA display 5.25 in
Operating temperature	From -10 to 40 °C (14 to 104 °F)
Operating humidity	90% RH max at 40 °C
Storage temperature	From -20 to 60 °C (4 to 140 °F)
Temperature coefficient	< ±0.1% per °C over operating Temp.
Environmental protection	IP54 operational (lid open) IP65 storage (lid closed)
Altitude:	Up to 2000 m above sea-level.
Measurement connection rating	CAT IV 300 V (clamp terminals not isolated from measurement terminals)
Measurement output rating	±50 V 1 A, ac or dc.
Power supply	Internal Li-ion battery (rechargeable / replaceable) External 100 to 240 V ac, 50 - 60 Hz (with adaptor) External 18V dc supply (65 W)
Battery life	10 h. max. (typically)
Battery charge time	Fast recharge to 50%, 3 h for 100%.
Ambient temperature (battery charge)	0 - 40 °C
Safety	Meets IEC 61010
EMC	Meets IEC 61326
Dimensions	315 x 285 x 181 mm (13.8 x 11.2 x 7.1 in)
Weight	4.8 kg (10.6 lb)
PC data download	USB 2.0
Data Management	Internal 500 record storage
USB Host	Send data to pen drive
Resistivity calculation	Wenner Schlumberger
Tests	2P, 3P, ART (Selective), 4P, Stakeless (clamp) modes
Real time clock	Yes
RoHS compliant	Yes

Instrument calibration check tool

Electrical specification

Resistance	25 Ω ±0.1%
------------	------------

Mechanical specification

Dimensions	60 x 55 x 25 mm (2.5 x 2.25 x 1 in)
Weight	0.1 kg (0.2 lb) approximately

Clamp calibration check tool

Electrical specification

Resistance 25 Ω \pm 0.1%

Mechanical specification

Operating temperature -10 °C to 50 °C (14 °F to 122 °F)
0% to 85% RH at +35 °C (95 °F)
Storage temperature -20 °C to 70 °C (-4 °F to 158 °F)
Dimensions 111 x 216 x 45 mm (4.4 x 8.5 x 1.8 in)
Weight 0.1 kg (0.2 lb) approximately

Accessories

Warning: Use only Megger approved test leads and accessories with this instrument.

Item	Part Number
Cable reel kit ETK30	1010-176
Cable reel kit ETK50	1010-177
Cable reel kit ETK100	1010-178
Cable reel kit ETK50C	1010-179
Cable reel kit ETK100C	1010-180
Clamp MCC1010	1010-516
Clamp MVC1010	1010-518
12 V dc power lead	1004-183
Terminal adapter, detachable retro-fit for C1, P1, P2, C2 connectors	6220-803
Power supply 18 V >3.5 A	1010-793

Repair and warranty

If an instrument's protection has been impaired it should not be used, but sent for repair by suitably trained and qualified personnel. The protection is likely to be impaired if for example, it shows visible damage, fails to perform the intended measurements, has been subjected to prolonged storage under unfavourable conditions, or has been subjected to severe transport stresses.

New instruments are guaranteed for one year from the date of purchase by the user.

Note: Any unauthorized prior repair or adjustment will automatically invalidate the warranty and calibration.

Note: No user repair is possible beyond that which is described within this manual, i.e. battery replacement and cleaning. Any attempt to disassemble or repair beyond this point will invalidate any warranty on the item.

Calibration and repair

Megger operate fully traceable calibration and repair facilities to make sure your instrument continues to provide the high standard of performance and workmanship that is expected. These facilities are complemented by a worldwide network of approved repair and calibration companies, which offer excellent in-service care for your Megger products.

For service requirements for Megger Instruments contact:

Megger Limited	or	Megger
Archcliffe Road		Valley Forge Corporate Centre
Dover		2621 Van Buren Avenue
Kent		Norristown
CT17 9EN		PA 19403
England		U.S.A.
Tel: +44 (0) 1304 502 243		Tel: +1 610 676 8579
Fax: +44 (0) 1304 207 342		Fax: +1 610 676 8625

Return procedure

Warning: This instrument contains a lithium ion high energy battery pack.

UK and USA Service Centres

1. When an instrument requires recalibration, or in the event of a repair being necessary, a Returns Authorisation (RA) number must first be obtained from one of the addresses shown above.

The following information is to be provided to enable the Service Department to prepare in advance for receipt of your instrument and to provide the best possible service to you:

- Model (for example, DET2/3)
 - Serial number (found on the underside of the case or on the calibration certificate)
 - Reason for return (for example, calibration required, or repair)
 - Details of the fault if the instrument is to be repaired
2. Make a note of the RA number. A returns label can be emailed or faxed to you if required.
 3. Pack the instrument carefully to prevent damage in transit.
 4. Before the instrument is sent to Megger, freight paid, make sure that the returns label is attached, or that the RA number is clearly marked on the outside of the package and on any correspondence.

Copies of the original purchase invoice and packing note should be sent simultaneously by airmail to expedite clearance through customs. In the case of instruments which require repair outside the warranty period, an immediate quotation can be provided when obtaining the RA number.

5. Track the progress on line at www.megger.com.

Approved service centres

A list of Approved Service Centres can be obtained from the UK address above, or from Megger's website at www.megger.com

End of life

WEEE directive

The crossed out wheeled bin symbol placed on Megger products is a reminder not to dispose of the product at the end of its life with general waste.

Megger is registered in the UK as a Producer of Electrical and Electronic Equipment (registration No.: WEE/HE0146QT).

For further information about disposal of the product consult your local Megger company or distributor or visit your local Megger website.

Battery disposal

The crossed out wheeled bin symbol placed on a battery is a reminder not to dispose of batteries with general waste at the end of their life.

This instrument contains a rechargeable Li-ion battery, which is located under the battery cover at the bottom of the instrument. To remove the Li-ion battery follow the instructions in Battery (page 36).

A spent Li-ion battery is classified as an Industrial Battery. For disposal in the UK contact Megger Ltd.

For disposal of batteries in other parts of the EU contact your local Megger branch or distributor.

Megger is registered in the UK as a producer of batteries (registration No.: BPRN00142).

For Further information see www.megger.com

Declaration of conformity

Hereby, Megger Instruments Limited declares that radio equipment manufactured by Megger Instruments Limited described in this user guide is in compliance with Directive 2014/53/EU. Other equipment manufactured by Megger Instruments Limited described in this user guide is in compliance with Directives 2014/30/EU and 2014/35/EU where they apply.

The full text of Megger Instruments EU declarations of conformity are available at the following internet address: megger.com/eu-dofc

Bibliography

Getting Down to Earth, published by and available from Megger, Pt. No.: 21500-072.

Notes



Megger Limited
Archcliffe Road
Dover
Kent
CT17 9EN
ENGLAND
T +44 (0)1 304 502101
F +44 (0)1 304 207342

Megger GmbH
Obere Zeil 2 61440
Oberursel,
Germany
T. 06171-92987-0
F. 06171-92987-19

Megger USA - Valley Forge
Valley Forge Corporate Center
2621 Van Buren Avenue
Norristown
Pennsylvania,
19403 USA
T. 1-610 676 8500
F. 1-610-676-8610

Megger USA - Dallas
4271 Bronze Way
Dallas TX 75237-1019 USA
T 800 723 2861 (USA only)
T +1 214 333 3201
F +1 214 331 7399
USsales@megger.com

Megger AB
Rinkebyvägen 19, Box 724,
SE-182 17 Danderyd
T. 08 510 195 00
E. seinfo@megger.com

OTHER TECHNICAL SALES OFFICES

Toronto CANADA, Sydney AUSTRALIA, Madrid SPAIN and Mumbai INDIA.

Megger products are distributed in 146 countries worldwide.

This instrument is manufactured in the United Kingdom.

The company reserves the right to change the specification or design without prior notice.

Megger is a registered trademark

The Bluetooth ® word mark and logos are registered trademarks owned by Bluetooth SIG, Inc and is used under licence.