

EL-GFX-D2

Dual Channel Temperature, Humidity and Dew Point Data Logger with External Probe



FEATURES

- Dual channel Temp, RH and Dew Point data logger with external probe (supplied with x1 probe)
- -30 to +80°C (-22 to +176°F) and 0 to 100%RH measurement ranges
- Stores over 250,000 readings per channel for temperature and humidity
- Logging rates between 10 seconds and 1 hour
- On screen menu and graphing to start, stop, review and restart the logger in the field
- Triggered logging mode to start recording data once a user defined level is met
- User-programmable audible alarm thresholds with highly visible confidence/alarm LEDs
- Supplied with EasyLog software for Windows

This standalone data logger measures and stores over 250,000 temperature and humidity readings over a -30 to +80°C (-22 to +176°F) and 0 to 100%RH range at a resolution of 0.1°C (0.2°F) and 0.1%RH.

The user can easily set up the logger and view downloaded data by plugging the data logger into a PC's USB port and using the EasyLog USB software, free to download from www.lascarelectronics.com/software/easylog-usb. Data can then be graphed, printed and exported to other applications.

The data logger features a high contrast dot-matrix LCD and three buttons to navigate through an on-screen menu. This menu provides the user with access to real-time trend analysis, data summaries and the ability to start, stop and restart the data logger without the need to connect the data logger to the host-PC. Users can reset the maximum / minimum reading using the on-screen menu; this introduces an 'event marker' into the data which can later be viewed in the graphing software ('Mark Events' option) and the data file after download.

The data logger is supplied complete with two lithium metal batteries, which can typically allow logging for up to 1 year. It can also be powered from USB.

SPECIFICATIONS

Temperature	Measurement Range	-30°C to 80°C (-22°F to 176°F)
	Internal Resolution	0.1°C (0.2°F)
	Accuracy (logger error)	± 0.3°C (0.6°F) typical
Relative Humidity	Measurement Range	0 to 100%RH
	Internal Resolution	0.1%RH
	Accuracy (logger error)	± 2.05%RH typical (20 to 80%RH)
	Long Time Stability	0.5%RH / year
Dew Point	Accuracy (overall error)	± 1.1°C typical (±2.0°F)
Logging Rate	Between 10 seconds and 1 hour	
Battery Life*	1 year 2 x ½ AA 3.6V	
Dimensions of logger	101 x 48.5 x 30.5mm (3.98 x 1.91 x 1.20")	
Probe Dimensions	37 x 12 x 8mm (1.5 x 0.5 x 0.3")	
Cable Length	2000mm (79")	

* At 25°C and 10 minute logging rate with no alarm LEDs or sounder and minimal LCD use.

ACCESSORIES

EL-GFX-SP-2	Additional Probe to accommodate second channel
EL-GFX-SP-2+	Higher Accuracy Probe

INCLUDED IN THE BOX

EL-GFX-D2	Data Logger
EL-GFX-SP-2	1 X T/H Smart Probe
x2 BAT 3V6 1/2AA	Batteries
CABLE USB A-MICRO B	Micro USB cable
EL-GFX WALL BRACKET	Magnetic mounting bracket



EL-GFX-SP-2+ (Available at Additional Charge)

Temperature Resolution	0.01°C (0.02°F)
Temperature Accuracy	±0.2°C (±0.4°F) typical
Humidity Accuracy	±1.8%RH

EL-GFX-D2

Dual Channel Temperature, Humidity and Dew Point Data Logger with External Probe



Lascar's EasyLog USB control software is available to download from www.lascarelectronics.com/software. Easy to install and use, the control software runs under Windows™ 7/8/10 (32 & 64bit). The software is used to set-up the data logger as well as download, graph and export data to Excel. Each stored logging session is saved as a separate file.

The software allows the following parameters to be configured:

- Logger name
- Measurement parameter (°C or °F)
- Logging rate (customisable between 10 seconds and 1 hour)
- High and low temperature alarms on each channel
- Immediate, delayed, triggered and push-to-start logging
- Disable or enable LEDs and sounder with delayed activation
- Display off, on for 30 seconds after button press, or permanently on

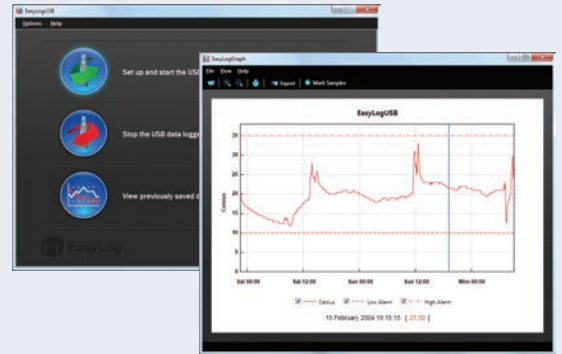

Download the latest version of the software free of charge from www.lascarelectronics.com/software

MENU BUTTON FUNCTIONS AND LCD SCREEN INDICATION

<p>ARMED! Press button to start logging</p> <p>DELAYED START Starts logging at 10:30:00 04/03/12</p> <p>DELAYED START Starts logging when temperature above 36.2°C</p>	<p>START LOGGER</p> <ul style="list-style-type: none"> • Loggers can be started immediately on a button press, delayed to a specific time or delayed to specific temperature reading 	<p>DISPLAY DATA</p> <p>26.8°C</p> <p>26.8°C</p> <ul style="list-style-type: none"> • Data can be displayed on screen in tabular or graphical format • You can switch between these views by pressing the gfx / txt buttons at the bottom-left of your screen 	
<p>ON-SCREEN ICONS</p> <p> When the EasyLog cube is shown in the top-left corner your logger is logging</p> <p> High/Low Alarm indicators are displayed at the top of your screen</p> <p> This icon indicates that your battery is low and will need to be replaced soon</p>			<p>STOP/START LOGGING & MUTE ALARM</p> <ul style="list-style-type: none"> • By pressing the button, you can stop your logger, or view logger settings. If you have already stopped logging, this option will change to 'Start Logging'. The audible alarm can be muted from this menu if enabled
<p>SUMMARY DATA</p> <p>Temperature: Max 34.8°C, Min 22.8°C</p> <p>Mem Used: 32%, Readings: 6336</p> <p>Since: 10:30 24/03/2012</p> <ul style="list-style-type: none"> • Summary screen displays max/min log and last log. Reset function clears summary if required • These screens can be reached by pressing the i button 		<p>LOCKED MODE</p> <p></p> <ul style="list-style-type: none"> • When in locked mode - an option during PC set-up - the logger can only be stopped and re-started using a PC loaded with the unit's configuration software 	
<p>LOGGER SETTINGS</p> <p>EasyLog USB Sample Rate 10s Low Alm 10°C High Alm 40°C S/N 000000001</p> <ul style="list-style-type: none"> • To view a summary of the logger's settings press the button, then click 'Logger Settings' 		<p>POP-UP MESSAGES</p> <p>Time & date not set Start unit logging using PC</p> <p>Memory is 90% full Download data to a PC to clear</p> <p>Memory full, logger stopped Download data to a PC to clear</p> <ul style="list-style-type: none"> • A message will overlay the screen - if there is an issue - the next time a button is pressed, e.g. if the logger is running low on memory 	

Please note that screens may vary slightly depending on model.

EL-GFX-D2

Dual Channel Temperature, Humidity and Dew Point Data Logger with External Probe



DIMENSIONS

All dimensions in mm (inches)

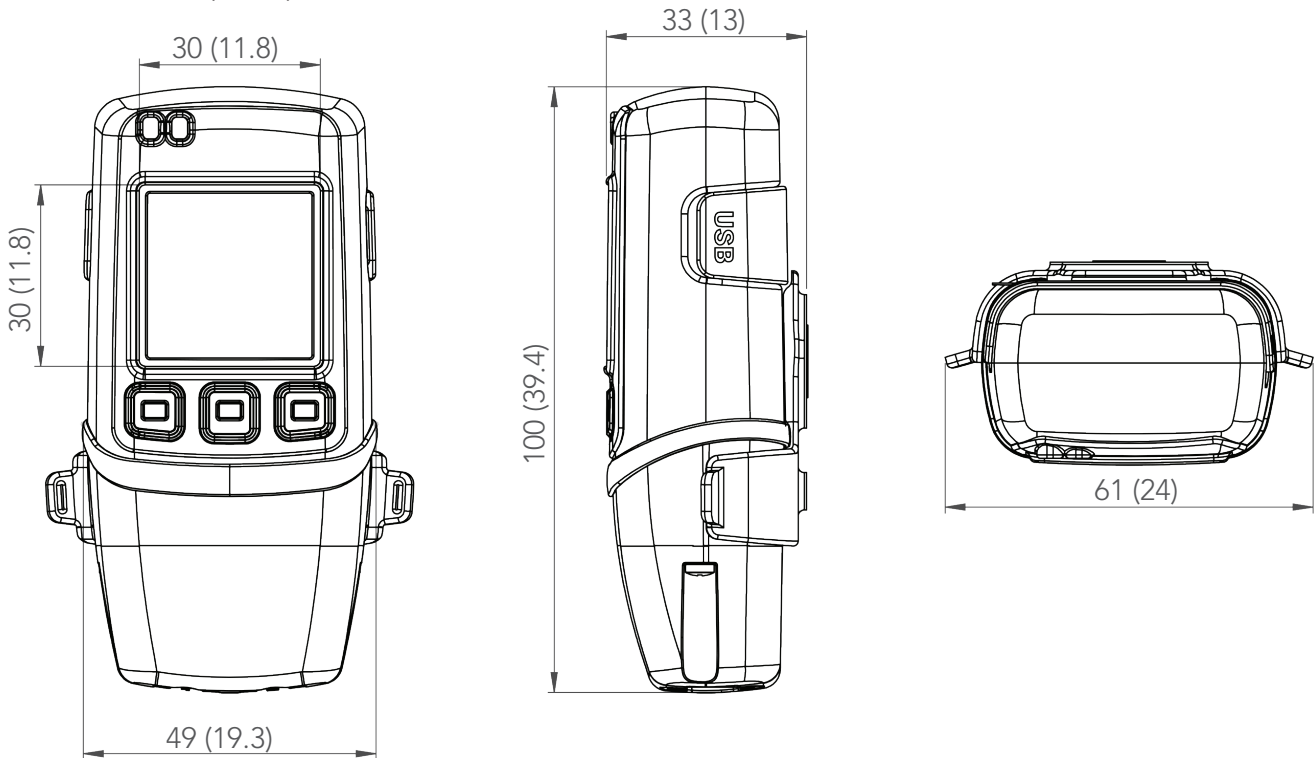

BATTERY INFORMATION

We recommend that you replace the batteries every 4 months, or prior to logging critical data.

Replacement

The EL-GFX-D2 does not lose its stored readings when the batteries are discharged or when the batteries are replaced; however, the data logging process will be stopped. If the batteries are changed within a 2 minute window the EL-GFX-D2 will retain its settings (internal clock and logging mode). This will allow logging to be restarted without additional connection to a PC via USB.

Only use 2 x 3.6V ½AA lithium batteries. Do not mix battery types and do not mix new and old batteries. Before replacing the batteries, unplug the EL-GFX-D2 from the PC.

Passivation

If left unused for extended periods of time, the Lithium batteries used in the EasyLog range of data loggers naturally form a non-conductive internal layer, preventing them from self-discharge and effectively increasing their shelf life. When first installed in the data logger, this may cause a momentary drop in the battery voltage (the Transient Minimum Voltage) as the internal layer is broken down, resulting in the data logger resetting. Inserting the batteries in the data logger and leaving it connected to a PC for about 30 seconds will remove this layer. After this, remove and re-install the batteries to reset the data logger. Overall battery life will not be affected.

WARNING

Handle lithium batteries carefully, observe warnings on battery casing. Dispose of in accordance with local regulations.

EL-GFX-D2

Dual Channel Temperature, Humidity and Dew Point Data Logger with External Probe



SENSOR ACCURACY & INFORMATION

TH probe = Sensirion, SHT21 accuracy graph (EL-GFX-SP-2)

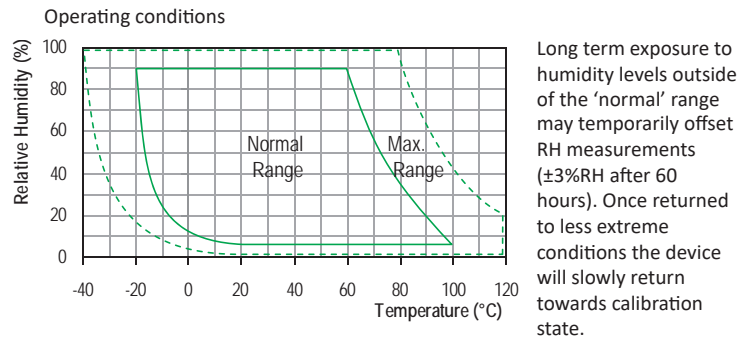
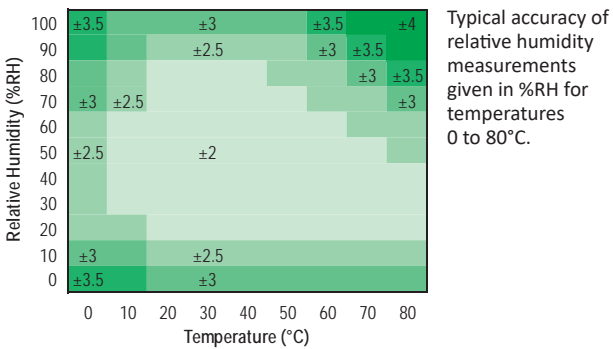
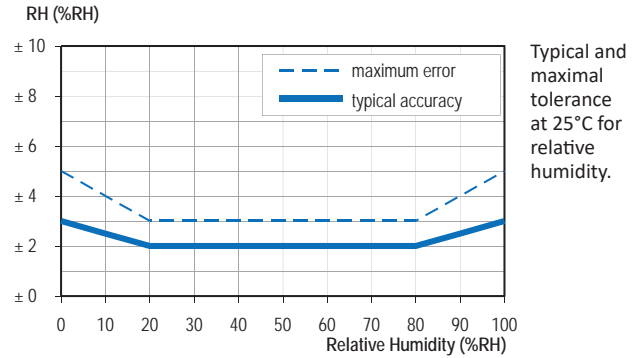
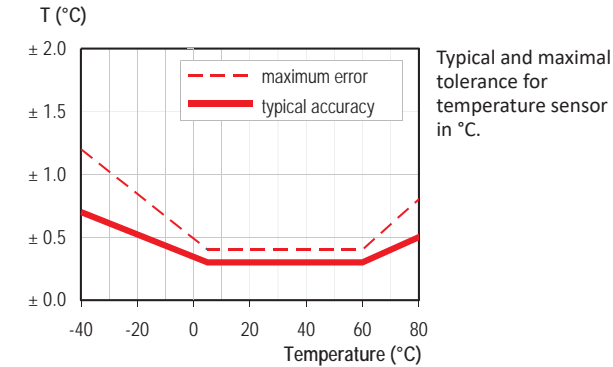

TH+ probe = Sensirion, SHT25 accuracy graph (EL-GFX-SP-2+)

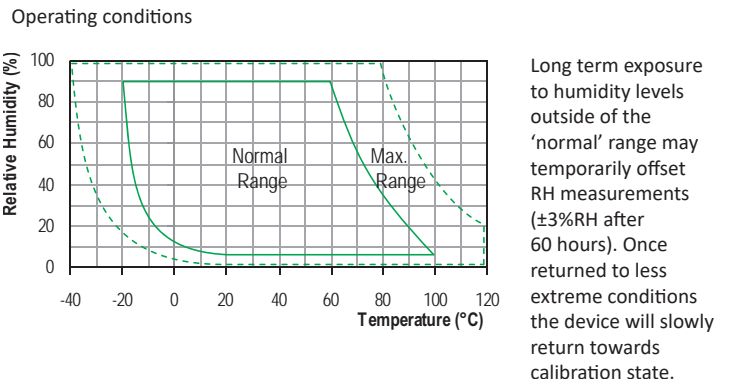
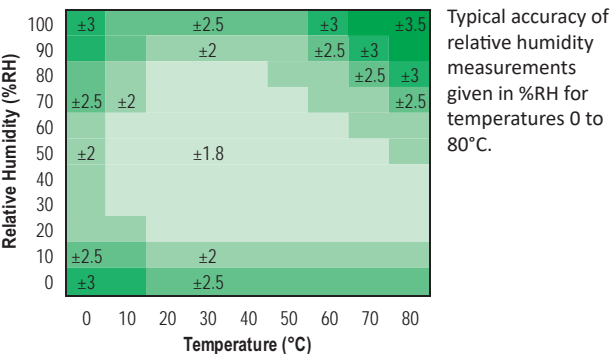
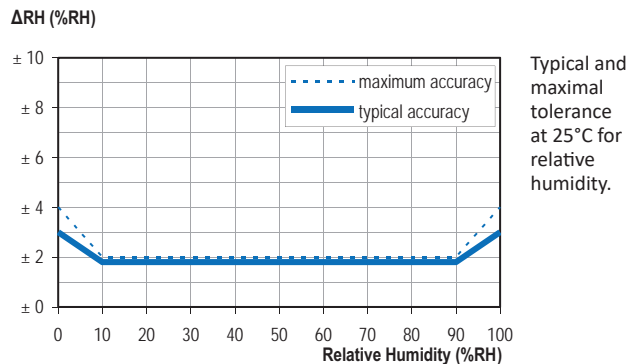
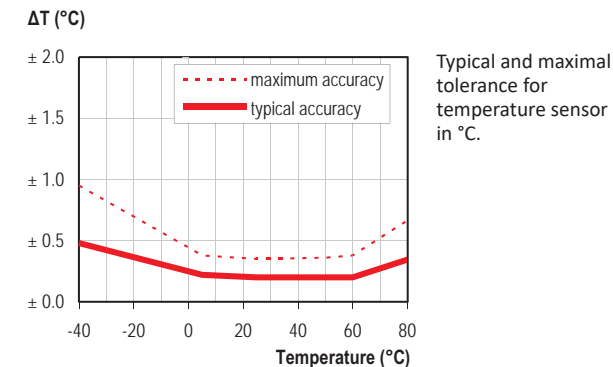

Contact:
 Industrial Process Measurement, Inc.
 3910 Park Avenue, Unit 7
 Edison, NJ 08820
 732-632-6400
 support@instrumentation2000.com
<http://www.instrumentation2000.com>

