



KANOMAX
The Ultimate Measurements

Micromanometer

Model 6700

Instruction Manual



Be sure to read this manual thoroughly before using the instrument ,
fully understand and pay attention to each cautions mentioned.
Please well-keeping this manual for long time service reference.



01003

15.05

CONTENTS

Product Configuration	3
Caution	4
1. Introduction	6
1.1. Features	6
1.2. Specifications	6
2. Outlook & Structure	6
3. Set tubg up	6
3.1. Micromanometer	6
3.2. Shoulder Strap	7
4. Operating Instruction	7
4.1. Power supply	7
4.2. Start On / Power Off	8
4.3. Keypad operation	8
5. Function test	9
5.1. User Interface	9
5.2. Single Mode	9
5.3. Average Mode	10
6. Menu setting	10
6.1. General setting	10
6.1.1. Date	10
6.1.2. Time	11
6.1.3. Auto Off	11
6.1.4. Backlighting	11
6.1.5. Communication	12
6.2. Test setting	13
6.2.1. Tools	13
6.2.2. ID application	13
6.2.3. Test Mode	14
6.2.5. Data record	14
7 Error and Troubleshooting	16
8 Warranty and Service	17

8.1. Product Warranty..... 17

8.2. After service..... 17

Product Configuration.

6700 Standard:

Item.	Qt'y
Micromanometer Model 6700	1
Carrying case	1
Pressure tubing	2
Communication cable	1
Calibration certificate	1
CD-Rom (Manual and software inside)	1
Quick-Guide	1
Shoulder Strap	1

6700 Optional Parts:

Item.	Specifications
Velocity Grid	
Pitot tube (2.3 x 200mm)	
Pitot tube (4 x 300mm)	
Pitot tube (8 x 500mm)	
Printer	
AC adapter	DC5V
International plug adapter	

Caution.

The symbols for warning mentioned in this manual are defined below:

(symbols classifications)

 **Danger:** To Prevent Serious Injury or Death

Warnings in this classification indicate a danger that may result in serious injury or death if not observed.

 **Caution:** To Prevent Damage to the Product

Warnings in this classification indicate a risk of damage to the product that may void the product warranty if not observed.

(Description of Symbols)











△ This symbol indicates a condition that requires caution (including danger). The subject of each caution is illustrated inside the triangle .

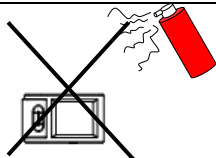

⊘ This symbol indicates a prohibition. Do not take the prohibited action shown inside or near this symbol.



● This symbol indicates a mandatory action. A specific action is given near the symbol.

 WARNING		
 Heated forbidden	<ul style="list-style-type: none"> ○ Never bring the fabric hood to a flammable gas atmosphere. ... otherwise, the heat may cause a fire or explosion. 	
 Disassemble prohibition	<ul style="list-style-type: none"> ○ Do not disassembly or refit the instrument. ... otherwise, may cause the electric shock or a fire. 	
 Using properly	<ul style="list-style-type: none"> ○ Using properly under the instruction manual. ... otherwise, may cause sensor damaged or an electric shock even a fire. 	
 Using properly	<ul style="list-style-type: none"> ○ If abnormal smells, noises or smoke occur, or if liquid enters the instrument, pull out the AC adapter and remove the batteries immediately. Then send it to the maintenance Dept. of KANOMAX for after service. ... or, there is possible of an electric shock or a fire or instrument malfunction. 	
 Forbidden	<ul style="list-style-type: none"> ○ Do not expose the fabric hood, base and the instrument noumenon in the rain. ... otherwise, may cause an electric shock, an fire and an person injure. 	

 **CAUTION**



Using properly

- Always unplug when the instrument not in use.
- … Failure to do so may cause an electric shock, an fire or circuit damage.



Using properly

- Remove the batteries when storing the instrument for a long period. Do not leave the exhausted batteries in the battery comparement and exchange the battereis on time.
- … Failure to do so may cause the batteries leakage and the instrument damage.



Using properly

- Matching the correct AC adapter outward as requested.
- … or may cause the instrument damage.



Forbidden

- Do not wipe the instrument with a volatile solvent.
- … the body may deform or deteriorate. Use a soft dry cloth to remove stains. If stains persist, soak the cloth in a neutral detergent and wipe the instrument with the soft cloth. Never use volatile solvents such as thinner or benzene.



Forbidden

- Do not use or leave the instrument in a high temperature, high humidity or dusty environment. Do not leave the instrument under direct sunlight.
- … otherwise, the instrument may not function properly out of the specified operating conditions or the inside components damaged.

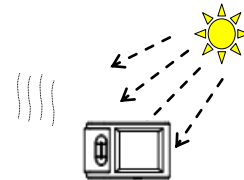

Forbidden

- Never dropping the unit or placing heavy objects on it
- … It may cause damage or malfunction to the instrument

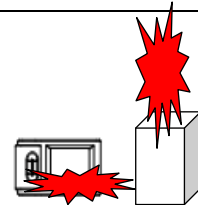

1. Introduction

Micromanometer Model 6700 is a high-accuracy intelligent test instrument.

1.1. Features

- ◆ 3.5 inch true color LCD.
- ◆ Ultra-large Storage capacity: 8000 records
- ◆ Blue tooth communication makes remote monitoring and data transferring available.
- ◆ Light weight, compact configuration for easy carrying.
- ◆ Data printing or transferring to the computer.

1.2. Specifications

Items		Specifications
Differential pressure	Test range	-2500~2500 Pa
	Accuracy	±1.5% of readings ±0.25Pa
	Resolution	0.001 Pa
Absolute pressure	Test range	70~130 kPa
	Accuracy	±2% of readings
	Resolution	0.1 kPa
Operation Temp.		0~60°C (non condensing)
Storage Temp.		-20~70°C (non condensing)
Power Source		4 pcs of AA-size battery (approx. 9hrs available) or DC5V Adapter
Weight		3.6kg approx.

2. Outlook & Structure

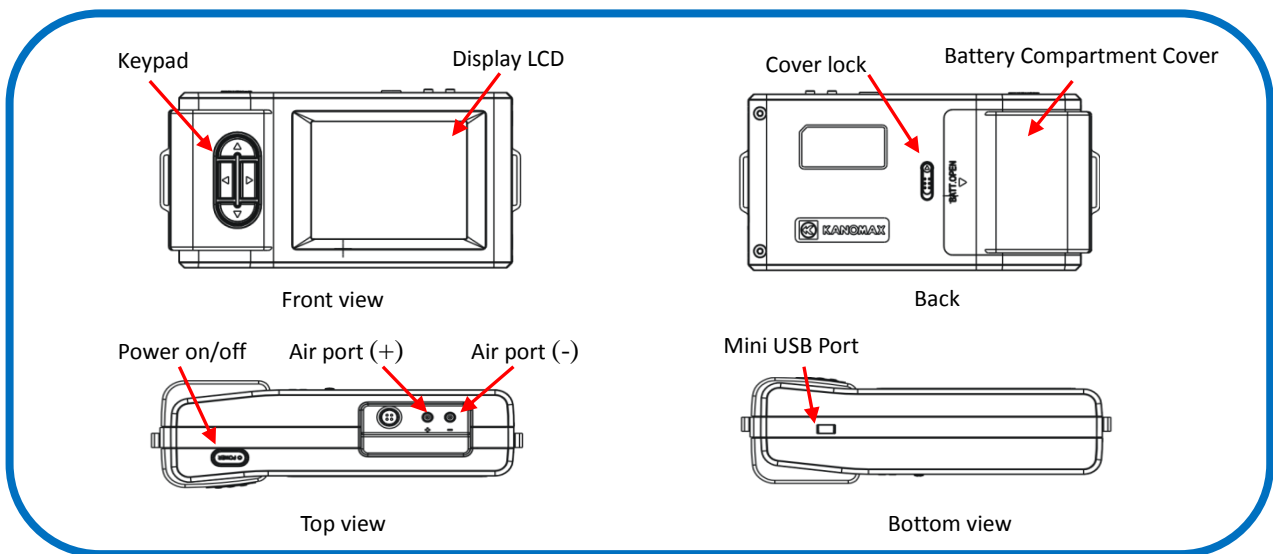

3. Setup up

3.1. Micromanometer

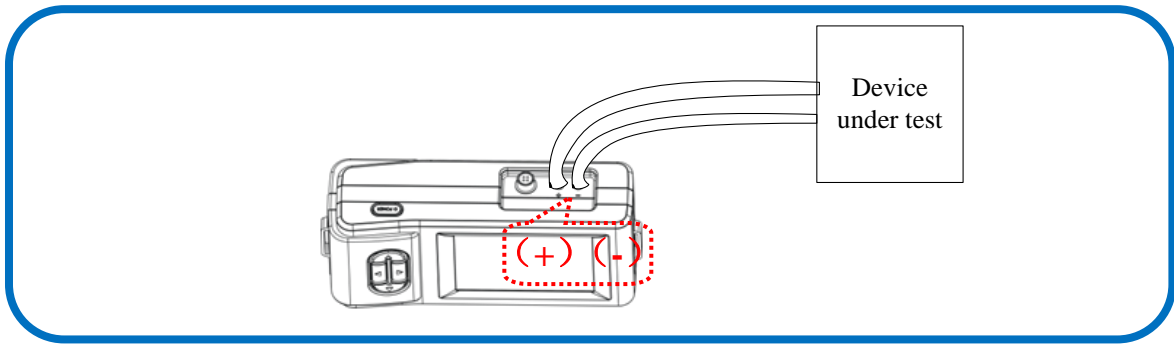

3.2. Shoulder Strap

For convenient view and easy operation, the shoulder strap can be fit for using.



4. Operating Instruction

4.1. Power supply

1. Power by AC adapter.

AC adapter will be as the priority power supply when the AC adapter and batteries are all available using. The specification of the AC adapter is: I/P:AC 110-240V 50/60HZ O/P:DC 5V/2A.

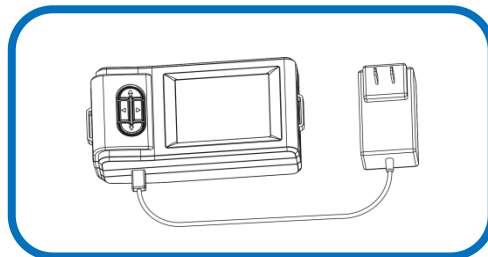

2. Power by battery

- ◆ 4 AA-size batteries can be used for a power supply.
- ◆ Press the compartment cover lock (refer to figure indicating ①/②), and then slide the cover off to open the battery compartment.

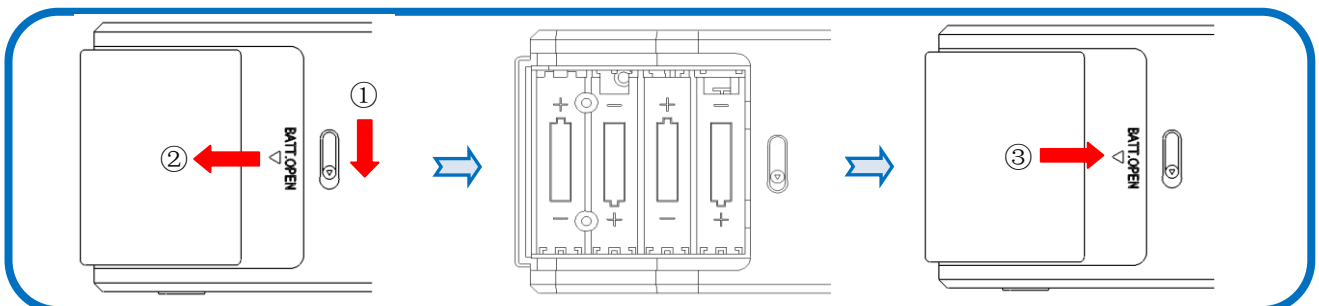

- ◆ Put 4 AA-size batteries in and make certain the batteries are correctly oriented.
- ◆ New alkaline battery or rechargeable Ni-MH battery can be used. Never mix battery types, or battery leakage or damage to the instrument may occur.
- ◆ Replace the compartment cover (refer to figure ③). The compartment cover will be automatically locked.
- ◆ When power is supplied with batteries, the current charge value will be displayed on the upper of the LCD. When the batteries run out of power, the instrument will turn off.

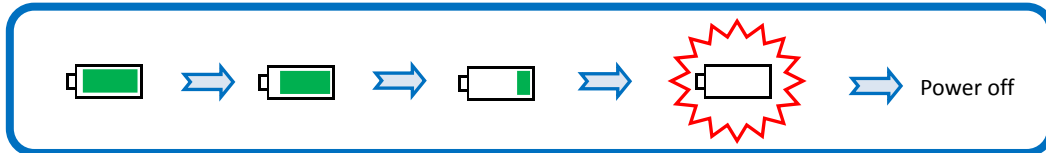

Note:

- 1) Do not test with low battery power.
- 2) Do not mixing use full power battery with low power ones for ensure testing well.
- 3) Change the batteries in time when power shows low for ensure testing well.

4.2. Start On / Power Off



1. Start On

Press button **【POWER】** for 2 seconds for start On, displaying “ KANOMAX” then enter into the testing interface.

2. Power Off

Press **【POWER】** for 2 seconds, shut down and power off.

4.3. Keypad operation

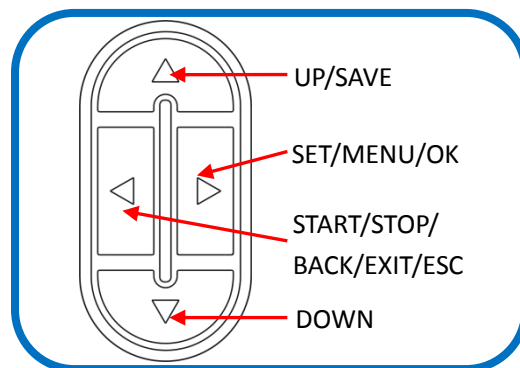

UP: Value increasing or Cursors upward moving.

SAVE: Save the current test results

SET: Store changes or enter into the selected option’s next level interface

MENU: On the main screen holding this down for 2 seconds will enter into the main “MENU”

OK: In the “General Setting”, pressing for 2 seconds will save the date or time ;

While in the “Record Processing”, pressing for 2 seconds will delete saved data.

START: Begin a measurement in main menu

STOP: Stop a measurement in main menu

BACK: Cancel or end an operation or return to the previous screen

EXIT: Return to the main menu

ESC: Stop printing when printing

DOWN: Value decreasing or Cursors downward moving

5. Function test

5.1. User Interface

Testing information, parameter settings and the testing conditions will be displayed on the main interface.

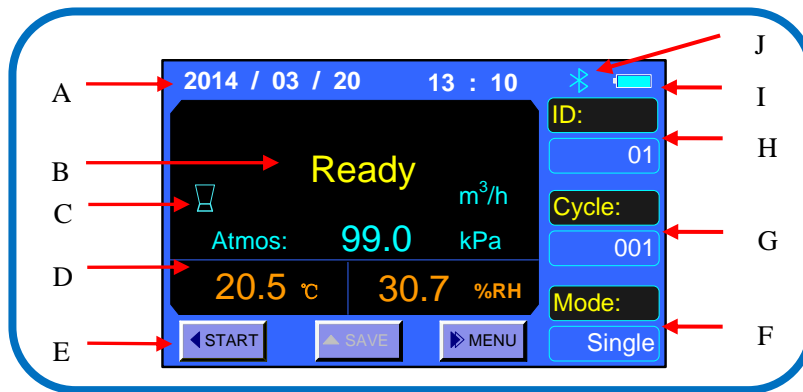

- A. Date and time —— real-time display the current date and time
- B. Testing data display —— differential pressure and etc.
- C. Tools icon —— working tools display
- D. Testing condition —— absolute pressure displaying
- E. Keypad —— current status indicating and the grey state is not available.
- F. Testing mode —— display the current testing mode
- G. Cycle —— recorded Cycle quantity
- H. ID —— current ID quantity
- I. Power supply —— AC adapter or batteries
- J. Blue tooth status —— when blue tooth working, the icon display or no icon display with closed.

5.2. Single Mode

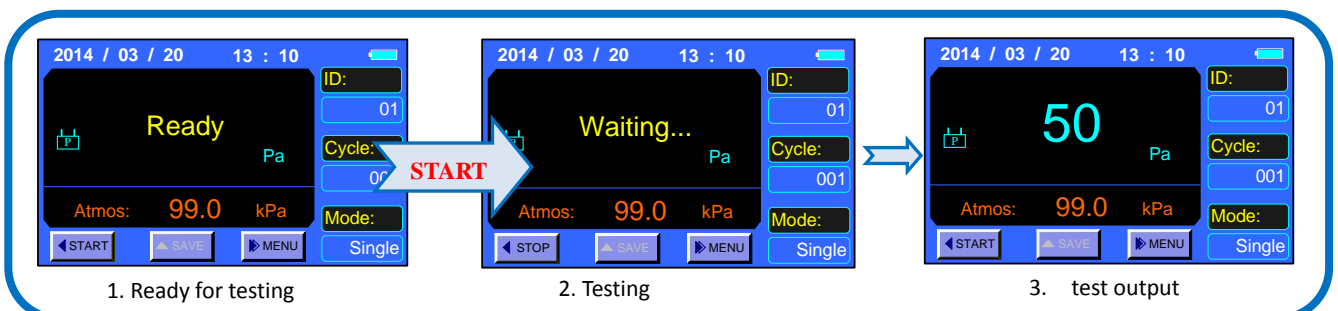

Note:

- 1) START: Left-button for the Micromanometer.
- 2) After testing start for about 8s with stably measuring, output displaying the test data and testing wind direction.
- 3) Testing stop when finish outputting.
- 4) Press SAVE for data record with adding 1 to the Cycle value.

5.3. Average Mode

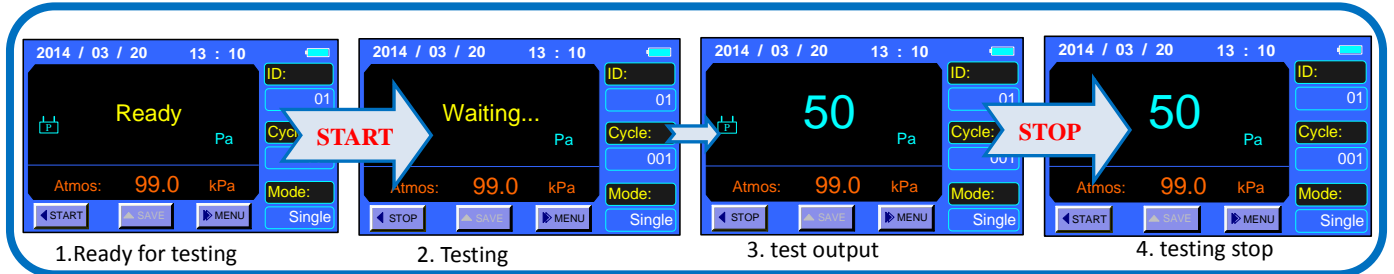

Note:

- 1) START: Left-button for the Micromanometer.
- 2) After testing start for about 8s with stably measuring , output displaying the test data for the first time.
- 3) Go on the testing with frequency of 1s for data updating.
- 4) The continuously outputting is as the average data and be related with the “AvgTime” set by user. More larger of the value of “AvgTime” will get more stable of the testing data.
- 5) If auto-save function On, testing data will be recorded automatically according to the setting “AutoSave” and value of “Cycle” will be added automatically.
- 6) Press “STOP”, testing stop. And “STOP” will be as the Left-button for the Micromanometer.

6. Menu setting

when stop for ready, press  for 2s for enter into the menu.

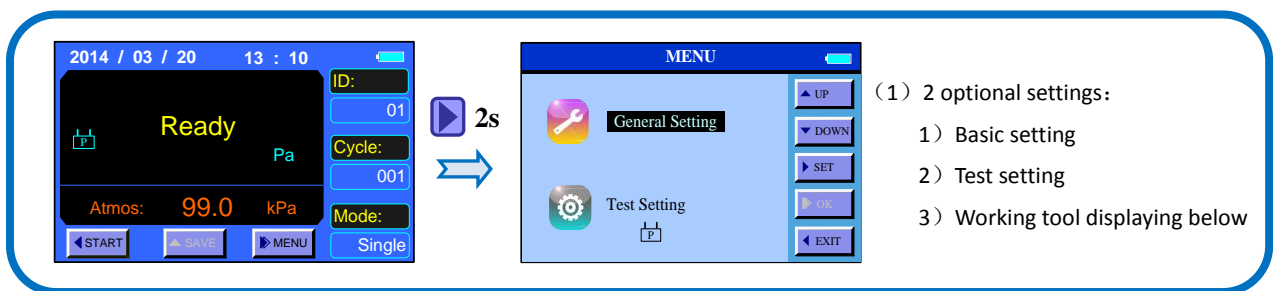

6.1. General setting

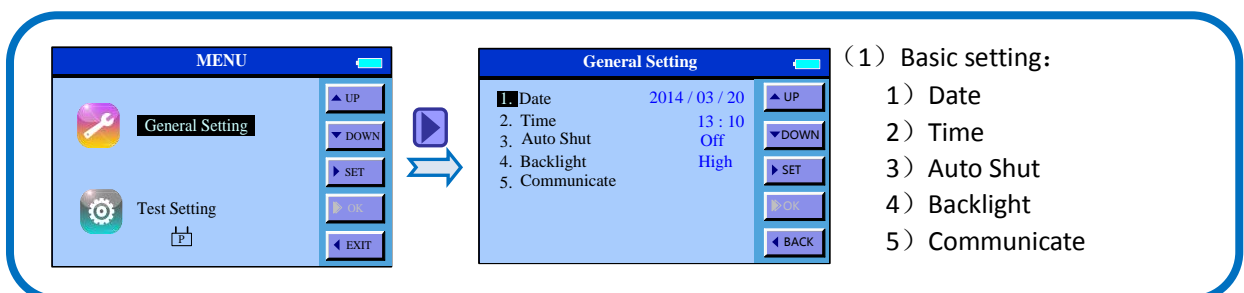

6.1.1. Date

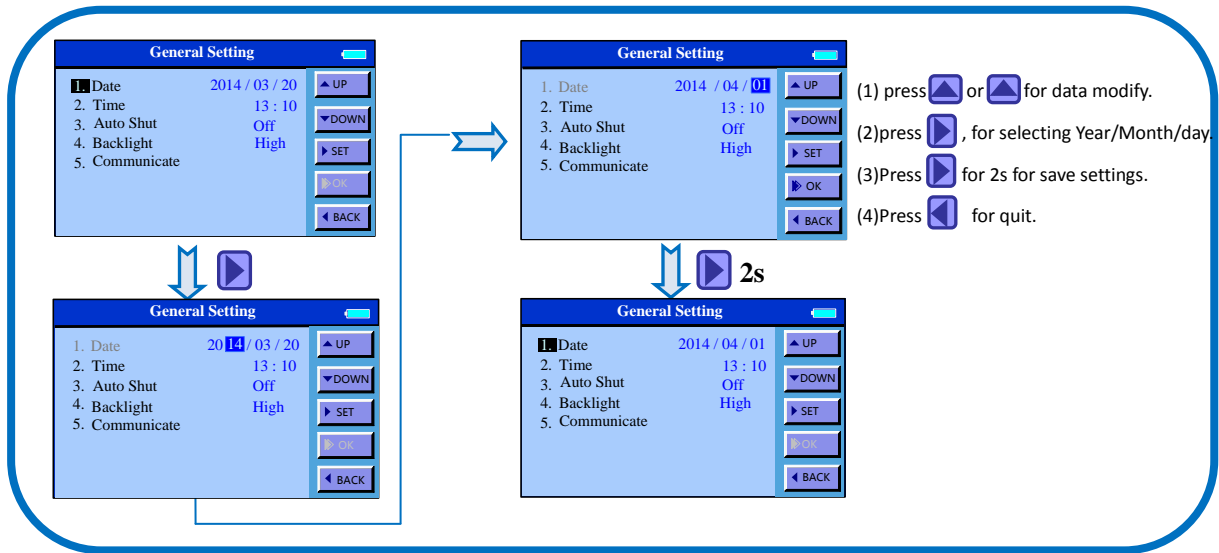

6.1.2. Time

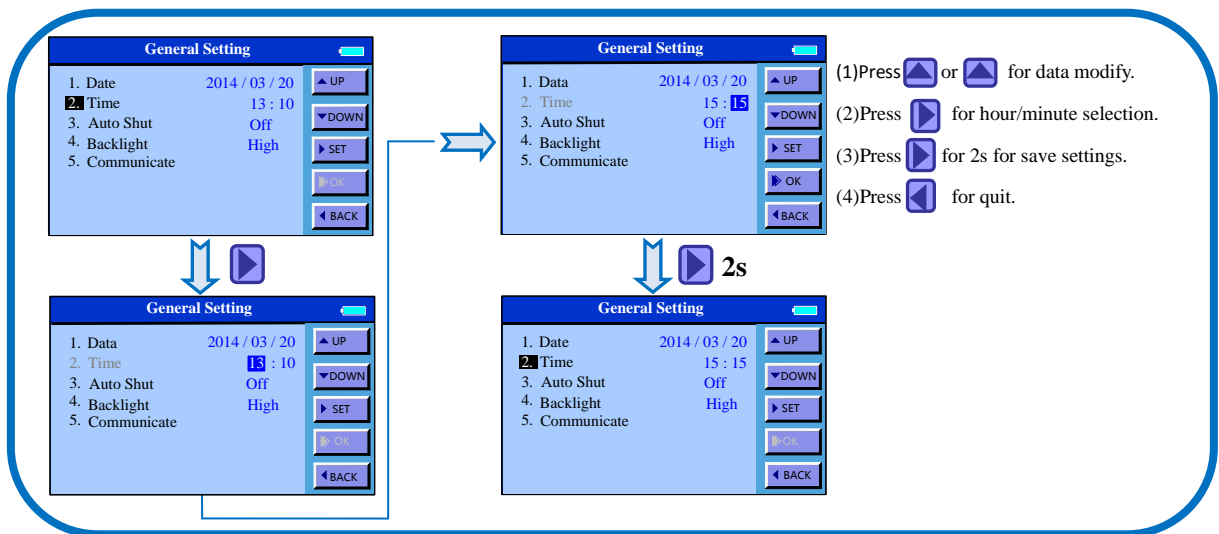

6.1.3. Auto Off

When instrument not in use, it will be turn off automatically according to Auto-Off time setting to avoid power waste.

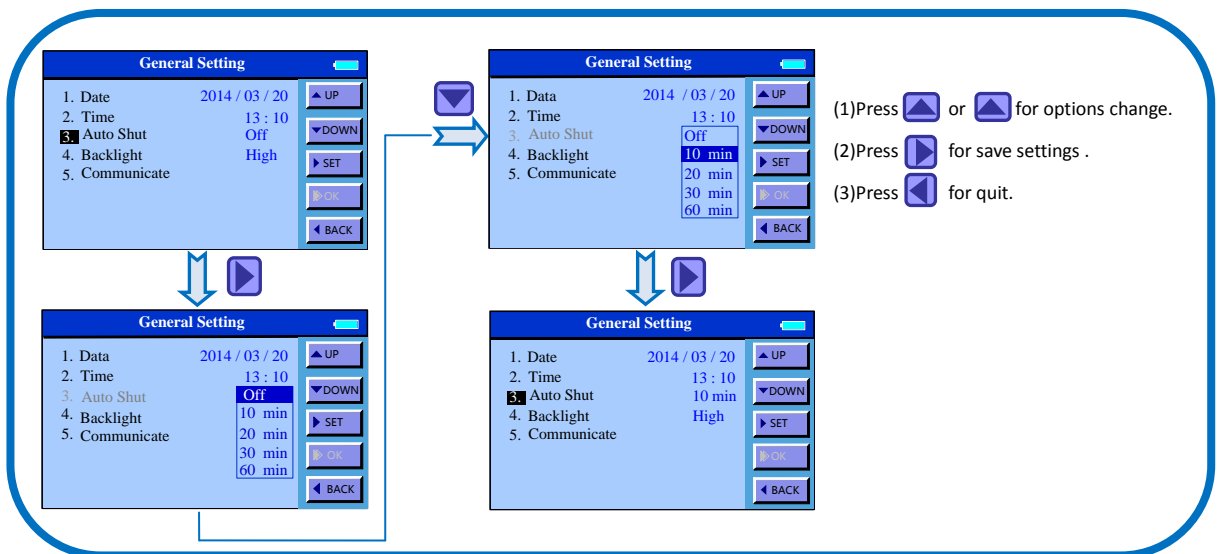

6.1.4. Backlighting

Adjust the LCD lighting according to the environmental brightness for the best viewing. And meanwhile, the

lower the brightness, the less battery power will be needed.

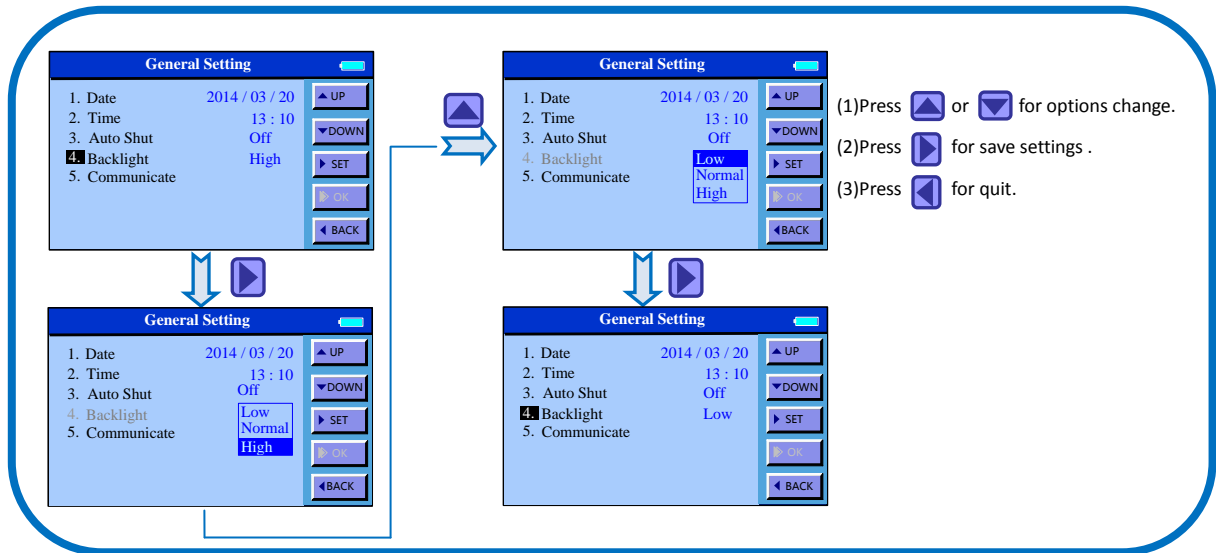

6.1.5. Communication

Communicate with PC, printer and Bluetooth are available. Data transfer or remote monitoring is available by selecting communicating way.

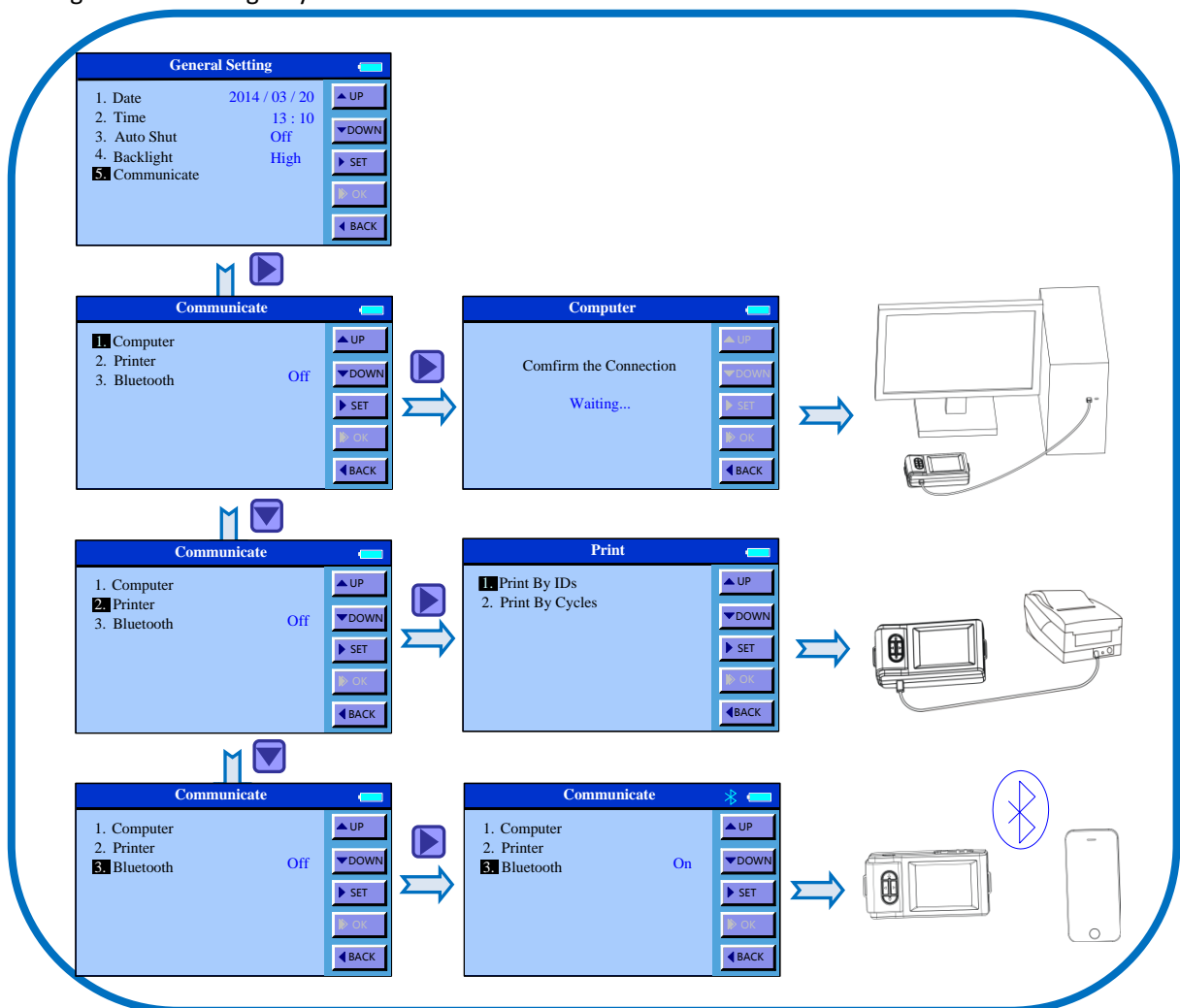

Note:

- 1) PC communication means to save the testing record to the computer. And the communication cable and software reserved for data-fetching are necessary for using together. Refer to the << Manual for Data

fetching Software>> .

- 2) For printing out the testing record, the optional printer and cables for special are necessary. Printer baud rate is set to 19200 bps and Do not change it. Refer to the << Manuel for RD series Mini printer >> .
- 3) Bluetooth make the remote control and data monitoring available by Hand phone. And our APP software is necessary for using together. Refer to the << Manuel for TAB Mobile>>.
- 4) Shut off the switch when not use the Bluetooth communication for improving battery life.
- 5) If other settings need to be changed when Bluetooth successful communication, you need to shutdown Bluetooth firstly then enter the menu to change other settings. Just as below shown:

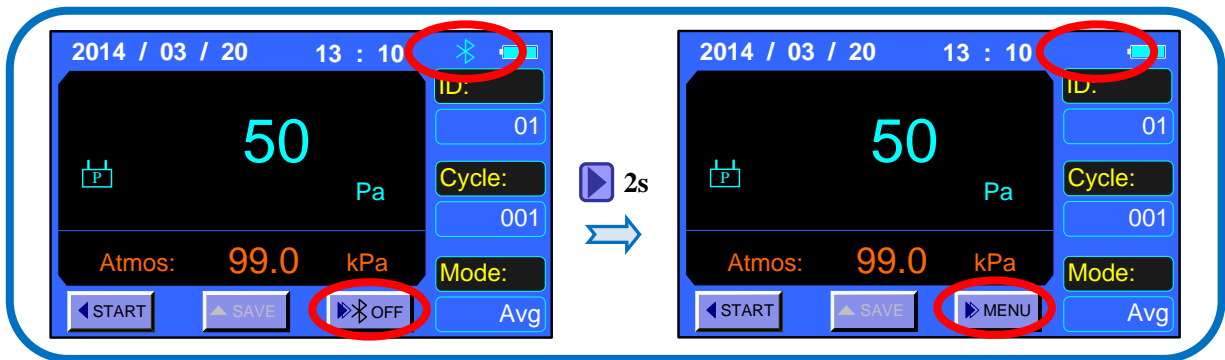

6.2. Test setting

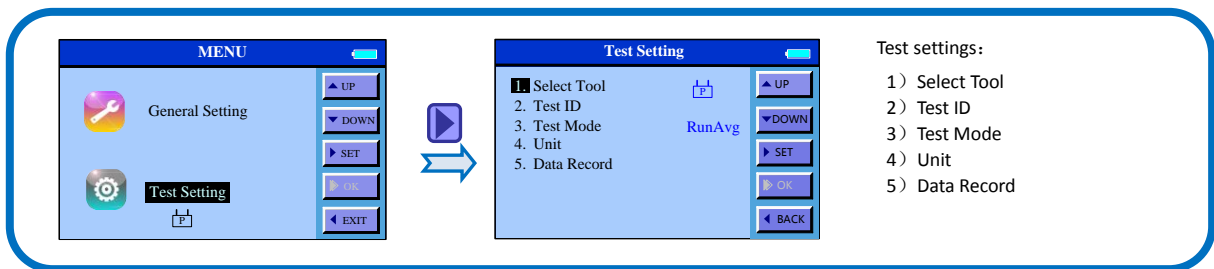

6.2.1. Tools

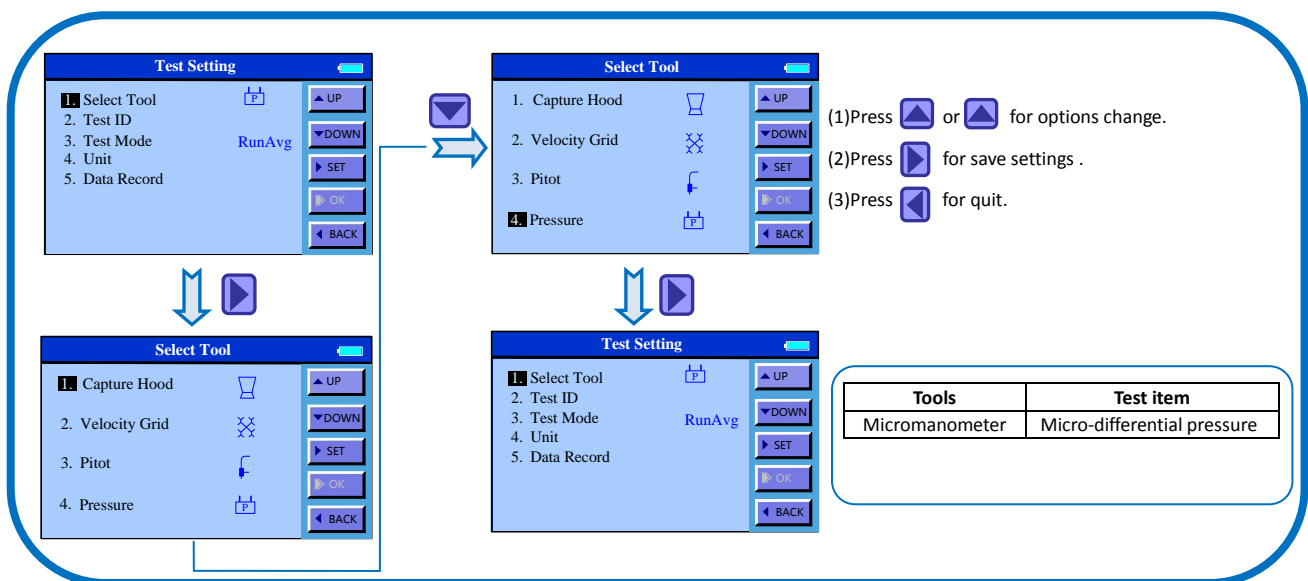

6.2.2. ID application

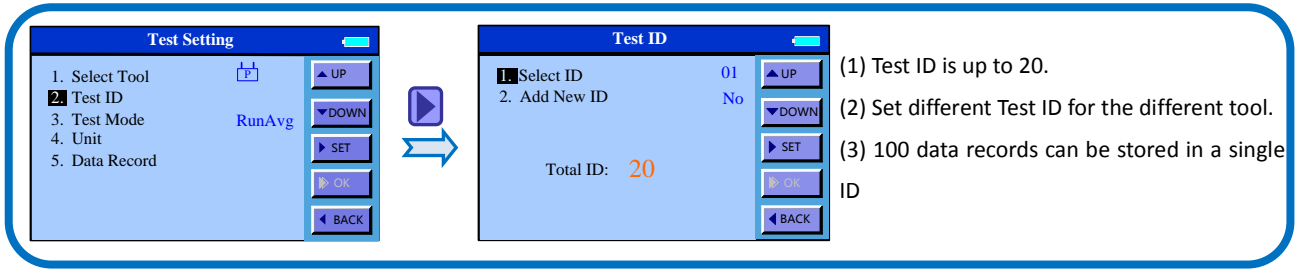

6.2.3. Test Mode

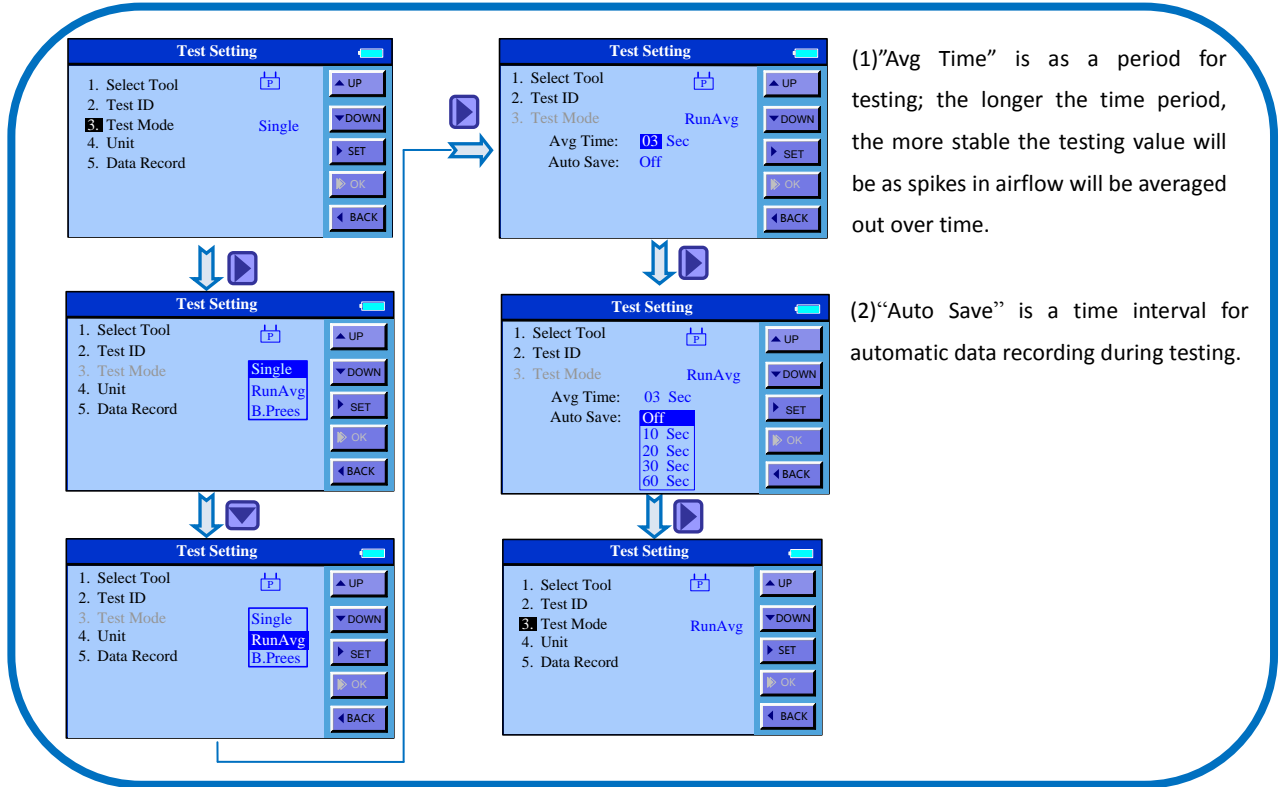

6.2.4. Units

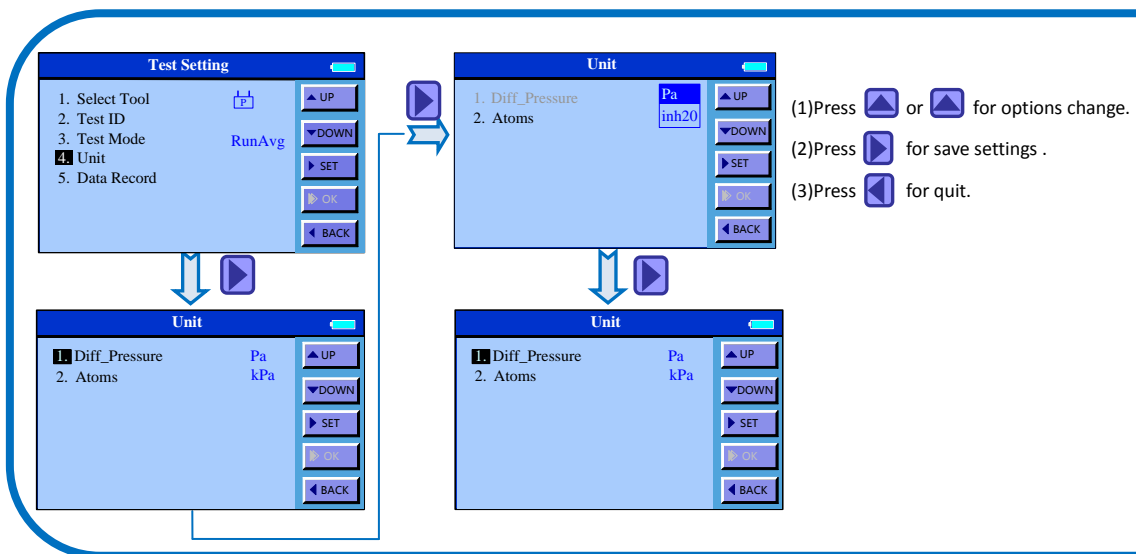

6.2.5. Data record

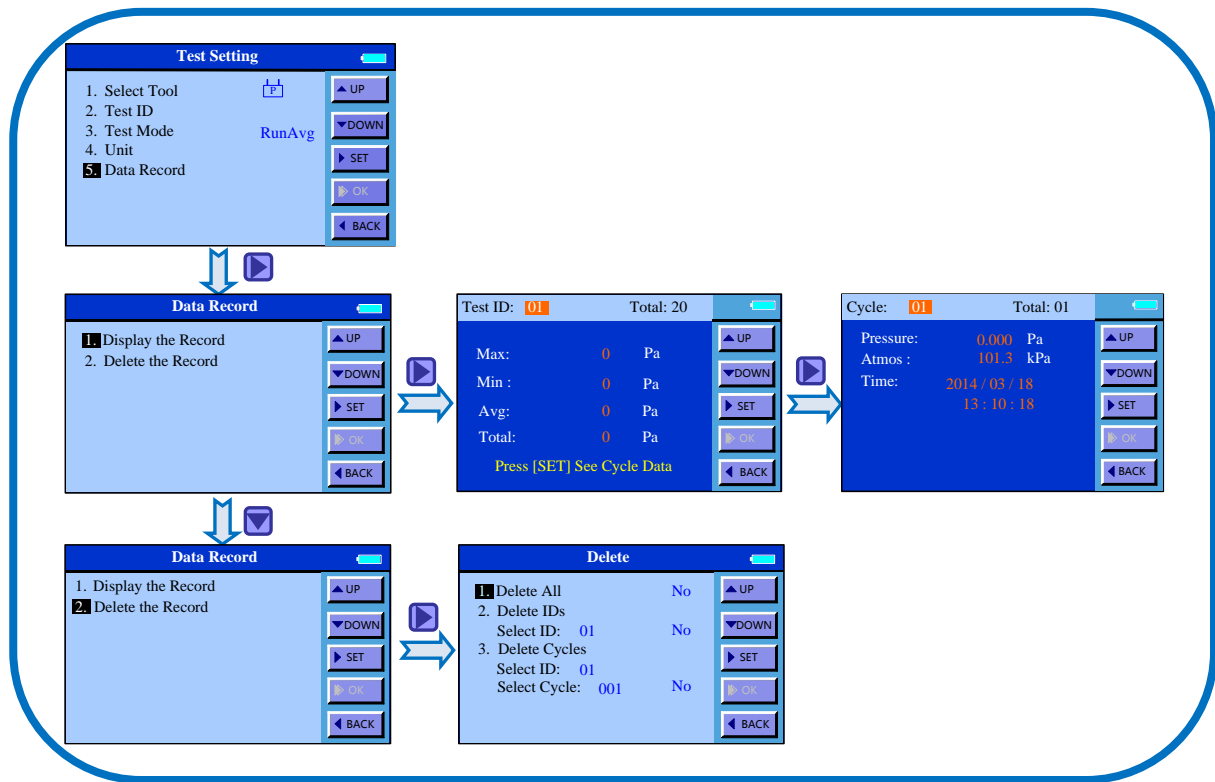

Note:

- 1) Browsing or deleting test data in current testing tools is available for allowed.
- 2) Data exporting by communication function and deleting the non-valid data in time for the effective storage space.
- 3) Pressing  for 2 seconds will delete saved data.

7 Error and Troubleshooting

Symptom	Possible causes	Corrective action
No display when power On	incorrect specification of the AC Adapter	Check and refer to Chapter4.1 in Manuel
	Battery installation error	Check and refer to Chapter4.1 in Manuel
	Low or dead battery power	Replace the batteries
Press "START" but no response	Low battery charge	Replace new batteries
	Back Pressure Plate opened On	Shut off the plate
Testing record can not be saved	Over-limit Cycle quantity in current ID	Add new ID or delete some data
New ID can not be added	ID over-limit	Delete some ID
	Current ID is without "Cycle"	Using the current ID
Printing unreadable code	Unmatched printer	Using our special optional printer supplied by us.
	Wrong baud rate setting	Reset referring to the Printer Manuel

8 Warranty and Service

8.1. Product Warranty

The limited warranty set forth below is given by KANOMAX GROUP COMPANIES with respect to the KANOMAX brand capture hood and other accessories (hereafter referred to as “PRODUCT”) purchased directly from KANOMAX GROUP COMPANIES or from an authorized distributor.

Your PRODUCT, when delivered to you in new condition in its original container, is warranted against defects in materials or workmanship as follows: for a period of one (1) year from the date of original purchase, defective parts or a defective PRODUCT returned to KANOMAX GROUP COMPANIES, as applicable, and proven to be defective upon inspection, will be exchanged for a new or comparable rebuilt parts, or a refurbished PRODUCT as determined by KANOMAX GROUP COMPANIES. Warranty for such replacements shall not extend the original warranty period of the defective PRODUCT.

This limited warranty covers all defects encountered in normal use of the PRODUCT, and does not apply in the following cases:

- (1) Use of parts or supplies other than the PRODUCT sold by KANOMAX GROUP COMPANIES, which cause damage to the PRODUCT or cause abnormally frequent service calls or service problems.
- (2) If any PRODUCT has its serial number or date altered or removed.
- (3) Loss of damage to the PRODUCT due to abuse, mishandling, alternation, improper packaging by the owner, accident, natural disaster, electrical current fluctuations, failure to follow operation, maintenance or environmental instructions prescribed in the PRODUCT's operation manual provided by KANOMAX GROUP COMPANIES, or service performed by other than KANOMAX GROUP COMPANIES.

NO IMPLIED WARRANTY, INCLUDING ANY IMPLIED WARRANTY OF MERCHANTABILITY OR FITNESS FOR A PARTICULAR PURPOSE, APPLIES TO THE PRODUCT AFTER THE APPLICABLE PERIOD OF THE EXPRESS LIMITED WARRANTY STATED ABOVE, AND NO OTHER EXPRESS WARRANTY OR GUARANTY, EXCEPT AS MENTIONED ABOVE, GIVEN BY ANY PERSON OR ENTITY WITH RESPECT TO THE PRODUCT SHALL BIND KANOMAX GROUP COMPANIES. KANOMAX GROUP COMPANIES SHALL NOT BE LIABLE FOR LOSS OF STORAGE CHARGES, LOSS OR CORRUPTION OF DATA, OR ANY OTHER SPECIAL, INCIDENTAL OR CONSEQUENTIAL DAMAGES CAUSED BY THE USE OR MISUSE OF, OR INABILITY TO USE, THE PRODUCT, REGARDLESS OF THE LEGAL THEORY ON WHICH THE CLAIM IS BASED, AND EVEN IF KANOMAX GROUP COMPANIES HAS BEEN ADVISED OF THE POSSIBILITY OF SUCH DAMAGES. IN NO EVENT SHALL RECOVERY OF ANY KIND AGAINST KANOMAX GROUP COMPANIES BE GREATER IN AMOUNT THAN THE PURCHASE PRICE OF THE PRODUCT SOLD BY KANOMAX GROUP COMPANIES AND CAUSING THE ALLEGED DAMAGE. WITHOUT LIMITING THE FOREGOING, THE OWNER ASSUMES ALL RISK AND LIABILITY FOR LOSS, DAMAGE OF, OR INJURY TO THE OWNER AND THE OWNER'S PROPERTY AND TO OTHERS AND THEIR PROPERTY ARISING OUT OF USE OR MISUSE OF, OR INABILITY TO USE, THE PRODUCT NOT CAUSED DIRECTLY BY THE NEGLIGENCE OF KANOMAX GROUP COMPANIES. THIS LIMITED WARRANTY SHALL NOT EXTEND TO ANYONE OTHER THAN THE ORIGINAL PURCHASER OF THE PRODUCT, OR THE PERSON FOR WHOM IT WAS PURCHASED AS A GIFT, AND STATES THE PURCHASER'S EXCLUSIVE REMEDY.

8.2. After service

- ◆ When you have a problem with your instrument, please check out the “Common Trouble Shooting” section first.
- ◆ If that does not help, please contact your local distributor, or contacts on the last page.
- ◆ During the warranty period, we will repair at no charge a product that proves to be defective due to material or workmanship under normal use. (See Section 14.1 Warranty)
 - All return shipping charges are the responsibility of the customer.

- ◆ Repair after warranty expiration:
 - Upon request, we will repair the instrument at the customer's expense, if the instrument's performance is found to be recoverable by providing the repair.
- ◆ Replacement parts are available for a minimum period of five (5) years after termination of production. This storage period of replacement parts is considered as the period during which we can provide repair service. For further information, please contact your local distributor, or contacts on the last page.

When making an inquiry, please provide the following information:

- * PRODUCT NAME -----
- * Model No. -----
- * Serial No. -----
- * Description of the problem : -----
- * Data of Purchase: Day, Month and Year



KANOMAX
The Ultimate Measurements

Kanomax Group Companies

■ Americas, Europe, Mid-East, Africa, Oceania

KANOMAX USA, INC.

219 US Highway. 206, Andover, New Jersey 07821

TEL: 1-800-247-8887(USA) / 1-973-786-6386

FAX: 1-973-786-7586

URL: www.kanomax-usa.com

E-Mail: info@kanomax-usa.com

■ Japan & Asia

KANOMAX JAPAN, INC.

2-1 Shimizu Suita City, Osaka Japan 565-0805

TEL: 81-6-6877-0183

FAX: 81-6-6879-2080

URL: www.kanomax.co.jp

E-Mail: sales@kanomax.co.jp

■ China

Shenyang Kano Scientific Instrument Co., Ltd.

#2610, 51 Wulihe Street Heping District, Shenyang City, PRC

TEL: 86-24-23845309

FAX: 86-24-23898417

URL: <http://www.kanomax.com.cn/>

E-Mail: sales@kanomax.com.cn