

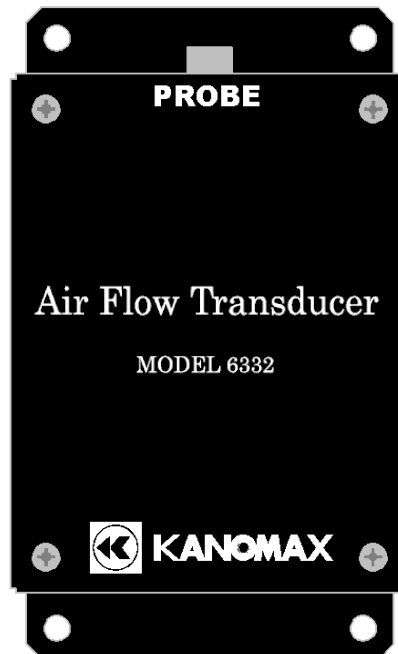

KANOMAX

AIR FLOW TRANSDUCER MODEL 6332/6332D

Operation Manual



Please read this manual carefully and understand the warnings described in this manual before operating the product.

Keep this manual handy for ready reference

KANOMAX JAPAN, INC.



02001

0809

Thank you for purchasing a product of Kanomax, Inc.

Please read this operation manual carefully and operate the instrument appropriately by following the instructions given in this manual.

Component List

■ Standard

Item	Model	Remarks
Airflow Transducer Main Unit (Without Display)	6332	—
Airflow Transducer Main Unit (With Display)	6332D	—

■ Probe & Cable (Sold Separately)

Item	Model	Remarks
Air Velocity Probe	0962-00	Uni-directional
	0963-00	
	0964-01	Omni-directional (Needle)
	0964-02	
	0965-00	Omni-directional (Spherical)
	0965-01	
	0965-03	Mini-temperature-compensation-sensor integrated type Omni-directional (Spherical)
	0965-04	
	0965-07	Mini-temperature-compensation-sensor independent type Omni-directional (Spherical)
	0965-08	
Probe Cable	1504-04	Length: 10m
	1504-05	Length: 20m
	1504-06	Length: 30m

■ Optional Accessory

Item	Model	Remarks
Display Unit	6332-01	—
AC Adapter	6332-02	—

Important Safety Information

In this operation manual, warning types and classifications are defined as follows.

[Classifications]



Danger: To Prevent Serious Injury or Death

Warnings in this classification indicate danger that may result in serious injury or death if not observed.



Caution: To Prevent Damage to the Product

Warnings in this classification indicate risks of damage to the product that may void the product warranty if not observed.

[Description of Symbols]



- △ This symbol indicates a condition (including danger) that requires caution. The subject of each caution is illustrated inside the triangle (e.g., high temperature caution symbol shown on the left).



- ⊘ This symbol indicates prohibition. Do not take a prohibited action shown inside or near this symbol (e.g., disassembly prohibition symbol shown on the left).



- This symbol indicates a mandatory action. A specific action is given near the symbol.

Danger



Do not use near flammable gas

○ **Never bring the probe close to a flammable gas atmosphere.**

--- The heated sensor may cause fire or explosion.

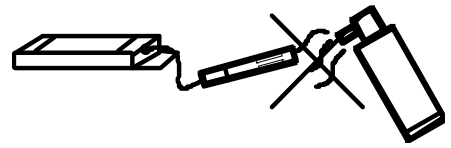

Do not modify / disassemble

○ **Never disassemble, modify or repair the instrument.**

--- Failure to observe the above may cause short circuit and malfunction.

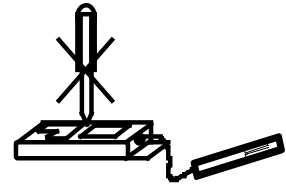

Do not use unspecified voltage

○ **Use the specified voltage for power supply.**

--- Unspecified voltage may cause electrical shock and fire.

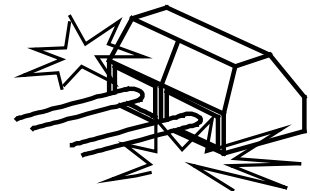

Handle Properly

○ **Remove dust and any impurities from the terminal block.**

--- The dust/impurities may cause fire.

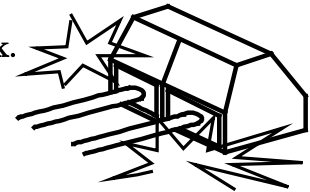

Prohibition

○ **Do not use the instrument in a water vapor atmosphere.**

--- Failure to observe the above may cause electrical shock, fire, or damage to the sensor.

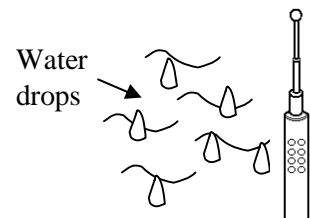

Warning:
High Temperature /
Injury

○ **Never touch the sensor.**

--- The sensor is heated during operation. Touching the heated sensor may cause burns, and also may damage the sensor itself. Particular attention must be paid to spherical type sensors (Model: 0965-00/ 0965-01/ 0965-03/ 0965-04/ 0965-07/ 0965-08) as they are very sensitive. Please Handle with care.

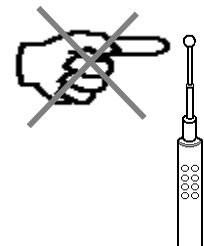

Caution



Prohibited
Installation

- Do not use or leave the instrument in a high temperature/humidity environment, or in a dusty environment. The instrument must also not be left under direct sunlight for a prolonged period.

--- The instrument may not function properly outside the specified temperature range of 5 to 40 degrees C.

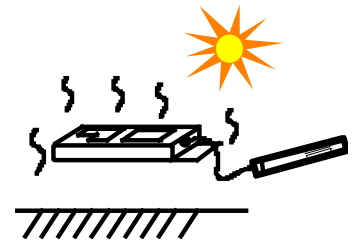

Prohibition

- Do not wipe the instrument with a volatile solvent.

--- The body may deform or deteriorate. Use soft dry cloth to remove stains. If stains persist, soak the cloth in a neutral detergent and wipe the instrument with the soft cloth.
Never use volatile solvents such as thinner and benzene.



Prohibition

- Do not apply strong shock to the instrument and probe.

--- Applying strong shock may cause damage and malfunction to the instrument and probe.

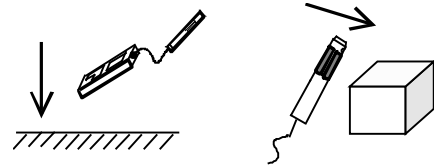
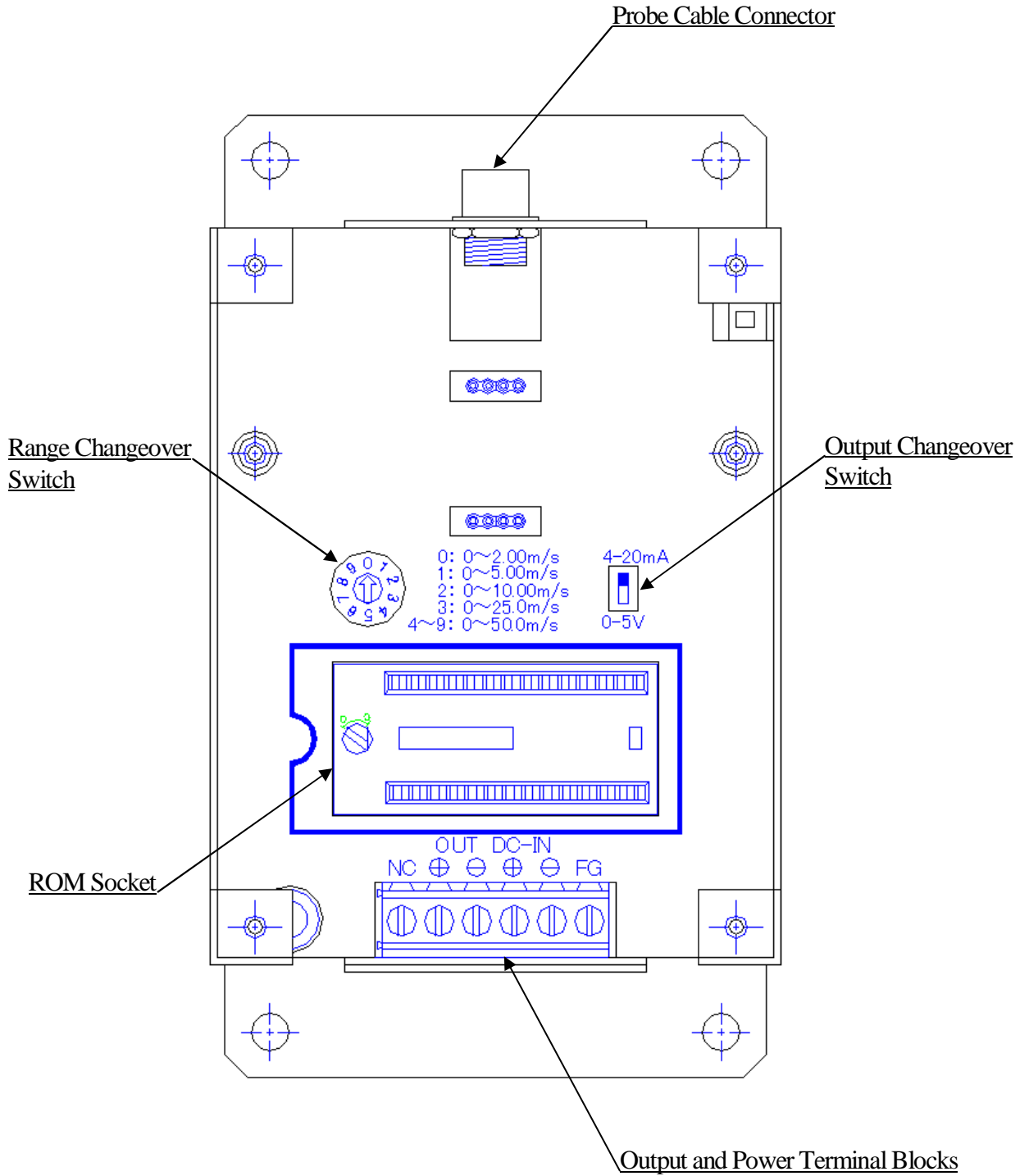

Table of Contents

◆ Names and Dimensions of Components	1
◆ System Configuration Example	5
◆ Connecting the Probe Cable to the Main Unit	6
◆ Connecting the Probe Cable to the Probe	6
◆ Installing the Data ROM	7
◆ Switching Output (Setting Current/Voltage and Output Range)	8
◆ Connecting Output and Power Supply	10
◆ Measurement Method	11
◆ Optional Accessory	12
Display Unit	12
AC Adapter	13
◆ Cleaning the Probe	14
◆ Specification of Main Unit	15
◆ Specification of Probes (Sold Separately)	16
◆ Troubleshooting	18
◆ Product Warranty and After Service	19
◆ Contact Information	20

Names and Dimensions of Components

(1) Model 6332 View inside the Case



(2) Model 6332D View inside the Case

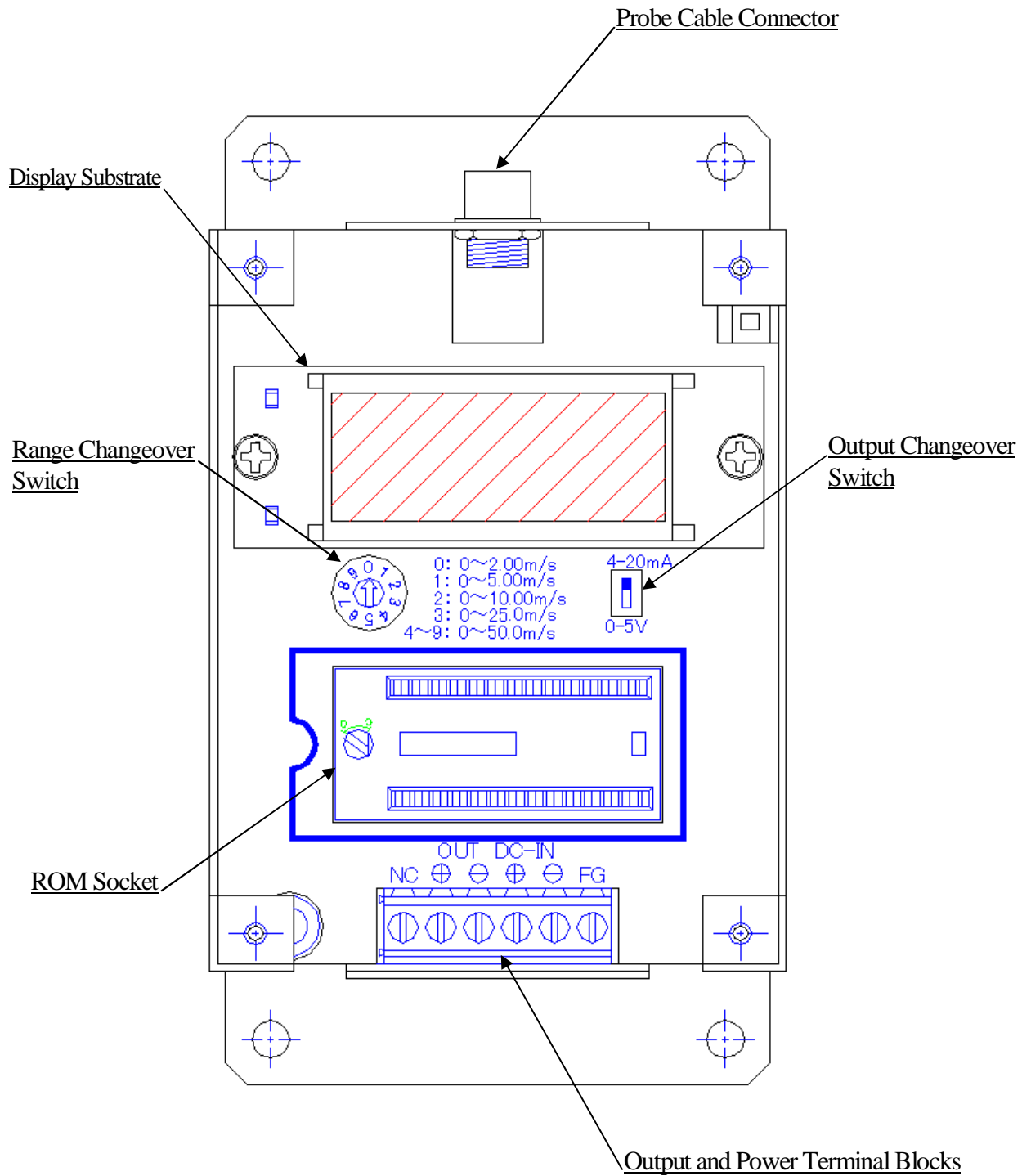

(3) Model 6332 View with the Case

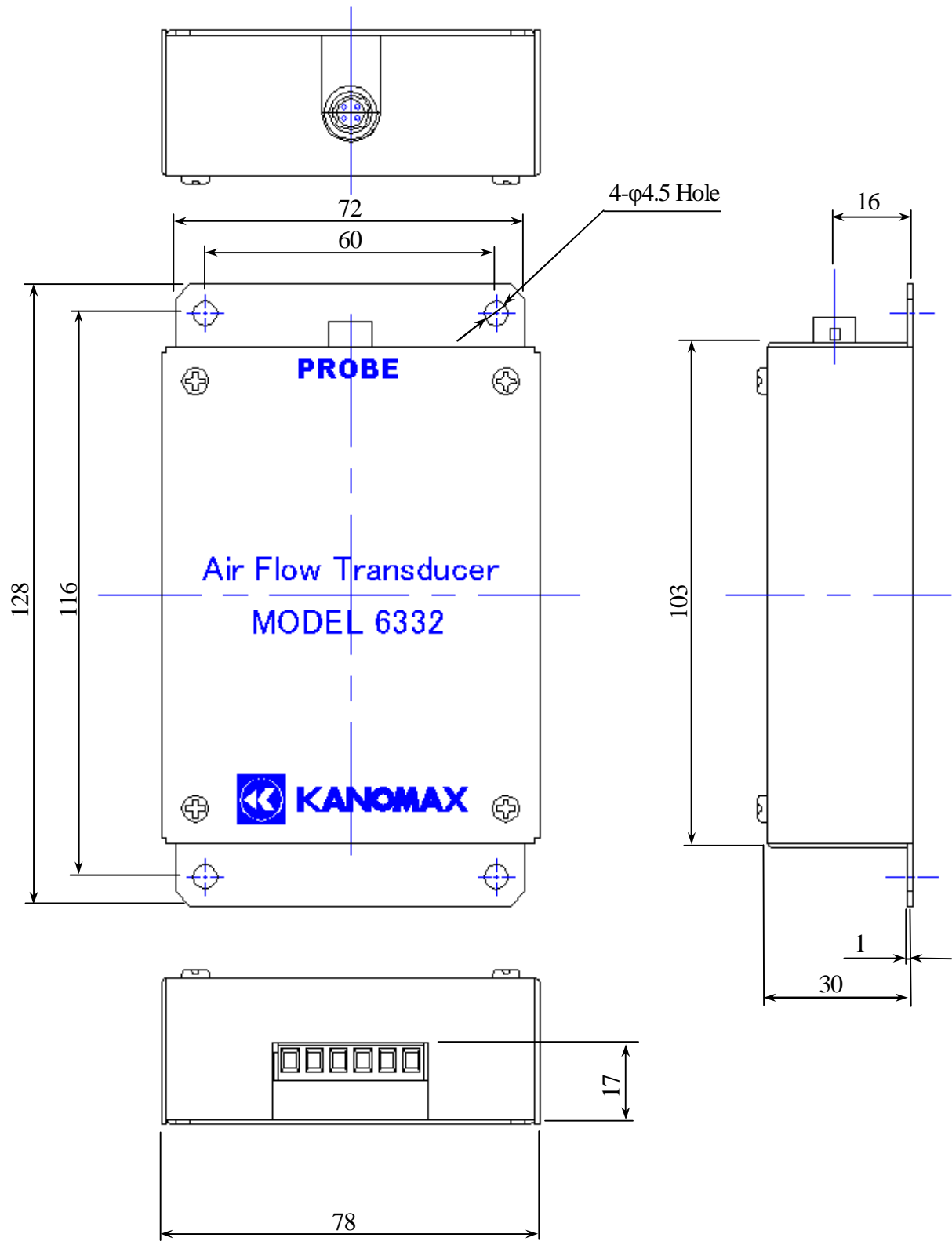

(4) Model 6332D View with the Case

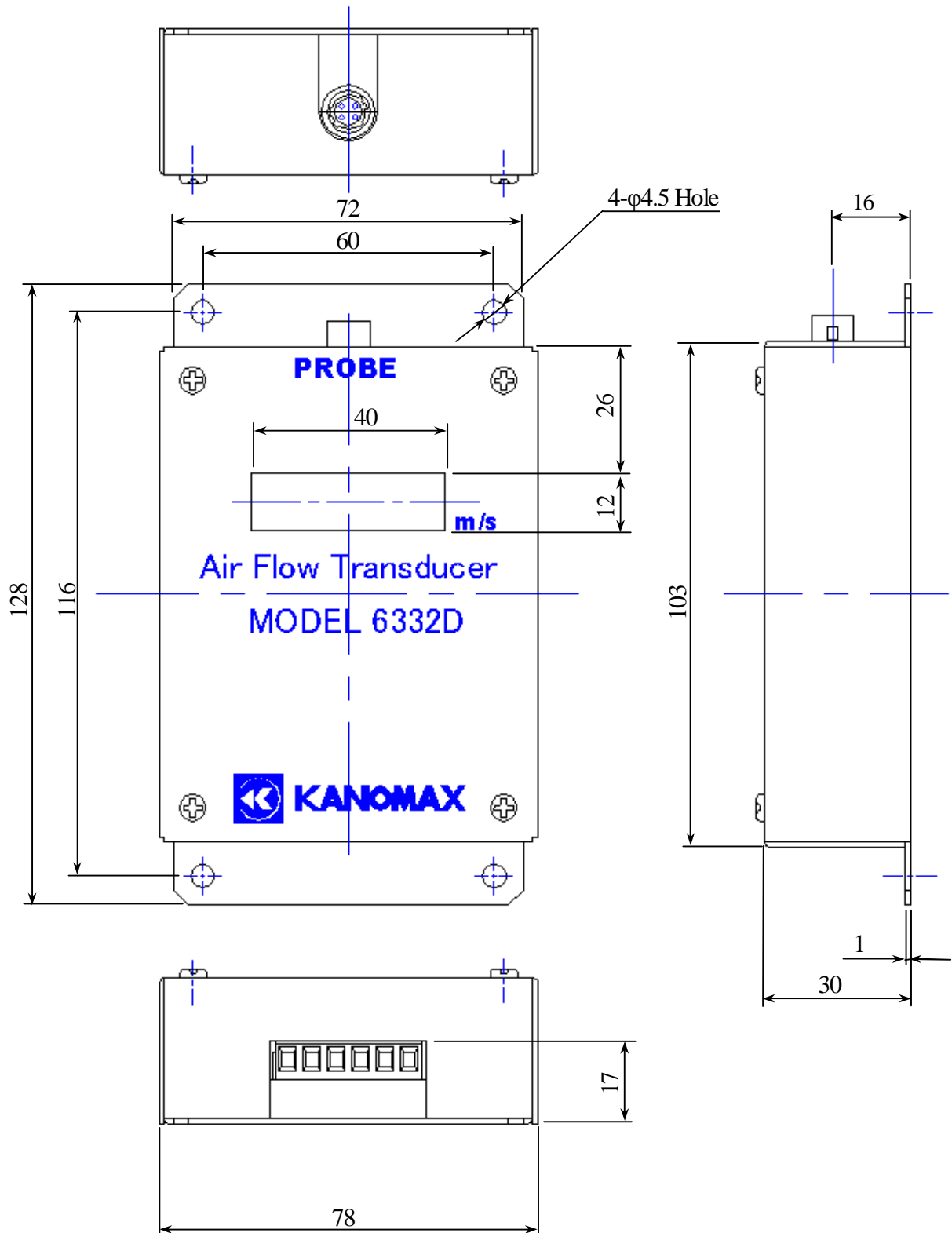

System Configuration Example

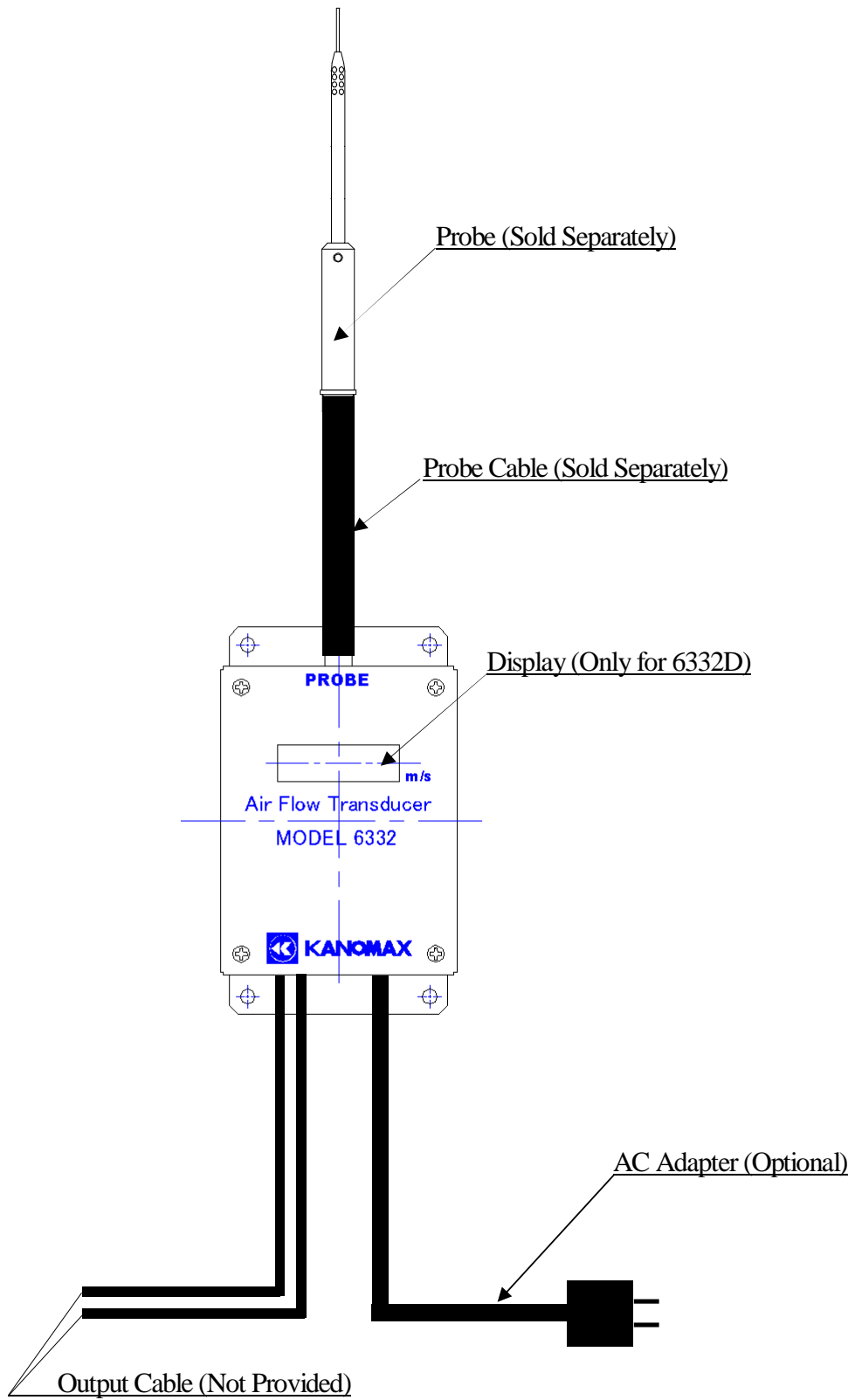

Connecting the Probe Cable to the Main Unit

<Caution>

- Make sure to cut the power supply to the main unit before connecting the probe cable (sold separately).
- The probe cable must be wired separately from the power line.

Match the concave part of the main unit connector with the convex part of the cable connector (4-pin), and click them in (not a screw type).

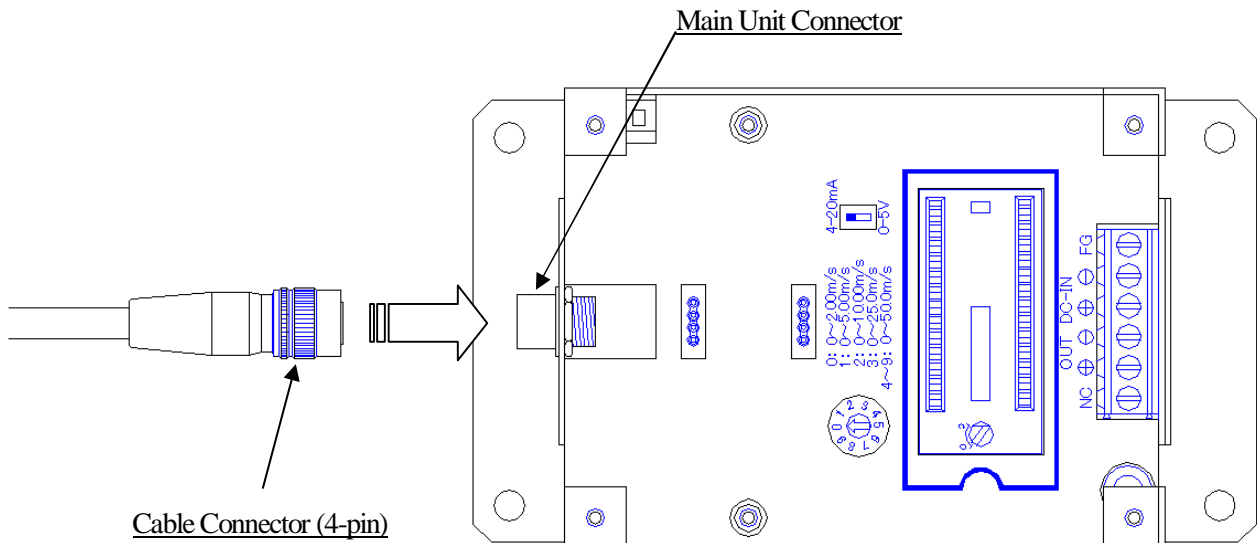

Connecting the Probe Cable to the Probe

<Caution>

- Make sure to cut the power supply to the main unit before connecting the probe and the probe cable (do not supply power until both are connected).
- Match the concave part of the cable connector (5-pin) with the convex part of the probe connector. Connect the probe and probe cable by rotating the screw portion **A** of the cable connector.

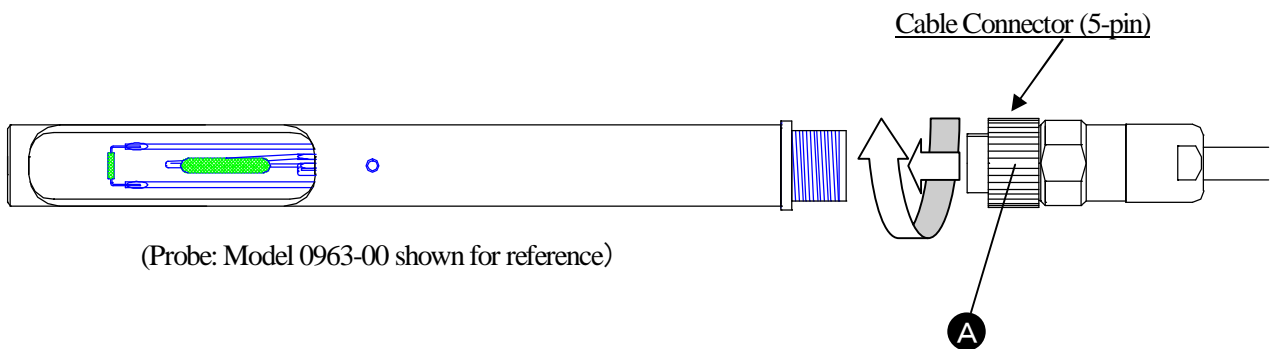

Installing the Data ROM

<Caution>

- Make sure to cut the power supply to the main unit before installing the Data ROM.
- Install the correct Data ROM that corresponds to the probe number.
- Position the Data ROM in the correct orientation.
- After confirming that the Data ROM is properly set, use the flat-blade screwdriver to rotate the cam 90 degrees clockwise to lock it in.

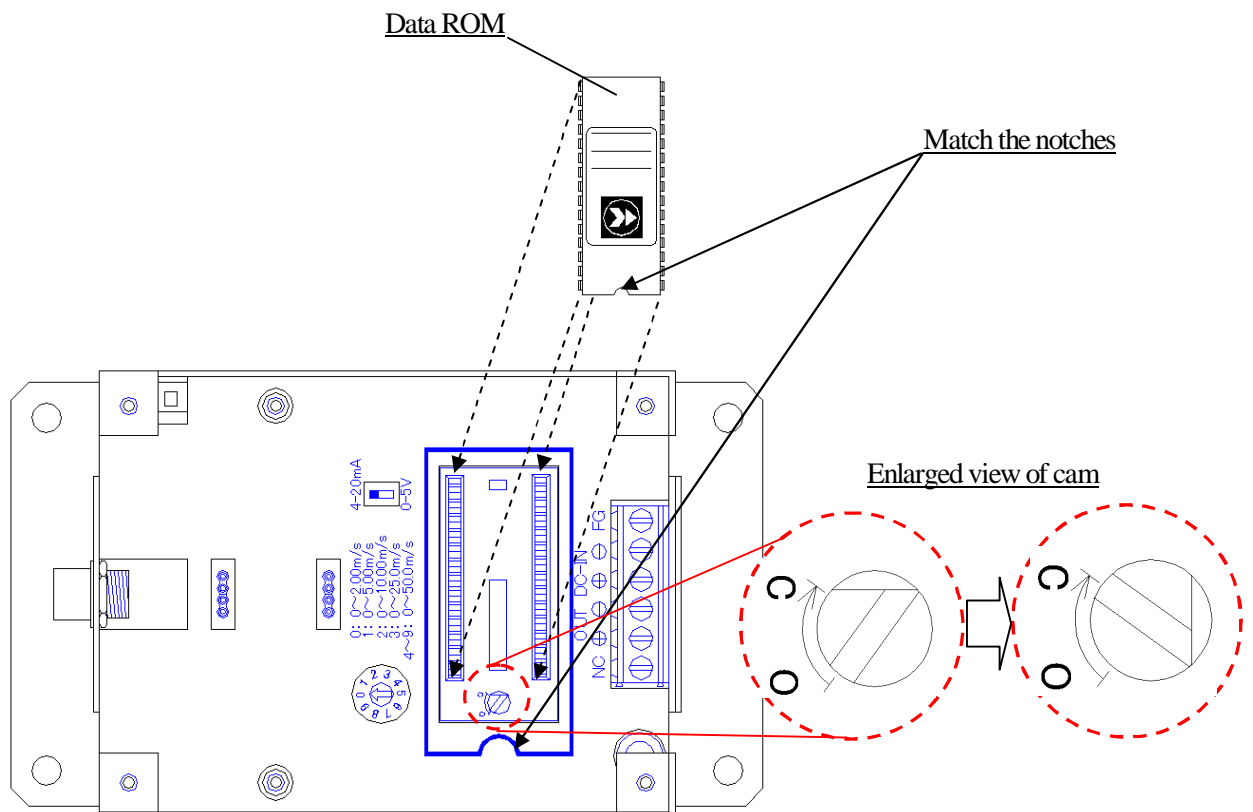

Switching Output (Setting Current/Voltage and Output Range)

<Caution>

- Make sure to cut the power supply to the main unit before switching the current/voltage output.
 - Output can be set by either voltage output (0 to 5V) or current output (4 to 20mA).
(The factory default setting is provided with current output.)
1. Current / Voltage output can be switched by the DIP switch.
 2. Setting of the output range can be made by the rotary switch (setting can be changed also while the power is supplied to the main unit).
 3. Output range can be selected from the following five (5) air velocity ranges. Select the optimum range according to the air velocity range to be measured.

No.	Output Range (m/s)	Example of Output when 2m/s	
		Current Output (mA)	Voltage Output (V)
0	0 ~ 2.00	20	5
1	0 ~ 5.00	10.4	2
2	0 ~ 10.00	7.2	1
3	0 ~ 25.0	5.28	0.4
4 ~ 9	0 ~ 50.0	4.64	0.2

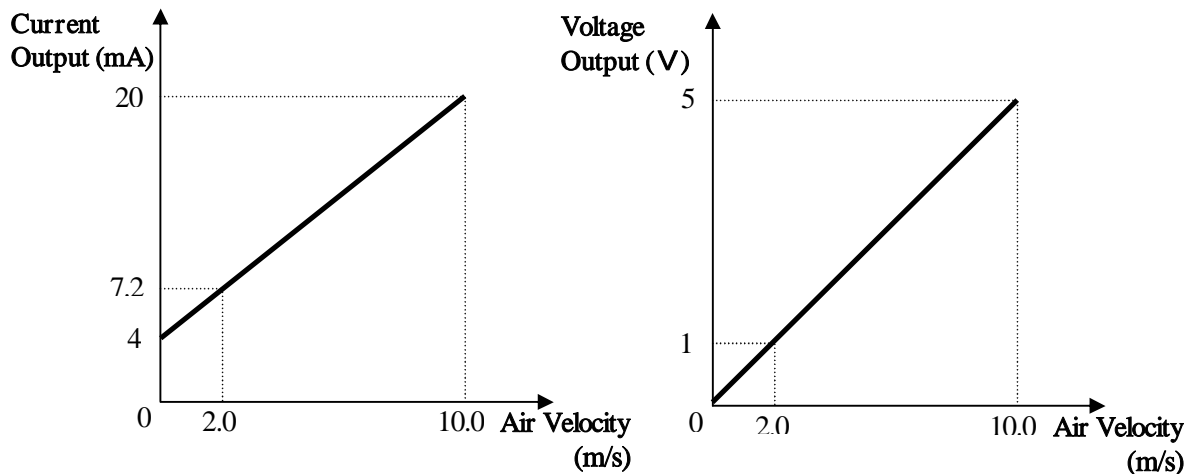

< Relation between Air Velocity and Current/Voltage Output (for Setting No.2) >

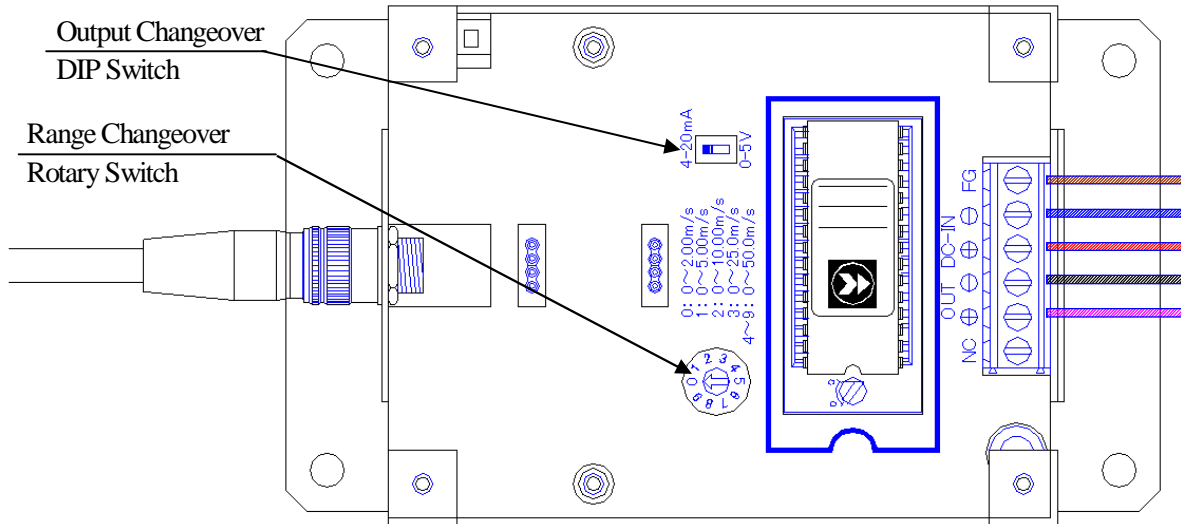

Connecting Output and Power Supply

<Caution>

- Pay attention to the polarity of power supply when connecting.
- Power supply voltage must be DC 12 to 24V.

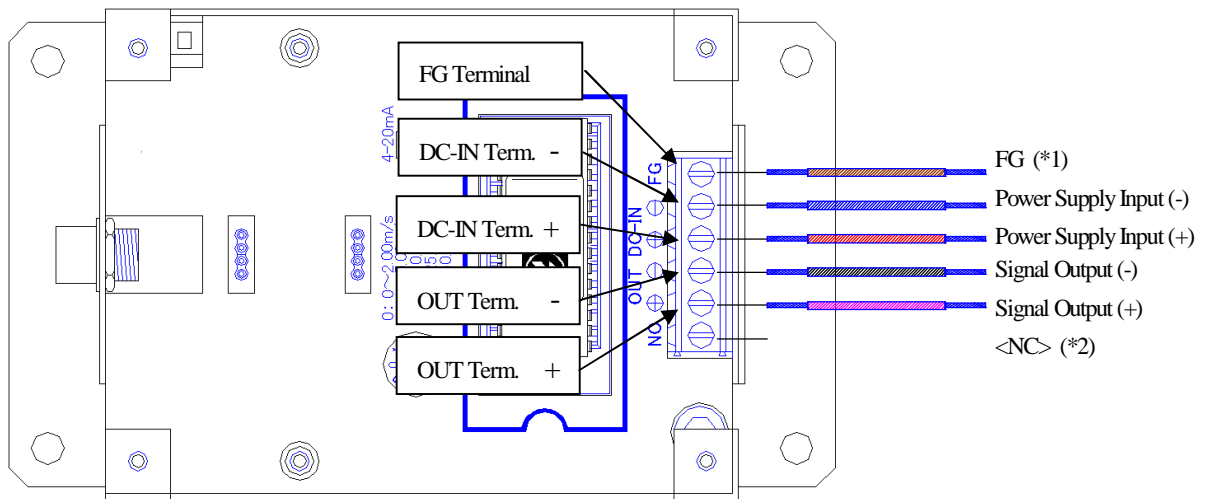

(*1) FG: Frame Ground ----- Connect to ground (earthing).

(*2) NC: No Connection ----- Connection is not required.

Measurement Method

1. Using the Uni-directional Probe (Model 0962-00, 0963-00)

These probes have directivity characteristics which require the direction mark to be faced against the airflow for measurement. When you are not sure of the airflow direction, slowly rotate the probe in the horizontal direction, and select the point where the air velocity reading is maximum.

2. Using the Omni-directional Probe (Model 0964-01/02, 0965-00, 0965-01/03/04/07/08)

These probes have uniform sensitivity 360 degrees horizontally. They only need to be set vertical to the airflow direction for measurement, regardless of the orientation in the horizontal direction.

<Caution>

The probe employs a set of air velocity sensor and temperature compensation sensor to compensate the air velocity change corresponding to the air temperature change.

In order to obtain this compensation effect, it is required that both the air velocity sensor and the temperature compensation sensor are exposed to the airflow to be measured under the same temperature condition. (Refer to the dimensional drawings of probes shown on page 16, 17 to locate the air velocity sensor and the temperature compensation sensor on each probe.)

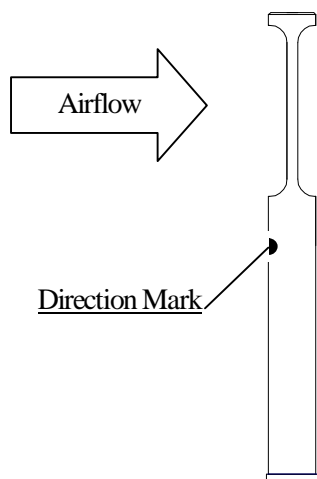

1. Uni-directional Probe



2. Omni-directional Probe

Probe Direction

Optional Accessory

1. Display Unit (Model 6332-01)

Number of digits and range of air velocity value to be shown on the display corresponds to the setting of the air velocity output range as shown below.

No.	Output Range [m/s]	Display Range [m/s]
0	0 ~ 2.00	0.00 ~ 2.00
1	0 ~ 5.00	0.00 ~ 5.00
2	0 ~ 10.00	0.00 ~ 10.00
3	0 ~ 25.0	0.0 ~ 25.0
4 ~ 9	0 ~ 50.0	0.0 ~ 50.0

To add the display substrate to a unit without a display (Model 6332):

- Position the substrate in the correct orientation, and fix the substrate with the supplied two screws carefully not to bend the connection pins.
- Replace the case without the display window with the case equipped with the display window (supplied with the display unit).

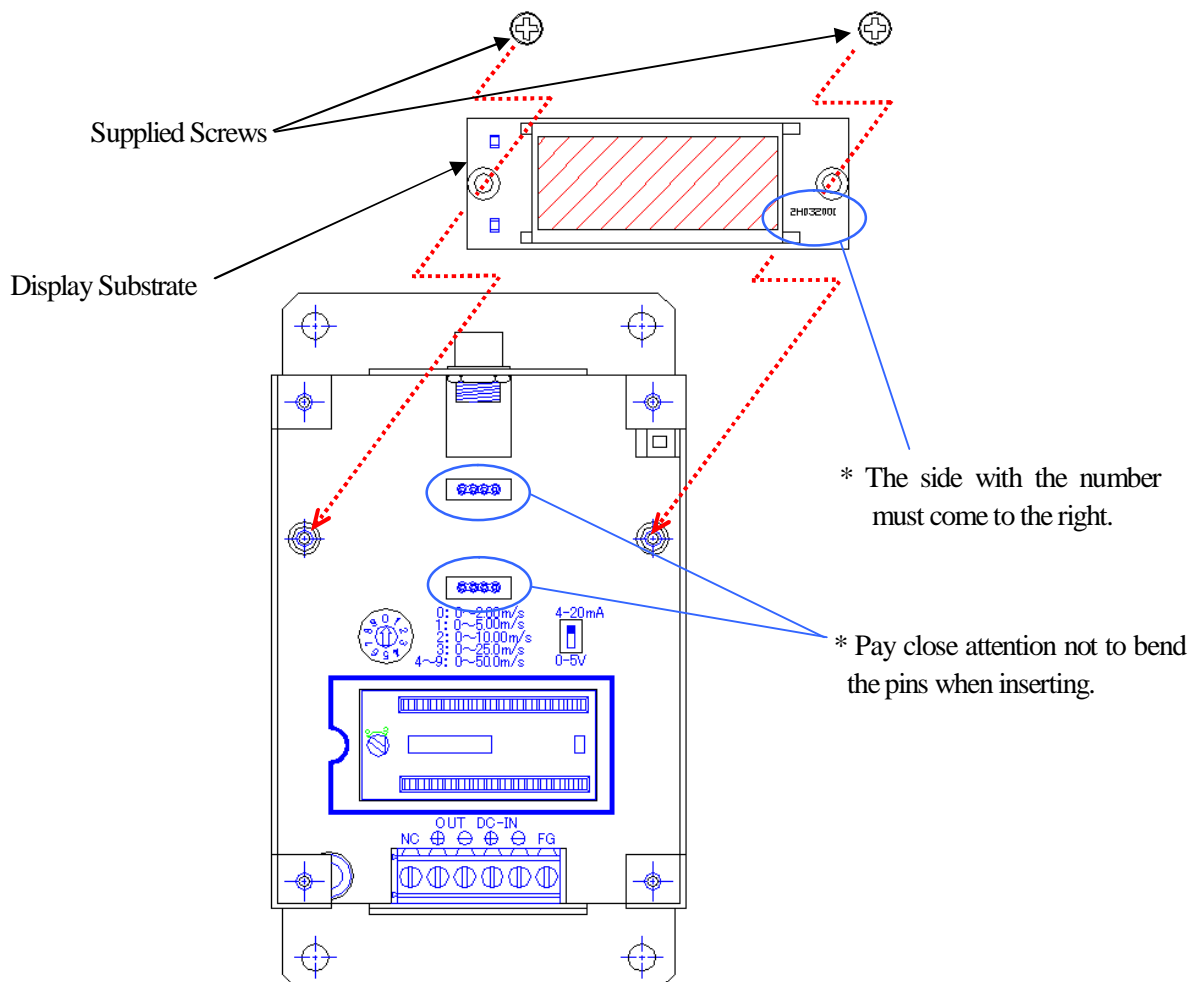

2. AC Adapter (Model 6332-02)

<Caution>

Do not connect the AC plug to the power receptacle before connecting the DC plug to the main unit. Failure to observe the above may cause short circuit and damage to the AC adapter.

Observe the polarity and firmly insert the DC plug into the main unit as shown below. Then connect the AC plug to the power receptacle.

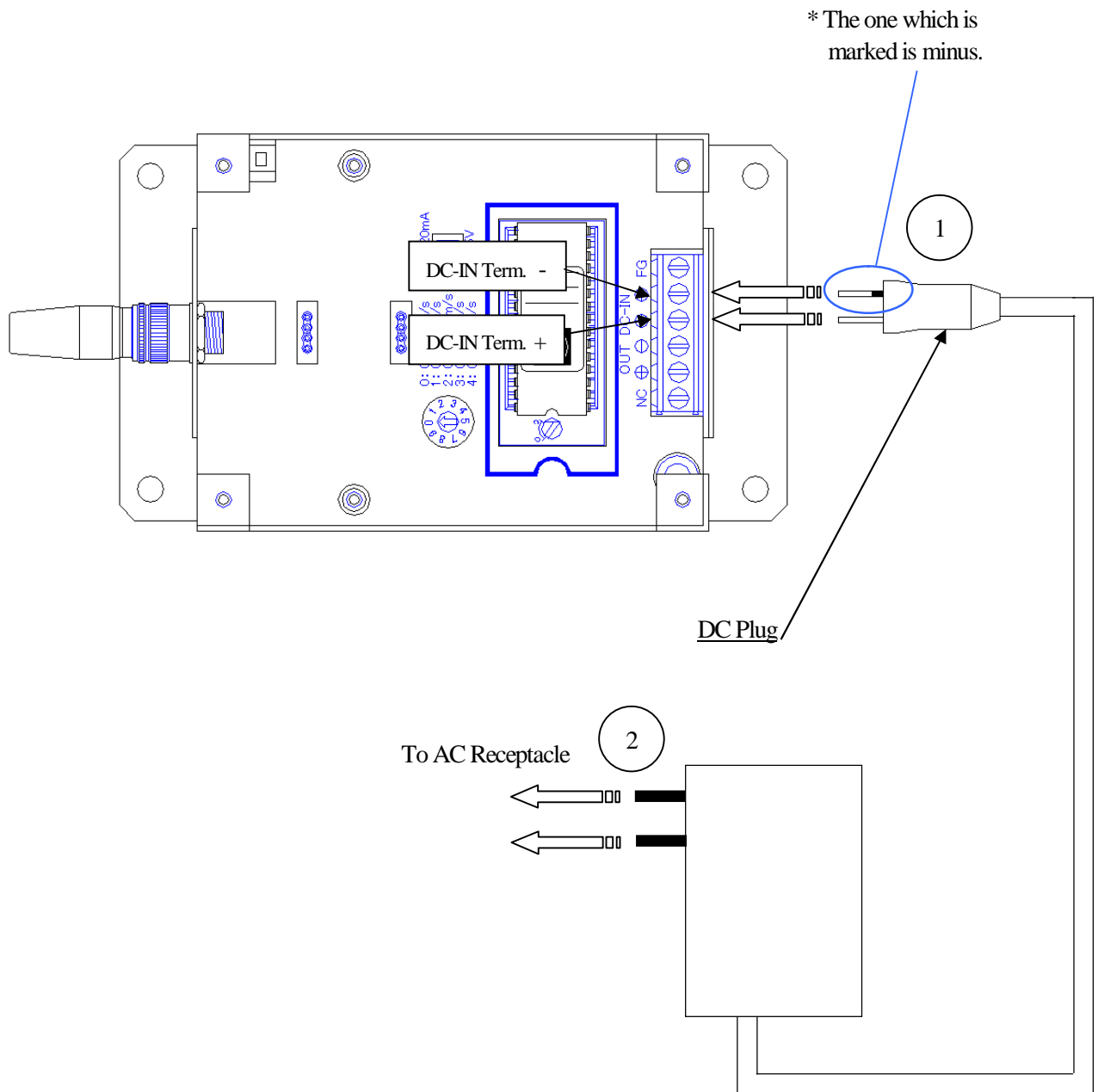

Cleaning the Probe

If any impurities such as dust, soot and oil are attached to the sensor, the amount of heat that the airflow draws from the sensor surface (heat dissipation rate) will change, thus the air velocity reading will be affected.

The probe must be cleaned when the sensor is contaminated from use in an unclean environment.

Cleaning Method

Clean the sensor portion of the probe in an ultrasonic cleaner for approx. 10-20 sec. Do not clean the sensor longer than required as excess cleaning will lead to sensor damage.

Use tap water (or purified water) for cleaning. The sensor portion can also be cleaned in a vessel filled with neutral detergent diluted with water, and by stirring it in the vessel.

! Caution !

- !) Make sure to TURN OFF the power before cleaning.
- !) Dry the probe completely after cleaning. Do not use the probe before it is completely dried.

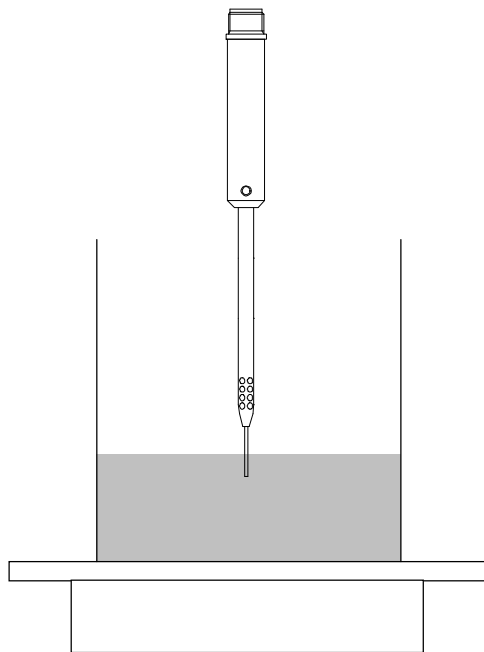

Clean in an ultrasonic cleaner for approx. 10-20 sec.

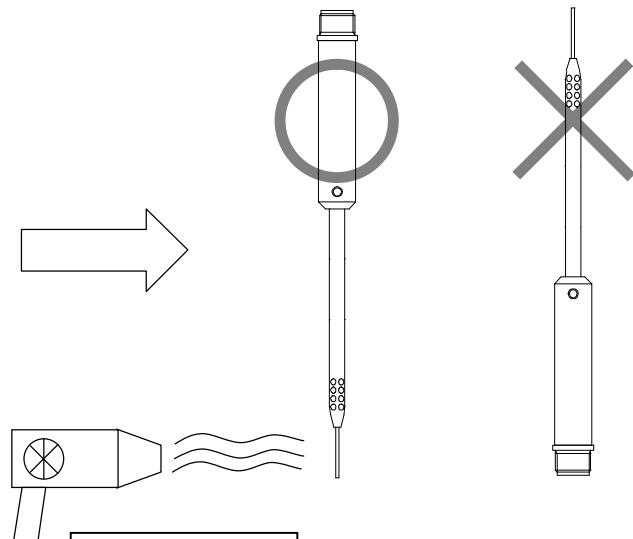

Do not point the sensor upwards until it is completely dried. The water drops may get inside the probe and cause malfunction.

Dry with cold air.

Specification of Main Unit

Product Name	Airflow Transducer (with / without Display)				
Model	6332 / 6332D				
Measuring Object	Clean Airflow				
Measuring Range	Maximum range 0.1 ~ 50 m/s (Depending on the measurement range of the probe*)				
Measuring Accuracy	± (3% of reading + 0.1) m/s				
Temperature Compensation Range		0.1-4.99m/s	5.00-9.99m/s	10.0-24.9m/s	25.0-50.0m/s
	5~40°C	±0.25m/s	±0.50m/s	±1.25m/s	±2.50m/s
	40~80°C	±0.35m/s	±0.70m/s	±1.75m/s	±3.50m/s
Output	To select either current or voltage output (setting made with the DIP switch). Current output: DC 4~20mA (Max. load resistance: 250Ω) Voltage output: DC 0~5V				
Setting of Output Range	To be selected from the followings (setting made with the rotary switch). 0~2, 0~5, 0~10, 0~25, or 0~50 m/s				
Display (Optional)	Number of digits and range of value to be displayed change in accordance with the setting of the output range. When setting of output range: 0~2, 0~5, 0~10 m/s → Display Resolution: 0.01m/s When setting of output range: 0~25, 0~50 m/s → Display Resolution: 0.1m/s				
Power Supply	DC 12~24V				
Power Consumption (Reference Value)	Approx. 2.0W (Under the following conditions - power supply: 12V, air velocity: approx. 10m/s, using a unit with a display with probe model 0965-03.) Power consumption rate is subject to change according to conditions such as air velocity, probe type and use of display.				
Connection Wire Size	0.5 ~ 1.5 mm ²				
Operating Temperature Range	5 ~ 40 degrees C				
Storage Temperature Range	-10 ~ 50 degrees C				
Dimensions	Approx. 128(W)×78(D)×30(H)				
Weight	Approx. 320g				
Standard Accessory	Operation Manual : 1 Main Unit Case: 1				
Optional Accessory	Probe Cable (10m, 20m, 30m) Display Unit (Supplied with a case with a display window and 2 installation screws.) Dedicated AC Adapter (DC12V)				

* Refer to "Specification of Probes" on page 16.

Specification of Probes (Sold Separately)

MODEL	Measuring Range	Sensor Type
0962-00	0.1~50.0m/s	Uni-directional
0963-00		
0964-01		Omni-directional (Needle)
0964-02		
0965-00	0.1~25.0m/s	Omni-directional (Spherical)
0965-01		
0965-03	0.1~25.0m/s	Mini-temperature-compensation-sensor integrated type
0965-04		Omni-directional (Spherical)
0965-07		Mini-temperature-compensation-sensor independent type
0965-08		Omni-directional (Spherical)

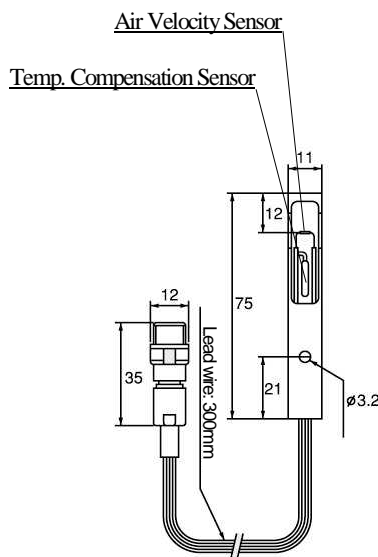

0962-00

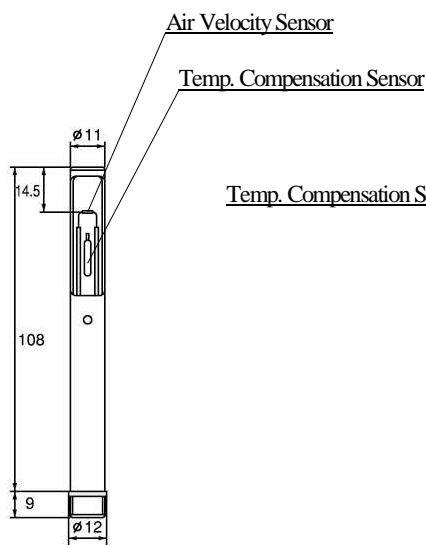

0963-00

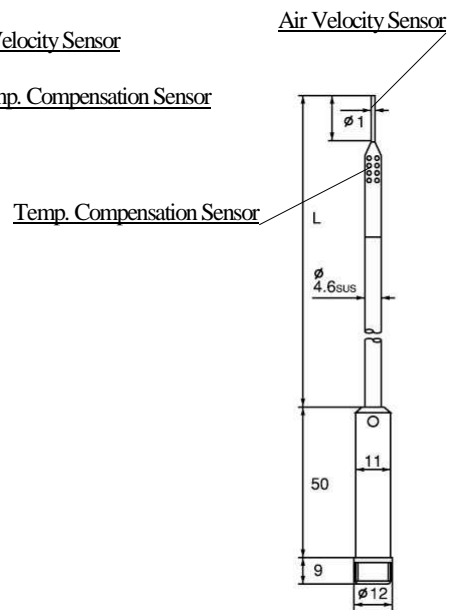

0964-01 (L=80mm)
0964-02 (L=400mm)

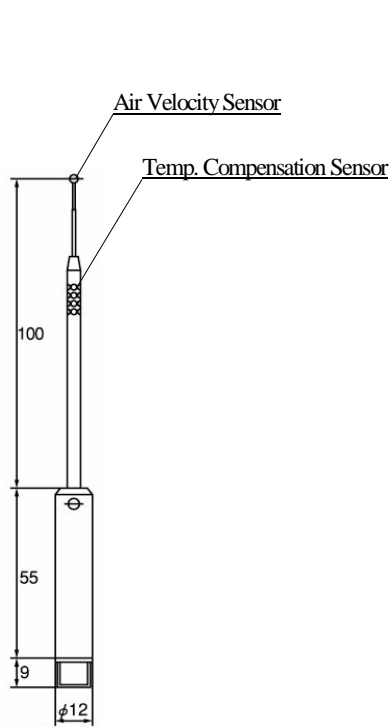

0965-00/01

00: protruding tip

01: no protrusion

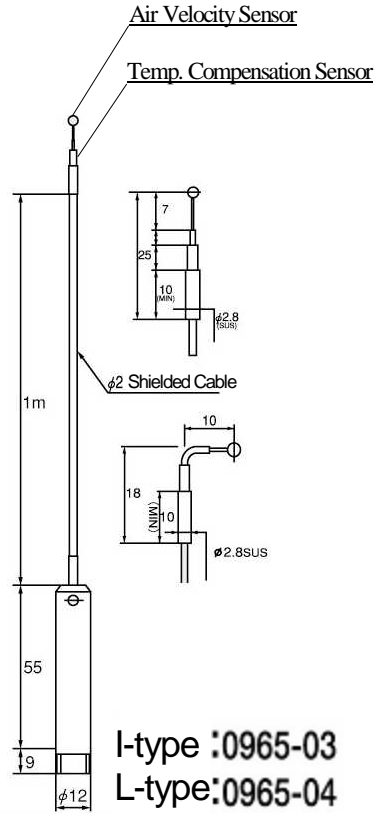

I-type :0965-03

L-type:0965-04

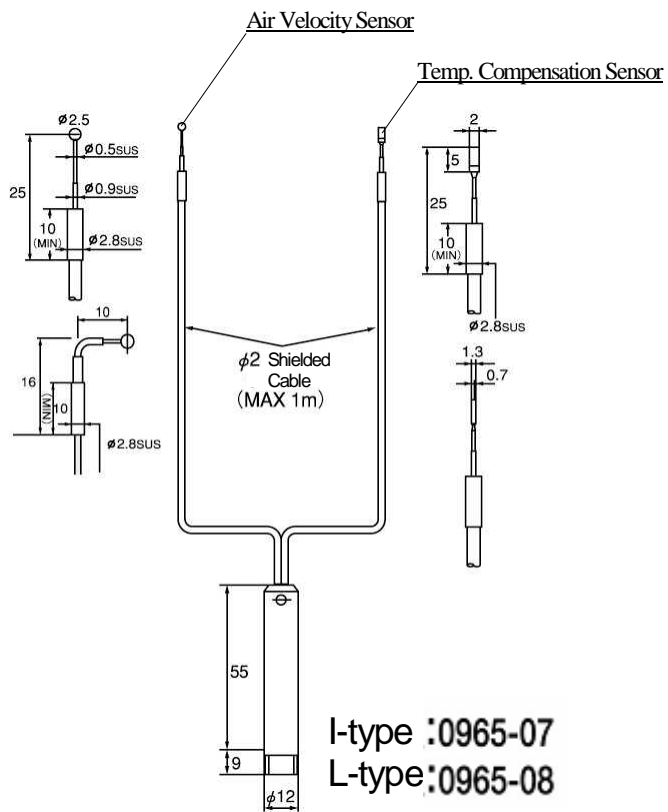

I-type :0965-07

L-type:0965-08

Troubleshooting

Please check the following list before requesting a repair:

Symptom	Possible Cause	Solution (& Reference Page)
No Output	The main unit is not turned on.	Supply power to the main unit. (Page 10)
	Wrong wiring of the output terminal.	Provide proper wiring. (Page 10)
	Probe is not connected properly.	Turn off the power. Reconnect the probe to the main unit and turn the power back on. (Page 6)
	Contact of the terminal block is dirty.	Clean the contact of the terminal block.
Abnormal Output	Probe is not connected properly.	Turn off the power. Reconnect the probe to the main unit and turn the power back on. (Page 6)
	The ROM number is not consistent with the probe number.	Insert the correct ROM that corresponds to the probe number. (Page 7)
	Probe is dirty.	Clean the probe. (Page 14)
	Measured velocity is out of the specified range.	Confirm the probe specifications. (Page 16)
	FG terminal is not connected to ground.	Confirm that FG terminal is properly connected to ground (earthed). (Page 10)
	Influence of noise.	Confirm the output in an environment with less noise (e.g. outside the office or plant). If the output there is found to be normal, noise prevention measures need to be taken at the measurement location. For details, please contact our service center.

Product Warranty and After Service

Product Warranty

- A warranty card is not included in this product.
- This product is warranted against defects in materials and workmanship for a period of one year from the date of original purchase.

After Service

- When you have a problem with your unit, please check out the “Troubleshooting” section (page 18) first.
- If that does not help, please contact your local distributor, or call our service center (See last page for contact information).
- During the warranty period, we will repair at no charge a product that proves to be defective due to material or workmanship under normal use. The limited warranty covers all defects encountered in normal use of the product, and does not apply in cases such as; loss or damage to the product due to abuse, mishandling, alternation, or natural disaster. All return shipping charges are the responsibility of the customer.
- Repair after warranty expiration:
Upon request, we will repair the instrument at the customer’s expense, if the instrument’s performance is found to be recoverable by providing the repair.
- Replacement parts are available for a minimum period of five (5) years after termination of production. This storage period of replacement parts is considered as the period during which we can provide repair service. For further information, please contact our service center.
- When making an inquiry, please provide the following information.

Please inform us:

- Product Name: Air Transducer
- Model Number: 6332 or 6332D
- Serial Number: xxxxxx
- Probe Model: Your Probe Model
- Description of Symptom in detail.
- Date of Purchase: Month / Year

Contact Information



JAPAN

KANOMAX JAPAN, INC.

2-1 Shimizu Suita City, Osaka 565-0805, Japan

TEL: 81-6-6877-0183 **FAX:** 81-6-6879-5570

URL: <http://www.kanomax.co.jp/>

E-Mail: sales@kanomax.co.jp

USA & EUROPE

KANOMAX USA, INC.

PO Box 372, 219 Route 206, Andover, NJ 07821 U.S.A.

TEL: (800)-247-8887 / (973)-786-6386 **FAX:** (973)-786-7586

URL: <http://www.kanomax-usa.com/>

E-Mail: info@kanomax-usa.com

CHINA

Shenyang Kano Scientific Instrument Co., Ltd

No. 12, 4 Jia Wencui Road Heping District

Shenyang City PRC

TEL: 86-24-23845309 **FAX:** 86-24-23898417

URL: <http://www.kanomax.com.cn/>

E-mail: sales@kanomax.com.cn