

Light Scattering Digital Dust Monitor

MODEL 3443

Operation Manual

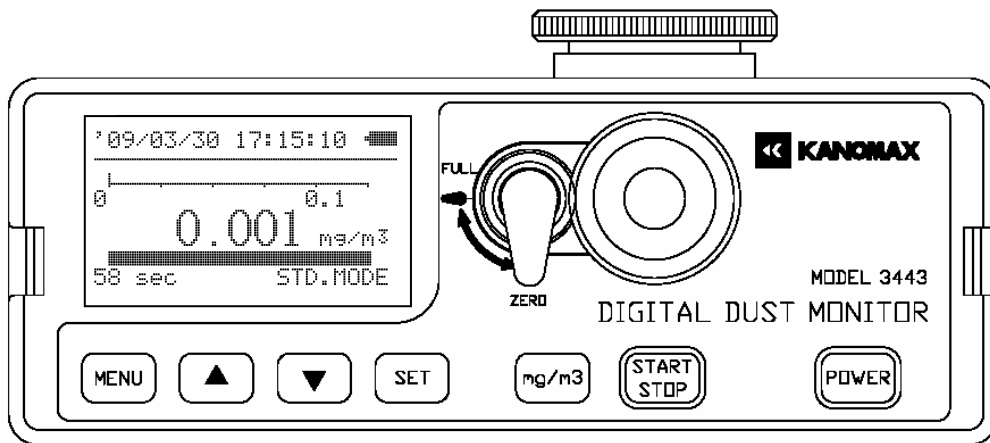

Please read this operation manual carefully and understand the warnings described within before operating this instrument.

Keep this manual handy for future reference.



01001

10.06

Component List

■ Standard

Item	Model	Qty	Function
Main Unit	3443	1	-
AC Adapter	6113-02	1	-
Filter	-	2	Spare Filter (For cleaning)
Shoulder Strap	-	1	-
Operation Manual	-	1	-
Manganese Batteries	-	6	Size AA batteries (for testing)
Measurement Software	S344-30	1	CD-R
Communication Cable	-	1	USB Communication Cable
LCD Protective Sheet	-	1	Spare Sheet
Rubber Cap	-	1	-
Rubber Cap String	-	1	-
Rubber Protector	3443-02	1	-

■ Optional Extras

Item	Model	Function
Output Cable	3442-01	For Analog, Pulse and Alarm Output
Carrying Case	3442-05	-

■ Consumables (sold separately)

Item	Model	Unit (Qty)
Rubber Cap	3431-02	1 pc
Filter	3431-03	1 Set (10 pc)
LCD Protective Sheet	3442-04	1 Set (2 pc)
AC adapter	6113-02	1 pc
Rubber Protector	3443-02	1 set

Important Safety Information

Warning types and classifications are defined as follows in this manual.

[Classification]



WARNING: To Prevent Serious Injury or Death

It indicates a potentially hazardous situation which, if not avoided, may result in serious injury or death.



CAUTION: To Prevent Damage to the Product

It indicates a potentially hazardous situation which, if not avoided, may result in damage to the product that may void the product warranty.

[Description of Symbols]







indicates the condition (including danger) that requires caution. The subject of each caution is illustrated inside the triangle (e.g., the symbol shown on the left is high temperature caution).



⊘ indicates prohibition. Do not take the prohibited action shown inside or near this symbol (e.g., the symbol shown on the left prohibits disassembly.)

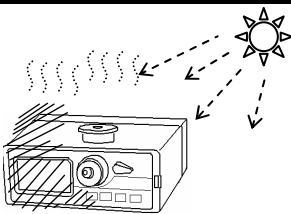

● indicates a mandatory action. A specific action is given near the symbol.

 WARNING	
 Do not modify/disassemble	<p>⊘ Do not disassemble, modify or repair the instrument.</p> <p>..... Failure to observe the above may result in short circuit and malfunction.</p>
 Handle Properly	<p>● Use the instrument properly by carefully following this operation manual.</p> <p>..... Misuse of the instrument may result in electric shock, fire, damage to the instrument.</p>
	<p>● If any abnormal noise, unusual odor or smoke is emitted, or any liquid enters into the instrument, turn the power off immediately, remove the battery and disconnect the power cable.</p> <p>..... It may result in electric shock, fire or damage to the instrument. Contact your distributor or your KANOMAX service center for repair.</p>
 Prohibited Installation	<p>⊘ Do not use this instrument in an ambient temperature above 40 °C.</p> <p>..... Dielectric degradation may occur, which may result in short circuit of fire.</p> <div style="text-align: right;">  </div>

 **WARNING**



- ⊠ Unplug the power cable when the instrument is not in use.
..... Failure to observe the above may result in electric shock, fire or damage to the internal circuitry.
- ⊠ When using the AC adapter, ensure there is no dust on the power plug. The AC outlet used must be within the specified power requirement of 100 ~ 240 V.
..... Failure to observe the above may result in fire.
- ⊠ When using the AC adapter, make sure to use the one provided with this instrument.
..... Other commercially available adapters may have different polarity and specifications, which could result in short circuit, fire or damage to the instrument.

 **CAUTION**



Prohibited Installation

- ⊠ Do not perform measurements in an environment exceeding the specified temperature and RH level of the instrument. Also the instrument should not be exposed to direct sunlight for prolonged periods.
..... The instrument may not function properly outside the specified environment. (5 ~ 40 °C, 95 %RH or lower, non condensing)

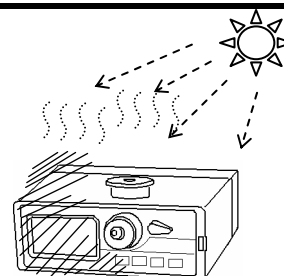

Prohibition

- ⊠ Do not wipe the instrument with volatile solvents.
..... The body may be deformed or deteriorated. Use soft dry cloth to remove stains. If stains persist, soak the cloth in a neutral detergent or water and wipe the instrument with the cloth. Never use volatile solvents such as thinner or benzene.



Prohibition

- ⊠ Do not subject the instrument to strong shock. Do not place heavy objects on the instrument.
..... Failure to observe the above may cause damage to the instrument.



- ⊠ Do not touch the instrument when it is or you are electrically charged.
..... Failure to observe the above may affect measurement value and cause damage to the instrument circuitry.

- ⊠ After using the instrument in the highly concentrated environment (100 CPM), make sure to perform a cleaning every time.
..... Leaving the instrument without cleaning after a measurement, inside the optical system gets dirty and ZERO point may not be able to be adjusted.

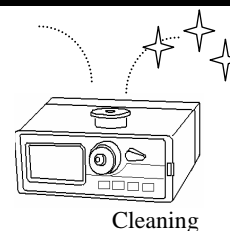

Table of Contents

1. Part Names and Functions	1
1.1 General Outline	1
1.2 Measurement Principle.....	1
1.3 Laser Handling	1
1.4 Part Names	2
2. Getting Started	4
2.1 Setting batteries or AC adapter	4
2.1.1 Setting batteries	4
2.1.2 Setting AC Adapter.....	5
2.2 Precautions for Storing and Transporting the Instrument	6
2.3 Cleaning.....	7
2.4 Calibration	8
3. Display Description and Operation Procedure	9
3.1 Boot Screen	9
3.2 Initial Screen.....	9
3.3 Screen While Measuring	10
3.4 MENU	12
3.4.1 Measurement Mode	12
A) Standard Mode (STD. MODE)	13
B) Free Setting Mode	15
C) Manual Mode	15
3.4.2 Calculation Mode.....	16
A) Measurement Start Date & Time.....	16
B) Sampling Time	16
C) The Number of Sampling Trials.....	16
D) To Start a Measurement	16
3.4.3 Data Display	18
3.4.4 Deleting Data	20
A) To Delete Only the Selected Measurement Data.....	20
B) To Delete All Measurement Data.....	20
3.4.5 Calibration	21
3.4.6 Utility	23
A) Cleaning	23
B) Time Adjustment.....	24
C) K Factor.....	25
D) LCD / Beep Sound Setting	26
E) Analog Output & Alarm Setting	28
F) Pulse Output	31
G) Output Cable (3442-01) -external appearance-	31
H) TWA MODE	32
3.4.7 USB Communication Connector	33
3.5 Measurement Procedure	34

4. Consumables Replacement	35
4.1 Filter Replacement	35
4.2 Protective LCD Sheet Replacement	36
5. Main Specification	37
6. Troubleshooting	39
6.1 Check Power.....	39
6.2 Check while Measuring.....	39
6.3 Zero Check	40
6.4 Sensitivity Check.....	40
6.5 Calibration Check.....	41
6.6 Analog Output	41
6.7 Pulse Output	42
6.8 Alarm Output.....	42
6.9 Calendar Setting	42
7. Warranty and After-sales Service	43
8. Contact Information	45

1. Part Names and Functions

1.1 General Outline

This instrument (Model 3443) is a light scattering portable dust monitor using a semiconductor laser radiation light source.

The measurement data is displayed on the LCD and can be saved to internal memory.

The measurement data can be retrieved using the provided software.

<Features>

- Dimensions are reduced significantly compared to previous models
- User-friendly menu.
- Calibration operation can be handled from the display screen.
- Data logging function allows users to redisplay saved data.
- Using nonvolatile memory secures a worry-free measurement and saves measurement data and correction memory such as calibration parameters indefinitely.
- USB is standard for communications.
- The instrument can interface with an external device via analog output, pulse output and alarm output which are equipped standard. (The output cables are sold separately.)

1.2 Measurement Principle

When dust is irradiated, the scattered light intensity from the dust is proportional to the mass concentration. Using this mechanism, this dust monitor measures the mass concentration of airborne dust.

1.3 Laser Handling

Laser Classification

This instrument is classified as a Class 1 Laser Product.

* Class 1 Laser:

Laser that is considered to be safe under reasonably foreseeable conditions of operation, including the use of optical instruments for intrabeam viewing.

Laser Safety Instruction

This instrument employs a laser inside the unit as the light source of the sensor. Never open/remove the case of the unit or disassemble the optical sensor inside the unit.



Caution: The laser diode used inside this instrument is classified as class 3B by laser safety standard.

Directly viewing or touching the laser beam is hazardous. Therefore never disassemble or modify the instrument.

1.4 Part Names

Unit: mm

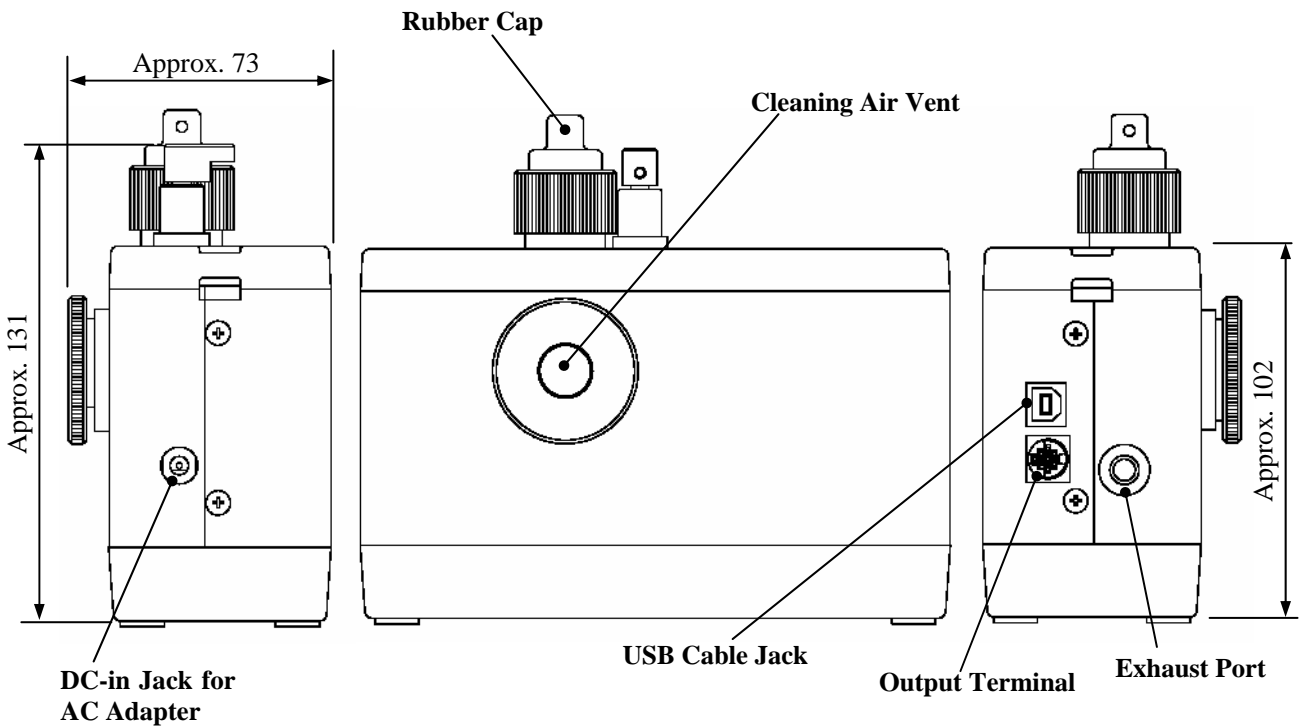
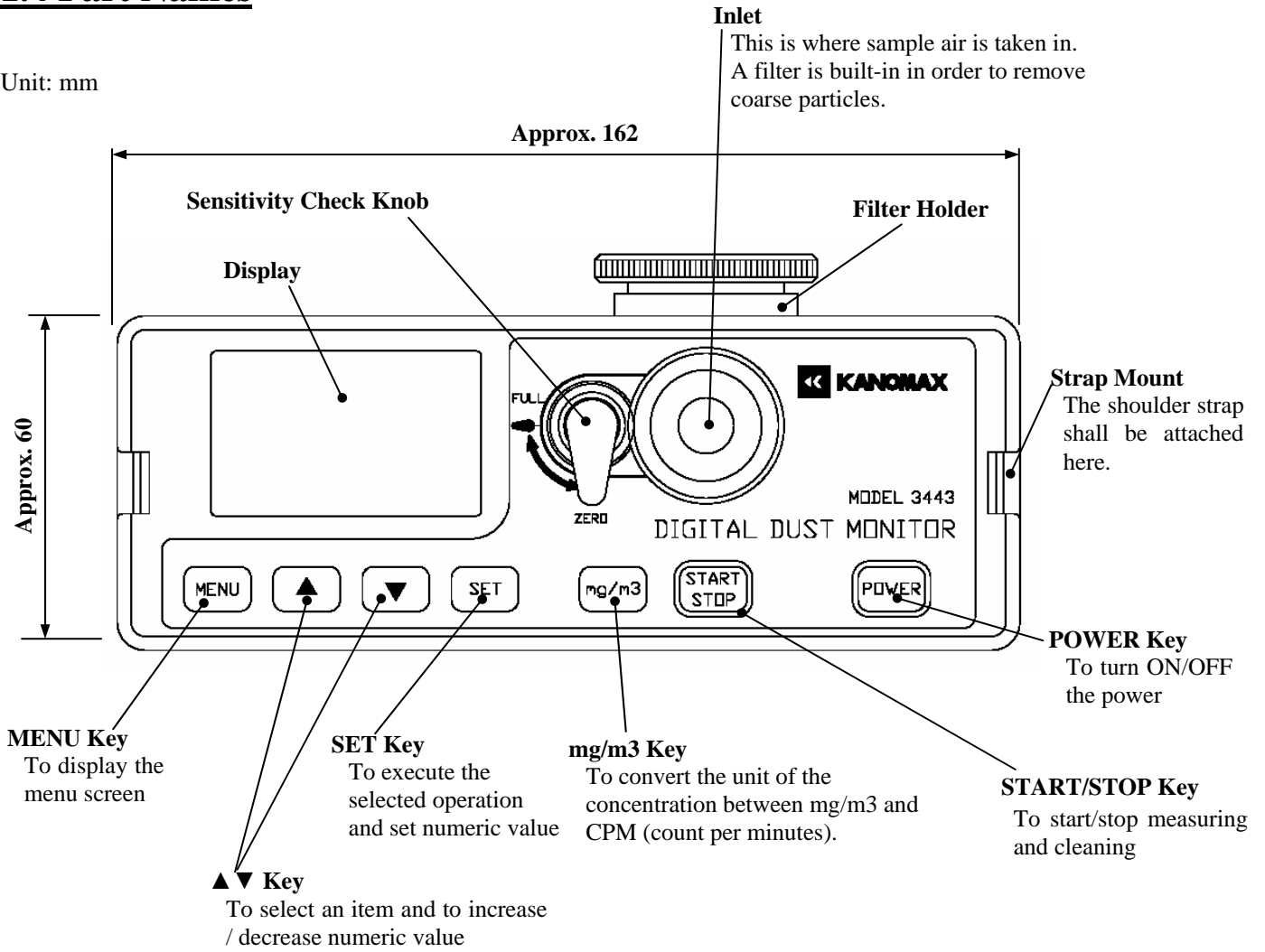

<Part Description>

Name	Function
Sensitivity Check Knob	This is a changeover switch to check sensitivity. When checking sensitivity, turn the knob to the “FULL” side and check if there is any significant change in the standard count value. (Refer to 2.4 Calibration) At times other than the sensitivity check, turn the knob to the “ZERO” side. To turn the knob to the “ZERO” side, press the knob and turn it to the “ZERO” side.
Inlet	This is where sample air is taken in. A filter is built-in to remove coarse particles.
Filter Holder	A filter to be used during ZERO point check and cleaning is built-in. See page 35 for the replacement procedure.
Rubber Cap	When measuring, remove it from the inlet and put it on the filter holder. When performing ZERO check, sensitivity check and cleaning, leave the rubber cap on the inlet.
Strap Mount	The shoulder strap shall be attached here.
Exhaust Port	This is where the air is exhausted from the internal pump. When the instrument is in use, never block the exhaust port.
Cleaning Air Vent	This is where air is taken in upon cleaning. When the filter is significantly dirty, replace the filter by the provided spare filter or purchase a new filter (3431-03). See page 35 for more details.
Output Terminal	Connect the output cable (3442-01) sold separately. - Analog Output: The voltage equivalent to 0 ~1 V is output for 0 ~ 1,000 CPM or 0 ~ 10,000 CPM. Set the load impedance to 1 kΩ or higher. The output is linear in the output range. Instantaneous value is output. - Pulse Output: The pulse equivalent to 0.0166Hz ~ 166.6 Hz is output for 1 ~ 10,000 CPM. This is photocoupler output. (no-voltage contact output) - Alarm Output: Output will be on when the value exceeds the alarm setting value. Photocoupler output is applied (no-voltage contact output). When the alarm is detected, the phototransistor will be ON.
DC-in Jack for AC Adapter	Make sure to use the provided AC adapter (MODEL 6113-02).
USB Cable Jack	Connect the provided communication cable to a PC for data download and to perform a measurement.
Rubber Protector	This is a protective cover for the instrument in case the instrument falls over or is hit by something. This rubber protector is also required to fix the instrument on a tripod. AC adapter, output connector and communication connector can be used even when the rubber protector is on.
Tripod Screw 1/4 – 20UNC	Use this screw to fix the instrument on a tripod.

2. Getting Started

2.1 Setting batteries or AC adaptor

This instrument can use batteries or AC adaptor for its power. Set batteries in the instrument or connect the AC adaptor.

2.1.1 Setting batteries

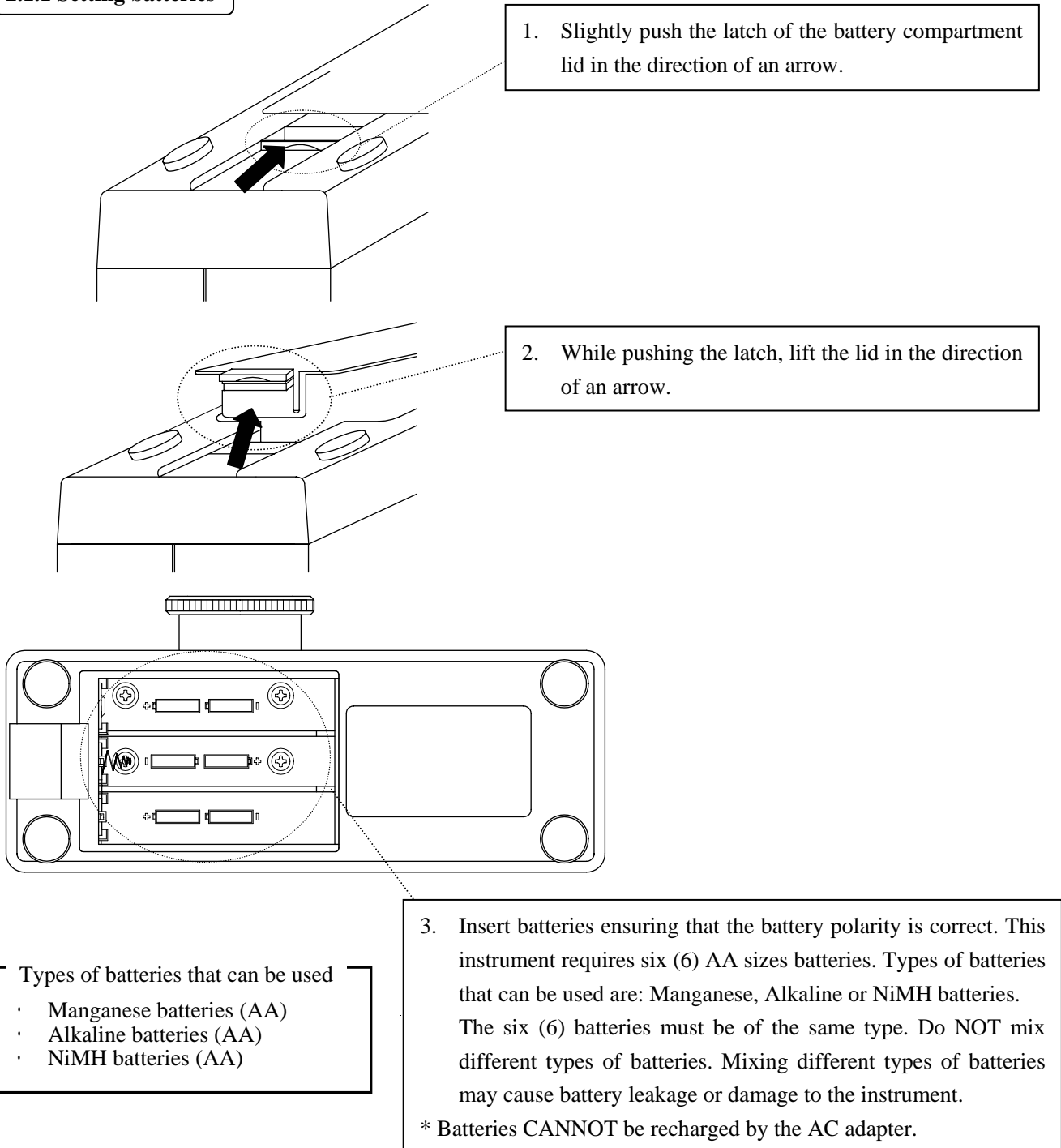

2.1.2 Setting AC Adapter

Connect the supplied AC adapter into the DC-in Jack on the side of the main unit. When the AC adapter is connected, the power is supplied by the AC adapter. It is OK to leave batteries in the battery compartment. However, if the instrument is not used for a prolonged time, please remove the batteries to prevent the contact failure caused by corrosion of the battery.

<AC Adapter>
 MODEL 6113-02
 INPUT: 100 ~ 240 V
 OUTPUT: 9V/2A
 Polarity

DC-in Jack for AC Adapter

CAUTION: Make sure to use the provided AC adapter (MODEL 6113-02). Other commercially available adapters may have different polarity and specifications, which could result in short circuit, fire or damage to the instrument.

◆ Battery Level Indicator

Battery level indicator is displayed on the upper right corner of the display.

The below shows how the indicator changes as the battery runs low.



<<Caution>>

- The remaining capacity of the battery is indicated in 10 levels. When “×” is displayed on the indicator, the remaining capacity of the battery is very low. Connect the provided AC adapter immediately or finish a measurement once and replace the batteries with new ones.
- When the batteries die, the display will be turned off and the power will also be off.

2.2 Precautions for Storing and Transporting the Instrument

◆ Precautions for Storing the Instrument



Caution: If the unit is not used for a prolonged time, do not leave the batteries in the battery compartment. Otherwise, the batteries may corrode, causing contact failure.

◆ Precautions for Transporting the Instrument



Caution: For long periods of transporting the instrument, as mentioned above, do not leave the batteries in the battery compartment.

2.3 Cleaning

To maintain the accuracy, make sure to perform cleaning before using the instrument.
(When measuring for all day, please perform cleaning before and after measuring.)

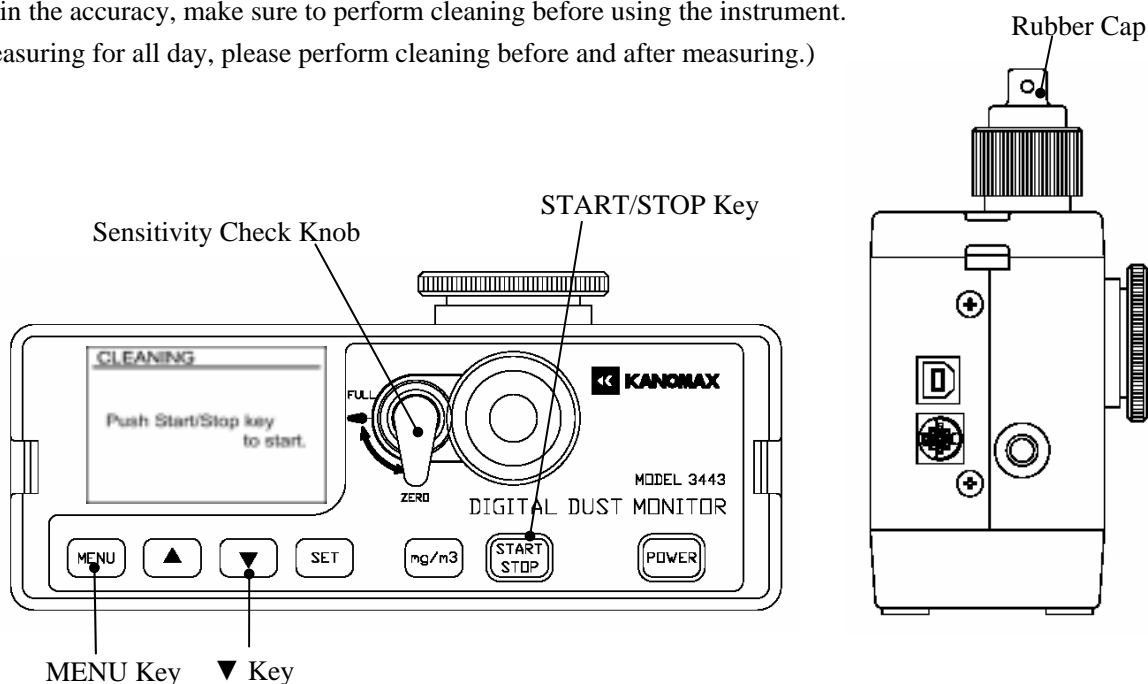

- (1) Confirm that the surrounding atmosphere is clean. Put the rubber cap on the inlet as shown in the above picture and press [POWER] key to turn the power ON.
- (2) Confirm that the sensitivity check knob is at the “ZERO” side.
- (3) Press [MENU] key to display the menu.
- (4) Press [▼] key (or [▲] key) to move the cursor to “UTILITY” and press [SET] key to display the UTILITY screen.
- (5) Confirm that the cursor is on “CLEANING”, and then press [SET] key to display the CLEANING screen.
(Refer to **A)Cleaning** in **3.4.6 Utility**.)
- (6) Press [START/STOP] key to start cleaning.
- (7) Perform cleaning for about 5 minutes.
* The required time for cleaning varies depending on the usage environment.
- (8) Press [START/STOP] key to finish cleaning.

* To shorten the cleaning time as much as possible, perform a cleaning following the above procedure right after measuring and especially after measuring in a highly concentrated environment (100 CPM or higher) or after performing a long-term continuous measurement.

>>> If you leave the instrument without cleaning, the remaining dust will become deposited inside the optical system, which can deteriorate the measurement accuracy and may affect accurate calibration.

* Perform cleaning in a clean atmosphere.

If you perform a cleaning in a dirty environment, it can cause discrepancies. Therefore, make sure to perform a cleaning in a clean environment.

2.4 Calibration

In order to ensure accuracy you should perform a calibration before use.

(When measuring all day, please perform calibration before a measurement.)

For calibration there are background adjustments and sensitivity adjustments (SPAN).

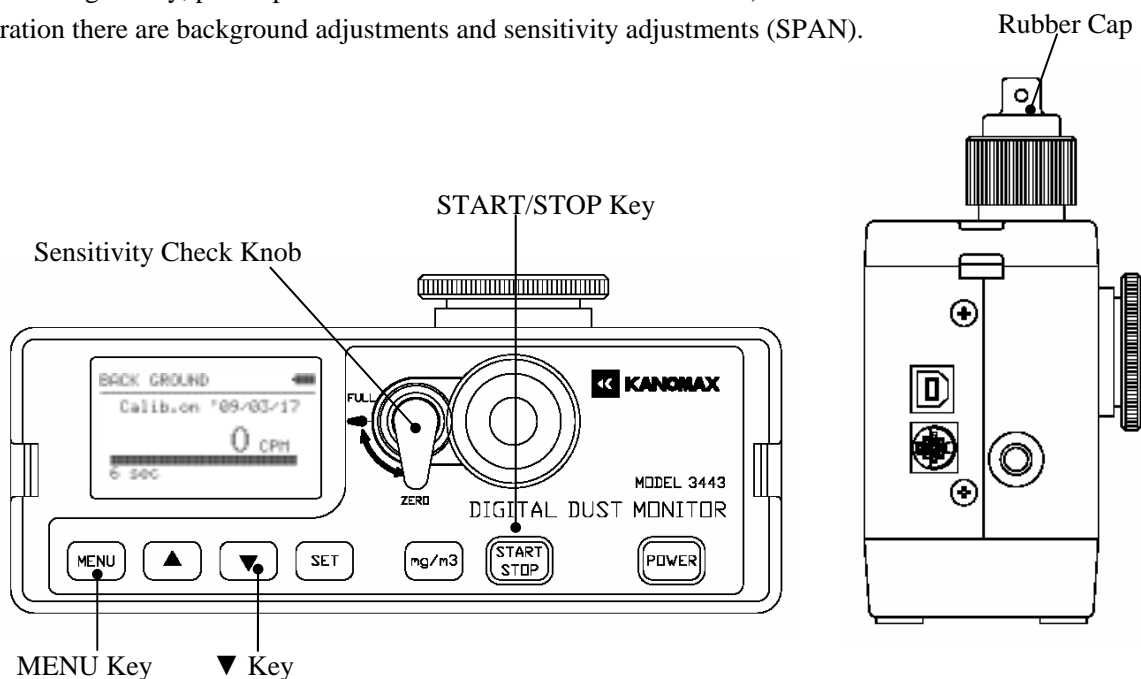

- (1) Going to CALIBRATION Mode from MENU Key.
- (2) To perform an accurate calibration make sure that the instrument is acclimatized to the ambient temperature of the place where the calibration work is performed. (Leave the instrument in the environment at least for 20 minutes.) An accurate calibration cannot be performed without sufficient warm-up operation.
- (3) Leave the rubber cap on the inlet.
- (4) Turn the Sensitivity Check Knob to the “ZERO” side when adjusting BACK GROUND, and to the “FULL” side when performing SPAN CALIBRATION.
- (5) Press [MENU] key to display the MENU screen.
- (6) Press [▼] key (or [▲] key) to move the cursor to “CALIBRATION”. Then press [SET] key to display the CALIBRATION screen. (See [3.4.5 Calibration](#))
- (7) Perform the background adjustment first followed by the sensitivity adjustment.
- (8) After calibration is done following the above procedure, move the Sensitivity Check Knob back to the “ZERO” side.

- * After using the instrument under harsh conditions (high concentration) or when using the instrument frequently, be sure to perform a calibration prior to measurement. Before performing a calibration, make sure that the instrument is acclimatized to the ambient temperature. (Leave the instrument in the calibration environment for at least 20 minutes.) An accurate calibration cannot be performed without sufficient warm-up operation.
- * If calibration cannot be performed properly, a “CALIBRATION ERROR” will be displayed on the screen. If this is the case, start from cleaning again.

Calibration date is updated after “SPAN CALIBRATION”. It doesn’t track the date for “BACK GROUND” calibration.

3. Display Description and Operation Procedure

3.1 Boot Screen

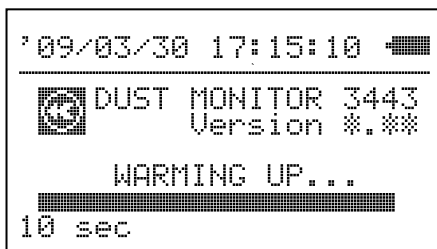

Press [POWER] button to turn ON the instrument. Then the boot screen will be displayed and start warming up for 10 seconds.

On the screen the version information and remaining time for warming up will be displayed.

3.2 Initial Screen

After the warm-up, the screen will be displayed as below.

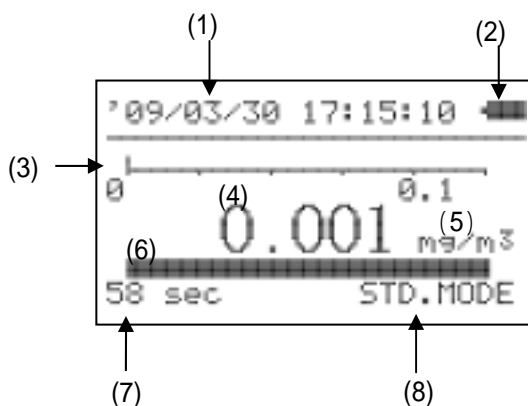

<Display Description>

- (1) Date & Time
- (2) Remaining battery level
(For details, please refer to [2.1 Setting batteries or AC adapter.](#))
- (3) Relative concentration bar (instantaneous value)
- (4) Indicated value
- (5) Unit
- (6) Time graph display while measuring
Once a measurement starts, the bar graph will be updated. When the measurement finishes, the bar graph will disappear.
In Manual Mode the graph will not be displayed.
- (7) Remaining measurement time
Once a measurement starts, the remaining time will be displayed while the bar graph is being updated.
In Manual Mode the elapsed time will be displayed.
- (8) Measurement mode
The selected measurement mode will be displayed.
Standard Mode: STD. MODE
Free Setting Mode: FRE. MODE
Manual Mode: MANUAL
Calculation Mode: CALC. MODE

<Operation>

- [START/STOP] Key: To start a measurement or to halt a measurement while measuring
To stop a measurement in Manual Mode
To end a measurement, press and hold [START/STOP] key for approximately 2 seconds.
- [mg/m³] Key: Press this button to convert unit between “mg/m³” and “CPM”.
- [MENU] Key: To move to the menu screen. Refer to [3.4 MENU.](#)

<Measurement Mode>

There are four different measurement modes. You can select a measurement mode on the menu screen.

Refer to **3.4.1 Measurement Mode** and **3.4.2 Calculation Mode**.

- 1) Standard Mode: Perform a measurement based on a pre-selected measurement time. You can select a measurement time from 6sec, 10sec, 30sec, 1min, 2min, 3min, 5min, 10min or TWA.
- 2) Free Setting Mode: Perform a measurement based on the pre-set measurement time. The settable measurement time is 1 ~ 59 sec or 1 ~ 99 min.
- 3) Manual Mode Manually start and stop a measurement. After starting a measurement, press [START/STOP] button to finish a measurement.
- 4) Calculation Mode: Repeat measuring based on the set conditions. The measurement result is saved in the memory.

The conditions to be set are;

- Date and time to start a measurement
- Measurement time
- Number of measurements

To view the stored data, go to the menu screen. Refer to **3.4.3 Data Display**.

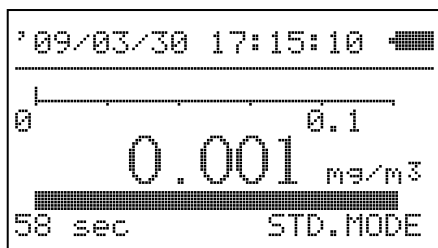
3.3 Screen While Measuring

During a measurement the integrated amount of particles is displayed as an indicated value, and the bar graph indicates the instantaneous value of relative concentration (CPM: Count Per Minute). The measurement time bar graph and the remaining time display indicate the remaining time of the measurement. When the bar graph display disappears, the measurement is finished.

This instrument's measurable count number is 0 ~ 999,999. If the count number exceeds this measurable range, "OVER" will be displayed on the screen.

- * When "OVER" is displayed on the screen, the value cannot be converted even if you press [mg/m³] button.
- * After measuring high concentration where "OVER" is displayed or measuring for a prolonged time, be sure to perform a cleaning to keep the inside optical system cell clean.



In MANUAL Mode the elapsed time is displayed.



In CALCULATION Mode, [the number of measurements performed / total number of measurements] will be displayed where the selected measurement mode is displayed in other modes.

<Operation>

- [START/STOP] Key: To stop a measurement
To finish a measurement in MANUAL Mode
- [▲] [▼] Key: To display a graph in CALCULATION Mode

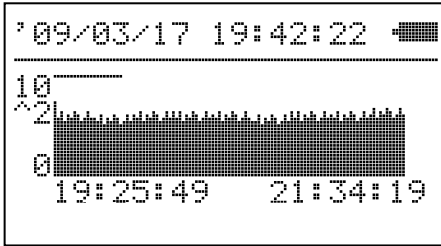

In Calculation Mode the measurement result can be displayed successively on the graph.

The vertical axis indicates CPM and the horizontal axis indicates measurement time.

Up to 110 data points can be displayed. Once the number of data points exceeds 110, the graph will be scrolled so that the latest 110 data points will be displayed.

When all of the measurements finish and the graph is displayed, it will go back to the initial screen automatically.

<Operation>

[▲][▼] Key:

[MENU] Key:

To go back to the screen to display numeric value

When all measurement finishes in graph display mode, press [MENU] key to go back to the screen displaying numeric values.

3.4 MENU

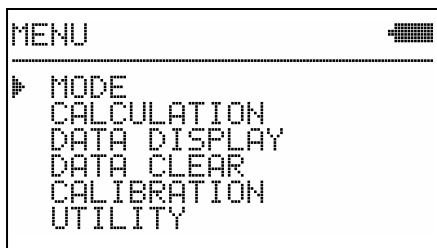

Press [MENU] key on the initial screen to display the menu screen.

On the menu screen you can select the followings;

MODE: Measurement Mode

To set a measurement mode => [3.4.1 Measurement Mode](#)

CALCULATION: Calculation Mode

To set calculation mode and to start a measurement

=> [3.4.2 Calculation Mode](#)

DATA DISPLAY

To display measurement data saved in the memory of the instrument on the screen

=> [3.4.3 Data Display](#)

DATA CLEAR

To delete measurement data saved in the memory of the instrument

=> [3.4.4 Deleting Data](#)

CALIBRATION

To perform background adjustment and sensitivity adjustment

=> [3.4.5 Calibration](#)

UTILITY

To perform cleaning and calibration and to configure each setting

=> [3.4.6 Utility](#)

<Operation>

- | | |
|-------------|---|
| [MENU] Key: | To go back to the initial screen |
| [▲][▼] Key: | To move the cursor up and down |
| [SET] Key: | To display the screen that is indicated by the cursor |

3.4.1 Measurement Mode

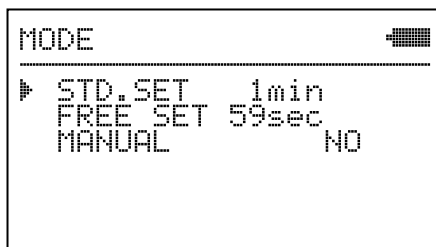

Select "MODE" on the menu screen to display the screen shown on the left.

On this screen, select one measurement mode out of three options.

The options are;

STD. SET: Standard Mode

FREE SET: Free Setting Mode

MANUAL: Manual Mode

Move the cursor up and down by using [▲][▼] keys, and select the item by pressing [SET] key.

* Please note that unless you press [SET] key when [SAVE INFO] is pointed at by [▶] on the setting screen of the each mode, setting will not be saved.

A) Standard Mode (STD. MODE)



In the Standard Mode select the time from the pre-set measurement time. The selectable measurement time is 6 sec, 10 sec, 30 sec, 1 min, 2 min, 3 min, 5 min 10 min or TWA (Time Weighted Average) mode. While the measurement time is highlighted, you can change the time by using [▲] [▼] keys.

Measurement Time Transition

- 06sec**
- [▲] Key ↓ ↑ [▼] Key
- 10sec**
- [▲] Key ↓ ↑ [▼] Key
- 30sec**
- [▲] Key ↓ ↑ [▼] Key
- 01min**
- [▲] Key ↓ ↑ [▼] Key
- 02min**
- [▲] Key ↓ ↑ [▼] Key
- 03min**
- [▲] Key ↓ ↑ [▼] Key
- 05min**
- [▲] Key ↓ ↑ [▼] Key
- 10min**
- [▲] Key ↓ ↑ [▼] Key
- 06sec**

Move the cursor to STD. SET, and then press [SET] key to highlight the measurement time to configure the setting. Once a measurement time is selected, press [SET] key. The measurement time will stop being highlighted. Use [▲] [▼] keys to move the cursor to “SAVE INFO”, and press [SET] key to save the setting. Then a measurement screen will be displayed. To go back to a measurement screen before you complete the setting, press [MENU] key.

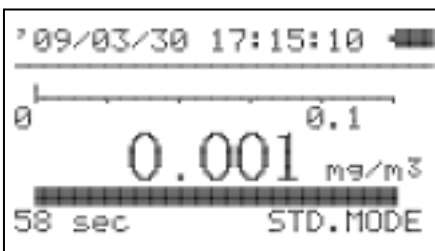

mg/m3 (Instantaneous Value)

<6 sec, 10 sec, 30 sec, 1 min, 2 min, 3 min, 5 min 10 min or TWA mode>
 A measurement is performed for the set measurement time. Press [START/STOP] key to start a measurement. After a measurement finishes, the measurement result will be displayed. The remaining measurement time will be indicated at the lower left and also indicated in the bar graph below the measurement value. You can stop a measurement before it completes by pressing and holding [START/STOP] key for about 2 seconds.

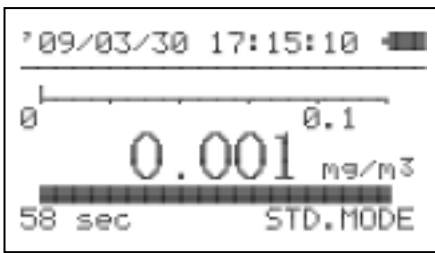

Mg/m3

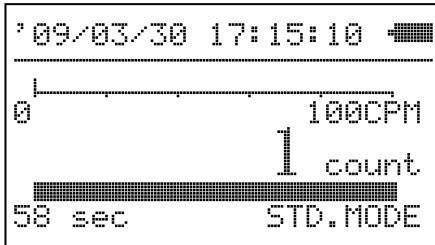

CPM(COUNT)

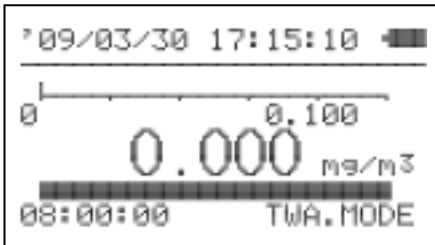

mg/m3 (Instantaneous Value)

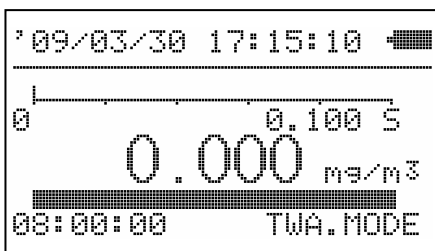
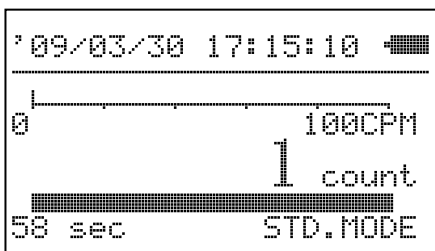

mg/m3 (T)

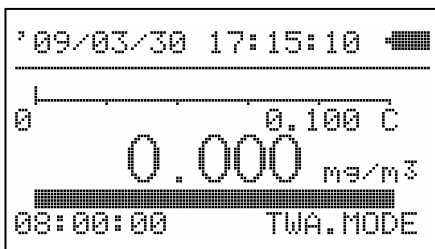

mg/m3 (S)

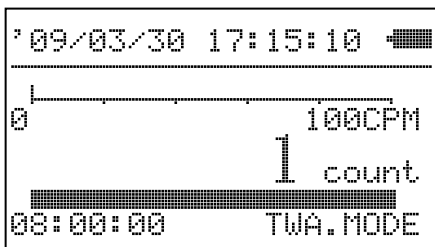

mg/m3 (C)

CPM(COUNT)

You can switch over the indicated value as described below by pressing [mg/m3] key in real time.

Switching over measurement value

mg/m3 (Instantaneous Value)

[mg/m3] key ↓

CPM (COUNT)

[mg/m3] key ↓

mg/m3 (Instantaneous Value)

<TWA Mode>

In TWA mode you can perform a measurement based on the settings referring to **H) TWA MODE** in **3.4.6 Utility**.

Press [START/STOP] key to start a measurement. After a measurement completes, the measurement result will be displayed. The remaining measurement time is indicated on the bottom of the screen and also shown in the bar graph.

You can forcibly finish a measurement by pressing and holding [START/STOP] key for about two seconds.

In TWA mode you can switch over the indicated value as described below by pressing [mg/m3] key during and after a measurement.

Switching over measurement value

mg/m3 (Instantaneous Value)

[mg/m3] key ↓

mg/m3 (TWA)

[mg/m3] key ↓

mg/m3 (STEL)

[mg/m3] key ↓

mg/m3 (C)

[mg/m3] key ↓

CPM (COUNT)

[mg/m3] key ↓

mg/m3 (Instantaneous Value)

B) Free Setting Mode

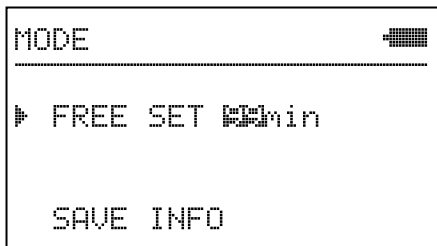

In Free Setting Mode you can set the measurement time in the range of 1~59 sec in increments of one second or in the range of 1 ~ 99 minutes in increments of one minute.

While a measurement time is highlighted, you can change it by using [▲] [▼] keys.

Measurement Time Transition

01sec

Press [▲] key to increase 1 sec ↓ ↑ Press [▼] key to decrease 1 sec

01min

Press [▲] key to increase 1 min ↓ ↑ Press [▼] key to decrease 1 min

99min

Move the cursor to “FREE SET”, and then press [SET] key to highlight the measurement time to configure the setting.

Once a measurement time is set, press [SET] key.

The measurement time will stop being highlighted.

Use [▲] [▼] keys to move the cursor to “SAVE INFO” and press [SET] key to save the setting. Once the setting is saved, it will go back to the measurement screen.

To go back to the measurement screen before you complete the setting, press [MENU] key.

C) Manual Mode

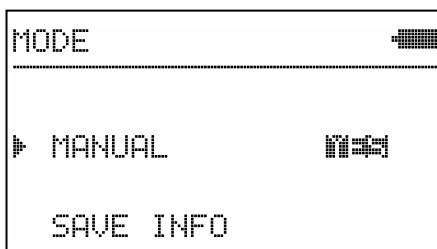

In Manual Mode you can finish a measurement any time by pressing [START/STOP] key.

When YES/NO is highlighted, you can select to measure in the Manual Mode or NOT by using [▲] [▼] keys. To perform a measurement in Manual Mode, select YES in the setting.

Move the cursor to “MANUAL” and press [SET] key to highlight it to configure the setting.

After selecting YES or NO, press [SET] key.

The selected item will stop being highlighted.

Move the cursor to “SAVE INFO” by using [▲] [▼] keys, and then press [SET] key to save the settings. Then it will go back to the menu screen.

To go back to the measurement screen before you complete the setting, press [MENU] key.

3.4.2 Calculation Mode

```

CALCULATION REC099934
┌ START DATE/TIME
│ 00/00/12/08
│ 17:55:00
│ SAMPLING TIME 99:59
│ No. TRIAL(N) 1000
│ SET TO START ID0011
└

```

Select “CALCULATION” mode on the menu screen to display the screen shown on the left.

In the CALCULATION MODE you can set date & time to start a measurement, sampling time and number of sampling trials.

Use [▲] [▼] keys to move the cursor to the item to be set. Then press [SET] key to configure each setting.

START DATE/TIME: Date & time to start a measurement

SAMPLING TIME: Sampling time (1 sec ~ 99 min 59 sec)

No. TRIAL (N): No. of sampling trials (1 ~ 30,000 times)

SET TO START: To start a measurement

To go back to the menu screen before you complete the setting, press [MENU] key.

A) Measurement Start Date & Time

```

┌ START DATE/TIME
│ 00/00/12/08
│ 00:00
└

```

Set each figure in the order of Year→Month→Date→Hour→Min→Sec if JP is selected for date mode. (Refer to **3.4.6 Utility B)Time Adjustment**)

Use [▲] key to increase the value of the highlighted item and [▼] key to decrease the value.

Press [SET] key to move the cursor to the next item.

After setting the second, the date and time will stop being highlighted, and now you can select the next item to be configured.

B) Sampling Time

```

┌ SAMPLING TIME 00:59
└

```

Set sampling time.

Use [▲] key to increase the value of the highlighted item and [▼] key to decrease the value. The settable range is 1 sec ~ 99 min 59 sec.

After setting the sampling time, press [SET] key. Then the time will stop being highlighted, and now you can select the next item to be configured.

C) The Number of Sampling Trials

```

┌ No. TRIAL(N) 1000
└

```

The number of sampling trials will be highlighted. Use [▲] to increase the value and [▼] key to decrease. The settable measurement cycle is up to 30,000 times.

Press [SET] key to complete setting. The set value will stop being highlighted, and now you can select the next item to be configured.

D) To Start a Measurement

```

┌ SET TO START ID0011
└

```

Press [SET] key to go back to the initial screen and the instrument will start stand-by for starting a measurement.

When the configured date and time comes, a measurement will start.

<Stand-by Screen>

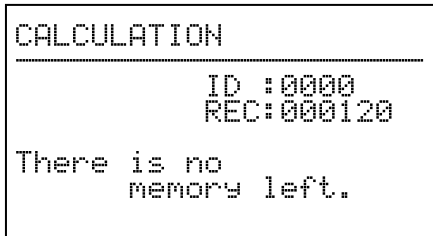
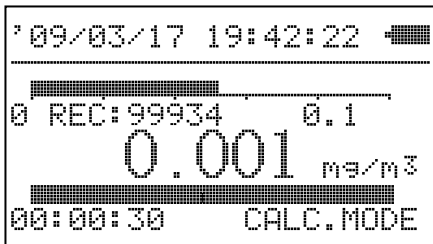

Press [SET] key to start stand-by for a measurement.
When the configured date and time comes, a measurement will start.

User also starts measurement manually by pushing START/STOP Key.

CALCILATOIN Mode shows the error message when the data storage is full. Make available space after deleting some data, and select CALCULATION Mode. (See 3.4.4 for Deleting Data)

<Screen While Measuring>

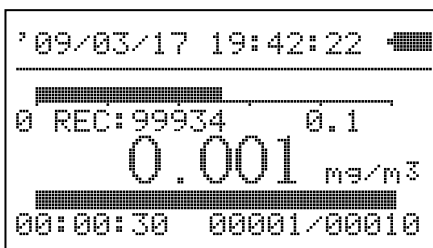

During a measurement use [▲] [▼] keys to change the numerical display to graph display. Press the key again to go back to the numerical display.

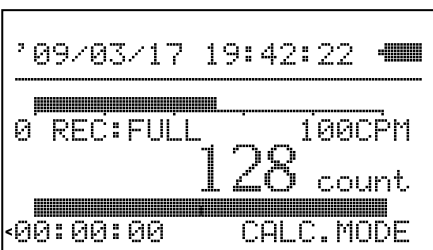

Measurement stops and shows "REC: FULL" when the data storage gets full. Measurements are saved until the point.

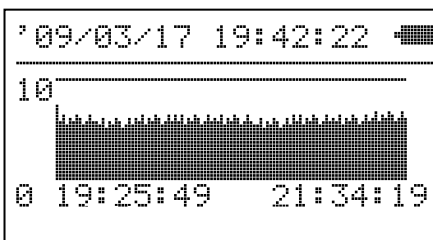

During a measurement use [▲] [▼] keys to change the graph display to count value display. Press the key again to display the graph.

Unit used in vertical axis: mg/m³

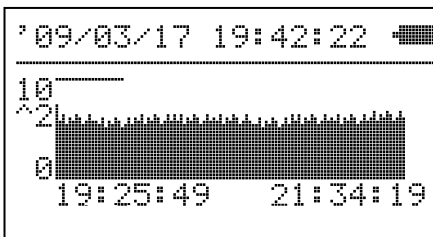

The unit selected on the numerical display applies to the vertical axis. The range changes as the measurement value increases in three steps.

Unit used in vertical axis: CPM

- * mg/m³
 - 0-0.1mg/m³ range
 - 0-1mg/m³ range
 - 0-10mg/m³
- * CPM
 - 0-100CPM range (10²)
 - 0-1000CPM range (10³)
 - 0-10000CPM range (10⁴)

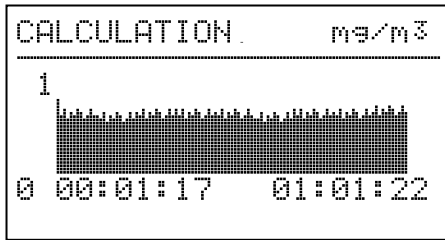

Press [MENU] key

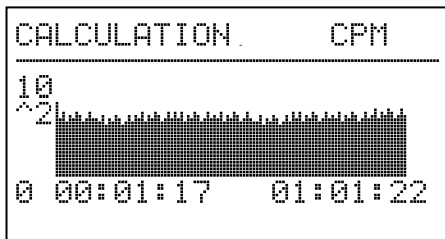

3.4.3 Data Display

DATA DISPLAY			
P0001	09/03/30	18:15	
P0002	09/03/30	18:16	
P0003	09/03/30	19:00	
P0004	09/03/30	19:01	
P0005	09/03/30	19:30	

<data list display screen>

DATA DISPLAY		CPM
P0001	09/03/30 19:00	
TIME:	00:01	K=0.0010
CYCLES:	60	
MAX:	1234	
MIN:	123	
AVE:	1000	

DATA DISPLAY		mg/m ³
P0001	09/03/30 19:00	
TIME:	00:01	K=0.0010
CYCLES:	60	
MAX:	1.234	
MIN:	1.23	
AVE:	1.000	

DATA DISPLAY		CPM
P0001	09/03/30 19:00	
00:01:17		1450
00:01:18		1449
00:01:19		1450
00:01:20		1451
00:01:21		1450

After a measurement, use [▲] [▼] keys to scroll the graph display.

The number of data points that can be displayed in one screen is 110.

To switch the graph display to the count display after a measurement, press [MENU] key.

Select DATA DISPLAY on the menu screen to display the data list display screen shown on the left.

A list of data points taken in the CALCULATION MODE will be displayed.

Use [▲] [▼] keys to move the cursor to the data point you want to display, and press [SET] key to select it.

Press [MENU] key to go back to the menu screen.

The calculation result of the selected data point is displayed.

TIME: Measurement time (MM:SS)
 K: K Factor
 CYCLES: Number of measurement cycles
 MAX: Maximum concentration
 MIN: Minimum concentration
 AVE: Average concentration

Press [SET] key to display a list of each measurement data.

Press [MENU] key to go back to the previous screen.

Each measurement data will be displayed.

A measurement data is displayed in one line in the order of the measurement time and concentration (unit: CPM).

Press [▲] [▼] keys to scroll the screen.

Press [SET] key to display a graph.

Press [MENU] key to go back to the data list display screen.

DATA DISPLAY		mg/m ³
P0001	'09/03/30	19:00
00:01:17		1.450
00:01:18		1.449
00:01:19		1.450
00:01:20		1.451
00:01:21		1.450

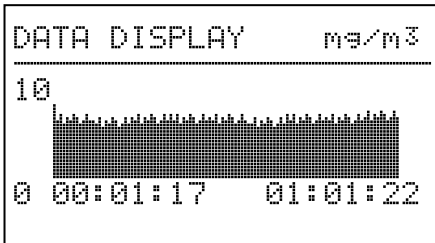

Time-line graph of the measurement data will be displayed.

Up to 110 data points can be displayed on one screen.

The unit selected on the numerical display applies to the vertical axis.

The range changes as the measurement value increases in three steps.

* mg/m³

0-0.1mg/m³ range

0-1mg/m³ range

0-10mg/m³

* CPM

0-100CPM range (10²)

0-1000CPM range (10³)

0-10000CPM range (10⁴)

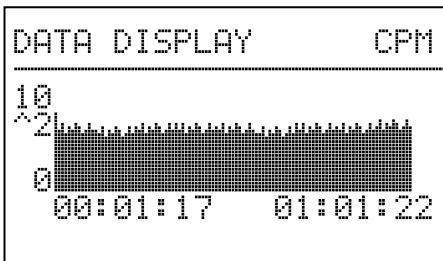

Press [▲] [▼] keys to scroll the screen.

Press [MENU] key to go back to the data list display screen.

3.4.4 Deleting Data

```

DATA CLEAR
└─ CLEAR START : 0001
      END      : 0001
      SET      : NO
ALL CLEAR    NO
  
```

Select DATA CLEAR on the menu screen to display the screen shown on the left.

You can select to delete either only the selected data or all measurement data.

Press [\blacktriangle] [\blacktriangledown] keys to move the cursor and press [SET] key to select the item.

Press [MENU] key to go back to the menu screen.

A) To Delete Only the Selected Measurement Data

```

└─ CLEAR START : 0001
      END      : 0001
      SET      : NO
  
```

Set the first and the last measurement data numbers to be deleted.

The item to be set will be highlighted.

Press [\blacktriangle] key to increase the figure and [\blacktriangledown] key to decrease the figure.

Press [SET] key to fix the value. The set value will stop being highlighted.

After setting the data number, YES/NO for SET will be highlighted. To perform deletion, select [YES] using [\blacktriangle] [\blacktriangledown] keys and then press [SET] key. Then the data in the selected range will start to be deleted.

When the data deletion completes, the display will go back to the DATA CLEAR screen where you can select to delete only selected data or all data.

```

└─ CLEAR START : 0001
      END      : 0001
      SET      : NO
ALL CLEAR    NO
      DATA Cleared
  
```

“DATA Cleared” will appear after deleting data.

To go back to the MENU screen, press [MENU] key.

B) To Delete All Measurement Data

```

└─ ALL CLEAR    YES
  
```

YES/NO will be highlighted.

To perform deletion, select [YES] using [\blacktriangle] [\blacktriangledown] keys and then press [SET] key. Then all of the data will start to be deleted.

When the data deletion completes, the display will go back to the DATA CLEAR screen where you can select to delete only selected data or all data.

```

└─ CLEAR START : 0001
      END      : 0001
      SET      : NO
ALL CLEAR    NO
      DATA Cleared
  
```

“DATA Cleared” will appear after deleting data.

To go back to the MENU screen, press [MENU] key.

3.4.5 Calibration

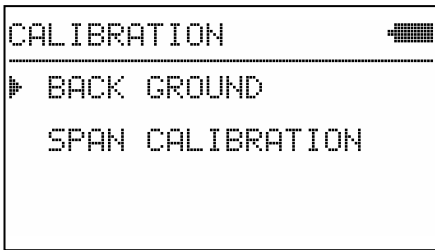

To perform an accurate calibration make sure that the instrument is acclimatized to the ambient temperature of the place where the calibration work is performed. (Leave the instrument for at least 20 minutes.)

An accurate calibration cannot be performed without sufficient warm-up operation

To calibrate the instrument → Refer to **2.4 Calibration**.

Before starting calibration, perform cleaning. Leave the rubber cap on the inlet.

Move the sensitivity check knob to the “ZERO” side.

Perform the background adjustment first followed by the sensitivity adjustment.

Press [▲] [▼] keys to move the cursor to the item to be set, and then press [SET] key to configure the setting.

BACK GROUND: Background Adjustment

SPAN CALIBRATION: Sensitivity Adjustment

To go back to the MENU screen before completing the setting, press [MENU] key.

<Background Adjustment>



To perform the background adjustment

Press [START/STOP] key to start a measurement.

[START/STOP] Key

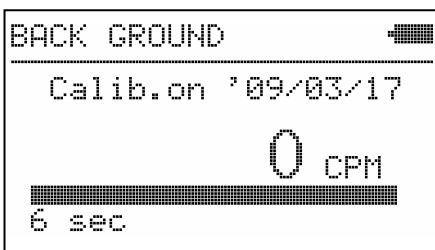

A measurement will be performed for 6 seconds. During a measurement the instantaneous value of the background (CPM) will be displayed.

The remaining measurement time will be displayed on the bottom of the display.

The measurement will finish in 6 sec.

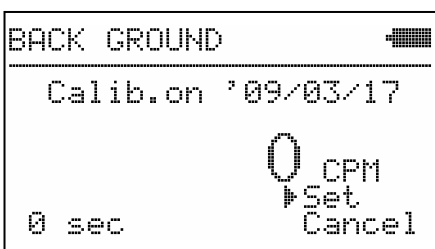

When a measurement is finished, the average background value (CPM) at the time will be displayed.

To perform the background adjustment with this value, select SET. If not, select CANCEL.

Press [▲] [▼] keys to move the cursor, and press [SET] key to configure the setting. After the adjusted value is displayed for about 2 seconds, the unit will go back to the CALIBRATION screen.

<Sensitivity Adjustment (SPAN)>



[START/STOP] Key

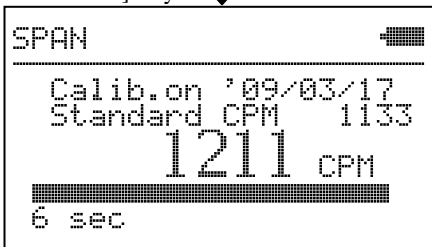

The measurement will finish in 6 sec.

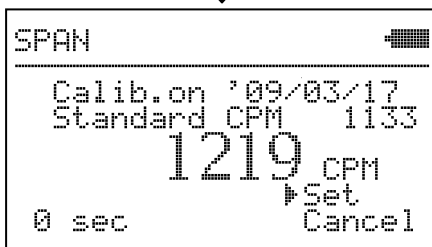

To perform sensitivity adjustment

Before performing a sensitivity adjustment, be sure to do the background adjustment. After background adjustment, turn the sensitivity knob to the “FULL” side.

The date of the last sensitivity adjustment and standard count value are displayed.

Press [START/STOP] key to start a measurement.

A measurement will be performed for 6 seconds. During a measurement the instantaneous value of the standard count (CPM) will be displayed.

The remaining measurement time will be displayed on the bottom of the display.

The standard count value (CPM) at the time is displayed on the screen.

To perform Sensitivity Check with this value, select SET. If not, select CANCEL.

Press [▲][▼] keys to move the cursor, and press [SET] key to configure the setting. After the adjusted value is displayed for about 2 seconds, the display will go back to the CALIBRATION screen.

*Calibration date is updated after “SPAN CALIBRATION”. It doesn’t track the date for “BACK GROUND” calibration.

- * To perform an accurate calibration make sure the instrument is acclimatized to the ambient temperature of the place where the calibration work is performed. (Leave the instrument at least for 20 minutes.) An accurate calibration cannot be performed without sufficient warm-up operation.

- * **Background Adjustment**

Performing Background Adjustments in a highly concentrated environment or making an operation error will influence a measurement value significantly. Therefore, please pay attention when performing a background adjustment.

When the background adjustment value differs from the manufacturer’s calibrated value by ± 20 counts, it is considered as an error and the adjustment value cannot be stored. If that is the case, please contact your sales representative or KANOMAX service center.

- * **Sensitivity Adjustment**

Just as the Background Adjustment, performing Sensitivity Adjustment in the highly concentrated environment or making an operation error will influence a measurement value significantly. Therefore, please pay attention when performing a background adjustment.

When the sensitivity adjustment range differs from the manufacturer’s calibrated range by more than $\pm 20\%$, the adjustment value cannot be stored. If that is the case, please contact your sales representative or KANOMAX service center.

3.4.6 Utility

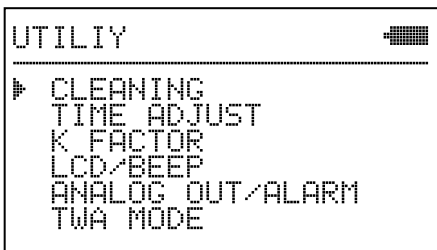

Select UTILITY on the menu screen to display the screen shown on the left.

In UTILITY you can perform preparation for a measurement and configure settings.

Press [▲] [▼] keys to move the cursor to the item to be set, and then press [SET] key to configure the setting.

▶ **CLEANING**

TIME ADJUST: Time Setting

K FACTOR: The Mass Concentration Conversion Coefficient setting

LCD/BEEP: LCD & Beep Sound setting

ANALOG OUT/ALARM: Analog Output & Alarm setting

TWA MODE: TWA Measurement Mode Setting

To go back to the MENU screen, press [MENU] key.

A) **Cleaning**

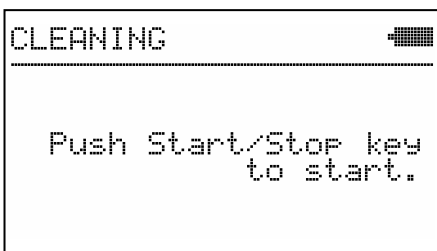

To clean the instrument → Refer to **2.3 Cleaning**.

To start cleaning, put the rubber cap on the inlet. Confirm that the sensitivity check knob is at the “ZERO” side.

Press [START/STOP] key to start cleaning.

Press [MENU] key to go back to the UTILITY screen.

[START/STOP] Key

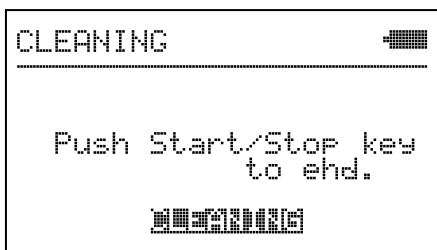

Push “START/STOP” Key to stop cleaning. Push MENU Key to go back to UTILITY Menu.

Perform cleaning for approximately 5 minutes.

* Required cleaning time is different depending on the use environment.

* If an error occurs during calibration and background adjustment after cleaning for more than 10 minutes, the internal cleaning is required. Please contact your distributor or KANOMAX service center.

B) Time Adjustment

```

TIME ADJUST
-----
▶ STYLE:  JP
  DATE:  2008/12/08
  TIME:   00:00:00

SAVE INFO

```

To configure the date format and time setting

STYLE: Date Format Selection

DATE: Date Setting

TIME: Time Setting

Press [▲] [▼] keys to move the cursor, and press [SET] key to select it.

Press [MENU] key to go back to the UTILITY screen.

<Date Format Selection>

```

▶ STYLE:  JP

```

For the date format select one among JP, US or EU. Each format is as follows;

JP: YYYY/MM/DD

US: MM/DD/YYYY

EU: DD/MM/YYYY

YYYY: Year, MM: Month, DD: Date

JP/US/EU will be highlighted.

Press [▲] [▼] keys to change the setting.

Press [SET] key to fix the setting and the set item will stop being highlighted. The display will go back to the screen where you can select the item to be configured.

To go back to the UTILITY screen, press [MENU] key.

<Date Setting>

```

▶ DATE:  2008/12/08

```

Configure the value in the order of Year → Month → Date. (This is in case of selecting JP for the data display format. The setting order differs depending on the data display format.)

Use [▲] key to increase the figure of the highlighted item and [▼] key to decrease it.

Use [SET] key to highlight the next item.

Once the date setting is complete, all items will stop being highlighted and the display will go back to the screen where you can select the item to be configured.

<Time Setting>

```

▶ TIME:   00:00:00

```

Configure the value in the order of Hour → Minute → Second.

Use [▲] key to increase the figure of the highlighted item and [▼] key to decrease it.

Use [SET] key to highlight the next item.

After setting second, the time will stop being highlighted, and the display will go back to the screen where you can select the item to be configured.

<To Store the Setting>

```

▶ SAVE INFO

```

Press [SET] key to store the setting and go back to the UTILITY screen.

C) K Factor

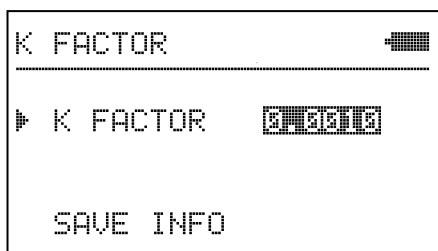

Set the factor of Mass Concentration Conversion Coefficient (K FACTOR).

Move the cursor to K FACTOR and press [SET] key to highlight the value. Press [▲] key to increase by 0.0001 and [▼] key to decrease by 0.0001.

The range of the settable factor is 0.0001 ~ 0.0099.

Select a value for K FACTOR, and then press [SET] key.

The factor will stop being highlighted.

Use [▲] [▼] keys to move the cursor to SAVE INFO, and then press [SET] key to store the setting and go back to the UTILITY screen.

To stop configuring the setting and go back to the UTILITY screen, press [MENU] key.

- * The settable factor range is $K = 0.0001 \sim 0.0099$.
- * Before shipping, $1 \text{ CPM} = 0.0010 \text{ mg/m}^3$ is assigned for calibration particle. Therefore, K factor is set to 0.0010.
- * Example:
 $K = 0.0010: 100 \text{ CPM} \rightarrow 0.1 \text{ mg/m}^3$
 $K = 0.0020: 100 \text{ CPM} \rightarrow 0.2 \text{ mg/m}^3$

To convert the value indicated by the instrument into the mass concentration (mg/m^3) the Mass Concentration Conversion Coefficient (K factor) shall be obtained. The K-factor is determined by performing a parallel measurement based on a filtration instrument which uses particle size analyzer.

How to obtain K-factor is as follows:

Prepare the instrument (Model 3443) and a filtration instrument which uses a particle size analyzer. When placing these two units, keep their suction direction and the height of the suction points same. Select "MANUAL" mode on the instrument and start measuring using those units at the same time. To calculate K-factor, divide the mass concentration (C) measured by the filtration instrument by the count per minute (R). In order to obtain (R) divide the count you get using this instrument by the measurement time (min).

$$K = C/R$$

To convert the factor into mass concentration (mg/m^3), multiply the K-factor by CPM that you obtain at each measurement point using this instrument.

- * The ranges of corresponding value of mass concentration are 0 to 10,000 counts. The counts above the range won't be converted accurately.

D) LCD / Beep Sound Setting

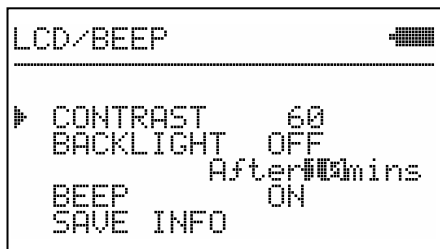

You can set the screen contrast, the backlight-out time and to turn ON/OFF the beep sound.

- CONTRAST: To set contrast of the display
- BACKLIGHT OFF: To set the backlight-out time
- BEEP: To turn ON/OFF beep sound

Press [▲] [▼] keys to move the cursor, and then press [SET] key to select it.

Press [MENU] key to go back to the UTILITY screen.

<Contrast of the display>



The numeric value for the screen contrast will be highlighted.

Press [▲] key to increase the value by 1 and [▼] key to decrease the value by 1.

The range of the contrast is 20 ~ 54.

After setting the value, press [SET] key.

Then the value will stop being highlighted, and now you can select the next item to be configured.

<Backlight-Off Time>



For battery saving purpose, set the time to activate the automatic backlight OFF function when the instrument is not in operation.

The automatic backlight OFF time will be highlighted.

Press [▲] key to increase the numeric figure and press [▼] key to decrease the figure.

The settable range for backlight OFF time is 1 ~ 99 min or you can set to turn ON the backlight all the time.

After setting the value, press [SET] key.

Then the value will stop being highlighted, and now you can select the next item to be configured.

Press [▼] key when the value is 1 to select “Always ON” setting to turn the backlight ON all the time.

To select “Always ON”, you can also press [▲] key when the value of 99 is selected.

After **1** min

[▲] key to increase by 1 min ↓ ↑ [▼] key to decrease by 1 min

After **99** mins

[▲] key ↓ ↑ [▼] key ←

Always ON

<Beep Sound Setting (On/OFF)>

You can set whether to activate the beep ON or OFF for key operation.
When ON/OFF setting is highlighted, you can change the setting by using [▲] [▼] keys.
After setting, press [SET] key.
The setting will stop being highlighted, and now you can select the next item to be configured.

<Saving the settings>

Press [SET] key to save the settings and go back to the UTILITY screen.

E) Analog Output & Alarm Setting

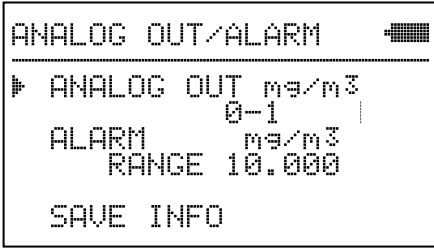

Set the analog output and alarm range.

ANALOG OUT: Analog Output Setting
ALARM: Alarm ON/OFF Setting

Press [▲] [▼] keys to move the cursor and select the item pressing [SET] key.

Press [MENU] key to go back to the UTILITY screen.

<Analog Output Setting>

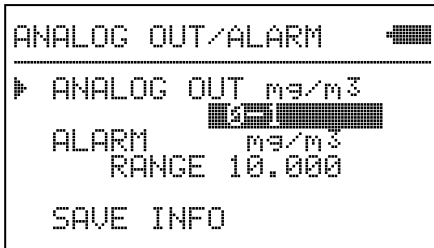

Set the relation between the measured concentration value (mg/m3) / measured relative concentration value (CPM) and the voltage output from the output terminal.

The concentration range which corresponds to the output of 0 ~ 1 V will be highlighted.

0-1 mg/m3: When the concentration is 1mg/m3, 1V is output.

0-10 mg/m3: When the concentration is 10mg/m3, 1V is output.

AUTO mg/m3: The output voltage will be switched over automatically;

When the concentration is 0~1mg/m3, 0~1V is output.

When the concentration is 1~10mg/m3, 0.1~1V is output.

0-1,000 CPM: When the concentration is 1,000 CPM, 1V is output.

0-10,000 CPM: When the concentration is 10,000 CPM, 1V is output.

AUTO CPM: The output voltage will be switched over automatically;

When the concentration is 0 ~ 1,000 CPM, 0 ~ 1V is output.

When the concentration is 1,000~10,000 CPM, 0.1~1V is output.

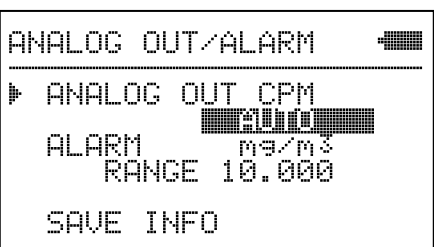
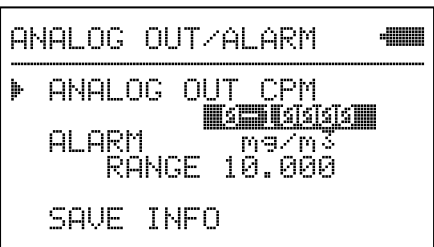
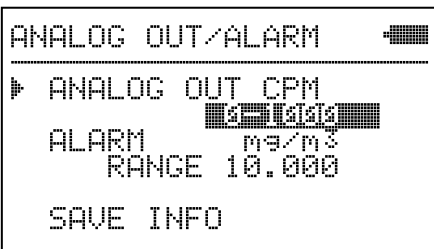
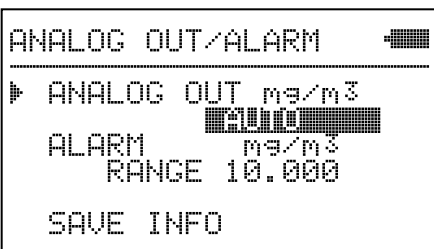
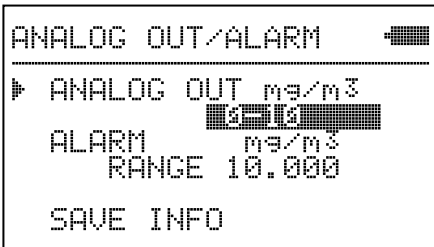

Use [▲] [▼] keys to change the setting.

- 0-1 mg/m3**
- [▲] Key↓ ↑ [▼] Key
- 0-10 mg/m3**
- [▲] Key↓ ↑ [▼] Key
- AUTO mg/m3**
- [▲] Key↓ ↑ [▼] Key
- 0-1000 CPM**
- [▲] Key↓ ↑ [▼] Key
- 0-10000 CPM**
- [▲] Key↓ ↑ [▼] Key
- AUTO CPM**

After setting the value, press [SET] key.

The setting will stop being highlighted and the screen will go back to the display where you can select the item to be configured.

- (1) Data Update Interval: The output data is output every one second.
- (2) Load Impedance: 1 KΩ or higher
- (3) Output Cable: Please purchase our optional output cable (3442-01).

Method to output measurement data (in case of analog output)	Explanation
	Concentration value (mg/m ³ or CPM) will be converted to the output voltage.

* Use the dedicated output cable (3442-01) sold separately.

<Alarm Setting>

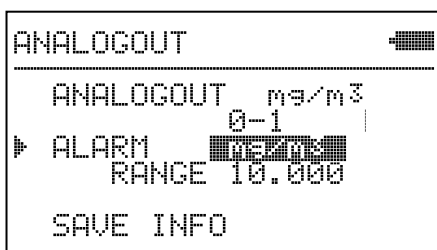

When the reading exceeds the set concentration value during a measurement, the alarm will be turned ON. And when the reading becomes lower than the set concentration value, the alarm will be OFF. This alarm will be activated only during a measurement. (Even if the alarm is ON during a measurement, it will be OFF once the measurement finishes.)

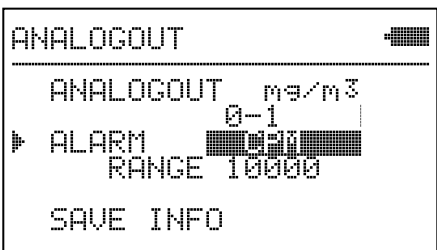

When alarm mode setting is OFF, the alarm function is not activated. Use [▲] [▼] keys to change the mode setting.

mg/m3

[▲] key to CPM setting ↓ ↑ [▼] key to mg/m3 setting

CPM

[▲] key to OFF setting ↓ ↑ [▼] key to CPM setting

OFF

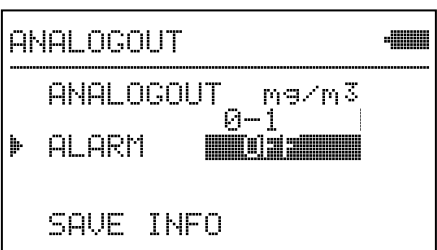

After setting the alarm mode, press [SET] key.

The RANGE setting value will be highlighted. Use [▲] [▼] keys to set the value. After setting, press [SET] key. Then the RANGE setting value will stop being highlighted.

10.000

[▼] key to decrease ↓ ↑ [▲] key to increase

9.999

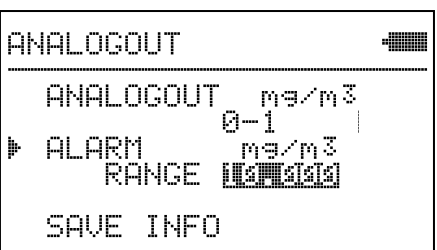

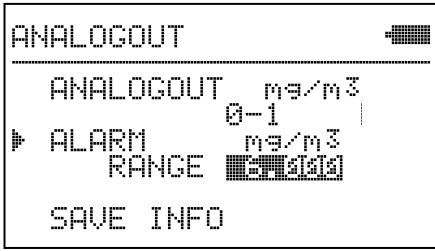

The range setting is also required in CPM mode as well.

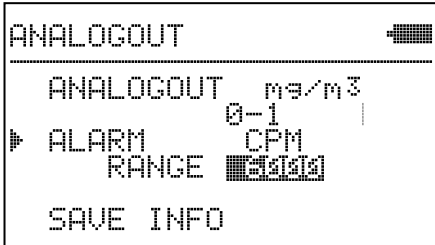
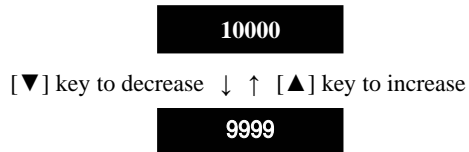

Use [▲][▼] keys to move the cursor and select [SAVE INFO]. Then press [SET] key.

The set value will be saved and the screen will go back to the UTILITY screen.

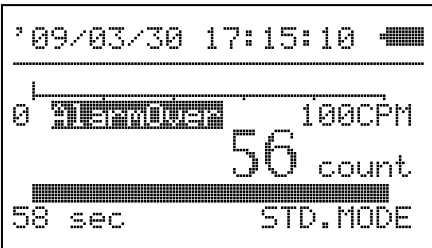

“AlarmOver” will appear when measurement hits over the range

- (1) Data Update Interval: The output data is updated every one second.
- (2) Effective Range of the Output: From when a measurement starts until the measurement finishes.
- (3) Output Format, Spec: Photocoupler Output (no-voltage contact output: collector emitter)
Model: TLP127
Maximum Applied Voltage: DC300V
Maximum Current: 150mA
- (4) Output Cable: Please use the optional analog / alarm output cable (3442-01).

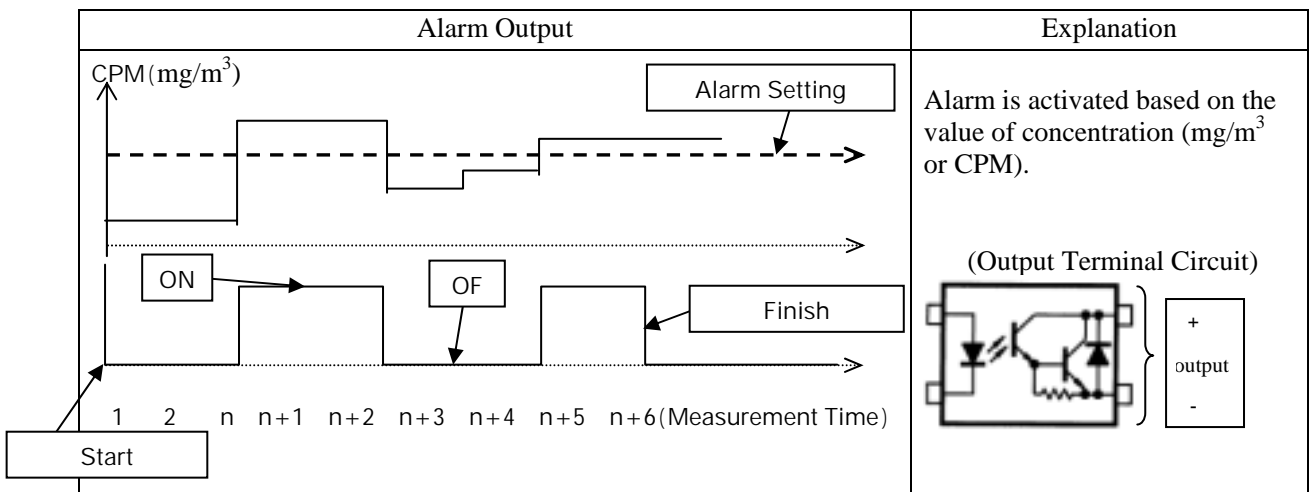

* Use the dedicated output cable (3442-01) sold separately.

F) Pulse Output

With this instrument the pulse that corresponds to CPM value (instantaneous value) can be output.
Connect the output cable sold separately.

- (1) Pulse Frequency Update Interval: The output data is updated every one second.
- (2) Pulse Range: 0.0166 Hz – 166.6 Hz (1-10,000 CPM)
DUTY 50%
- (3) Output Format, Spec: Photocoupler Output (no-voltage contact output: collector emitter)
Model: TLP127
Maximum Applied Voltage: DC300V
Maximum Current: 150mA
- (4) Output Cable: Please purchase our optional output cable (3442-01).

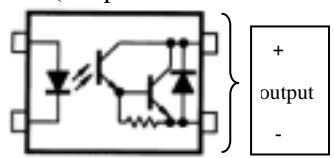
Pulse Output		Explanation
CPM (Instantaneous Value)	Pulse Frequency	The pulse equivalent to the CPM value (instantaneous value) is output. (Output Terminal Circuit) 
1 CPM	0.0166 Hz	
60 CPM	1 Hz	
600 CPM	10 Hz	
6,000 CPM	100 Hz	
10,000 CPM	166.6 Hz	
* The pulse output is more than 1 CPM and the resolution is 1 CPM. When CPM is 0 CPM, there is no pulse output.		

* The CPM value (instantaneous value) used for pulse output differs from the COUNT value on the LCD display.
* Use the dedicated output cable (3442-01) sold separately.

G) Output Cable (3442-01) -external appearance-

This is the dedicated cable for analog output, pulse output and alarm output. This is an option at the time of purchase only.

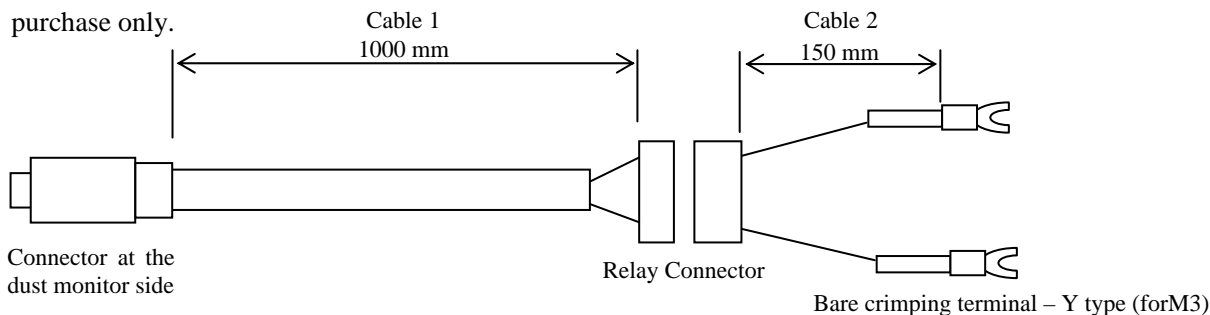

* Supplied as a set of cable 1 and cable 2.

Signal Name		Wiring Color Cable 2	Marking
Analog Output	Sig	Red	ANALOG +
	GND	Black	ANALOG -
Alarm Output	+	White	ALARM +
	-	Blue	ALARM -
Pulse Output	+	Yellow	PULSE +
	-	Green	PULSE -

H) TWA MODE

```

TWA MODE
-----
▶ TWA TIME(m)   08:00
  TWA VALUE     0.500
  STEL VALUE     0.800
  C VALUE       1.000
  ALARM SET     ON
  SAVE INFO

```

If you select TWA on the menu screen, the screen shown on the left will be displayed.

You can configure TWA measurement setting and alarm setting.

TWA TIME (m):	Measurement time setting (1 min ~ 48 hrs, settable by minutes)
TWA VALUE:	Time-weighted average (0.001 ~ 10.000, STEL>TWA)
STEL VALUE:	Short-term exposure limit (0.001 ~ 10.000, C>STEL>TWA)
C VALUE:	Upper limit tolerance (0.001 ~ 10.000, C>STEL)
ALARM SET:	Alarm ON/OFF setting
SAVE INFO:	Save settings

Use [▲][▼] keys to move the cursor and press [SET] key to set it.

Press [MENU] key to go back to the UTILITY screen.

If an error is detected in the settings for TWA VALUE, STEL VALUE, C VALUE, [ERROR!] will be indicated on the lower right of the screen for two seconds.

<Time-weighted average (TWA)>

Input Range: The short term exposure limit (STEL) or less in the range of [0.001-10.000] mg/m³

Time-weighted average (TWA) is the time-weighted average concentration for the regular working hours of 8 hours a day and 40 hours a week. When the average concentration (mg/m³) from the beginning to the ending of the TWA mode measurement exceeds this set value, an alarm will be activated.

The TWA measurement value is displayed in real time.

If the measurement time is less than 8 hours, the time length till the end of the measurement is subject to this measurement.

<Short term exposure limit (STEL)>

Input Range: Between the time-weighted average (TWA) and the upper limit tolerance (C) in the range of [0.001-10.000] mg/m³

If the latest moving average concentration (mg/m³) for 15 minutes exceeds this setting value, an alarm will be activated.

The short term exposure limit (STEL) is displayed in real time.

The alarm will also be activated if the concentration exceeds the time-weighted average (TWA) 5 times or more within 8 hours or the concentration exceeds TWA twice or more within 60 minutes.

If the measurement time is less than 8 hours, the time length till the end of the measurement is subject to this measurement.

<Upper limit tolerance (C)>

Input Range: The short-term exposure limit (STEL) or less in [0.001-10.000]mg/m³

If the instantaneous concentration (one sampling) (mg/m³) exceeds this set value, an alarm will be indicated.

The upper limit tolerance (C) is displayed in real time.

<Alarm Classification>

The alarm sound will be different depending on the content of an alarm.

The alarm in the TWA measurement mode will be indicated on the measurement screen and beep will sound.

Please note that it will not output to the external output terminal.

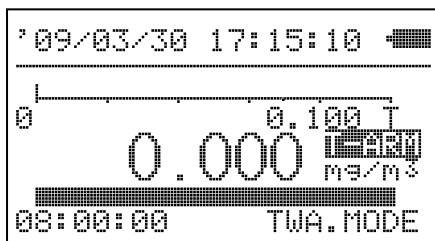

Time-weighted average (TWA) alarm

Short beeps

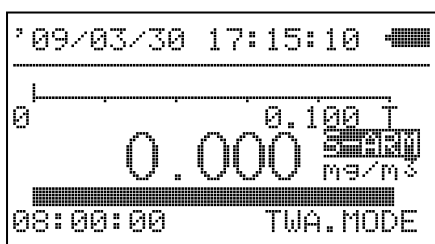

Short-term exposure limit (STEL) alarm

Long beeps

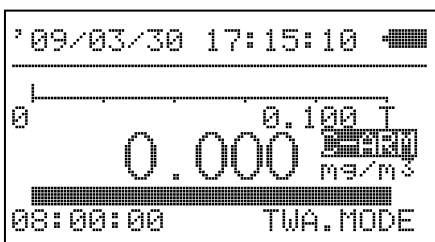

Upper limit tolerance (C) alarm

Continuous beep

* Upper limit tolerance alarm is given the highest priority followed by short-term exposure limit (STEL) alarm and then time-weighted average (TWA) alarm.

For example, if the upper limit tolerance (C) alarm occurs during the Short-term exposure limit (STEL) alarm, the upper limit tolerance (C) alarm will be prioritized.

<Clear Alarm>

When alarm occurs, press [▲] or [▼] key to clear alarm.

If another alarm condition is detected right after an alarm is cleared, alarm will output.

An alarm can only be cleared individually.

If you do not clear an alarm during a measurement, the alarm will keep outputting until you clear an alarm.

An alarm can only be cleared by the user clearing an alarm or starting a next measurement.

3.4.7 USB Communication Connector

By connecting the provided USB cable, you can communicate with a computer.

- (1) Use the provided USB communication cable.
- (2) Install the provided measurement software in your computer.
- (3) For details on the measurement software including the installation procedure, please refer to the operation manual for Measurement Software for Light Scattering Digital Dust Monitor (Model S344-20).

3.5 Measurement Procedure

To perform an accurate measurement, make sure that the instrument is acclimatized to the ambient temperature before use. (Leave the instrument in the measurement environment at least for 20 minutes.)

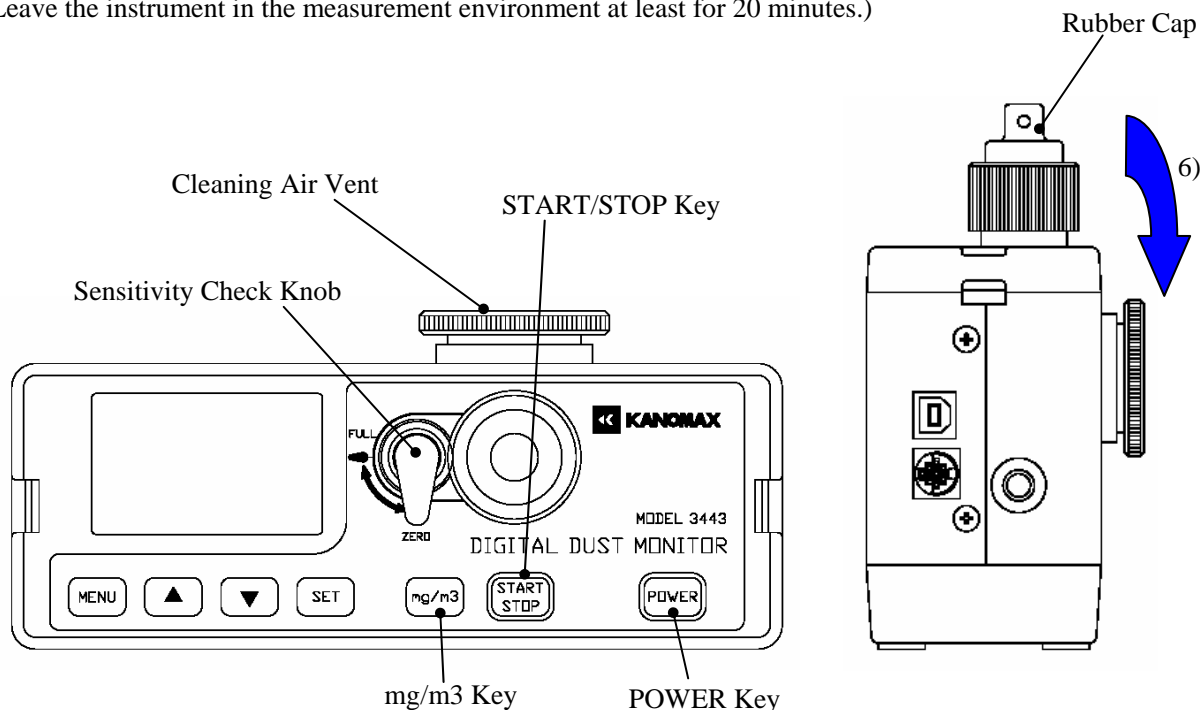

- 1) Press and hold [POWER] key for one second or longer to turn the power on. After warming up for 10 seconds, the instrument is ready to run.
- 2) Start calibration. (Refer to [2.4 Calibration](#).)
- 3) Set K factor. (Refer to [\(c\) K Factor](#) in [3.4.6 Utility](#).)
- 4) Set measurement time. (Refer to [3.4.1 Measurement Mode](#).)
- 5) Check the measurement time at the lower left of the display and the selected measurement mode.
- 6) Put the rubber cap on the cleaning air vent.
Confirm that the sensitivity check knob is at the ZERO side.
- 7) Press [START/STOP] key to start a measurement. Measurement finishes automatically when it reaches the end of the measurement time. You can also stop measuring before it completes by pressing [START/STOP] key.
If the measurement mode is set to MANUAL, press [START/STOP] key to finish measuring.
The measurement result is obtained based on the actual measurement time.
- 8) After a measurement, press [mg/m3] key to display the mass concentration to take the reading. To perform the next measurement, press [START/STOP] key again and repeat the instruction described above.
- 9) After all measurements are done, put the rubber cap on the inlet.
- 10) Perform cleaning. (Refer to [2.3 Cleaning](#).)
- 11) Press and hold [POWER] key for 2 sec or longer to turn the power off.

4. Consumables Replacement

4.1 Filter Replacement

Please replace the filter following the procedure below when error occurs even if you perform calibration several time, you can see the filter is damaged or the filter is very dirty.

<Preparing for replacement part>

Prepare the provided filter for replacement or purchase the filter (3431-03).

<Replacing filter>

- (1) Turn the filter fixing ring on the cleaning air port to the direction shown in the picture below and remove it.
- (2) Remove the rubber packing and filter in the filter holder by using tweezers.
- (3) Prepare the filter for replacement. Then put it all the way in the holder being careful not to damage the filter.
Next set the filter on the rubber packing.

Finally tighten the filter fixing ring on.

* If you forget to place the rubber packing or fail to tighten the lid fully, leaking may occur which will prevent an accurate measurement. Therefore, when replacing parts, be sure not to lose anything.

- (4) After replacing the filter, start performing cleaning. (Refer to [2.3 Cleaning](#))

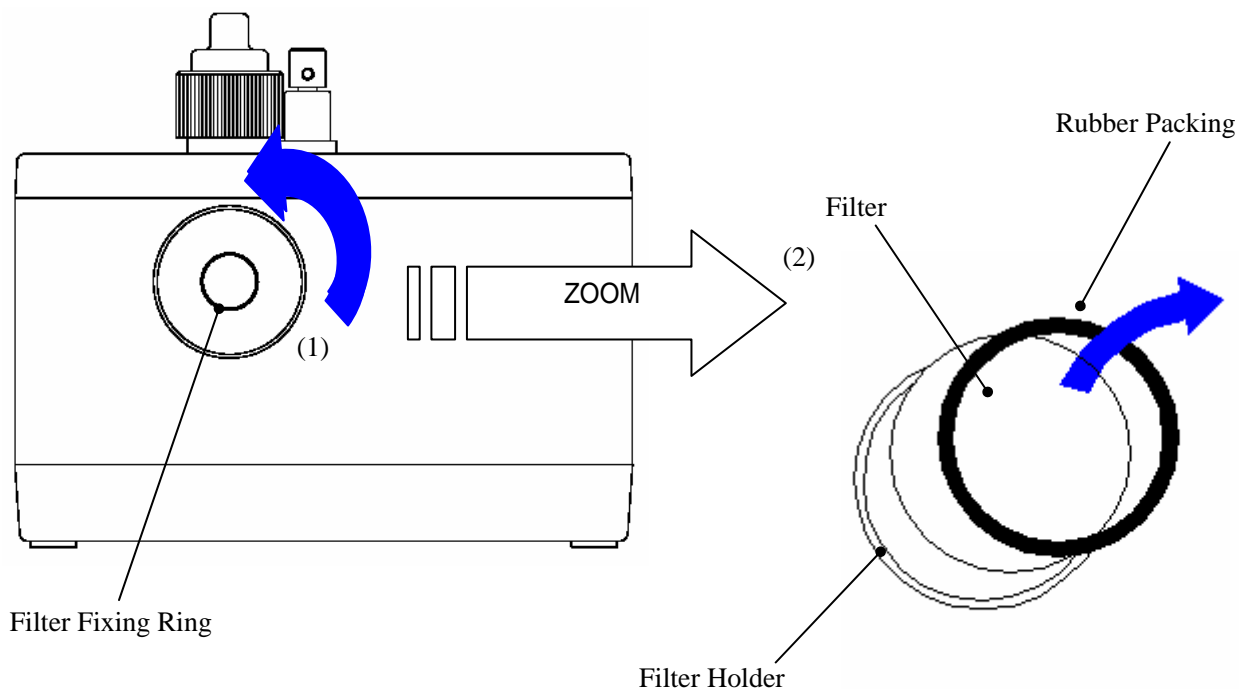

4.2 Protective LCD Sheet Replacement

When the protective LCD sheet becomes dirty or is damaged, replace it.

<Preparing for replacement part>

Prepare the provided protective LCD sheet for replacement or purchase the provided protective LCD sheet (3442-04).

<Replacing protective LCD sheet>

- (1) Remove the protective sheet that is to be replaced.
- (2) Wipe out the dirt and dust on and around the LCD.
- (3) Put the new protective sheet for replacement on the LCD.

4.3. Rubber Protector Replacement

When the rubber protector becomes dirty or is damaged, you can replace the rubber protector.

<Preparing for replacement part>

Purchase the rubber protector (3442-02).

<Replacing rubber protector>

- (1) Remove the AC adapter and output cable.
- (2) Pull the instrument up to remove it from the rubber protector.
- (3) Insert the instrument into the new rubber protector. For the insertion direction, refer to the picture below.
Make sure that the top corners of the rubber protector are fit with the instrument.

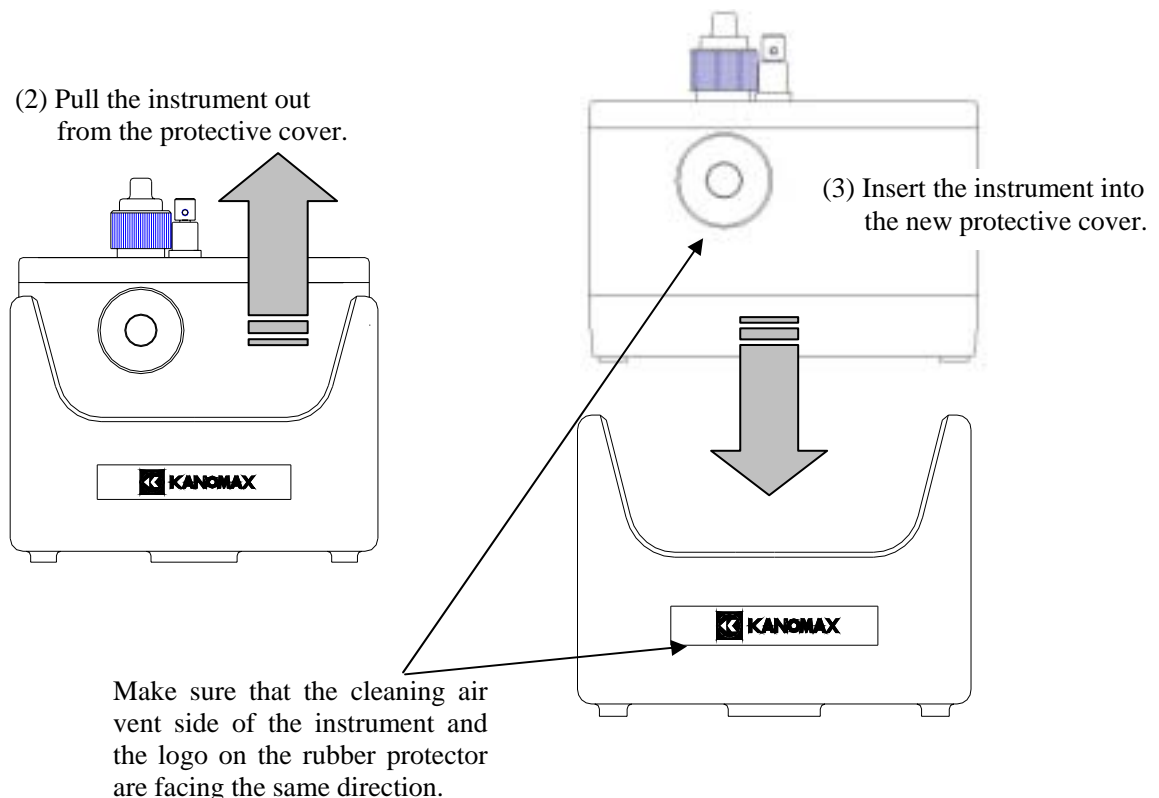

5. Main Specification

Product Name	Light Scattering Digital Dust Monitor
Model Name	MODEL 3443
Measurement Range	0.001 ~ 10.000 mg/m ³ (1 CPM = 0.001 mg/m ³ when using standard particle)
Measurement Accuracy	±(10% of reading + 1) count
Linearity	±5% of reading
Measurement Mode	<ol style="list-style-type: none"> (1) Standard Mode (6, 10, 30 seconds, 1, 2, 3, 5, 10 minutes, TWA) (2) Free Setting Mode (Settable range is 1 ~ 59 sec or 1 ~ 99 min) (3) Manual Mode (Start and stop a measurement manually.) (4) Calculation Mode (The user can repeat measurements based on the settings of measurement start/stop time and the number of measurements. The measurement data can be saved in the built-in memory.) (5) Calibration (background and standard count value) (6) Cleaning
Light Source	Semiconductor Laser Diode
Detector System	Photodiode
Measuring Method	Light Scattering
Display	Graphic LCD (128×64 dot) with backlight
Displayed Items	<ol style="list-style-type: none"> (1) Remaining Battery Level (10 levels) (2) Measurement Time (Remaining Measurement Time) (3) Measurement Value (4) Measurement Mode (5) K Factor (6) Graph
Output Terminal	<p>Analog Output (The output range setting can be switched over.)</p> <ul style="list-style-type: none"> - 0 – 1 mg/m³ range: 0-1V - 0 – 10 mg/m³ range: 0-1V - AUTO mg/m³ range: 0 – 1 mg/m³ range: 0-1V <li style="padding-left: 2em;">1 – 10 mg/m³ range: 0.1-1V - 0 – 1,000 CPM range: 0-1 V - 0 – 10,000 CPM range: 0-1 V - AUTO CPM range: 0 – 1,000 CPM range: 0-1 V <li style="padding-left: 2em;">1,000 – 10,000 CPM: 0.1 – 1 V <p>Pulse Output (Photo-coupler Contact Output)</p> <p>Alarm Output (Photo-coupler Contact Output)</p>
Communication	USB Port <ul style="list-style-type: none"> - Data Transfer - Parameter Setting - Remote Setting
Calibration Function	Auto Background
Factor of Mass Concentration Conversion Coefficient	Settable on operation panel (Settable range: 0.0001 ~ 0.0099, in increments of 0.0001)
Data log & Calculation Function	Up to 100,000 data points can be saved. Data Readout, Data Display Calculation Function

Power	AA batteries (1.5 × 6 pcs) AC: AC adapter (Input 100-240 V) The product does not have charging function.		
Battery Operating Time	Continuous operation time: 12 hours (when alkaline batteries are used.)		
Usage Environment	Temperature: 5 ~ 40 °C Humidity: 95 %RH or lower (Non condensing)		
Storage Environment	Temperature 0 ~ 45 °C Humidity: 95 %RH or lower (Non condensing)		
Dimensions	162 × 60 × 102 mm (excluding projections)		
Weight	Approximately 1.1 kg (excluding batteries)		
Accessories	AC Adapter		1 pc
	Filter		2 pc
	Shoulder Strap		1 pc
	Operation Manual (Main Unit)		1 pc
	Manganese Batteries		6 pc
	Measurement Software (CD)		1 pc
	Communication Cable		1 pc
	LCD Protective Sheet		1 pc
	Rubber Cap		1 pc
	Rubber Cap String		1 pc
	Rubber Protector		1 pc
Optional Extras, Consumables Sold Separately	Output Cable	(3442-01)	For analog, pulse & alarm output
	Rubber Cap	(3431-02)	1 pc
	Filter	(3431-03)	1 set (10 pc)
	LCD Protective Sheet	(3442-04)	1 set (2 pc)
	Carrying Case	(3442-05)	1 pc
	AC Adapter	(6113-02)	1 pc
	Rubber Protector	(3443-02)	1 pc

6. Troubleshooting

6.1 Check Power

Symptom	Possible Cause / Solution	Refer to
Even when the power switch is turned ON, on-screen display does not appear or display goes off quickly.	- When using battery: The battery is exhausted. => Turn the power off and charge the battery.	4
	- When using AC adapter: The dedicated adapter is not being used. => Make sure to use the dedicated AC adapter.	5
Even after replacing batteries with new ones, the screen does not show up.	- The polarity of the batteries may be reversed. => Check if the batteries are inserted properly.	4
Batteries die very quickly.	Different type of batteries may be used. Exhausted batteries and new batteries may be mixed.	4
When using NiMH batteries, the batteries die very quickly.	The batteries may not have been charged fully. => Charge the batteries fully referring to the operation manual supplied with the NiMH batteries.	4
	The NiMH batteries may be deteriorated. => Purchase new NiMH batteries.	4

6.2 Check while Measuring

Symptom	Possible Cause / Solution	Refer to
Count value remains 0.	Rubber cap may be put on the inlet. Remove the rubber cap and then insert the removed rubber cap to the cleaning air vent to perform a measurement.	2
	The exhaust port may be blocked. Remove the things that block the exhaust port.	2
Count value is too low.	The rubber cap may not be inserted to the cleaning air vent. Insert the rubber cap properly before starting a measurement.	2
	Compare the count value upon checking the sensitivity to the standard count value. If the count value upon checking the sensitivity is more than 5% lower than the standard value, calibrate the unit to check the sensitivity.	8
Count value is too high.	The sensitivity check knob may still be at "FULL" side. Turn the knob fully to the "ZERO" side.	2
	Compare the count value upon checking the sensitivity to the standard count value. If the count value upon checking the sensitivity is more than 5% higher than the standard value, calibrate the unit to check the sensitivity.	8

6.3 Zero Check

Symptom	Possible Cause / Solution	Refer to
Zero is not stable	Rubber cap may not be put on the inlet or may not be inserted properly. Put the rubber cap on properly.	2
	Filter may be clogged. Replace the filter with a new one.	35
	Inside the optical system may be dirty. Relatively light particles such as carbon or resin could enter inside the optical system, which could result in Zero point rise. Perform a cleaning well (for at least 10 minutes). If it does not become stable even after cleaning, the instrument needs to be disassembled for further cleaning. Please contact your distributor or KANOMAX service center.	7
	The instrument may not be used under the specified usage environment. Operating temperature limit is 5 ~ 40 °C and humidity limit is 95 %RH or lower.	36
Zero adjustment cannot be performed.	The sensitivity check knob may not be at the “ZERO” side. Put it back to “ZERO” side.	2
	The instrument may not be used under the specified usage environment. Operating temperature limit is 5 ~ 40 °C and humidity limit is 95 %RH or lower.	36

6.4 Sensitivity Check

Symptom	Possible Cause / Solution	Refer to
The value is lower than the standard count value. The reproducibility is not good.	The sensitivity check knob may not be at the “FULL” side. Put it back to “FULL” side.	2
	The instrument may not be used under the specified usage environment. Operating temperature limit is 5 ~ 40 °C and humidity limit is 95 %RH or lower.	36
Sensitivity cannot be adjusted.	The instrument may not be used under the specified usage environment. Operating temperature limit is 5 ~ 40 °C and humidity limit is 95 %RH or lower.	36
	The sensitivity may be beyond the specified sensitivity adjustment range or the light source may be deteriorated. Please contact your distributor or KANOMAX service center.	8

6.5 Calibration Check

Symptom	Possible Cause / Solution	Refer to
ZERO cannot be adjusted. (BACK GROUND)	The zero adjustment range may exceed the specified range. If the ZERO adjustment range exceeds the standard range ± 20 counts before shipping, it is a calibration error. Please contact your distributor or KANOMAX service center for repair.	8
Sensitivity cannot be adjusted. (SPAN CALIBRATION)	The sensitivity may be beyond the specified sensitivity adjustment range. When the sensitivity adjustment range is beyond the range before shipping by $\pm 20\%$, it is considered as calibration error. Please contact your distributor or KANOMAX service center for repair.	8
	The scattering plate or light source may be deteriorated. Please contact your distributor or KANOMAX service center for repair.	-

6.6 Analog Output

Symptom	Possible Cause / Solution	Refer to
There is no output.	The plug may not be firmly inserted into the output terminal. The dedicated output cable must be used.	28
Output value is wrong.	The output cable may not be inserted properly.	28
	The load impedance may be set lower than the specified value. (Load impedance: 1 k Ω or higher)	
Output value exceeds the specified value.	The instantaneous value may exceed the concentration equivalent to 10,000 CPM of the instantaneous value.	28
The response is slow.	The output is updated every 1 second.	28
The display and the output voltage do not match.	The output range may not be set properly. <ul style="list-style-type: none"> · 0 – 1 mg/m³ range: 0-1V · 0 – 10 mg/m³ range: 0-1V · AUTO mg/m³ range: 0 – 1 mg/m³ range: 0-1V 1 – 10 mg/m³ range: 0.1-1V · 0 – 1,000 CPM range: 0-1 V · 0 – 10,000 CPM range: 0-1 V · AUTO CPM range: 0 – 1,000 CPM range: 0-1 V 1,000 – 10,000 CPM: 0.1 – 1 V 	28
		The CPM of analog output is instantaneous value. It differs from the counts (integrated value) on the LCD.

6.7 Pulse Output

Symptom	Possible Cause / Solution	Refer to
There is no output.	The plug may not be firmly inserted into the output terminal. The dedicated output cable must be used.	31
The output signal level is wrong.	The instrument may not be used within the rating (voltage and current).	31
	The polarity may be wrong (+, -).	
Output value exceeds the specified value.	The instantaneous value may exceed the concentration equivalent to 10,000 CPM of the instantaneous value.	31

6.8 Alarm Output

Symptom	Possible Cause / Solution	Refer to
There is no output or the timing of the output is uncertain.	The plug may not be firmly inserted into the output terminal. The dedicated output cable may not be used. The alarm setting value may not be set properly. · mg/m ³ range: 0-10,000mg/m ³ · CPM range: 0-10,000CPM The alarm setting may not be ON.	28
	The alarm is output only during a measurement.	28
The output signal level is wrong.	The instrument may not be used within the rating (voltage and current).	28
	The polarity may be wrong (+, -).	
The alarm is left to be output.	The instantaneous value may exceed the concentration equivalent to 10,000 CPM of the instantaneous value.	28

6.9 Calendar Setting

Symptom	Possible Cause / Solution	Refer to
Date and time are lagging dramatically, or after setting the date and time, they both reset.	The backup battery may start becoming weak. We recommend replacing the backup battery. Please contact your sales representative or KANOMAX service center. * The backup battery life is about 10 years. This is just an indication because the battery life differs depending on the operation frequency or usage environment. Since a primary battery is used for the backup battery, it cannot be charged when the instrument is turned on.	24

7. Warranty and After-sales Service

KANOMAX Limited Warranty

The limited warranty set below is given by KANOMAX with respect to the KANOMAX brand Light Scattering Digital Dust Monitor and other accessories (hereafter referred to as “PRODUCT”) that you have purchased. PRODUCT you have purchased shall be the only one that the limited warranty stated herein applies to.

Your PRODUCT, when delivered to you in new condition in its original container, is warranted against defects in materials or workmanship as follows: for a period of one (1) year from the date of original purchase, defective parts or a defective PRODUCT returned to your sales representative, as applicable, and proven to be defective upon inspection, will be exchanged for a new or comparable rebuilt parts, or a refurbished PRODUCT as determined by your sales representative. Warranty for such replacements shall not extend the original warranty period of the defective PRODUCT.

This limited warranty covers all defects encountered in normal use of the PRODUCT, and does not apply to the following cases:

- (1) Use of parts or supplies other than the PRODUCT sold by your sales representative, which cause damage to the PRODUCT or cause abnormally frequent service calls or service problems.
- (2) If any PRODUCT has its serial number or date altered or removed.
- (3) Damage to the PRODUCT due to abuse, mishandling, improper packaging by the owner, alteration, accident, electrical current fluctuations, failure to follow operating, maintenance or environmental instructions prescribed in the PRODUCT's instruction manual provided by KANOMAX, or service performed by other than KANOMAX.

NO IMPLIED WARRANTY, INCLUDING ANY IMPLIED WARRANTY OF MERCHANTABILITY OR FITNESS FOR A PARTICULAR PURPOSE, APPLIES TO THE PRODUCT AFTER THE APPLICABLE PERIOD OF THE EXPRESS LIMITED WARRANTY STATED ABOVE, AND NO OTHER EXPRESS WARRANTY OR GUARANTY, EXCEPT AS MENTIONED ABOVE, GIVEN BY ANY PERSON OR ENTITY WITH RESPECT TO THE PRODUCT SHALL BIND KANOMAX. KANOMAX SHALL NOT BE LIABLE FOR LOSS OF STORAGE CHARGES, LOSS OR CORRUPTION OF DATA, OR ANY OTHER SPECIAL, INCIDENTAL OR CONSEQUENTIAL DAMAGES CAUSED BY THE USE OR MISUSE OF, OR INABILITY TO USE, THE PRODUCT, REGARDLESS OF THE LEGAL THEORY ON WHICH THE CLAIM IS BASED, AND EVEN IF KANOMAX HAS BEEN ADVISED OF THE POSSIBILITY OF SUCH DAMAGES. IN NO EVENT SHALL RECOVERY OF ANY KIND AGAINST KANOMAX BE GREATER IN AMOUNT THAN THE PURCHASE PRICE OF THE PRODUCT SOLD BY KANOMAX AND CAUSING THE ALLEGED DAMAGE. WITHOUT LIMITING THE FOREGOING, THE OWNER ASSUMES ALL RISK AND LIABILITY FOR LOSS, DAMAGE OF, OR INJURY TO THE OWNER AND THE OWNER'S PROPERTY AND TO OTHERS AND THEIR PROPERTY ARISING OUT OF USE OR MISUSE OF, OR INABILITY TO USE, THE PRODUCT NOT CAUSED DIRECTLY BY THE NEGLIGENCE OF KANOMAX. THIS LIMITED WARRANTY SHALL NOT EXTEND TO ANYONE OTHER THAN THE ORIGINAL PURCHASER OF THE PRODUCT, OR THE PERSON FOR WHOM IT WAS PURCHASED AS A GIFT, AND STATES THE PURCHASER'S EXCLUSIVE REMEDY.

After-sales Service

If the PRODUCT is malfunctioning, please check with “Troubleshooting” to find possible cause first.

Repair parts are retained for a minimum period of five (5) years after production cessation of the PRODUCT. This storage period of repair parts is considered as the period during which KANOMAX can provide repair service.

For more information, please contact your sales representative. When you make a call, please have the following information of your PRODUCT at hand.

- (1) PRODUCT name
- (2) Model number
- (3) Serial number
- (4) Description of Symptom
- (5) Date of purchase

8. Contact Information



U.S.A.

KANOMAX USA, INC.

219 US Hwy. 206, PO Box 372, Andover, NJ 07821 U.S.A.

Tel: (800)-247-8887 / (973)-786-6386 **FAX:** (973)-786-7586

URL: <http://www.kanomax-usa.com/>

E-Mail: info@kanomax-usa.com

JAPAN

KANOMAX JAPAN, INC.

2-1 Shimizu Suita City, Osaka 565-0805, Japan

TEL: 81-6-6877-0183 **FAX:** 81-6-6877-5570

URL: <http://www.kanomax.co.jp/>

E-Mail: sales@kanomax.co.jp

CHINA

Shenyang Kano Scientific Instrument Co., Ltd

2610, 51 Wulihe Street, Heping District

Shenyang City PRC

TEL: 86-24-23845309 **FAX:** 86-24-23898417

URL: <http://www.kanomax.com.cn/>

E-mail: sales@kanomax.com.cn



KANOMAX

Contact:
Industrial Process Measurement, Inc.
3910 Park Avenue, Unit 7
Edison, NJ 08820
732-632-6400
support@instrumentation2000.com
<http://www.instrumentation2000.com>