

Multi-Range DC Power Supply

PFR-100 Series

USER MANUAL



ISO-9001 CERTIFIED MANUFACTURER

GW INSTEK

This manual contains proprietary information, which is protected by copyright. All rights are reserved. No part of this manual may be photocopied, reproduced or translated to another language without prior written consent of Good Will company.

The information in this manual was correct at the time of printing. However, Good Will continues to improve products and reserves the rights to change specification, equipment, and maintenance procedures at any time without notice.

Good Will Instrument Co., Ltd.
No. 7-1, Jhongsing Rd., Tucheng Dist., New Taipei City 236, Taiwan.

Table of Contents

SAFETY INSTRUCTIONS	5
GETTING STARTED.....	9
PFR-100 Series Overview.....	10
Appearance.....	13
Theory of Operation.....	20
OPERATION	32
Set Up.....	33
Basic Operation	44
Test Scripts	58
CONFIGURATION.....	66
Configuration Overview	67
ANALOG CONTROL.....	83
Analog Remote Control Overview.....	84
Remote Monitoring.....	102
COMMUNICATION INTERFACE	107
Interface Configuration.....	108
FAQ.....	134
APPENDIX.....	136
PFR-100 Factory Default Settings	136
Error Messages & Messages	138
LED ASCII Table Character Set.....	139
PFR-100 Specifications.....	140
PFR-100 Dimensions.....	146
Declaration of Conformity.....	147

INDEX..... 148

S SAFETY INSTRUCTIONS

This chapter contains important safety instructions that you must follow during operation and storage. Read the following before any operation to insure your safety and to keep the instrument in the best possible condition.

Safety Symbols

These safety symbols may appear in this manual or on the instrument.



WARNING

Warning: Identifies conditions or practices that could result in injury or loss of life.



CAUTION

Caution: Identifies conditions or practices that could result in damage to the PFR-100 or to other properties.



DANGER High Voltage



Attention Refer to the Manual



Protective Conductor Terminal



Earth (ground) Terminal



Do not dispose electronic equipment as unsorted municipal waste. Please use a separate collection facility or contact the supplier from which this instrument was purchased.

Safety Guidelines

General Guideline



CAUTION

- Do not place any heavy object on the PFR-100.
- Avoid severe impact or rough handling that leads to damaging the PFR-100.
- Do not discharge static electricity to the PFR-100.
- Use only mating connectors, not bare wires, for the terminals.
- Do not disassemble the PFR-100 unless you are qualified.

Power Supply



WARNING

- AC Input Voltage: 100Vac-240Vac
- Frequency: 47Hz to 63Hz
- To avoid electrical shock connect the protective grounding conductor of the AC power cord to an earth ground.

Cleaning the PFR-100

- Disconnect the power cord before cleaning.
- Use a soft cloth dampened in a solution of mild detergent and water. Do not spray any liquid.
- Do not use chemicals containing harsh material such as benzene, toluene, xylene, and acetone.

Operation Environment

- Location: Indoor, no direct sunlight, dust free, almost non-conductive pollution (Note below)
- Relative Humidity: 20%~ 80% (no condensation)
- Altitude: < 2000m
- Temperature: 0°C to 40°C

(Pollution Degree) EN61010-1:2010 specifies the pollution degrees and their requirements as follows. The PFR-100 falls under degree 2.

Pollution refers to “addition of foreign matter, solid, liquid, or gaseous (ionized gases), that may produce a reduction of dielectric strength or surface resistivity”.

- Pollution degree 1: No pollution or only dry, non-conductive pollution occurs. The pollution has no influence.
- Pollution degree 2: Normally only non-conductive pollution occurs. Occasionally, however, a temporary conductivity caused by condensation must be expected.
- Pollution degree 3: Conductive pollution occurs, or dry, non-conductive pollution occurs which becomes conductive due to condensation which is expected. In such conditions, equipment is normally protected against exposure to direct sunlight, precipitation, and full wind pressure, but neither temperature nor humidity is controlled.

Storage environment

- Location: Indoor
- Temperature: -20°C to 70°C
- Relative Humidity: 20 to 85% (no condensation)

Disposal



Do not dispose this instrument as unsorted municipal waste. Please use a separate collection facility or contact the supplier from which this instrument was purchased. Please make sure discarded electrical waste is properly recycled to reduce environmental impact.

Power cord for the United Kingdom

When using the power supply in the United Kingdom, make sure the power cord meets the following safety instructions.

NOTE: This lead/appliance must only be wired by competent persons



WARNING: THIS APPLIANCE MUST BE EARTHED

IMPORTANT: The wires in this lead are coloured in accordance with the following code:

Green/ Yellow:	Earth
Blue:	Neutral
Brown:	Live (Phase)



As the colours of the wires in main leads may not correspond with the coloured marking identified in your plug/appliance, proceed as follows:

The wire which is coloured Green & Yellow must be connected to the Earth terminal marked with either the letter E, the earth symbol \oplus or coloured Green/Green & Yellow.

The wire which is coloured Blue must be connected to the terminal which is marked with the letter N or coloured Blue or Black.

The wire which is coloured Brown must be connected to the terminal marked with the letter L or P or coloured Brown or Red.

If in doubt, consult the instructions provided with the equipment or contact the supplier.

This cable/appliance should be protected by a suitably rated and approved HBC mains fuse: refer to the rating information on the equipment and/or user instructions for details. As a guide, a cable of 0.75mm² should be protected by a 3A or 5A fuse. Larger conductors would normally require 13A types, depending on the connection method used.

Any exposed wiring from a cable, plug or connection that is engaged in a live socket is extremely hazardous. If a cable or plug is deemed hazardous, turn off the mains power and remove the cable, any fuses and fuse assemblies. All hazardous wiring must be immediately destroyed and replaced in accordance to the above standard.

G E T T I N G S T A R T E D

This chapter describes the power supply in a nutshell, including its main features and front / rear panel introduction. After going through the overview, please read the theory of operation to become familiar with the operating modes, protection modes and other safety considerations.



PFR-100 Series Overview	10
Series lineup	10
Main Features.....	10
Accessories	11
Appearance.....	13
Front Panel.....	13
Display Area.....	16
Rear Panel.....	18
Theory of Operation	20
Operating Area Description	20
CC and CV Mode.....	22
Slew Rate	23
Bleeder Control	24
Sink Current Table	25
Alarms.....	26
Considerations	27
Grounding.....	30

PFR-100 Series Overview

Series lineup

The PFR-100 series consists of 2 models, covering a number of different current, voltage and power capacities:

Model name	Operation Voltage	Operation Current	Rated Power
PFR-100L	0-50V	0-10A	100W
PFR-100M	0-250V	0-2A	100W

Main Features

- Performance
- Variable voltage and current combinations with 5 times of coverage ratio of its range within the rated power.
 - Constant voltage/constant current with automatic crossover.
 - Active Power Factor correction.
 - Universal Input Voltage 85 - 265Vac, continuous operation.
 - Natural convection cooling.
-

- Features
- Preset memory function.
 - Output ON/OFF delay function.
 - CV, CC priority start function. (prevents overshoot with output ON)
 - Adjustable voltage and current slew rates.
 - Bleeder circuit ON/OFF setting. (to prevent over-discharging of batteries)
 - OVP, OCP, AC FAIL, OPP and OTP protection.
 - Supports test scripts.
-

- Web server monitoring and control. (The function is activated when connecting to LAN Interface)
- Analog monitor output.
- Remote sensing to compensate for voltage drop in load leads.
- Built-in front panel and rear panel output terminal.

Interface

- Built-in USB and RS-232/485 interface.
- External analog control function.
- Optional LAN and GPIB interface.

Accessories

Before using the PFR-100 power supply unit, check the package contents to make sure all the standard accessories are included.

Standard Accessories	Part number	Description	Qty.
	CD-ROM	User manual, Programming manual	1
		Power Cord	1
	GTL-134	Test leads for rear panel, 1.2m, 10A, 16AWG	1
	PFR-001	Binding Posts Terminal Accessory Kit (Output terminal cover × 1, Output terminal × 1, Socket × 1, Protection Cover × 2, Short Bar × 1)	1
	GTL-104A	Test leads for PFR-100L (Binding Posts Terminal), 1m, 10A	1
	PFR-002	European Type Jack Terminal Accessory Kit (Output terminal cover × 1, Output terminal × 1, Socket × 1, Protection Cover × 2, Short Wire × 1)	1
	GTL-105A	Test leads for PFR-100M, 1m, 3A	1

GTL-204A	Test leads for PFR-100L (European Type Jack Terminal), 1m, 10A	1
----------	--	---

Optional Accessories

Part number	Description
GRA-431-J-100	Rack mount adapter (JIS) with AC 100V
GRA-431-J-200	Rack mount adapter (JIS) with AC 200V
GRA-431-E-100	Rack mount adapter (EIA) with AC 100V
GRA-431-E-200	Rack mount adapter (EIA) with AC 200V
GTL-258	GPIB Cable, 2000mm
PSU-232	RS-232 Cable with DB9 Connector Kit. It includes RS-232 cable with DB9 connector, RS-485 used master cable (gray plug), slave cable (black plug) and end plug terminal.
PSU-485	RS-485 Cable with DB9 Connector Kit. It includes RS-485 cable with DB9 connector, RS-485 used master cable (gray plug), slave cable (black plug) and end plug terminal.
GTL-246	USB Cable (USB 2.0 Type A- Type B Cable, 4P)

Factory Installed Options



Part number	Description
PFR-GL	LAN + GPIB interface

Appearance

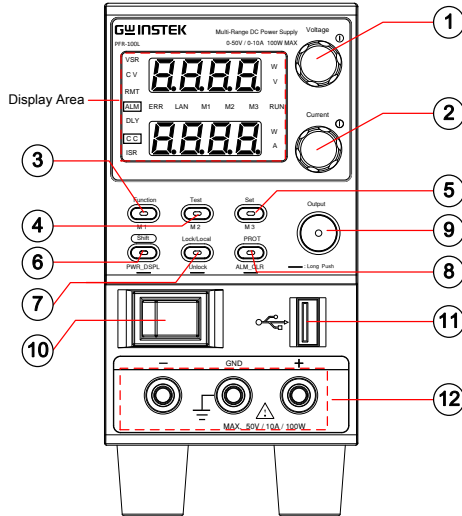



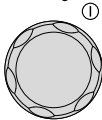
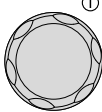

Front Panel





Display Area The display area shows setting values, output values and parameter settings. The function LEDs below show the current status and mode of the power supply. See page 16 for details.



- 1. **Voltage Knob**  Used to set the voltage value or select a parameter number in the Function settings.
- 2. **Current Knob**  Used to set the current value or change the value of a Function parameter.
- 3. **Function Button**  Used to configure the various functions.

M1

- | | | |
|----------------------|---|--|
| M1 Button | | (+Shift) Used to recall the M1 setup.
(+Shift and hold) Used to save the current setup to M1. |
| 4. Test Button | <p>TEST</p>  <p>M2</p> | Used to run customized scripts for testing. |
| M2 Button | | (+Shift) Used to recall the M2 setup.
(+Shift and hold) Used to save the current setup to M2. |
| 5. Set Button | <p>SET</p>  <p>M3</p> | Used to set and confirm the output voltage and output current. |
| M3 Button | | (+Shift) Used to recall the M3 setup.
(+Shift and hold) Used to save the current setup to M3. |
| 6. Shift Button |   <p>PWR_DSPL</p> | Used to enable the functions that are written in blue characters below certain buttons. |
| PWR_DSPL | | (Long push) Displays the output power on the voltage meter or current meter. Press the Voltage knob for V/W, Press the Current knob for A/W. |
| 7. Lock/Local Button | <p>Lock/Local</p>  | Used to lock all front panel buttons other than the Output Button or it switches to local mode. |
| Unlock Button | <p>Unlock</p>  | (Long push) Used to unlock the front panel buttons. |

- 8. PROT Button  Used to set and display OVP, OCP and UVL.

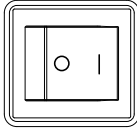
ALM_CLR 

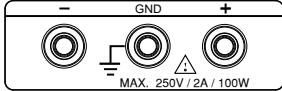
ALM_CLR Button (Long push) Used to release protection functions that have been activated.
- 9. Output Button  Used to turn the output on or off.
- 10. Power Switch  Used to turn the power on/off.
- 11. USB A Port  USB A port for data transfer, loading test scripts etc.
- 12. Output terminal  DC output terminal for PFR-100M is European Type Jack Terminal.
The max. output is 250V/2A/100W

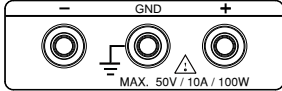
 DC output terminal for PFR-100L is Binding Posts Terminal or European Type Jack Terminal.
The max. output is 50V/10A/100W

Display Area

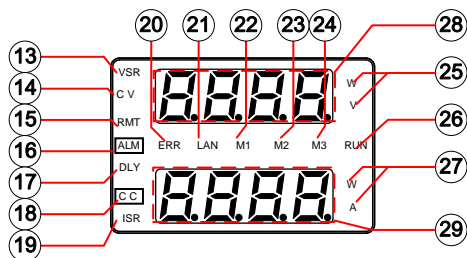

- | | |
|-------------|--|
| 13. VSR LED | Lights up when CV Slew Rate Priority is enabled. |
| 14. CV LED | Lights in green during constant voltage mode. |
| 15. RMT LED | Lights in green during remote control. |
| 16. ALM LED | Lights in red when a protection function has been activated. |
| 17. DLY LED | The Output On/Off Delay indicator LED. |
| 18. CC LED | Lights in green during constant current mode. |
| 19. ISR LED | Lights up when CC Slew Rate Priority is enabled. |
| 20. ERR LED | Lights in red when an error has occurred. |
| 21. LAN LED | Lights up when the LAN remote connection is established. |
| 22. M1 LED | Lights in green when the memory value are being recalled or saved. |

- 23. M2 LED Lights in green when the memory value are being recalled or saved.

- 24. M3 LED Lights in green when the memory value are being recalled or saved.

- 25. V or W LED Display Voltage or Watt unit.

- 26. RUN LED Lights up when a Test Script has been activated.

- 27. A or W LED Display Current or Watt unit.

- 28. Voltage Meter Displays the voltage or the parameter number of a Function parameter.

- 29. Current Meter Displays the current or the value of a Function parameter.

Rear Panel

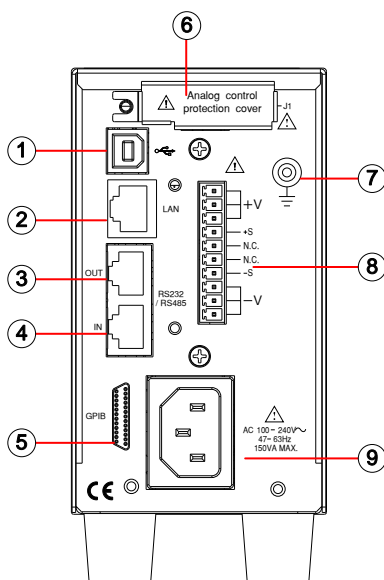

1. **USB** USB port for controlling the PFR-100 remotely.
2. **LAN** Ethernet port for controlling the PFR-100 remotely (Factory Installed Options).
3. **Remote-OUT** RJ-45 connector that is used to daisy chain power supplies with the Remote-IN port to form a communication bus.
4. **Remote-IN** Two different types of cables can be used for RS232 or RS485-based remote control.
 PSU-232: RS232 cable with DB9 connector kit.
 PSU-485: RS485 cable with DB9 connector kit.
5. **GPIB** GPIB connector for units equipped with IEEE programming option. (Factory Installed Options)

6. J1 External analog remote control connector.
7. Ground Screw Connectors for grounding the output.
8. Output Terminals It uses a 10 pin connector and a plug for the output and sense terminal connections.
9. Line Voltage Input AC inlet.

Theory of Operation

The theory of operation chapter describes the basic principles of operation, protection modes and important considerations that must be taken into account before use.

Operating Area Description

Background

The PFR-100 power supplies are regulated DC power supplies with a high voltage and current output. These operate in CC or CV mode within a wide operating range limited only by the voltage or current output.

The operating area of each power supply is determined by the rated output power as well as the voltage and current rating.

For example the operating area and rated power output for the PFR-100L is shown below.

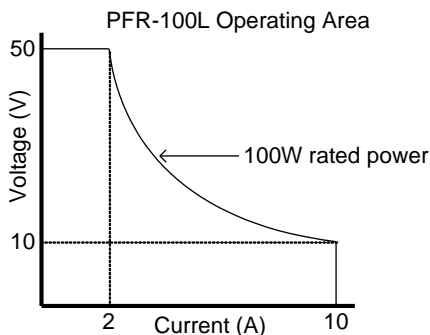

When the power supply is configured so that the total output (current x voltage output) is less than the rated power output, the power supply functions as a typical constant current,

constant voltage power supply.

If however, the power supply is configured such that the total output (current x voltage output) exceeds the rated power output, the effective output is actually limited to the power limit of the unit. In this case the output current and voltage then depend purely on the load value.

Below is a comparison of the operating areas of each power supply.

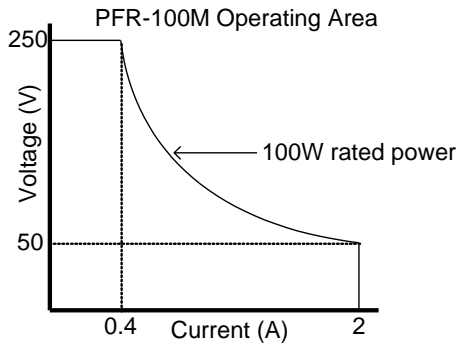
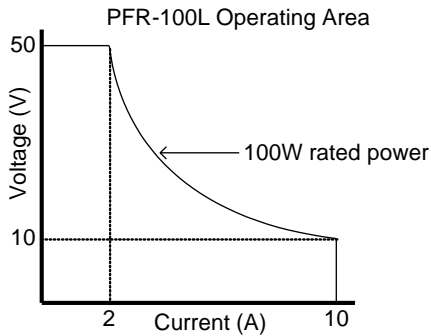

CC and CV Mode

CC and CV mode Description

When the power supply is operating in constant current mode (CC) a constant current will be supplied to the load. When in constant current mode the voltage output can vary, whilst the current remains constant. When the load resistance increases to the point where the set current limit (I_{SET}) can no longer be sustained the power supply switches to CV mode. The point where the power supply switches modes is the crossover point.

When the power supply is operating in CV mode, a constant voltage will be supplied to the load, whilst the current will vary as the load varies. At the point that the load resistance is too low to maintain a constant voltage, the power supply will switch to CC mode and maintain the set current limit.

The conditions that determine whether the power supply operates in CC or CV (V_{SET}), the load resistance (R_L) and the critical resistance (R_C). The critical resistance is determined by V_{SET}/I_{SET} . The power supply will operate in CV mode when the load resistance is greater than the critical resistance. This means that the voltage output will be equal to the V_{SET} voltage but the current will be less than I_{SET} . If the load resistance is reduced to the point that the current output reaches the I_{SET} level, the power supply switches to CC mode.

Conversely the power supply will operate in CC mode when the load resistance is less than the critical resistance. In CC mode the current output is equal to I_{SET} and the voltage output is less than V_{SET} .

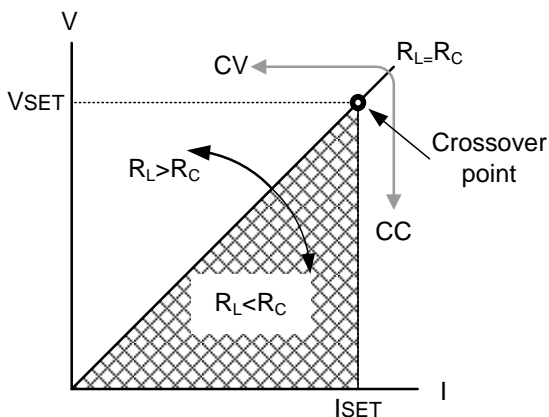

Slew Rate

Theory

The PFR-100 has selectable slew rates for CC and CV mode. This gives the PFR-100 power supply the ability to limit the current/voltage draw of the power supply. Slew rate settings are divided into High Speed Priority and Slew Rate Priority. High speed priority mode will use the fastest slew rate for the instrument. Slew Rate Priority mode allows for user adjustable slew rates for CC or CV mode. The rising and falling slew rate can be set independently.

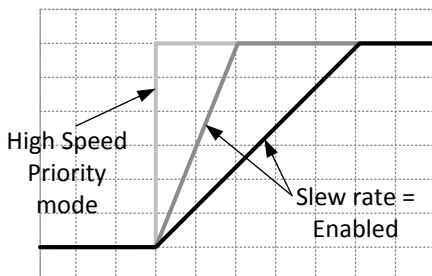

Bleeder Control

Background

The PFR-100 DC power supplies employ a bleed resistor in parallel with the output terminals.

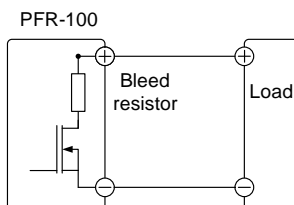

Bleed resistors are designed to dissipate the power from the power supply filter capacitors when power is turned off and the load is disconnected. Without a bleed resistor, power may remain charged on the filter capacitors for some time and be potentially hazardous.

In addition, bleed resistors also allow for smoother voltage regulation of the power supply as the bleed resistor acts as a minimum voltage load.

The bleed resistance can be turned on or off using the configuration settings.



Note

By default the bleed resistance is on. For battery charging applications, be sure to turn the bleed resistance off as the bleed resistor can discharge the connected battery when the unit is off.

Sink Current Table

Background

Sink current (reference value) from an external voltage source according to the bleeder circuit setting.

PFR-100M	Vout	Bleeder ON	Bleeder OFF
		Sink Current	
	(V)	(A)	(mA)
	25	0.135	0.001
	50	0.119	0.007
	75	0.103	0.014
	100	0.087	0.022
	125	0.071	0.032
	150	0.055	0.034
	175	0.039	0.043
	200	0.034	0.051
	225	0.031	0.067
	250	0.028	0.086

PFR-100L

PFR-100L	Vout	Bleeder ON	Bleeder OFF
		Sink Current	
	(V)	(A)	(mA)
	5	0.746	0.006
	10	0.658	0.009
	15	0.570	0.013
	20	0.482	0.017
	25	0.375	0.026
	30	0.310	0.038
	35	0.257	0.038
	40	0.236	0.048
	45	0.218	0.074
	50	0.200	0.200

Alarms

The PFR-100 power supplies have a number of protection features. When one of the protection alarms is set, the ALM icon on the display will be lit. For details on how to set the protection modes, please see page 44.

OVP	Over voltage protection (OVP) prevents a high voltage from damaging the load. This alarm can be set by the user.
OCP	Over current protection prevents high current from damaging the load. This alarm can be set by the user.
OPP	Over power protection prevents abnormally use from damaging the PFR-100. When the output power is over 103W, the alarm signal will be lit and start to counter. After a little time, OPP will be triggered and turn off output.
UVL	Under voltage limit. This function sets a minimum voltage setting level for the output. It can be set by the user.
OHP	Over temperature protection protect the instrument from overheating
AC	AC Fail. This alarm function is activated when a low AC input is detected.
SENSE ALARM1	This alarm function is activated when real output voltage is larger than sense output voltage. $V_{o_real} > V_{o_sense} + 1.5V$ for PFR-100L $V_{o_real} > V_{o_sense} + 2.5V$ for PFR-100M

SENSE ALARM2	This alarm function is activated when sense output voltage is larger than real output voltage. $V_{o_sense} > V_{o_real} + 1V$
Shutdown	Force Shutdown is not activated as a result of the PFR-100 series detecting an error. It is a function that is used to turn the output off through the application of a signal from the rear-panel analog control connector when an abnormal condition occurs.
Alarm output	Alarms are output via the analog control connector. The alarm output is an isolated open-collector photo coupler output.

Considerations

The following situations should be taken into consideration when using the power supply.

Inrush current	When the power supply switch is first turned on, an inrush current is generated. Ensure there is enough power available for the power supply when first turned on, especially if a number of units are turned on at the same time.
----------------	--

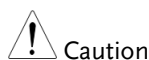

Cycling the power on and off quickly can cause the inrush current limiting circuit to fail as well as reduce the working life of the input fuse and power switch.

Pulsed or Peaked loads	When the load has current peaks or is pulsed, it is possible for the maximum current to exceed the mean current value. The PFR-100 power supply ammeter only indicates mean current values, which means for pulsed current loads,
------------------------	---

the actual current can exceed the indicated value. For pulsed loads, the current limit must be increased, or a power supply with a greater capacity must be chosen. As shown below, a pulsed load may exceed the current limit and the indicated current on the power supply ammeter.

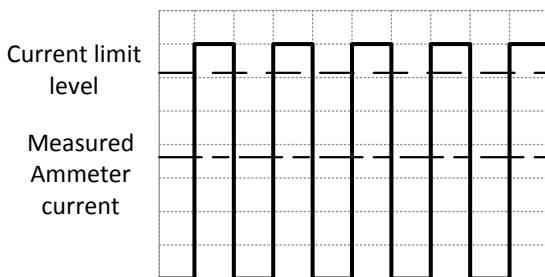

Note

The LED message showed on the display will vary depending on the F-17 setting.

Reverse Current: Regenerative load

When the power supply is connected to a regenerative load such as a transformer or inverter, reverse current will feed back to the power supply. The PFR-100 power supply cannot absorb reverse current. For loads that create reverse current, connect a resistor in parallel (dummy load) to the power supply to bypass the reverse current. To calculate the resistance for the dummy resistor, R_D , first determine the maximum reverse current, I_R , and determine what the output voltage, E_O , will be.

$$R_D(\Omega) \leq E_O(V) \div I_R(A)$$

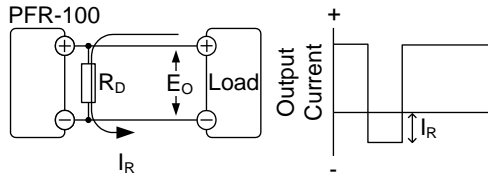

Note

The current output will decrease by the amount of current absorbed by the resistor.

Ensure the resistor used can withstand the power capacity of the power supply/load.

Reverse Current:
Accumulative
energy.

When the power supply is connected to a load such as a battery, reverse current may flow back to the power supply. To prevent damage to the power supply, use a reverse-current-protection diode in series between the power supply and load.

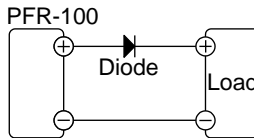

CAUTION

Ensure the reverse withstand voltage of the diode is able to withstand 2 times the rated output voltage of the power supply and the forward current capacity can withstand 3 to 10 times the rated output current of the power supply.

Ensure the diode is able to withstand the heat generated in the following scenarios.

When the diode is used to limit reverse voltage, remote sensing cannot be used.

Grounding

The output terminals of the PFR-100 power supplies are isolated with respect to the protective grounding terminal. The insulation capacity of the load, the load cables and other connected devices must be taken into consideration when connected to the protective ground or when floating.

Floating

As the output terminals are floating, the load and all load cables must have an insulation capacity that is greater than the isolation voltage of the power supply.

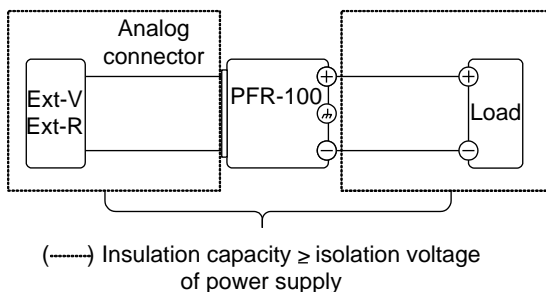

If the insulation capacity of the load and load cables are not greater than the isolation voltage of the power supply, electric shock may occur.

Grounded output terminal

If the positive or negative terminal is connected to the protective ground terminal, the insulation capacity needed for the load and load cables is greatly reduced. The insulation capacity only needs to be greater than the maximum output voltage of the power supply with respect to ground.

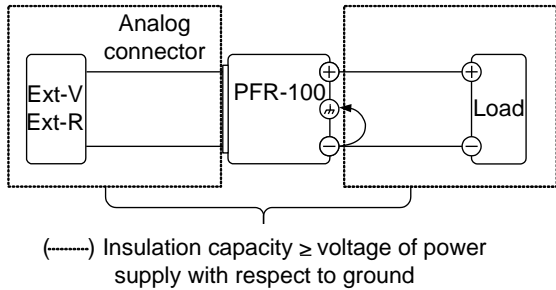

 **CAUTION**

If using external voltage control, do not ground the external voltage terminal as this will create a short circuit.

OPERATION

Set Up	33
Power Up.....	33
Wire Gauge Considerations	34
Output Terminals.....	35
Connection with the rear panel output terminal	35
Connection with the front panel output terminal	37
Using the Output Terminal Cover.....	38
Using the Rack Mount Kit	39
How to Use the Instrument.....	39
Reset to Factory Default Settings.....	40
View System Version and Build Date	42
Basic Operation	44
Setting OVP/OCP/UVL Levels.....	44
Set to C.V. Priority Mode	47
Set to C.C. Priority Mode	50
Display Modes	53
Panel Lock.....	54
Save Setup	54
Recall Setup.....	55
Remote Sensing.....	56
Test Scripts	58
Test Script File Format	59
Test Script Settings	59
Setting the Test Script Settings	60
Load Test Script	61
Run Test Script.....	62
Export Test Script.....	64
Remove Test Script.....	65

Set Up

Power Up

Background Make sure that the power source is shut off.

Use the AC power cable supplied with the product.

Steps

1. Connect the power cord to the rear panel socket.

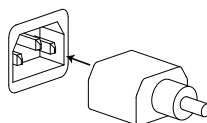

2. Press the POWER switch on. If used for the first time, the default settings will appear on the display, otherwise The PFR-100 recovers the state right before the power was last turned OFF. For default configuration settings, see page 136.

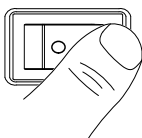

CAUTION

Do not turn the power on and off quickly. Please wait for the display to fully turn off.

Wire Gauge Considerations

Background Before connecting the output terminals to a load, the wire gauge of the cables should be considered. It is essential that the current capacity of the load cables is adequate. The rating of the cables must equal or exceed the maximum current rated output of the instrument.

Recommended wire gauge

Wire Gauge	Nominal Cross Section	Maximum Current
20	0.5	9
18	0.75	11
18	1	13
16	1.5	18
14	2.5	24
12	4	34
10	6	45

The maximum temperature rise can only be 60 degrees above the ambient temperature. The ambient temperature must be less than 30 degrees.

Output Terminals

Connection with the rear panel output terminal

Background The PFR-100 series use a 10 pin socket for the output voltage and sense connections. The corresponding plugs (DECA SwitchLab MC420-38110Z) should be used to connect the terminals to the appropriate cable.

Before connecting the output terminals to the load, first consider whether voltage sense will be used, the gauge of the cable wiring and the withstand voltage of the cables and load.



WARNING

Dangerous voltages. Ensure that the power to the instrument is disabled before handling the power supply output terminals. Failing to do so may lead to electric shock.

Output Connector Overview When using the rear panel output terminal, make sure the wires that are used follow the following guidelines:

Wire gauge:	AWG 26 to AWG 16
Strip length:	6.5mm // 0.26 in.
Current rating:	10A
Insulation withstand voltage:	AC 2000V min
Insulation resistance:	>2000MΩDC500V
Operation Temperature:	-40°C to +105°C

Output Connector
Pinout

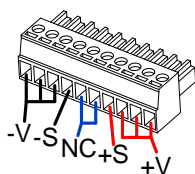

- V: -V terminals (x3)
- S: -Sense terminal
- NC: Not connected (x2)
- +S: +Sense terminal
- +V: +V terminals (x3)

Wiring the
Connector Plug

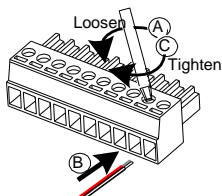

Unscrew the appropriate terminal anticlockwise to release the receptacle.

Insert a wire that has had at least ~6.5mm stripped from the insulation.

Tighten the receptacle by screwing clockwise.

Steps

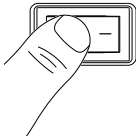
1. Turn the power switch off. 
2. Remove the rear panel output terminal cover
3. Choose a suitable wire gauge for the load cables.
4. Use flathead screwdriver to connect the load cable and output terminal.

5. Connect the positive load cable to the positive output terminal and the negative cable to the negative output terminal.

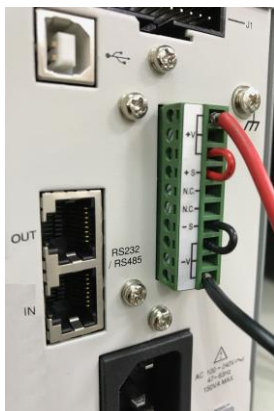

6. If using voltage sense, remove the sense terminal joining cables and connect sensing wires to the load(s).
7. Reattach the output terminal cover.

Connection with the front panel output terminal

Steps

1. Turn the power switch off.

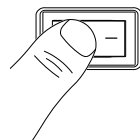

2. Connect the test lead includes in the accessory parts to front panel output terminal.
3. Fix the load cables firmly to eliminate loose connections from the front output terminals and load cables.

**WARNING**

For safety, Never output power through both the front and rear output terminals.

Using the Output Terminal Cover

- Steps
1. Screw the bottom cover onto the rear panel using the two M3 screws.
 2. Slide the top cover over the bottom cover.
 3. Finally, secure the top cover with the screw in the center of the top cover.
-

Removal

Reverse the procedure to remove the terminal covers.

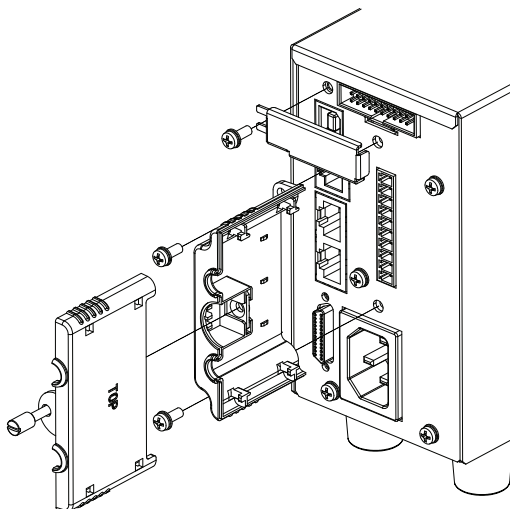

Using the Rack Mount Kit

Background The PFR-100 series has an optional Rack Mount Kit (GW Instek part number: [JIS] GRA-431-J, [EIA] GRA-431-E[EIA]) that can be used to hold 5 units into rack.

Rack mount diagram



How to Use the Instrument

Background The PFR-100 power supplies use a novel method of configuring parameter values only using the voltage or current knobs. The knobs are used to quickly edit parameter values at different unit steps at a time.

When the user manual says to set a value or parameter, use the steps below.

Example Use the Voltage knob to set a voltage of 10.05 volts.

1. Repeatedly press the Voltage knob until the least significant digit is highlighted. This will allow the voltage to be edited in 0.01 volt steps.

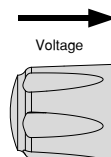

- Turn the Voltage knob till 0.05 volts is shown on the voltage display.

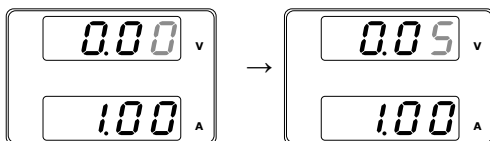
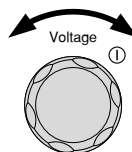

- Repeatedly press the Voltage knob until the first digit is highlighted. This will allow the voltage to be edited in 1 volt steps.
- Turn the Voltage knob until 10.05 is shown.

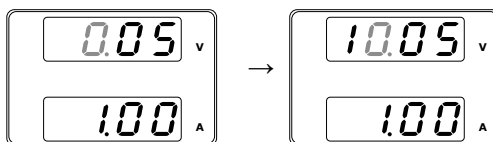

Note

Notice the Set key becomes illuminated when setting the current or voltage.

If the voltage or current knobs are unresponsive, press the Set key first.

Reset to Factory Default Settings

Background

The F-88 configuration setting allows the PFR-100 to be reset back to the factory default settings. See page 136 for the default factory settings.

Steps

- Press the Function key. The Function key will light up.

Function



- The display should show F-01 on the top and the configuration setting for F-01 on the bottom.



- Rotate the Voltage knob to change the F setting to F-88 (Factory Set Value).

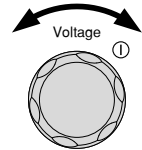

- Use the Current knob to set the F-88 setting to 1 (Return to factory default settings).

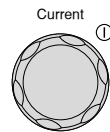

- Press the Voltage knob to confirm. ConF will be displayed when it is configuring.

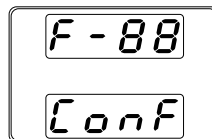
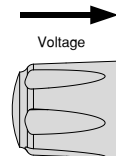

- Press the Function key again to exit. The Function key light will turn off.



View System Version and Build Date

Background The F-89 configuration setting allows you to view the PFR-100 version number, build date, keyboard version, analog-control version.

- Steps**
1. Press the Function key. The Function key will light up. 
 2. The display should show F-01 on the top and the configuration setting for F-01 on the bottom.

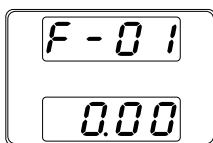

3. Rotate the Voltage knob to change the F setting to F-89 (Show Version).

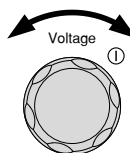

4. Rotate the Current knob to view the version and build date for the various items.

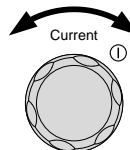

- F-89**
- 0-XX: Version (1/2)
 - 1-XX: Version (2/2)
 - 2-XX: Build On-Year. (1/2)
 - 3-XX: Build On-Year. (2/2)
 - 4-XX: Build On-Month.
 - 5-XX: Build On-Day.
 - 6-XX: Keyboard CPLD. (1/2)
 - 7-XX: Keyboard CPLD. (2/2)
 - 8-XX: Analog Board CPLD. (1/2)
 - 9-XX: Analog Board CPLD. (2/2)

5. Press the Function key again to exit. The Function key light will turn off.



Example Main Program Version: V01.00, 2017/06-01

- 0-01: Version
1-00: Version
2-20: Build On-Year.
3-17: Build On-Year.
4-06: Build On-Month.
5-01: Build On-Day.

Example Keyboard CPLD Version: 0x3305

- 6-33: Keyboard CPLD Version.
7-05: Keyboard CPLD Version.

Example Analog CPLD Version: 0x0408

- 8-04: Analog CPLD Version.
9-08: Analog CPLD Version.
-

Basic Operation

This section describes the basic operations required to operate the power supply.

Setting OVP/OCP → from page 44

C.V. priority mode → from page 47

C.C. priority mode → from page 50

Display mode → page 53

Panel lock → page 54

Save setups → from page 54

Recall setups → from page 55

Remote sensing → from page 56

Before operating the power supply, please see the Getting Started chapter, page 9.

Setting OVP/OCP/UVL Levels

Background

The OVP level and OCP level has a selectable range that is based on the output voltage and output current, respectively. The OVP and OCP level is set to the highest level by default. The actual selectable OVP and OCP range depends on the PFR-100 model.

When one of the protection measures are on, ALM indicator is lit red on the front panel and the type of alarm is also shown on the display. The ALM_CLR button can be used to clear any protection functions that have been tripped. By default, the output will turn off when the OVP or OCP protection levels are tripped.

The UVL will prevent you from setting a

voltage that is less than the UVL setting. The UVL setting range is from 0% ~ 105% of the rated output voltage.

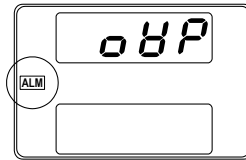

Example: OVP alarm

Before setting the protection settings:

- Ensure the load is not connected.
- Ensure the output is turned off.



Note

You can use the Function settings (F-13 and F-14) to apply limits to the voltage and current settings, respectively. You can set limitations so that the values do not exceed the set OVP and the set OCP level, and so that the values are not lower than the set UVL trip point.

By using this feature, you can avoid turning the output off by mistakenly setting the voltage or current to a value that exceeds the set OVP or OCP level or to a value that is lower than the set UVL trip point.

If you have selected to limit the voltage setting (F-14), you will no longer be able to set the output voltage to a value that is above about 95% of the OVP trip point or to a value that is lower than the UVL trip point.

If you have selected to limit the current setting (F-13), you will no longer be able to set the output current to a value that is above about 95% of the OCP trip point.

- Steps
1. Press the PROT key. The PROT key lights up. 
 2. The OVP protection function will be displayed on the voltage display and the setting will be displayed on the current display.

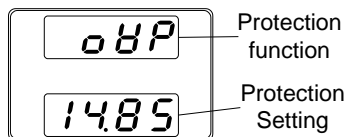

Choose a Protection Function

3. Use the Voltage knob to select a protection function.

Range OVP, OCP, UVL

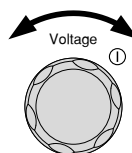

Setting the Protection Level

4. Use the Current knob to set the protection level for the selected function.

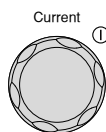

Model	Setting Range		
	OCP	OVP	UVL
PRF-100L	1~11	5~55	0~52.5
PRF-100M	0.2~2.2	5~275	0~262.5

5. Press PROT again to exit. The PROT key light will turn off.



Clear OVP/OCP/UVL protection

The OVP, OCP or UVL protection can be cleared after it has been tripped by holding the ALM_CLR button for 3 seconds.



Set to C.V. Priority Mode

When setting the power supply to constant voltage mode, a current limit must also be set to determine the crossover point. When the current exceeds the crossover point, the mode switches to C.C. mode. For details about C.V. operation, see page 22. C.C. and C.V. mode have two selectable slew rates: High Speed Priority and Slew Rate Priority. High Speed Priority will use the fastest slew rate for the instrument while Slew Rate Priority will use a user-configured slew rate.

Background	Before setting the power supply to C.V. mode, ensure: The output is off. The load is connected.
------------	---

- | | | |
|-------|---|---|
| Steps | <ol style="list-style-type: none"> Press the Function key. The Function key will light up. |  |
| | <ol style="list-style-type: none"> The display should show F-01 on the top and the configuration setting for F-01 on the bottom. | |



- Rotate the Voltage knob to change the F setting to F-03 (V-I Mode Slew Rate Select).

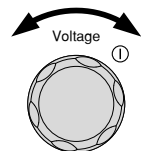

4. Use the Current knob to set the F-03 setting.

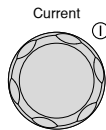

Set F-03 to 0 (CV High Speed Priority) or 2 (CV Slew Rate Priority).

F-03 0 = CV High Speed Priority
 2 = CV Slew Rate Priority

5. Press the Voltage knob to save the configuration setting. ConF will be displayed when successful.

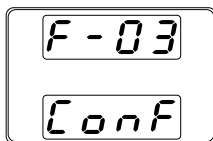
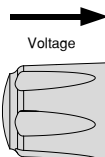

6. If CV Slew Rate Priority was chosen as the operating mode, repeat steps 3~5 to set F-04 (Rising Voltage Slew Rate) and the F-05 (Falling Voltage Slew Rate) and save.

F-04 / F-05 0.1V/s~100.0V/s (PFR-100L)
 0.1V/s~500.0V/s (PFR-100M)

7. Press the Function key again to exit the configuration settings. The function key light will turn off.



8. Use the Current knob to set the current limit (crossover point).

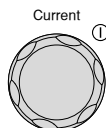

9. Use the Voltage knob to set the voltage.

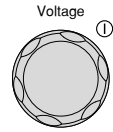

Note

Notice the Set key becomes illuminated when setting the current or voltage. If the Voltage or Current knobs are unresponsive, press the Set key first.

10. Press the Output key. The Output key becomes illuminated.

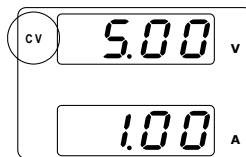
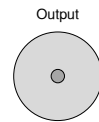

CV will become illuminated (top left)



Note

Only the voltage level can be altered when the output is on. The current level can only be changed by pressing the Set key.

For more information on the Normal Function Settings, see page 71.

Set to C.C. Priority Mode

When setting the power supply to constant current mode, a voltage limit must also be set to determine the crossover point. When the voltage exceeds the crossover point, the mode switches to C.V. mode. For details about C.C. operation, see page 22. C.C. and C.V. mode have two selectable slew rates: High Speed Priority and Slew Rate Priority. High Speed Priority will use the fastest slew rate for the instrument while Slew Rate Priority will use a user-configured slew rate.

Background	Before setting the power supply to C.C. mode, ensure: <ul style="list-style-type: none"> • The output is off. • The load is connected.
------------	--

Steps	<ol style="list-style-type: none"> 1. Press the Function key. The Function key will light up. <div data-bbox="799 746 891 810" data-label="Image"> </div> 2. The display should show F-01 on the top and the configuration setting for F-01 on the bottom.
-------	---



3. Rotate the Voltage knob to change the F setting to F-03 (V-I Mode Slew Rate Select).

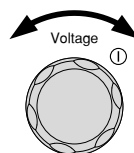

4. Use the Current knob to set the F-03 setting.

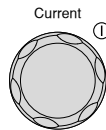

Set F-03 to 1 (CC High Speed Priority) or 3 (CC Slew Rate Priority) and save.

F-03 1 = CC High Speed Priority
 3 = CC Slew Rate Priority

5. Press the Voltage knob to save the configuration setting. ConF will be displayed when successful.

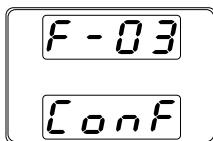
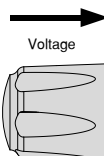

6. If CC Slew Rate Priority was chosen as the operating mode, set F-06 (Current Slew Rate Up) and F-07 (Current Slew Rate Down) and save.

F-06 / F-07 0.01A/s ~ 20.00A/s (PFR-100L)
 0.001A/s ~ 4.000A/s (PFR-100M)

7. Press the Function key again to exit the configuration settings. The Function key light will turn off.



8. Use the Voltage knob to set the voltage limit (crossover point).

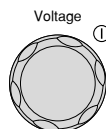

9. Use the Current knob to set the current.

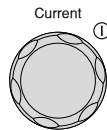

Note

Notice the Set key becomes illuminated when setting the current or voltage. If the Voltage or Current knobs are unresponsive, press the Set key first.

10. Press the Output key. The Output key becomes illuminated.

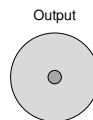

CC will become illuminated (bottom left)



Note

Only the current level can be altered when the output is on. The voltage level can only be changed by pressing the Set key.

For more information on the Normal Function Settings, see page 71.

Display Modes

The PFR-100 series power supplies allow you to view the output in three different modes: voltage and current, voltage and power or current and power.

Steps

1. Hold the PWR_DSPL key for 3 seconds. The display changes to voltage and power (V/W).  PWR_DSPL
2. To switch between displaying A/W and V/W, simply press the corresponding Voltage or Current knob.

For example: when in A/W mode, press the Voltage knob to display V/W. Conversely when in V/W mode, press the Current knob to display A/W.

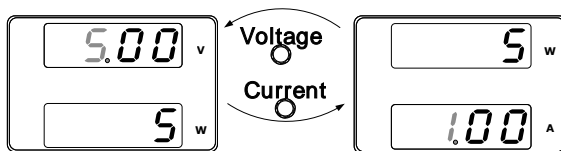

- When V/W is displayed, the Voltage knob can still be used to change the voltage level.
 - When A/W is displayed, the Current knob can still be used to change the current level.
-

Exit



Hold the PWR_DSPL key again for 3 seconds return to normal display mode.  PWR_DSPL

Panel Lock

The panel lock feature prevents settings from being changed accidentally. When activated, the Lock/Local key will become illuminated and all keys and knobs except the Lock/Local key and Output key (if active) will be disabled.



If the instrument is remotely controlled via the USB/LAN interface, the panel lock is automatically enabled.

Activate the panel lock	Press the Lock/Local key to activate the panel lock. The key will become illuminated.	Lock/Local 
-------------------------	---	---

Disable the panel lock	Hold the Lock/Local key for ~3 seconds to disable the panel lock. The key's light will turn off.	Lock/Local  Unlock 
------------------------	--	--

Save Setup

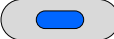
The PFR-100 has 3 dedicated keys (M1, M2, M3) to save the set current, set voltage, OVP, OCP and ULV settings.

Save Setup	<ol style="list-style-type: none"> 1. Press the SHIFT key. The shift key will light blue. 2. Hold the desired memory key for >3 seconds (M1, M2, M3). 	  Function  M1 (hold)
------------	--	--

- When the setup is saved the unit will beep, the setup will be saved and the memory number will be shown on the display.

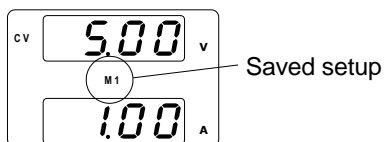

Recall Setup

The PFR-100 has 3 dedicated keys (M1, M2, M3) to recall setups.

Recall Setup

- Press the SHIFT key. The shift key will light blue.



- Press the desired memory key to recall the desired setup (M1, M2, M3).



M1

- When the setup is recalled the setup will be loaded and the memory number will be shown on the display.

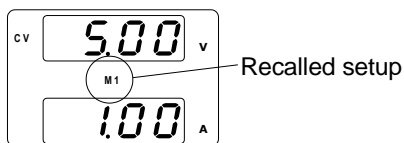

Note

The F-15 function setting will determine whether the saved contents of the recalled memory setting are displayed or not.

Remote Sensing

Remote sense is used to compensate for the voltage drop seen across load cables due to the resistance inherent in the load cables. The remote sense terminals are connected to the load terminals to determine the voltage drop across the load cables.

Remote sense can compensate up to 1 volts for PFR-100L and PFR-100M (compensation voltage). Load cables should be chosen with a voltage drop less than the compensation voltage.



WARNING

Ensure the output is off before handling the remote sense connector.

Use sense cables with a voltage rating exceeding the isolation voltage of the power supply.

Never connect sensing cables when the output is on. Electric shock or damage to the power supply could result.

Output terminal Connector Overview

When using the remote sensing, make sure the wires that are used follow the following guidelines:

Wire gauge: AWG 26 to AWG 16

Strip length: 6.5mm // 0.26 in.

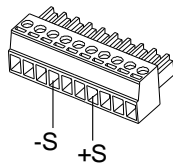

+S: +Sense terminal

-S: -Sense terminal



Note

Be sure to remove the Sense joining cables so the units are not using local sensing.

Single Load

1. Connect the +S terminal to the positive potential of the load. Connect the -S terminal to the negative potential of the load.

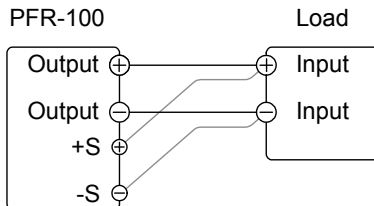

2. Operate the instrument as normal. See the Basic Operation chapter for details.

Wire Shielding and Load line impedance

To help to minimize the oscillation due to the inductance and capacitance of the load cables, use an electrolytic capacitor in parallel with the load terminals.

To minimize the effect of load line impedance use twisted wire pairing.

Shield the sense wires and connect the shield to the chassis ground.

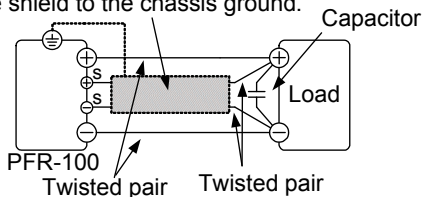

Test Scripts

This section describes how to use the Test function to run, load and save test scripts for automated testing. The Test function is useful if you want to perform a number of tests automatically. The PFR-100 test function can store one test scripts in memory.

Each test script is programmed in a scripting language. For more information on how to create test scripts, please contact GW Instek.

Test script file format → from page 59

Test script settings → from page 59

Setting the test script settings → from page 60

Load test script → from page 61

Run test script → from page 62

Export test script → from page 64

Remove test script → from page 65

Test Script File Format

Background	The test files are saved in *.tst file format. Each file is saved as tXXX.tst, where XXX is the save file number 001~010.
------------	--

Test Script Settings

Test Run	Runs test script from the internal memory. A script must first be loaded into the internal memory before it can be run. Only one script can be loaded into the internal memory at the same time. See the test function Test Load, below. The script will run as soon as the test function is started. T-01 "n" or "y"
Test Load	Loads a test script from the USB drive to the internal memory. A script must first be loaded into internal memory before it can be run. T-02 1~10 (USB→PFR-100)
Test Export	Exports the script from internal memory to the USB drive. T-03 1~10 (PFR-100→USB)
Test Remove	Deletes the test file from the PFR-100 internal memory. T-04 "n" or "y"
Available Test Memory	Shows the amount of space left in memory for tests.

T-05 Displays the available memory in bytes.

Setting the Test Script Settings

Steps The test script settings (T-01~T-04) are set with the Test key.

1. Press the Test key. The Test key will light up.



2. The display will show T-01 on the top and the memory indication on the bottom. The bottom of the screen will indicate whether the memory has a script loaded, "y" (yes) or "n" (no).

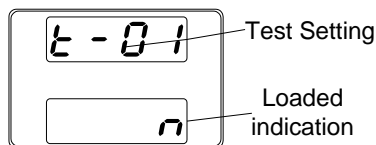

3. Rotate the Voltage knob to change the T setting (Test setting).

Test Run	T-01
Test Load	T-02
Test Export	T-03
Test Remove	T-04
Available Test Memory	T-05

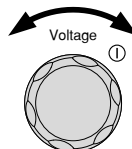

4. Rotate the Current knob to choose a memory number.

Range 1~10

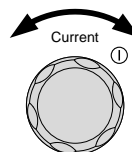

5. Press the Voltage knob to complete the setting.

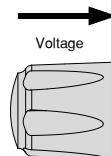

- Exit Press the Test key again to exit the Test settings. The Test key light will turn off.



Load Test Script

- Overview Before a test script can be run, it must first be loaded into the internal memory. Before loading a test script into memory:
- Ensure the script file is placed in the root directory.

- Steps 1. Insert a USB flash drive into the front panel USB-A slot. Ensure the flash drive contains a test script in the root directory.

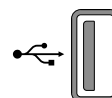

2. Turn on the power. MS (Mass Storage) will be displayed on the screen after a few seconds if the USB drive is recognized.

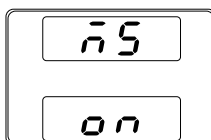

Note

If the USB drive is not recognized, check to see that the function settings for F-20 = 1 (page 74). If not, reinsert the USB flash drive. If you want to use the USB flash driver, F29 can't be set to 3 or 7.

- Configure T-02 (Test Load) to load Page 60 test script to internal memory.

T-02 range 1~10 (t001 ~t010)

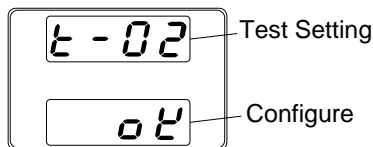
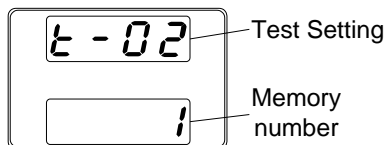

- The script will now be available in the internal memory.



Error messages: If you load a file that is not present on the USB drive “Err 002” will be displayed on the display.

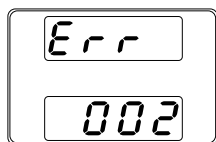

Run Test Script

Overview

A test script can be run from the internal memory.

Steps

- Before a test script can be run, it must first be loaded into the internal memory. Page 61

2. Configure T-01 (Run Test) Page 60
3. If there are no errors during loading, the script engine will enter the wait state. The wait state indicates that the unit is ready to execute the script.

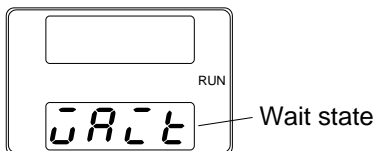

- To execute the script, press the Output key. The Output key becomes illuminated.
- When the script is executing, the measurement results will display as normal.
- The Test LED will flash.

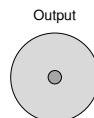

When a script is running, press the Output key again to return the script engine to the wait state.



When the script is running, press the Test key to abort the execution of the script and return to normal operating mode. The Test LED will turn off after the script has been aborted.

Export Test Script

Overview

The Export Test function saves the test file to the root directory of a USB flash drive.

- Files will be saved as tXXX.tst where XXX is the file number 001~010 from which the test script was exported to.
 - Files of the same name on the USB flash drive will be written over.
-

Steps

1. Insert a USB flash drive into the front panel USB-A slot.

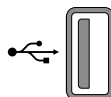

2. Turn on the power. MS (Mass Storage) will be displayed on the screen after a few seconds if the USB drive is recognized.

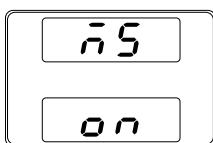

Note

If the USB drive is not recognized, check to see that the function settings for F-20 = 1 (page 74). If not, reinsert the USB flash drive. If you want to use the USB flash driver, F29 can't be set to 3 or 7.

3. Configure T-03 (Test Export) to 0~10 (save test file to USB flash driver)

Page 60

T-03 range 1~10

4. The script will now be copied to the USB flash drive.
-



Note

Error messages: If you load a file that is not present on the USB drive “Err 003” will be displayed on the display. If you try to export a test script from an empty memory location “Err 003” will be displayed on the display.

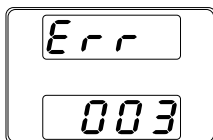

Remove Test Script

Overview The Remove Test function will delete the test script from the internal memory.

- Steps**
1. Select T-04 (Test Remove) and Press Voltage knob to configure. Page 60
 2. The test script will be removed from the internal memory.

Checking the Available Memory

Overview The T-05 function displays the amount of internal memory that is left on the unit to load test scripts. The displayed units are in kilobytes (1024 bytes).

- Steps** Select T-05 (Available Test Memory). The available memory in kilobytes is displayed.

C ONFIGURATION

Configuration Overview	67
Configuration Table.....	67
Normal Function Settings	70
Interface Configuration Settings	74
USB / GPIB Settings	74
LAN Settings	75
UART Settings	76
System Settings	77
Power On Configuration Settings	78
Special Function	79
Setting Normal Function Settings.....	79
Setting Power On Configuration Settings	81

Configuration Overview

Configuration of the PFR-100 power supplies is divided into five different configuration settings: Normal Function, Interface Configuration Settings, System Configuration Settings, Power ON Configuration and Special Function Settings. Power ON Configuration differs from the other settings in that the settings used with Power ON Configuration settings can only be set during power up. The other configuration settings can be changed when the unit is already on. This prevents some important configuration parameters from being changed inadvertently. Power On Configuration settings are numbered F-90 to F-94 and the other configuration settings are numbered F-00 to F-61, F-71 to F-78 and F-88 to F-89. The Special Function Settings are used for calibration, firmware updated and other special functions; these functions are not supported for end-user use.

Configuration Table

Please use the configuration settings listed below when applying the configuration settings.

Normal Function Settings	Setting	Setting Range
Output ON delay time	F-01	0.00s~99.99s
Output OFF delay time	F-02	0.00s~99.99s
V-I mode slew rate select	F-03	0 = CV high speed priority (CVHS) 1 = CC high speed priority (CCHS) 2 = CV slew rate priority (CVLS) 3 = CC slew rate priority (CVLS)
Rising voltage slew rate	F-04	0.1V/s ~ 100.0V/s (PFR-100L) 0.1V/s ~ 500.0V/s (PFR-100M)
Falling voltage slew rate	F-05	0.1V/s ~ 100.0V/s (PFR-100L) 0.1V/s ~ 500.0V/s (PFR-100M)
Rising current slew rate	F-06	0.01A/s ~ 20.00A/s (PFR-100L) 0.001A/s ~ 4.000A/s (PFR-100M)
Falling current slew rate	F-07	0.01A/s ~ 20.00A/s (PFR-100L) 0.001A/s ~ 4.000A/s (PFR-100M)
Bleeder circuit control	F-09	0 = OFF, 1 = ON, 2 = AUTO

Buzzer ON/OFF control	F-10	0 = OFF, 1 = ON
Detection Time of OCP	F-12	0.0 ~ 2.0 sec
Current Setting Limit (I-Limit)	F-13	0 = OFF (The limit function of current setting is disabled.) 1 = ON (The limit function of current setting is enabled.)
Voltage Setting Limit (V-Limit)	F-14	0 = OFF (The limit function of voltage setting is disabled.) 1 = ON (The limit function of voltage setting is enabled.)
Memory Recall Display	F-15	0 = OFF, 1 = ON
Measurement Average Setting	F-17	0 = Low, 1 = Middle, 2 = High
Lock Mode	F-19	0:Lock Panel, Allow Output OFF 1:Lock Panel, Allow Output ON/OFF
USB/GPIB Settings		
Front panel USB status	F-20	0 = None, 1 = Mass Storage
Rear panel USB status	F-21	0 = None, 1 = Linking to PC
GPIB Address	F-23	0 ~ 30
Show GPIB available status	F-25	0 = No GPIB, 1 = GPIB is available
Interface Select	F-29	0 = Disable, 1 = RS232, 2 = RS485, 3 = USB-CDC / NO Mass Storage, 4 = GPIB, 5 = LAN SOCKET, 6 = LAN WEB
LAN Settings		
MAC Address-1	F-30	0x00~0xFF
MAC Address-2	F-31	0x00~0xFF
MAC Address-3	F-32	0x00~0xFF
MAC Address-4	F-33	0x00~0xFF
MAC Address-5	F-34	0x00~0xFF
MAC Address-6	F-35	0x00~0xFF
DHCP	F-37	0 = OFF, 1 = ON
IP Address-1	F-39	0~255
IP Address-2	F-40	0~255
IP Address-3	F-41	0~255
IP Address-4	F-42	0~255
Subnet Mask-1	F-43	0~255
Subnet Mask-2	F-44	0~255

Subnet Mask-3	F-45	0~255
Subnet Mask-4	F-46	0~255
Gateway-1	F-47	0~255
Gateway-2	F-48	0~255
Gateway-3	F-49	0~255
Gateway-4	F-50	0~255
DNS address-1	F-51	0~255
DNS address-2	F-52	0~255
DNS address-3	F-53	0~255
DNS address-4	F-54	0~255
Web Password Enable/Disable	F-60	0 = Disable, 1 = Enable
Web Enter Password	F-61	0000~9999
UART Settings		
UART Baud Rate	F-71	0 = 1200, 1 = 2400, 2 = 4800, 3 = 9600, 4 = 19200, 5 = 38400, 6 = 57600, 7 = 115200
UART Data Bits	F-72	0 = 7 bits, 1 = 8 bits
UART Parity	F-73	0 = None, 1 = Odd, 2 = Even
UART Stop Bit	F-74	0 = 1 bit, 1 = 2 bits
UART TCP	F-75	0 = SCPI, 1 = TDK(emulation mode)
UART Address	F-76	00 ~ 30
UART Multi-Drop control	F-77	0 = Disable, 1 = Master, 2 = Slave, 3 = Display information
UART Multi-Drop status	F-78	Displayed parameter: AA-S AA: 00~30 (Address), S: 0~1 (Off-line/On-line status).
System Settings		
Factory Default Configuration	F-88	0 = None 1 = Return to factory default settings
Show Version	F-89	0, 1 = Version 2, 3, 4, 5 = Build date (YYYYMMDD) 6, 7 = Keyboard CPLD Version 8, 9 = Analog-Control CPLD Version

Power On Configuration Settings*		
CV Control	F-90	0 = Panel control (local) 1 = External Voltage control 2 = External Resistance control- Rising ↙ 3 = External Resistance control- Falling ↘
CC Control	F-91	0 = Panel control (local) 1 = External Voltage control 2 = External Resistance control- Rising ↙ 3 = External Resistance control- Falling ↘
Power ON Output	F-92	0 = Safe Mode (Output OFF at startup) 1 = Force Mode (Output ON at startup) 2 = Auto Mode (Status before last time Power OFF)
External Output Logic Control	F-94	0 = High ON, 1 = Low ON, 2 = Disable
Special Function		
Special Function	F-00	0000 ~ 9999



Note

Power On Configuration settings can only be set during power up. They can, however, be viewed under normal operation.

Normal Function Settings

Output ON Delay Time

Delays turning the output on for a designated amount of time. The Delay indicator will light when the Delay time is not 0.

Note: The Output ON Delay Time setting has a maximum deviation (error) of 20ms.

The Output ON Delay Time setting is disabled when the output is set to external control.

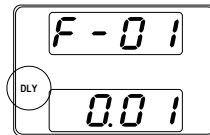

F-01 0.00s~99.99s

Output OFF Delay Time

Delays turning the output off for a designated amount of time. The Delay indicator will light when the Delay time is not 0.

Note: The Output OFF Delay Time setting has a maximum deviation (error) of 20ms.

The Output OFF Delay Time setting is disabled when the output is set to external control.

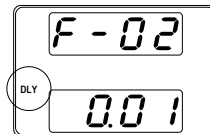

F-02 0.00s~99.99s

V-I Mode Selects High Speed Priority or Slew Rate Priority for CV or CC mode. The voltage or current slew rate can only be edited if CC/CV Slew Rate Priority is selected. The ISR indicator will be lit for CC Slew Rate Priority and the VSR indicator will be lit for CV Slew Rate Priority.

Note: CC and CV Slew Rate Priority mode are disabled when voltage/current output is set to external control.

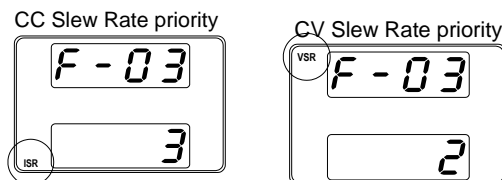

- F-03 0 = CV high speed priority
 1 = CC high speed priority
 2 = CV slew rate priority
 3 = CC slew rate priority

Rising Voltage Slew Rate Only applicable if V-I Mode is set to CV Slew Rate Priority. (F-03 must be 2)
 F-04 0.1V/s ~ 100.0V/s (PFR-100L)
 0.1V/s ~ 500.0V/s (PFR-100M)

Falling Voltage Slew Rate Only applicable if V-I Mode is set to CV Slew Rate Priority. (F-03 must be 2)
 F-05 0.1V/s ~ 100.0V/s (PFR-100L)
 0.1V/s ~ 500.0V/s (PFR-100M)

Rising Current Slew Rate Only applicable if V-I Mode is set to CC Slew Rate Priority. (F-03 must be 3)
 F-06 0.01A/s ~ 20.00A/s (PFR-100L)
 0.001A/s ~ 4.000A/s (PFR-100M)

Falling Current Slew Rate	<p>Only applicable if V-I Mode is set to CC Slew Rate Priority. (F-03 must be 3)</p> <p>F-07 0.01A/s ~ 20.00A/s (PFR-100L) 0.001A/s ~ 4.000A/s (PFR-100M)</p>
Bleeder ON/OFF	<p>Bleeder control turns ON/OFF the bleeder resistor. When set to AUTO the bleeder resistor is automatically turned on when the output is turned on and turned off when the output or power is turned off.</p> <p>F-09 0 = OFF, 1 = ON, 2 = AUTO</p>
Buzzer ON/OFF	<p>Turns the buzzer sound on or off. The buzzer is associated with alarm sounds and keypad entry sounds.</p> <p>F-10 0 = OFF, 1 = ON</p>
Detection Time of OCP	<p>This parameter will delay the amount of time it takes to trigger the over current protection. (Resolution is 0.1s) This function can be useful to prevent current overshoot from triggering OCP.</p> <p>F-12 0.0 ~ 2.0 sec</p>
Current Setting Limit (I-limit)	<p>If the parameter sets to "1 = ON", limit the setting of output current not exceed the OCP setting value (approximately 95 % of the OCP trip point).</p> <p>If the parameter sets to "0 = OFF", when output current exceed the OCP value, the OCP function will be activated.</p> <p>F-13 0 = OFF (The limit function of current setting is disabled.) 1 = ON (The limit function of current setting is enabled.)</p>

Voltage Setting Limit	<p>If the parameter sets to "1 = ON", limit the setting of output voltage not exceed the OVP setting value (approximately 95 % of the OVP trip point).</p> <p>If the parameter sets to "0 = OFF", when output voltage exceed the OVP value, the OVP function will be activated.</p> <p>F-14 0 = OFF (The limit function of voltage setting is disabled.) 1 = ON (The limit function of voltage setting is enabled.)</p>
-----------------------	---

Memory Recall Display	<p>Displays which memory setting is recalled (M1, M2 or M3) when recalling a setup.</p> <p>F-15 0 = OFF, 1 = ON</p>
-----------------------	--

Measurement Average Setting	<p>Sets the level of smoothing for the average setting.</p> <p>F-17 0 = Low, 1 = Middle, 2 = High</p>
-----------------------------	--

Lock Mode	<p>Sets the behavior of the Output key when the panel lock is on.</p> <p>F-19 0: Lock Panel, Allow Output OFF 1: Lock Panel, Allow Output ON/OFF</p>
-----------	--

Interface Configuration Settings

USB / GPIB Settings

Front Panel USB Status	<p>Displays the front panel USB-A port state. This setting is not configurable.</p> <p>F-20 0 = None, 1 = Mass Storage</p>
------------------------	---

Rear Panel USB Status	Displays the rear panel USB-B port state. This setting is not configurable. F-21 0 = None, 1 = Linking to PC
GPIB Address	Sets the GPIB address. F-23 0 ~ 30
Show GPIB available Status	Shows the status of the GPIB option port. F-25 0 = No GPIB, 1 = GPIB is available
Interface Select	Enables or disables the Interface port. Only one interface can be used at the same time. F-29 0 = Disable, 1 = RS232, 2 = RS485, 3 = USB-CDC / NO Mass Storage, 4 = GPIB, 5 = LAN SOCKET, 6 = LAN WEB

LAN Settings

Show MAC Address-1~6	Displays the MAC address in 6 parts. This setting is not configurable. F-30~F-35 0x00~0xFF
DHCP	Turns DHCP on or off. F-37 0 = Disable, 1 = Enable
IP Address-1~4	Sets the default IP address. IP address 1~4 splits the IP address into four sections. F-39~F42 0~255
Subnet Mask 1~4	Sets the subnet mask. The subnet mask is split into four parts. F-43~F46 0~255
Gateway 1~4	Sets the gateway address. The gateway address is split into 4 parts.

	F-47~F-50	0~255
DNS Address 1~4	Sets the DNS address. The DNS address is split into 4 parts.	
	F-51~ F-54	0~255
Web Password Enable/Disable	Turns a web password on/off.	
	F-60	0 = Disable, 1 = Enable
Web Password	Sets the web password.	
	F-61	0000 ~ 9999

UART Settings

UART Baud Rate	Sets the UART baud rate.	
	F-71	0 = 1200, 1 = 2400, 2 = 4800, 3 = 9600, 4 = 19200, 5 = 38400, 6 = 57600, 7 = 115200
UART Data Bits	Sets the number of data bits.	
	F-72	0 = 7 bits, 1 = 8 bits
UART Parity	Sets the parity.	
	F-73	0 = None, 1 = Odd, 2 = Even
UART Stop Bit	Sets the number of stop bits.	
	F-74	0 = 1 bit, 1 = 2 bits
UART TCP	UART transmission control protocol TCP settings.	
	F-75	0 = SCPI, 1 = TDK(emulation mode)
UART Address	Sets the UART address. This is used to set the address of a unit when using Multi-Drop remote control.	
	F-76	0 ~ 30

UART Multi-Drop control	<p>Set the master/slave/display-information parameters of a unit when using Multi-Drop remote control.</p> <p>F-77 0 = Disable, 1 = Master, 2 = Slave, 3 = Display Information</p>
UART Multi-Drop status	<p>Displays the Multi-Drop status on the master unit for each slave unit belonging to the Multi-Drop bus.</p> <p>F-78 Displayed parameter: AA-S AA: 00~30 (Address), S: 0~1 (Off-line/On-line status).</p>

System Settings

Factory Default Configuration	<p>Returns the PFR-100 to the factory default settings.</p> <p>F-88 0 = None, 1 = Return to factory default settings</p>
Show Version	<p>Displays the PFR-100 version number, build date, keyboard version, analog-control version, kernel build date.</p> <p>F-89 0, 1 = Version 2, 3, 4, 5 = Build Date (YYYYMMDD) 6, 7 = Keyboard CPLD Version 8, 9 = Analog board CPLD Version</p>

Power On Configuration Settings

CV Control	<p>Sets the constant voltage (CV) control mode between local and external voltage/resistance control.</p> <p>F-90 0 = Panel control (local) 1 = External Voltage control 2 = External Resistance control-Rising ↙ 3 = External Resistance control-Falling ↘</p> <hr/>
CC Control	<p>Sets the constant current (CC) control mode between local and external voltage/resistance control.</p> <p>F-91 0 = Panel control (local) 1 = External Voltage control 2 = External Resistance control-Rising ↙ 3 = External Resistance control-Falling ↘</p> <hr/>
Power ON Output	<p>Sets the power supply to turn the output on or off at power up.</p> <p>F-92 0 = Safe Mode (Output OFF at startup) 1 = Force Mode (Output ON at startup) 2 = Auto Mode (Status before last time Power OFF)</p> <hr/>
External Output Logic Control	<p>Sets the external output logic as active high or low, or disables the external output control function.</p> <p>F-94 0 = High ON, 1 = Low ON, 2 = Disable</p> <hr/>

Special Function

Special Function	The special function setting is used to access calibration, firmware updates and other special functions. The special function setting has a password that is used to access the special function menu. The password used determines which function is accessed. Please see your distributor for details. F-00 0000 ~ 9999
------------------	--

Setting Normal Function Settings

The Normal Function settings, F-01~F-61, F-71~F-78 and F-88~F-89 can be easily configured with the Function key.

- Ensure the load is not connected.
- Ensure the output is off.
- Function settings F-90~94 can only be viewed.



Note

Function setting F-89 (Show Version) can only be viewed, not edited.

Configuration settings F-90~ F-94 cannot be edited in the Normal Function settings. Use the Power On Configuration settings. See page 81 for details.

Steps

1. Press the Function key. The function key will light up.

Function



2. The display will show F-01 on the top and the configuration setting for F-01 on the bottom.



3. Rotate the Voltage knob to change the F setting.

Range F-00~F-61, F-70~F-78,
F-88~F-94

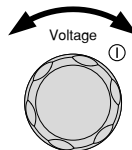

4. Use the Current knob to set the parameter for the chosen F setting.

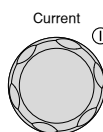

Press the Voltage knob to save the configuration setting. ConF will be displayed when it is configuring.

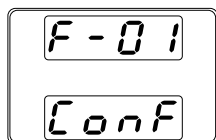
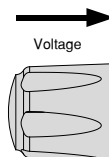

Exit

Press the Function key again to exit the configuration settings. The Function key light will turn off.



Setting Power On Configuration Settings

Background The Power On configuration settings can only be changed during power up to prevent the configuration settings being inadvertently changed.

- Ensure the load is not connected.
- Ensure the power supply is off.

Steps 1. Hold the Function key whilst turning the power on.

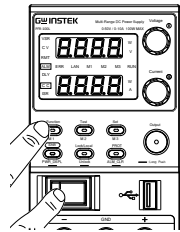

2. The display will show F-90 on the top and the configuration setting for F-90 on the bottom.

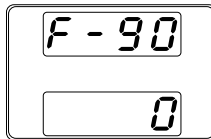

3. Rotate the Voltage knob to change the F setting.

Range F-90~ F-94

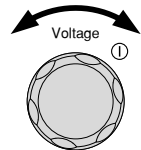

4. Use the Current knob to set the parameter for the chosen F setting.

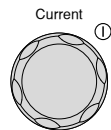

- 5. Press the Voltage knob to save the configuration setting. ConF will be displayed when successful.

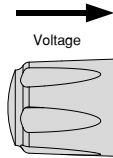

Exit

Cycle the power to save and exit the configuration settings.

A ANALOG CONTROL

The Analog Control chapter describes how to control the voltage or current output using an external voltage or resistance, monitor the voltage or current output as well as remotely turning off the output or shutting down the power supply.

Analog Remote Control Overview	84
Analog Control Connector Overview	85
External Voltage Control of Voltage Output	88
External Voltage Control of Current Output	90
External Resistance Control of Voltage Output	93
External Resistance Control of Current Output	95
External Control of Output	97
External control of Shutdown	99
External control of Alarm clear	100
Remote Monitoring.....	102
External Voltage and Current Monitoring	102
External Operation and Status Monitoring.....	104

Analog Remote Control Overview

The PFR-100 power supply series have a number of analog control options. The Analog Control connectors are used to control output voltage and current using external voltage or resistance. The power supply output can also be controlled using external switches.

Analog control connector overview → from page 85

External voltage control of voltage output → from page 88

External voltage control of current output → from page 90

External resistance control of voltage output → from page 93

External resistance control of current output → from page 95

External control of output → from page 97

External control of the shutdown → from page 99

External control of Alarm clear → from page 100

Analog Control Connector Overview

Overview The Analog Control Connector(J1) is a 20pin connector that can be used with the plug for wiring connection. The connector is used for all analog remote control. The pins used determine what remote control mode is used.

Pin Assignment

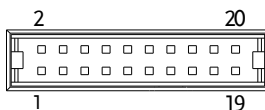

Pin name	Pin number	Description
Status COM	1	This is the common line for the status signal pins 2 to 6.
Alarm Status	2	On when a protection function (OVP, HW_OVP, OCP, OHP, AC_FAIL or OPP) has been activated or when an output shutdown signal is being applied (open-collector photocoupler output). ¹
CV Status	3	This line is On when the PFR-100 is in CV mode (open-collector photocoupler output). ¹
PWR OFF Status	4	Outputs a low level signal when power is turned off. (open-collector photocoupler output). ¹
CC Status	5	This line is On when the PFR-100 is in CC mode (open-collector photocoupler output). ¹
OUT ON Status	6	On when the output is on (open-collector photocoupler output). ¹
N.C.	7	Not connected.
N.C.	8	Not connected.
N.C.	9	Not connected.
N.C.	10	Not connected.

Alarm Clear	11 Alarm clear line. Alarms are cleared when a low TTL signal is applied.
Shutdown	12 Output shutdown control line. The output is turned off when a low TTL signal is applied.
A COM	13 This is the common line for external signal pins 11, 12, 14, 16, 18, 19, and 20. During remote sensing, this is the negative electrode (-S) of sensing input. When remote sensing is not being performed, this is connected to the negative output.
OUT ON/OFF CONT	14 Output on/off line. On when set to a low TTL signal, Off when set to a high TTL signal. (F-94: 1) On when set to a high TTL signal, Off when set to a low TTL level signal. (F-94: 0)
A COM	15 This is the common line for external signal pins 11, 12, 14, 16, 18, 19, and 20. During remote sensing, this is the negative electrode (-S) of sensing input. When remote sensing is not being performed, this is connected to the negative output.
EXT-V/R CV CONT	16 This line uses an external voltage or resistance to control the output voltage. External voltage control (F-90: 1); External resistor control (F-90: 2, F-90:3) 0 to 10 V or 0 to 10k ; 0 % to 100 % of the rated output voltage.
A COM	17 This is the common line for external signal pins 11, 12, 14, 16, 18, 19, and 20. During remote sensing, this is the negative electrode (-S) of sensing input. When remote sensing is not being performed, this is connected to the negative output.

EXT-V/R CC CONT	18 This line uses an external voltage or resistance to control the output current. External voltage control (F-91: 1); External resistor control (F-91: 2, F-91:3) 0 to 10 V or 0 to 10k ; 0 % to 100 % of the rated output current.
I MON	19 Output current monitor. 0 % to 100 % of the rated output current is generated as a voltage between 0 V and 10 V.
V MON	20 Output voltage monitor. 0 % to 100 % of the rated output voltage is generated as a voltage between 0 V and 10 V.

¹ Open collector output: Maximum voltage of 30 V and maximum current of 8 mA. The common line for the status pins is floating (isolated voltage of 60 V or less), it is isolated from the control circuit.

External Voltage Control of Voltage Output

Background External voltage control of the voltage output is accomplished using the analog control connector on the rear panel. A voltage of 0~10V is used to control the full scale voltage of the instrument, where:

$$\text{Output voltage} = \text{full scale voltage} \times (\text{external voltage}/10)$$

Connection When connecting the external voltage source to the analog connector, use shielded or twisted paired wiring.

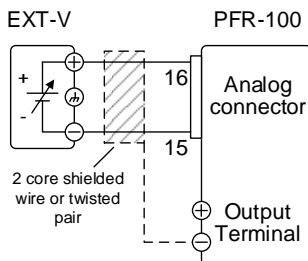

Pin16 → EXT-V (+)

Pin15 → EXT-V (-)

Wire shield → negative (-) output terminal

Connection- alt. shielding

If the wire shield needs to be grounded at the voltage source (EXT-V), then the shield cannot also be grounded at the negative (-) terminal output of the PFR-100 power supply. This would short the output.

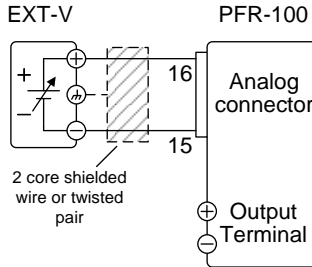

Pin16 → EXT-V (+)

Pin15 → EXT-V (-)

Wire shield → EXT-V ground (GND)

Panel operation

6. Connect the external voltage according to the connection diagrams above.

7. Set the F-90 power on configuration setting to 1 (CV control - Ext voltage). Page 81

Be sure to cycle the power after the power on configuration has been set.

8. Press the Function key and confirm the new configuration settings (F-90=1). 

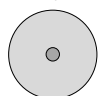
9. Press the Output key. The voltage can now be controlled with the External voltage. 



Note

The input impedance for external voltage control is a high impedance OPA input.

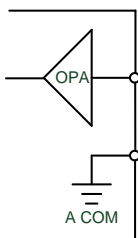

Use a stable voltage supply for the external voltage control.



Note

CV and CC Slew Rate Priority are disabled for V-I mode (F-03) when using external voltage control. See the Normal Function Settings on page 71.



CAUTION

Ensure no more than 10.5 volts are input into the external voltage input.

Ensure the voltage polarity is correct when connecting the external voltage.

External Voltage Control of Current Output

Background

External voltage control of the current output is accomplished using the analog control connector on the rear panel. A voltage of 0~10V is used to control the full scale current of the instrument, where:

$$\text{Output current} = \text{full scale current} \times (\text{external voltage}/10)$$

Connection

When connecting the external voltage source to the analog connector, use shielded or twisted paired wiring.

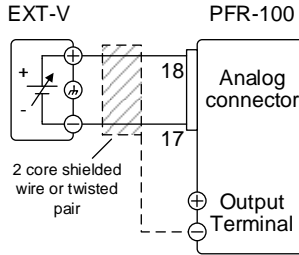

Pin18 → EXT-V (+)

Pin17 → EXT-V (-)

Wire shield → negative (-) output terminal

Connection- alt. shielding

If the wire shield needs to be grounded at the voltage source (EXT-V), then the shield cannot also be grounded at the negative (-) terminal output of the PFR-100 power supply. This would short the output.

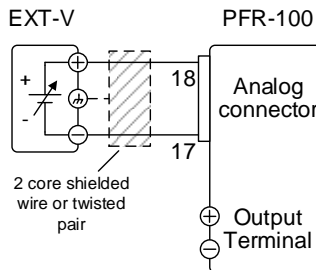

Pin18 → EXT-V (+)

Pin17 → EXT-V (-)

Wire shield → EXT-V ground (GND)

Steps

1. Connect the external voltage according to the connection diagrams above.

2. Set the F-91 power on configuration setting to 1 (CC control – Ext voltage). Be sure to cycle the power after the power on configuration has been set. Page 81

3. Press the Function key and confirm the new configuration settings (F-91=1). Function 

4. Press the Output key. The current can now be controlled with the External voltage. Output 

 **Note**

The input impedance for external voltage control is a high impedance OPA input.

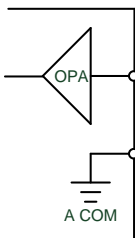

Use a stable voltage supply for the external voltage control.

 **Note**

CV and CC Slew Rate Priority are disabled for V-I mode (F-03) when using external voltage control. See the normal function settings on page 71.

 **CAUTION**

Ensure no more than 10.5 volts are input into the external voltage input.

Ensure the voltage polarity is correct when connecting the external voltage.

External Resistance Control of Voltage Output

Background

External resistance control of the voltage output is accomplished using the analog connector on the rear panel. A resistance of $0\Omega\sim 10k\Omega$ is used to control the full scale voltage of the instrument.

The output voltage (0 to full scale) can be controlled with the external resistance going up (Ext-R \swarrow) $0\Omega\sim 10k\Omega$ ($10k\Omega = V_{o,max}$) or down (Ext-R \searrow) $10k\Omega\sim 0\Omega$ ($10k\Omega = 0$).

For $0\Omega\sim 10k\Omega$: Output voltage = full scale voltage \times (external resistance/10)

For $10k\Omega\sim 0\Omega$: Output voltage = full scale voltage \times ([10-external resistance]/10)



The Ext-R \searrow configuration is recommended for safety reasons. In the event that the cables become accidentally disconnected, the voltage output will drop to zero. Under similar circumstances using Ext-R \swarrow , an unexpected high voltage would be output.

If switches are used to switch between fixed resistances, use switches that avoid creating open circuits. Use short-circuit or continuous resistance switches.

Connection

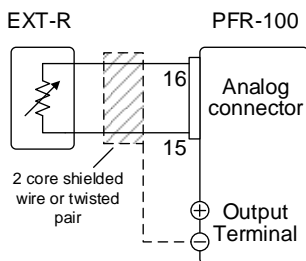

Pin16 → EXT-R

Pin15 → EXT-R

Wire shield → negative (-) output terminal

Steps

1. Connect the external resistance according to the connection diagrams above.
2. Set the F-90 (CV Control) configuration settings to 2 for Ext-R ∇ or 3 for Ext-R \triangle .
 Be sure to cycle the power after the power on configuration has been set.
 Page 81
3. Press the Function key and confirm the new configuration settings (F-90=2 or 3).

Function

4. Press the Output key. The voltage can now be controlled with the External resistance.

Output

 Note

Ensure the resistor(s) and cables used exceed the isolation voltage of the power supply. For example: insulation tubes with a withstand voltage higher than the power supply can be used.

When choosing an external resistor ensure the resistor can withstand a high degree of heat.



Note

CV and CC Slew Rate Priority are disabled for V-I mode (F-03) when using external resistance control. See the normal function settings on page 70.

External Resistance Control of Current Output

Background

External resistance control of the current output is accomplished using the analog connector on the rear panel. A resistance of $0\Omega\sim 10k\Omega$ is used to control the full scale current of the instrument.

The output current (0 to full scale) can be controlled with the external resistance going up (Ext-R \swarrow) $0\Omega\sim 10k\Omega$ ($10k\Omega = I_{o,max}$) or down (Ext-R \searrow) $10k\Omega\sim 0\Omega$ ($10k\Omega = 0$).

For $0\Omega\sim 10k\Omega$: Output current = full scale current \times (external resistance/10)

For $10k\Omega\sim 0\Omega$: Output current = full scale current \times ([10-external resistance]/10)



Note

The Ext-R \searrow configuration is recommended for safety reasons. In the event that the cables become accidentally disconnected, the current output will drop to zero. Under similar circumstances using Ext-R \swarrow , an unexpected high current would be output.

If switches are used to switch between fixed resistances, use switches that avoid creating open circuits. Use short-circuit or continuous resistance switches.

Connection

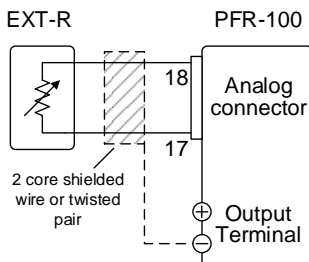

Pin18 → EXT-R

Pin17 → EXT-R

Wire shield → negative (-) output terminal

Steps

1. Connect the external resistance according to the connection diagrams above.
2. Set the F-91 (CC Control) Page 81
configuration settings to 2 for Ext-R or 3 for Ext-R .
Be sure to cycle the power after the power on configuration has been set.
3. Press the Function key and confirm the new configuration settings (F-91 = 2 or 3).
4. Press the Output key. The current can now be controlled with the External resistance.

Note

Ensure the resistor(s) and cables used exceed the isolation voltage of the power supply. For example: insulation tubes with a withstand voltage higher than the power supply can be used.

When choosing an external resistor ensure the resistor can withstand a high degree of heat.

External Control of Output

Background

The output can be turned on or off externally using a switch. The analog control connector can be set to turn the output on from a high or low signal. The voltage across pins 14 and 13 are internally pulled to +5V $\pm 5\%$ @ 500uA with 10k Ω pull-up resistor. A short (closed switch) produces a low signal.

When set to High = On, the output is turned on when the pins 14-13 are open.

When Low = On, the output is turned on when pins 14-13 are shorted.

Connection

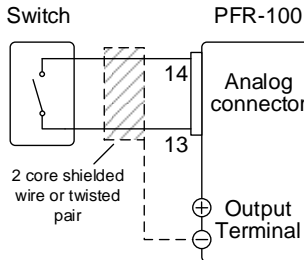

Pin14 → Switch

Pin13 → Switch

Wire shield → negative (-) output terminal

Steps

1. Connect the external switch according to the connection diagrams above.
Set F-94 (External output logic) in the power on configuration settings to 0 (High = On) or 1 (Low = On).
Be sure to cycle the power after setting the power on configuration Page 81 settings.

2. Press the Function key and confirm the new configuration setting. (F-94= 0 or 1) Function 
3. The switch is now ready to set the output on or off.



Note

When using a switch over long distances, please use a switch relay to extend the line from the coil side of the relay.

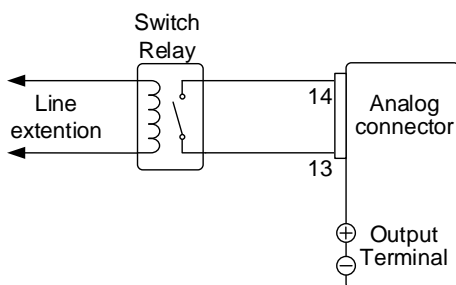

If a single switch control is to be used for multiple units, please isolate each instrument. This can be achieved by using a relay.



Warning

Ensure the cables used and the switch exceed the isolation voltage of the power supply. For example: insulation tubes with a withstand voltage higher than the power supply can be used.



Note

Messages: If F-94 = 0 (High = on) and pin 14 is low (0) "MSG 001" will be displayed on the display.

If F-94 = 1 (Low = on) and pin 14 is high (1) "MSG 002" will be displayed on the display.

Output off (High=on)



Output off (Low=on)



Note

Output ON/OFF Delay Time (F-01, F-02) are disabled when the output is set to external control. See the normal function settings on 70 for details.

External control of Shutdown

Background

The output of the power supplies can be configured to shut down via an external switch. The voltage across pins 12 and 13 are internally pulled to +5V \pm 5% @ 500uA with 10k Ω pull-up resistor. The output is turned off when a low TTL level signal is applied.

Connection

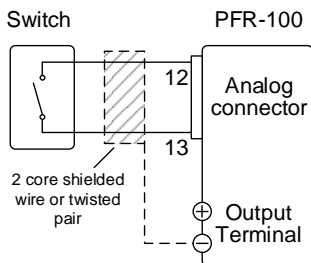

Pin12 → Switch

Pin13 → Switch

Wire shield → negative (-) output terminal

- Steps
1. Connect the external switches according to the connection diagrams above.
 2. The switch will now shut down the power supply when shorted.



Note

When using a switch over long distances, please use a switch relay to extend the line from the coil side of the relay.

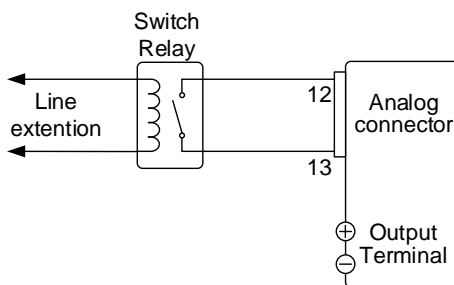

If a single switch control is to be used for multiple units, please isolate each instrument. This can be achieved by using a relay.



Warning

Ensure the cables and switch used exceed the isolation voltage of the power supply. For example: insulation tubes with a withstand voltage higher than the power supply can be used.

External control of Alarm clear

Background

The output of the power supplies can be configured to clear alarm signal via an external switch. The voltage across pins 11 and 13 are internally pulled to +5V \pm 5% @ 500uA with 10k Ω pull-up resistor. The output is turned off when a low TTL level signal is applied.

Connection

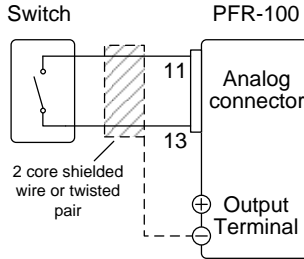

Pin11 → Switch

Pin13 → Switch

Wire shield → negative (-) output terminal

Steps

1. Connect the external switches according to the connection diagrams above.
2. The switch will now clear alarm signal when shorted.



Note

When using a switch over long distances, please use a switch relay to extend the line from the coil side of the relay.

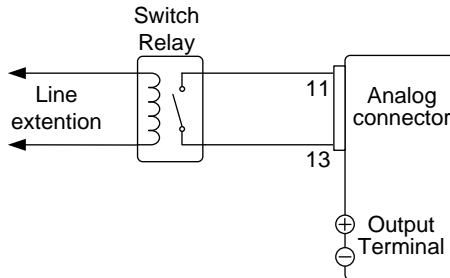

If a single switch control is to be used for multiple units, please isolate each instrument. This can be achieved by using a relay.



Warning

Ensure the cables and switch used exceed the isolation voltage of the power supply. For example: insulation tubes with a withstand voltage higher than the power supply can be used.

Remote Monitoring

The PFR-100 power supplies have remote monitoring support for current and voltage output. They also support monitoring of operation and alarm status.

External monitoring of output voltage and current → from page 102

External monitoring of operation mode and alarm status → from page 104

External Voltage and Current Monitoring

Background

The analog connector is used to monitor the current (IMON) or voltage (VMON) output.

An output of 0~10V represents the voltage or current output of 0~ rated current/voltage output.

$IMON = (\text{current output} / \text{full scale}) \times 10.$

$VMON = (\text{voltage output} / \text{full scale}) \times 10.$

External voltage and current monitoring doesn't need to be enabled in the configuration settings.

VMON Connection

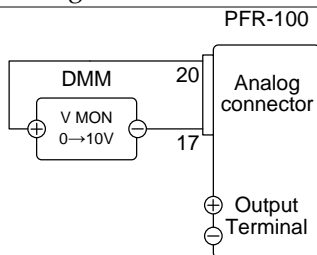

Pin17 → Neg (-)

Pin20 → Pos (+)

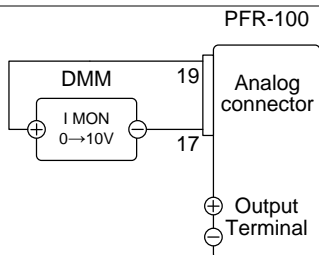
IMON
Connection

Pin17 → Neg (-)

Pin19 → Pos (+)



Note

Maximum current is 5mA. Ensure the sensing circuit has an input impedance greater than 1M Ω .

The monitor outputs are strictly DC and should not be used to monitor analog components such as transient voltage response or ripple etc.



CAUTION

Ensure IMON (pin 19) and VMON (pin 20) are not shorted together. This may cause damage to the unit.

External Operation and Status Monitoring

Background The analog connector can also be used to monitor the status operation and alarm status of the instrument.

The pins are isolated from the power supply internal circuitry by photo couplers. Status Com (Pin 1) is a photo coupler emitter output, whilst pins 2~6 are photo coupler collector outputs.

A maximum of 30V and 8mA can be applied to each pin.

Pinout	Name and Pin	Description
	Status COM 1	This is the common line for the status signal pins 2 to 6.
	Alarm Status 2	On when a protection function (OVP, HW_OVP, OCP, OHP, AC_FAIL or OPP) has been activated or when an output shutdown signal is being applied (open-collector photocoupler output). ¹
	CV Status 3	This line is On when the PFR-100 is in CV mode (open-collector photocoupler output). ¹
	PWR OFF Status 4	Outputs a low level signal when power is turned off. (open-collector photocoupler output). ¹
	CC Status 5	This line is On when the PFR-100 is in CC mode (open-collector photocoupler output). ¹

OUT ON Status 6 On when the output is on (open-collector photocoupler output).¹

Schematic

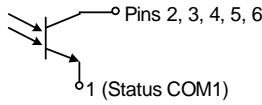

Timing diagrams

Below are 4 example timing diagrams covering a number of scenarios. Note that pins 2~6 are all active low.

CV MODE:
Output turned on

The diagram below shows the timing diagram when the output is turned on when the PFR-100 is set to CV mode.

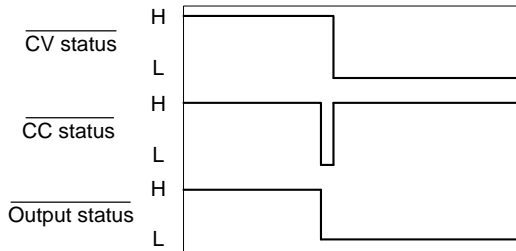

CV MODE:
Output turned off

The diagram below shows the output status lines when the output is turned off in CV mode.

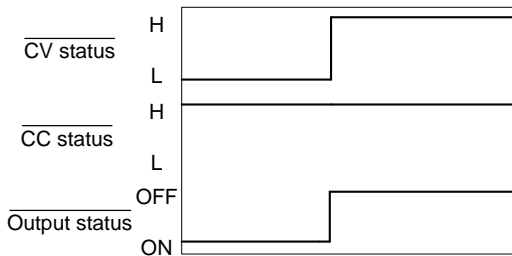

CC MODE: The diagram below shows the timing diagram when the output is turned on when the PFR-100 is set to CC mode.
Output turned on

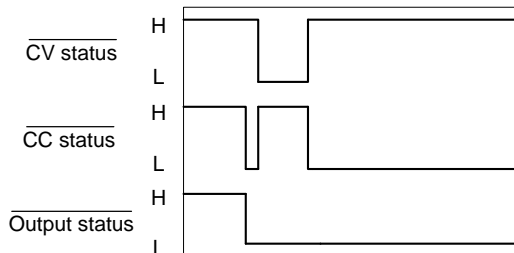

CC MODE: The diagram below shows the output status lines when the output is turned off in CC mode.
Output turned off

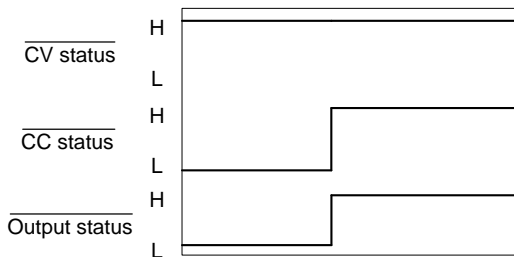

C

COMMUNICATION

INTERFACE

This chapter describes basic configuration of IEEE488.2 based remote control. For a command list, refer to the programming manual, downloadable from GW Instek website, www.gwinstek.com

Interface Configuration	108
USB Remote Interface	108
Configuration.....	108
USB CDC Function Check.....	109
GPIB Remote Interface.....	111
Configuration.....	111
GPIB Function Check	112
UART Remote Interface	116
Configure UART	116
UART Function Check.....	119
Multiple Unit Connection	120
Multi-Drop mode	120
Multiple units Function Check.....	123
Configure Ethernet Connection.....	125
Web Server Configuration	125
Web Server Remote Control Function Check.....	126
Sockets Server Configuration	128
Socket Server Function Check	129

Interface Configuration

USB Remote Interface



Note

When using the USB Remote Interface, The USB port on the front panel will become disabled and fail to be used.

Configuration

USB Configuration	PC side connector	Type A, host
	PFR-100 side connector	Rear panel Type B, slave
	Speed	1.1 (full speed)
	USB Class	CDC (communications device class)

Steps

1. Connect the USB cable to the rear panel USB B port.

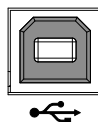

2. Set the Function setting F-29 (Interface port). F-29 = 3 (USB-CDC)

Page 79

3. Check to see that the USB is detected by PFR-100. The F-21 setting indicates the rear USB port

F-21 = 0 Indicates the rear USB port is not detected.
 F-21 = 1 Indicates the rear USB port is available.

4. The RMT indicator will turn on when a remote connection has been established.



RMT indicator

USB CDC Function Check

Functionality
check

Invoke a terminal application such as Realterm.

To check the COM port No., see the Device Manager in the PC

Run this query command via the terminal application after the instrument has been configured for USB remote control.

*idn?

This should return the Manufacturer, Model number, Serial number, and Firmware version in the following format.

GW-INSTEK,PFR-100L,TW1234567,01.01.12345678

Manufacturer: GW-INSTEK

Model number : PFR-100L

Serial number : TW1234567

Firmware version : 01.01.12345678



Note

For further details, please see the programming manual, available on the GW Instek web site @ www.gwinstek.com.

GPIB Remote Interface

Configuration

To use GPIB, the optional GPIB option (GW Instek part number: PFR-GL) must be installed. This is a factory installed option and cannot be installed by the end-user. Only one GPIB address can be used at a time.

- Configure GPIB
1. Ensure the PFR-100 is off before proceeding.
 2. Connect the GPIB cable (GW Instek part number: GTL-258) from a GPIB controller to the GPIB port on the PFR-100.
 3. Turn the PFR-100 on.
 4. Press the Function key to enter the Page 79
Normal configuration settings.
 5. Set the following GPIB settings.

F-29 = 4	Enable the GPIB port
F-23 = 0~30	Set the GPIB address (0~30)
 6. Check to see that the GPIB option is detected by the PFR-100. The F-25 setting indicates the GPIB port status.

F-25 = 0	Indicates that the GPIB port is not detected.
F-25 = 1	Indicates that the GPIB port is available.

- The RMT indicator will turn on when a remote connection has been established.



RMT indicator

- GPIB constraints
- Maximum 15 devices altogether, 20m cable length, 2m between each device
 - Unique address assigned to each device
 - At least 2/3 of the devices turned On
 - No loop or parallel connection

GPIB Function Check

Background To test the GPIB functionality, National Instruments Measurement and Automation Explorer can be used. This program is available on the NI website, www.ni.com, via a search for the VISA Run-time Engine page, or “downloads” at the following URL, <http://www.ni.com/visa/>

Requirements Operating System: Windows XP, 7, 8

- Functionality check**
1. Start the NI Measurement and Automation Explorer (MAX) program. Using Windows, press:

Start>All Programs>National Instruments>Measurement & Automation



2. From the Configuration panel access;
My System>Devices and Interfaces>GPIB
3. Press *Scan for Instruments*.

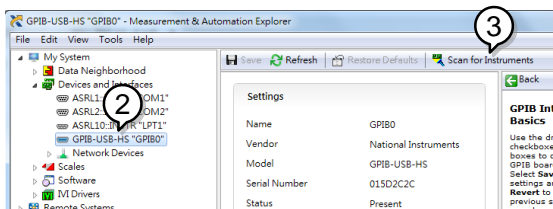

4. Select the device (GPIB address of PFR-100) that now appears in the *System>Devices and Interfaces > GPIB-USB-HS "GPIBX"* node.
5. Click on the *VISA Properties* tab on the bottom.
6. Click *Open Visa Test Panel*.

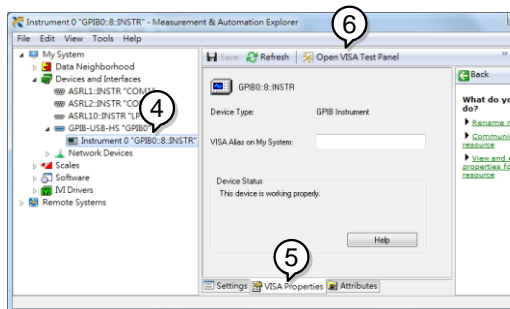

7. Click on *Configuration*.
8. Click on the *GPIB Settings* tab and confirm that the GPIB settings are correct.

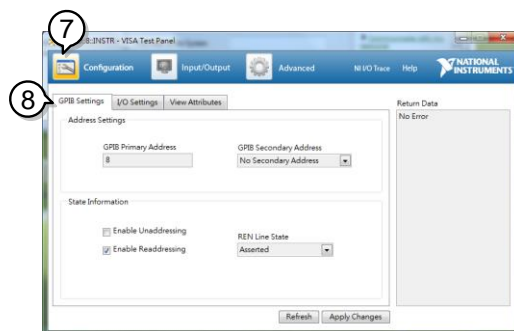

9. Click on the *I/O Settings* tab.
10. Make sure the *Enable Termination Character* check box is checked, and the terminal character is \n (Value: xA).
11. Click *Apply Changes*.

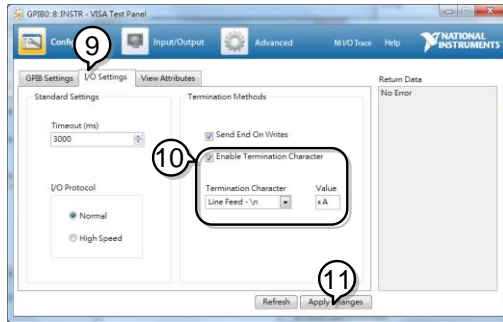

12. Click on *Input/Output*.

13. Click on the *Basic I/O* tab.

14. Enter *IDN? in the *Select or Enter Command* drop down box.

15. Click *Query*.

16. The *IDN? query will return the Manufacturer, model name, serial number and firmware version in the dialog box.

GW-INSTEK,PFR-
100L,TW1234567,01.01.12345678

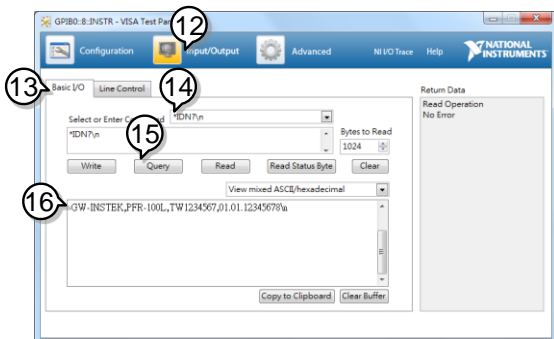



Note

For further details, please see the programming manual, available on the GW Instek web site @ www.gwinstek.com.

UART Remote Interface

Configure UART

Overview

The PFR-100 uses the IN & OUT ports for UART communication coupled with RS232 (GW Instek Part number: PSU-232) or RS485 adapters (GW Instek part number: PSU-485).

The pin outs for the adapters are shown below.

RS232 cable with DB9 & RJ-45 shielded connectors from PSU-232 connection kit	DB-9 Connector		Remote IN Port		Remarks
	Pin No.	Name	Pin No.	Name	
	Housing	Shield	Housing	Shield	
	2	RX	7	TX	Twisted pair
	3	TX	8	RX	
	5	SG	1	SG	

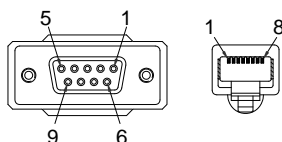

RS485 cable with DB9 & RJ-45 shielded connectors from PSU-485 connection kit

DB-9 Connector		Remote IN Port		Remarks
Pin No.	Name	Pin No.	Name	
Housing	Shield	Housing	Shield	
9	TXD -	6	RXD -	Twisted pair
8	TXD +	3	RXD +	
1	SG	1	SG	
5	RXD -	5	TXD -	Twisted pair
4	RXD +	4	TXD +	

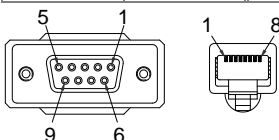

Steps

1. Connect the RS232 serial cable (include in the PSU-232 connection kit) or RS485 serial cable (include in the PSU-485 connection kit) to the Remote IN port on the real panel.

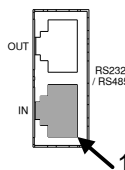

Connect the other end of the cable to the PC.

2. Press the Function key to enter the Page 79 Normal configuration settings.

Set the following UART settings:

F-29 = 1 or 2	Interface port: 1 = RS232 or 2 = RS485
F-71 = 0 ~ 7	Set the baud rate: 0=1200, 1=2400, 2=4800, 3=9600, 4=19200, 5=38400, 6=57600, 7=115200
F-72 = 0 or 1	Data bits: 0=7 or 1=8

F-73 = 0 ~2	Parity: 0 = none, 1 = odd, 2 = even
F-74 = 0 or 1	Stop bits: 0 = 1, 1 = 2
F-75 = 0	TCP: 0 = SCPI
F-76 = 0~30	UART address for multi-unit remote connection.
F-77 = 0~3	Multi-Drop control 0 = Disable, 1 = Master, 2 = Slave, 3 = Display Information
F-78 = 0~30	Multi-Drop status display Displayed parameter: AA-S AA: 0~30 (Address), S: 0~1 (Off-line/On-line status).

- The RMT indicator will turn on when a remote connection has been established.



RMT indicator

UART Function Check

Functionality check Invoke a terminal application such as Realterm.
To check the COM port No, see the Device Manager in the PC.

Run this query command via the terminal application after the instrument has been configured for either RS232 or RS485 remote control.

*idn?

This should return the Manufacturer, Model number, Serial number, and Firmware version in the following format:

GW-INSTEK,PFR-100L,TW1234567,01.01.12345678

Manufacturer: GW-INSTEK

Model number : PFR-100L

Serial number : TW1234567

Firmware version : 01.01.12345678



Note

For further details, please see the programming manual, available on the GW Instek web site @ www.gwinstek.com.

Multiple Unit Connection

The PFR-100 power supplies can have up to 31 units daisy-chained together using the 8 pin connectors (IN OUT ports) on the rear panel. The first unit (master) in the chain is remotely connected to a PC using USB, GPIB or LAN (Multi-Drop mode). Each subsequent unit (slave) is daisy-chained to the next using a RS485 local bus. The OUT port on the last terminal must be terminated by the end terminal connector.

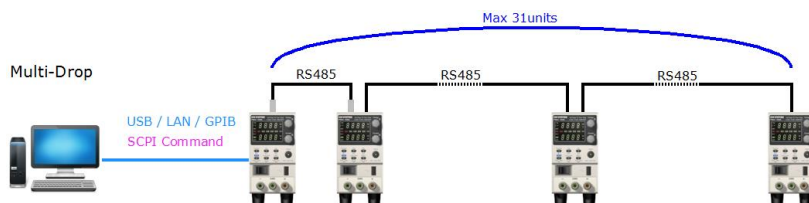

There is a mode for controlling multiple units. This mode allows the user to enter the SCPI commands developed for the instrument (Multi-Drop mode). In this mode, only the Multi-Drop parameters have to be specified. Each unit is assigned a unique PC address and can then be individually controlled from the host PC.

Multi-Drop mode

- | | |
|-----------|---|
| Operation | <ol style="list-style-type: none">1. All units must be powered down before starting the Multi-Drop mode configuration.2. Connect the first unit's LAN, USB or GPIB port to a PC.3. Connect the OUT port on the first unit to the IN port of the second unit using the master serial link cable (gray plug) supplied in the PSU-232 or PSU-485 connection kit. |
|-----------|---|

4. Connect all the remaining units between the OUT port and the IN port with the slave serial link cable (black plug) supplied in the PSU-232 or PSU-485 connection kit until all the desired units have been daisy-chained together.

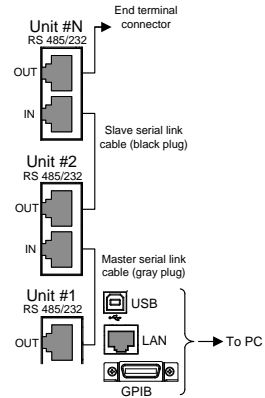

5. Terminate the OUT port of the last unit with the end terminal connector included in the PSU-232 or PSU-485 connection kit.
6. Power up all slave units.
7. Set the addresses of all slave units using the F-76 parameter.
- Set the address of the master unit. It must be a unique address identifier.
- F-76 = 00~30
8. Set the Multi-Drop setting parameter (F-77) to Slave for all slave units.
- Set the Multi-Drop setting to slave.
- F-77 = 2
9. Power up the master unit.
10. Set the addresses of the master units using the F-76 parameter.
- Set the address of the unit. It must be a unique address identifier.
- F-76 = 0 ~ 30

11. You can check the slaves' addresses by using the F-77 parameter on the master unit.

F-77 = 3 Display on each slave units the configured address. This can show if identical addresses have been assigned individually to each slave units.

12. Set the Multi-Drop setting parameter (F-77) to Master.

F-77 = 1 Set the Multi-Drop setting to master.

13. You can display the status of each slave unit by using the F-78 parameter.

F-78 = 0~30 Displayed parameter: AA-S
AA: 0~30 (Address),
S: 0~1 (Off-line/On-line status).

14. Multiple units can now be operated using SCPI commands. See the programming manual or see the function check below for usage details.

Slave serial link cable with RJ-45 shielded connectors from PSU-232 or PSU-485 connection kit	RS-485 slave serial link pin assignment			
	8 Pin Connector (IN)		8 Pin Connector (OUT)	
	Pin No.	Name	Pin No.	Name
	Housing	Shield	Housing	Shield
	1	SG	1	SG
	6	TXD -	6	TXD -
	3	TXD +	3	TXD +
Master serial link cable with RJ-45 shielded connectors from	RS-485 master serial link pin assignment			
	8 Pin Connector (IN)		8 Pin Connector (OUT)	
	Pin No.	Name	Pin No.	Name
	Housing	Shield	Housing	Shield
	1	SG	1	SG

PSU-232 or PSU-485 connection kit	6	TXD -	5	RXD -
	3	TXD +	4	RXD +
	5	RXD -	6	TXD -
	4	RXD +	3	TXD +

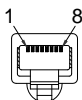

Multiple units Function Check

Functionality check	Invoke a terminal application such as Realterm. To check the COM port No, see the Device Manager in the PC.
---------------------	--

Multi-Drop mode	When using the Multi-Drop mode, the entire SCPI command list developed for the PFR-100 can be used. Each unit can be individually controlled after a slave unit has been selected. For this function check, we will assume that the master unit is assigned to address 0, while a slave is assigned address 5.
-----------------	--

Run this query command via the terminal application after the instruments have been configured for multi-unit control with Multi-Drop mode. See page 120.

```
INST:SEL 0
```

```
*IDN?
```

```
GW-INSTEK,PFR-100L,TW1234567,  
01.01.12345678
```

Selects the unit with address 0 and returns its identity string.

INST:SEL 5

*IDN?

GW-INSTEK,PFR-100M,TW1234567,
01.01.12345678

Selects the unit with address 5 and returns its identity string.

INST:SEL 6

Selects the unit with address 6 (not configured in our example). An error is displayed on the master front panel.

SYST:ERR?

Settings conflict

Query the system errors. "Settings conflict" is returned.

INST:STAT?

33,0

Returns the active units and master unit in the bus.

33=0b100001

The units at address 0 and address 5 are on-line.

0

Master device's address is 0.



Note

For further details, please see the programming manual, available on the GW Instek web site @ www.gwinstek.com.

Configure Ethernet Connection

The Ethernet interface can be configured for a number of different applications. Ethernet can be configured for basic remote control or monitoring using a web server or it can be configured as a socket server.

The PFR-100 series supports both DHCP connections so the instrument can be automatically connected to an existing network or alternatively, network settings can be manually configured.

Ethernet configuration	For details on how to configure the Ethernet settings, please see the configuration chapter on page 75.	
Parameters	DHCP Enable/Disable	MAC Address (display only)
	Subnet Mask	IP Address
	DNS Address	Gateway
	Web Enter Password	Web Password Enable/Disable

Web Server Configuration

Configuration This configuration example will configure the PFR-100 as a web server and use DHCP to automatically assign an IP address to the PFR-100.

1. Connect an Ethernet cable from the network to the rear panel Ethernet port.

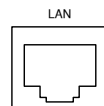

2. Press the Function key to enter the Page 79 Normal configuration settings.

Set the following LAN settings:

F-29 = 6	Interface port select & Turn LAN(Web) on
F-37 = 1	Enable DHCP
F-60 = 0 or 1	Set to 0 to disable web password, set to 1 to enable web password.
F-61 = 0000 ~9999	Set the web password

3. The LAN indicator will turn on when a network cable is plugged in.



Note

It may be necessary to cycle the power or refresh the web browser to connect to a network.

Web Server Remote Control Function Check

Functionality
check

Enter the IP address of the power supply in a web browser after the instrument has been configured as a web server.

The web server allows you to monitor the function settings of the PFR-100.

You can check the IP address by checking F-39 to F-42.

F-39 = AAA	IP Address part 1 of 4
F-40 = BBB	IP Address part 2 of 4

F-41 = CCC IP Address part 3 of 4
 F-42 = DDD IP Address part 4 of 4

http:// AAA.BBB.CCC.DDD

The web browser interface appears.

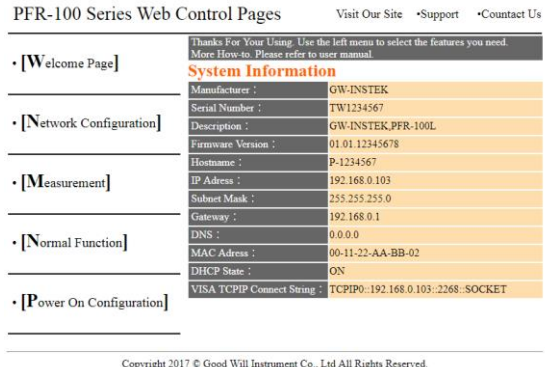

The web browser interface allows you to access the following:

- Network configuration settings
- Measurement setting
- Normal Function setting
- Power On Configuration setting

Sockets Server Configuration

Configuration This configuration example will configure the PFR-100 socket server.

The following configuration settings will manually assign the PFR-100 an IP address and enable the socket server. The socket server port number is fixed at 2268.

1. Connect an Ethernet cable from the network to the rear panel Ethernet port.

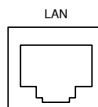

2. Press the Function key to enter the Page 79 Normal configuration settings.

Set the following LAN settings:

F-29 = 5	Interface port select & Turn LAN(Socket) on
F-37 = 0	Disable DHCP
F-39 = 172	IP Address part 1 of 4
F-40 = 16	IP Address part 2 of 4
F-41 = 5	IP Address part 3 of 4
F-42 = 133	IP Address part 4 of 4
F-43 = 255	Subnet Mask part 1 of 4
F-44 = 255	Subnet Mask part 2 of 4
F-45 = 128	Subnet Mask part 3 of 4
F-46 = 0	Subnet Mask part 4 of 4
F-47 = 172	Gateway part 1 of 4
F-48 = 16	Gateway part 2 of 4
F-49 = 21	Gateway part 3 of 4
F-50 = 101	Gateway part 4 of 4

Socket Server Function Check

Background To test the socket server functionality, National Instruments Measurement and Automation Explorer can be used. This program is available on the NI website, www.ni.com, via a search for the VISA Run-time Engine page, or “downloads” at the following URL, <http://www.ni.com/visa/>

Requirements Operating System: Windows XP, 7, 8

Functionality check 1. Start the NI Measurement and Automation Explorer (MAX) program. Using Windows, press:

Start>All Programs>National Instruments>Measurement & Automation



2. From the Configuration panel access;

My System>Devices and Interfaces>Network Devices

3. Press *Add New Network Device>Visa TCP/IP Resource...*

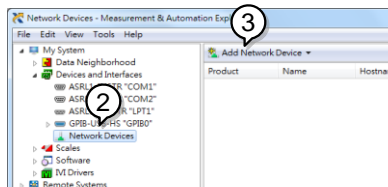

4. Select *Manual Entry of Raw Socket* from the popup window.

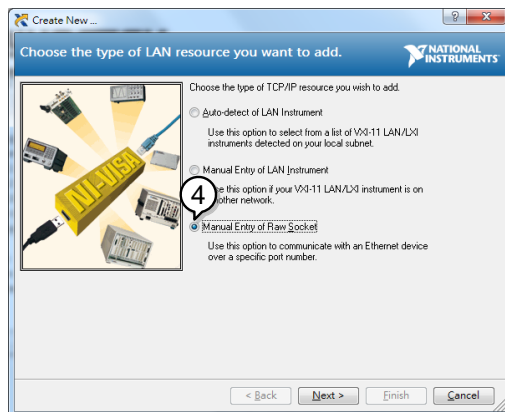

5. Enter the IP address and the port number of the PFR-100. The port number is fixed at 2268.
6. Click the Validate button.
7. A popup will appear if a connection is successfully established.
8. Click Next.

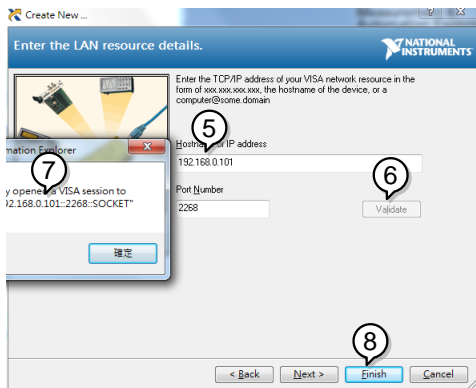

9. Next configure the Alias (name) of the PFR-100 connection. In this example the Alias is: PFR_DC1

10. Click finish.

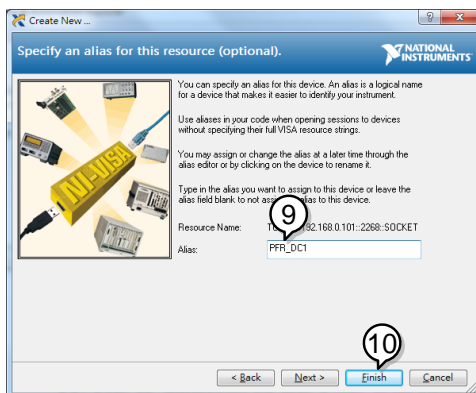

11. The IP address of the PFR-100 will now appear under Network Devices in the configuration panel. Select this icon now.

12. Click *Open VISA Test Panel*.

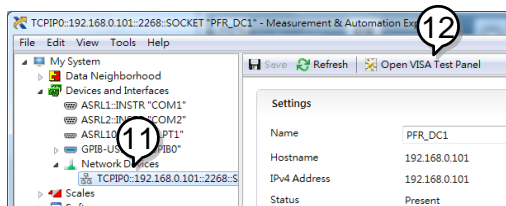

13. Click the *Configuration* icon,
14. Click on *I/O Settings*.
15. Make sure the *Enable Termination Character* check box is checked, and the terminal character is \n (Value: xA).
16. Click *Apply Changes*.

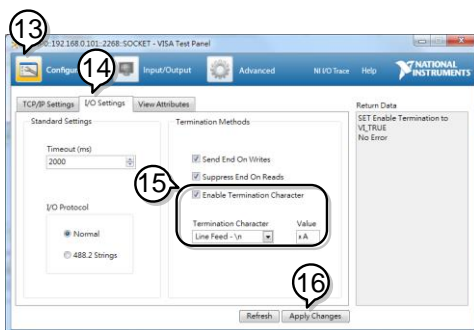

17. Click the *Input/Output* icon.
18. Enter **IDN?* in the *Select or Enter Command* dialog box if it is not already.
19. Click the *Query* button.
20. The **IDN?* query will return the Manufacturer, model name, serial number and firmware version in the dialog box.

GW-INSTEK,PFR-100L,TW1234567,01.01.12345678

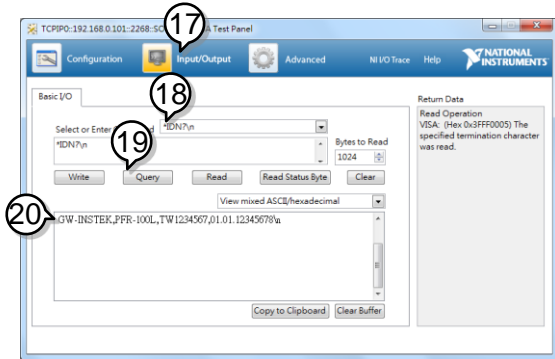

 **Note**

For further details, please see the programming manual, available on the GW Instek web site @ www.gwinstek.com.

FAQ

-
- How often should the power supply be calibrated?
 - The OVP voltage is triggered earlier than expected.
 - Can I combine more than 1 cable together for the output wiring?
 - The accuracy does not match the specification.

How often should the power supply be calibrated?

The PFR-100 should be calibrated by an authorized service center at least every 2 years. For details regarding calibration, see your local dealer or GWInstek at www.gwinstek.com/ / marketing@goodwill.com.tw.

The OVP voltage is triggered earlier than expected.

When setting the OVP voltage, take into account the voltage drop from the load cables. As the OVP level is set from the output terminals and not the load terminals, the voltage at the load terminals may be slightly lower.

Can I combine more than 1 cable together for the output wiring?

Yes. Cables can be used together (in parallel) if the current capacity of a single cable is insufficient. However the withstand voltage should also be taken into account. Ensure the cables are twisted together and are the same length.

The accuracy does not match the specification.

Make sure the device is powered On for at least 30 minutes, within +20°C~+30°C. This is necessary to stabilize the unit to match the specification.

For more information, contact your local dealer or GWInstek at www.gwinstek.com / marketing@goodwill.com.tw.

A PPENDIX

PFR-100 Factory Default Settings

The following default settings are the factory configuration settings for the power supply.

For details on how to return to the factory default settings, see page 40.

Initial Settings	Default Setting	
Output	Off	
LOCK	0 (Disabled)	
Voltage	0V	
Current	0A	
OVP	1.1 X Vrate	
OCP	1.1 X Irate	
UVL	0V	
Normal Function Settings	Setting	Default Setting
Output ON delay time	F-01	0.00s
Output OFF delay time	F-02	0.00s
V-I ode slew sate select	F-03	0 = CV high speed priority
Rising Voltage slew rate	F-04	100.0V/s (PFR-100L)
		500.0V/s (PFR-100M)
Falling Voltage slew rate	F-05	100.0V/s (PFR-100L)
		500.0V/s (PFR-100M)
Rising Current slew rate	F-06	20.00A/s (PFR-100L)
		4.000A/s (PFR-100M)
Falling Current slew rate	F-07	20.00A/s (PFR-100L)
		4.000A/s (PFR-100M)
Bleeder ON/OFF control	F-09	1 = ON
Buzzer ON/OFF control	F-10	1 = ON
Detection Time of OCP	F-12	0.0 sec
Current Setting limit	F-13	0 = OFF

Voltage Setting limit	F-14	0 = OFF
Memory Recall display	F-15	0 = OFF
Measurement average setting	F-17	0 = Low
Lock Mode	F-19	0 = Panel lock: allow output off
USB / GPIB setting	Setting	Default Setting
GPIB address	F-23	8
LAN setting	Setting	Default Setting
DHCP	F-37	1 = ON
Web password enable/disable	F-60	1 = Enable
Web password	F-61	0000
UART setting	Setting	Default Setting
UART Baudrate	F-71	7 = 115200
UART Data Bits	F-72	1 = 8 bits
UART Parity	F-73	0 = None
UART Stop Bit	F-74	0 = 1 bit
UART TCP	F-75	0 = SCPI
Power On Configuration setting	Setting	Default Setting
CV Control	F-90	0 = Panel control (local)
CC Control	F-91	0 = Panel control (local)
Power ON Output	F-92	0 = Safe Mode
External Output Logic Control	F-94	0 = High ON

Error Messages & Messages

The following error messages or messages may appear on the PFR-100 screen during operation.

Error Messages	Description
OHP	Over temperature protection
SENSE ALARM1	Sense Alarm1
SENSE ALARM2	Sense Alarm2
AC	AC fail
OVP	Over voltage protection
OCP	Over current protection
OPP	Over Power Protection
SHUT DOWN	Force shutdown
Err 001	USB mass storage is not present
Err 002	No (such)file in USB mass storage
Err 003	Empty memory location
Err 004	File access error
Err 005	File is too large
Err 007	Slave occurs Off-line (Multi-Drop mode)

Normal Messages	Description
MSG 001	External control of output. Output off (F-94=0, High=on)
MSG 002	External control of output. Output off (F-94=1, Low=on)

Communication Interface Messages	Description
MS ON	Mass storage plugged into front USB port
MS OFF	Mass storage removed from front USB port

LED ASCII Table Character Set

Use the following table to read the LED display messages.

0	1	2	3	4	5	6	7	8	9	A	B	C	D
0	1	2	3	4	5	6	7	8	9	A	b	C	d
E	F	G	H	I	J	K	L	M	N	O	P	Q	R
E	F	G	H	I	J	K	L	M	N	O	P	Q	r
S	T	U	V	W	X	Y	Z	()	+	-	,		
S	t	U	V	W	X	Y	Z	()	+	-	,		

PFR-100 Specifications

The specifications apply when the PFR-100 is powered on for at least 30 minutes.

Output

Model	PFR	100L	100M
Rated Output Voltage	V	50	250
Rated Output Current	A	10	2
Rated Output Power	W	100	100
Power ratio	—	5	5

Constant Voltage Mode

Model	PFR	100L	100M
Line regulation (*1)	mV	8	30
Load regulation (*2)	mV	10	33
Ripple and noise (*3)	p-p (*4)	mV	50
	r.m.s. (*5)	mV	4
Temperature coefficient (after a 30 minute warm-up)	ppm/ °C	100	100
Remote sense compensation voltage (single wire)	V	1	1
Rise time (*6)	Rated load	ms	50
	No load	ms	50
Fall time (*7)	Rated load	ms	100
	No load	ms	500
Transient response time (*8)	ms	1.5	2

Constant Current Mode

Model	PFR	100L	100M
Line regulation (*1)	mA	8	1.2
Load regulation (*9)	mA	10	3.2
Ripple and noise	r.m.s.	mA	10

Temperature coefficient (after a 30 minute warm-up)	ppm/ °C	200	200
---	---------	-----	-----

Protection Function

Model		PFR 100L	100M
Over voltage protection (OVP)	Setting range	V 5 - 55	5 - 275
	Setting accuracy	V 0.50	2.5
Over current protection (OCP)	Setting range	A 1 - 11	0.2 - 2.2
	Setting accuracy	A 0.20	0.040
Under voltage limit (UVL)	Setting range	V 0 - 52.5	0 - 262.5
Over temperature protection (OTP)	Operation	Turn the output off.	
Low AC input protection (AC-FAIL)	Operation	Turn the output off.	
Shutdown (SD)	Operation	Turn the output off.	
Over Power protection (OPP)	Operation	Turn the output off.	
	Value (fixed)	When output power is over 103% of rated power, the output will be turned off.	

Analog Programming and Monitoring

Model		PFR	100L	100M
External voltage control output voltage	Accuracy	V	0.50	2.50
External voltage control output current	Accuracy	mA	100	20
External resistor control output voltage	Accuracy	V	1.00	5.00
External resistor control output current	Accuracy	mA	200	40
Output voltage monitor	Accuracy	V	0.10	0.10
Output current monitor	Accuracy	V	0.10	0.10
Shutdown control	Turns the output off with a LOW (0V to 0.5V) or short-circuit.			
Output on/off control	Possible logic selections: Turn the output on using a LOW (0V to 0.5V) or short-circuit, turn the output off using a HIGH (4.5V to 5V) or open-circuit. Turn the output on using a HIGH (4.5V to 5V) or open-circuit, turn the output off using a LOW (0V to 0.5V) or short-circuit.			
Alarm clear control	Clear alarms with a LOW (0V to 0.5V) or short-circuit.			
CV/CC/ALM/PWR OFF/OUT ON indicator	Photocoupler open collector output; Maximum voltage 30V, maximum sink current 8mA.			

Front Panel

Model			PFR 100L	100M
Output voltage setting range		V	0 - 52.5	0 - 262.5
Output voltage resolution		mV	10	100
Output current setting range		A	0 - 10.5	0 - 2.1
Output current resolution		mA	10	1
Display, 4 digits	Voltage accuracy	0.1% of reading +	mV 40	200
	Current accuracy	0.2% of reading +	mA 20	2
Indications	GREEN LED's: CV, CC, VSR, ISR, DLY, RMT, LAN, M1, M2, M3, RUN RED LED's: ALM, ERR			

Buttons	Function(M1), Test(M2), Set(M3), Shift(PWR_DSPL), Lock/Local(Unlock), PROT(ALM_CLR), Output
Knobs	Voltage, Current
USB port	Type A USB connector
Binding Post	RED: Positive output, BLACK: Negative output, GREEN: Earth ground

Programming and Measurement (RS-232/485, USB, LAN, GPIB)

Model		PFR	100L	100M
Output voltage programming accuracy	0.1% of setting +	mV	40	200
Output current programming accuracy	0.2% of setting +	mA	20	2
Output voltage programming resolution		mV	2	10
Output current programming resolution		mA	1	0.1
Output voltage measurement accuracy	0.1% of reading +	mV	40	200
Output current measurement accuracy	0.2% of reading +	mA	20	2
Output voltage measurement resolution		mV	2	10
Output current measurement resolution		mA	1	0.1

Input Characteristics

Model		PFR	100L	100M
Input voltage range		Vac	85-265	
Input frequency range		Hz	47-63	
Maximum input current	100Vac	A	1.5	1.44
	200Vac	A	0.75	0.72
Inrush current			Less than 20A.	
Maximum input power		VA	150	
Power factor	100Vac		0.98	
	200Vac		0.95	
Efficiency	100Vac	%	70	72
	200Vac	%	72	74

Hold-up time	20ms or greater
--------------	-----------------

Interface Capabilities

Model	PFR	100L	100M
USB		Type A: Host, Type B: Slave, Speed: 1.1, USB Class: CDC (communications Device Class Class)	
RS-232/RS-485		Complies with the EIA-RS-232/RS-485 specifications (excluding the connector)	
LAN (Factory Optional)		MAC Address, DNS IP Address, User Password, Gateway IP Address, Instrument IP Address, Subnet Mask	
GPIO (Factory Optional)		SCPI-1993, IEEE 488.2 compliant interface	

Environment Conditions

Model	PFR	100L	100M
Operating temperature		0°C to 40°C	
Storage temperature		-20°C to 70°C	
Operating humidity		20% to 80% RH; No condensation	
Storage humidity		20% to 85% RH; No condensation	
Altitude		Maximum 2000m	

General Specifications

Model		PFR	100L	100M
Weight	main unit only	Kg	Approx. 2.5kg	
Dimensions	(W×H×D)	Mm*3	70 × 124 × 300	
Cooling			Natural convection cooling.	
EMC			Complies with the European EMC directive 2014/30/EU for Class A test and measurement products.	
Safety			Complies with the European Low Voltage Directive 2014/35/EU and carries the CE-marking.	
Withstand voltage	Between input and chassis		No abnormalities at 1500 Vac for 1 minute.	
	Between input and output		No abnormalities at 3000 Vac for 1 minute.	

	Between output and chassis	No abnormalities at 500 Vdc for 1 minute.
Insulation resistance	Between input and chassis	500 Vdc, 100M Ω or more
	Between input and output	500 Vdc, 100M Ω or more
	Between output and chassis	500 Vdc, 100M Ω or more

Notes:

(*1) At 85 ~ 132Vac or 170 ~ 265Vac, constant load.

(*2) From No-load to Full-load, constant input voltage. Measured at the sensing point in Remote Sense.

(*3) Measure with JEITA RC-9131B (1:1) probe

(*4) Measurement frequency bandwidth is 10Hz to 20MHz.

(*5) Measurement frequency bandwidth is 5Hz to 1MHz.

(*6) From 10% to 90% of rated output voltage, with rated resistive load.

(*7) From 90% to 10% of rated output voltage, with rated resistive load.

(*8) Time for output voltage to recover within 0.1% + 10mV of its rated output for a load change from 50 to 100% of its rated output current.

(*9) For load voltage change, equal to the unit voltage rating, constant input voltage.

PFR-100 Dimensions

PFR-100M, PFR-1000L

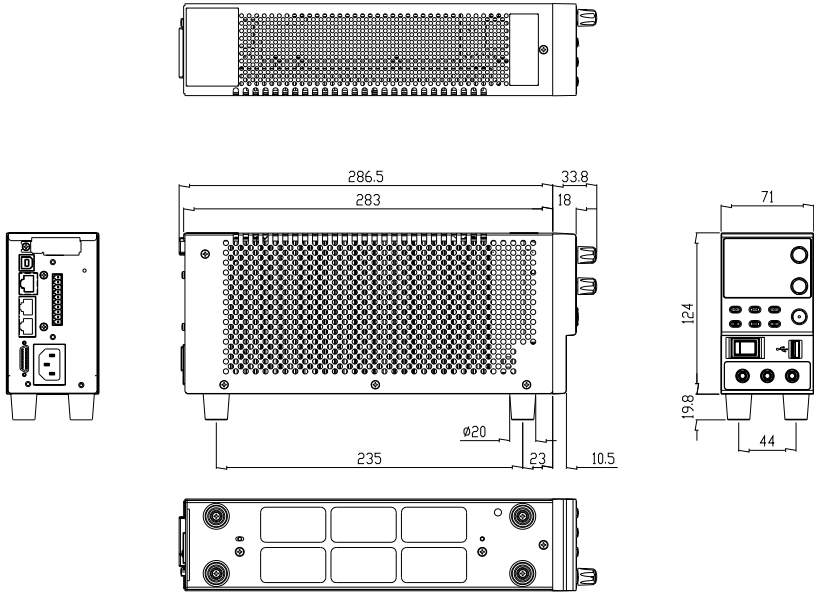

Declaration of Conformity

We

GOOD WILL INSTRUMENT CO., LTD.

declare that the below mentioned product

Type of Product: Programmable DC Power Supply

Model Number: PFR-100M, PFR-100L

are herewith confirmed to comply with the requirements set out in the Council Directive on the Approximation of the Law of Member States relating to EMC (2014/30/EU), LVD (2014/35/EU), WEEE (2012/19/EU) and RoHS (2011/65/EU).

For the evaluation regarding the Electromagnetic Compatibility and Low Voltage Directive, the following standards were applied:

© EMC	
EN 61326-1 : EN 61326-2-1:	Electrical equipment for measurement, control and laboratory use — EMC requirements (2013)
Conducted and Radiated Emissions EN 55011:2016	Electrical Fast Transients EN 61000-4-4: 2012
Current Harmonic EN 61000-3-2:2014	Surge Immunity EN 61000-4-5: 2014
Voltage Fluctuation EN 61000-3-3:2013	Conducted Susceptibility EN 61000-4-6: 2014
Electrostatic Discharge EN 61000-4-2: 2009	Power Frequency Magnetic Field EN 61000-4-8:2010
Radiated Immunity EN 61000-4-3:2006+A1:2008+A2:2010	Voltage Dips/ Interrupts EN 61000-4-11: 2004
Low Voltage Equipment Directive 2014/35/EU	
Safety Requirements	EN 61010-1:2010 (Third Edition)

GOODWILL INSTRUMENT CO., LTD.

No. 7-1, Jhongsing Road, Tucheng District, New Taipei City 236, Taiwan

Tel: [+886-2-2268-0389](tel:+886-2-2268-0389)

Fax: [+886-2-2268-0639](tel:+886-2-2268-0639)

Web: <http://www.gwinstek.com>

Email: marketing@goodwill.com.tw

GOODWILL INSTRUMENT (SUZHOU) CO., LTD.

No. 521, Zhujiang Road, Snd, Suzhou Jiangsu 215011, China

Tel: [+86-512-6661-7177](tel:+86-512-6661-7177)

Fax: [+86-512-6661-7277](tel:+86-512-6661-7277)

Web: <http://www.instek.com.cn>

Email: marketing@instek.com.cn

GOODWILL INSTRUMENT EURO B.V.

De Run 5427A, 5504DG Veldhoven, The Netherlands

Tel: [+31-\(0\)40-2557790](tel:+31-(0)40-2557790)

Fax: [+31-\(0\)40-2541194](tel:+31-(0)40-2541194)

Email: sales@gw-instek.eu

INDEX

Accessories	11	test function settings.....	60
Alarm		UART settings.....	76
description	26	USB/GPIB settings	74
Analog connector		Conventions	39
pin assignment	85	CV mode	
Analog control		operation.....	47
output control.....	97	Declaration of conformity.....	147
overview.....	83	Default settings	136
remote monitoring	102	reset	40
resistance control – current		Display format	139
output	95	Display mode	
resistance control – voltage		operation.....	53
output	93	Disposal instructions.....	7
shutdown control	99, 100	EN61010	
status monitoring	104	pollution degree.....	7
voltage control – current output.	90	Environment	
voltage control – voltage output	88	safety instruction	6
ASCII table character set	139	Error messages.....	138
Bleeder control		Ethernet	
description	24, 25	interface.....	125
Build date		sockets	128
view	42	web server	125
Caution symbol	5	FAQ	134
CC and CV mode		Ground	
description	22	symbol.....	5
CC mode		Grounding	30
operation	50	How to use the instrument.....	39
Cleaning the instrument.....	6	List of features.....	10
Configuration		Marketing	
LAN settings.....	75	contact	135
Normal function settings.....	71	Messages.....	138
normal function settings		Model differences	10
operation	79	OCP level	44
power on configuration operation	81	Operating area description.....	20
power on configuration settings.	78	Operation considerations	27
script test settings.....	59	floating output	30
special function settings.	79	inrush current.....	27
System settings	77	pulsed loads	27
table.....	67		

reverse current	29	USB configuration	108
Optional accessories	11	USB function check	109
Output connector pinout	36	Remote sense connector	56
Output terminal	35	Save setup	54
cover	38	Service operation	
OVP level	44	about disassembly	6
Package contents	11	contact	135
Panel lock	54	Slew rate	
Power sequence	33	description	23
Rack mount		Socket server function check ..	129
description	39	Specifications	140
Rear panel diagram	18	System version	
Recall setup	55	view	42
Remote control	107	Test script	
Ethernet configuration	125	check available memory	65
Ethernet function check	126	Export	64
GPIB configuration	111	Load	61
GPIB function check	112	overview	59
interface configuration	108	remove/delete test	65
local bus configuration	121	Run	62
multi-unit configuration	121	UK power cord	8
multi-unit function check	123	UVL level	44
sockets configuration	128	Warning symbol	5
sockets function check	129	Web server function check	126
UART configuration	116		
UART function check	119		