

# DC Electronic Load

PEL-3000E Series

---

## USER MANUAL

VERSION: 1.11



ISO-9001 CERTIFIED MANUFACTURER

**GW INSTEK**

This manual contains proprietary information, which is protected by copyright. All rights are reserved. No part of this manual may be photocopied, reproduced or translated to another language without prior written consent of Good Will company.

The information in this manual was correct at the time of printing. However, Good Will continues to improve products and reserves the rights to change specification, equipment, and maintenance procedures at any time without notice.

# Table of Contents

<b>SAFETY INSTRUCTIONS</b> .....	<b>3</b>
<b>GETTING STARTED</b> .....	<b>8</b>
PEL-3000E Introduction .....	9
Accessories .....	10
Appearance .....	12
First Time Use Instructions .....	20
<b>OPERATION</b> .....	<b>36</b>
Basic Operation .....	39
Basic Configuration .....	51
Advanced Configuration Settings .....	58
Step Resolution Configuration .....	69
Protection Settings .....	72
System Settings .....	78
Go-NoGo .....	81
Program .....	84
Sequence .....	93
Save Recall .....	112
<b>FUNCTION MENU</b> .....	<b>127</b>
Function Menu Overview .....	128
Program .....	134
Sequence .....	142
OCP Test Automation .....	162
OPP Test Automation .....	168
BATT Test Automation .....	174
<b>EXTERNAL CONTROL</b> .....	<b>182</b>
Analog Control .....	183
Trigger In/Out BNC .....	199

<b>REMOTE CONTROL</b> .....	<b>201</b>
Interface Configuration .....	202
<b>FAQ</b> .....	<b>212</b>
<b>APPENDIX</b> .....	<b>214</b>
Replacing the Dust Filter .....	215
GPIB Installation .....	216
PEL-3000E Default Settings.....	217
Frame Control Connector Contacts .....	220
Operating Mode Description .....	222
Operating Area .....	227
PEL-3000E Specifications.....	229
PEL-3000E Dimensions.....	236
Declaration of Conformity.....	237
<b>INDEX</b> .....	<b>238</b>

# S SAFETY INSTRUCTIONS

This chapter contains important safety instructions that you must follow during operation and storage. Read the following before any operation to insure your safety and to keep the instrument in the best possible condition.

## Safety Symbols

These safety symbols may appear in this manual or on the instrument.

---



WARNING

Warning: Identifies conditions or practices that could result in injury or loss of life.



CAUTION

Caution: Identifies conditions or practices that could result in damage to the instrument or to other properties.



DANGER High Voltage



Attention Refer to the Manual



Earth (ground) Terminal



Frame or Chassis Terminal



Do not dispose electronic equipment as unsorted municipal waste. Please use a separate collection facility or contact the supplier from which this instrument was purchased.

## Safety Guidelines

---

### General Guideline



### CAUTION

- Do not place any heavy object on the instrument.
- Avoid severe impact or rough handling that leads to damaging the instrument.
- Do not discharge static electricity to the instrument.
- Use only crimped wires, not bare wires, for the terminals.
- Do not block the cooling fan opening.
- Do not disassemble the instrument unless you are qualified.
- The equipment is not for measurements performed for CAT II, III and IV.

(Measurement categories) EN 61010-1:2010 specifies the measurement categories and their requirements as follows. The instrument falls under category II.

- Measurement category IV is for measurement performed at the source of low-voltage installation.
  - Measurement category III is for measurement performed in the building installation.
  - Measurement category II is for measurement performed on the circuits directly connected to the low voltage installation.
  - 0 is for measurements performed on circuits not directly connected to Mains.
-

<p>Power Supply</p>  WARNING	<ul style="list-style-type: none"><li>• AC Input voltage range: 100-120VAC/200-240VAC (90-132VAC/180-250VAC)</li><li>• Frequency: 47-63Hz</li><li>• Power: 90VA Max</li><li>• To avoid electrical shock connect the protective grounding conductor of the AC power cord to an earth ground.</li></ul> <hr/>
Cleaning	<ul style="list-style-type: none"><li>• Disconnect the power cord before cleaning.</li><li>• Use a soft cloth dampened in a solution of mild detergent and water. Do not spray any liquid.</li><li>• Do not use chemicals containing harsh material such as benzene, toluene, xylene, and acetone.</li></ul> <hr/>
Operation Environment	<ul style="list-style-type: none"><li>• Location: Indoor, no direct sunlight, dust free, almost non-conductive pollution (Note below)</li><li>• Temperature: 0°C to 40°C</li><li>• Humidity: 0 to 85% RH</li><li>• Altitude: &lt;2000m</li></ul> <p>(Pollution Degree) EN 61010-1:2010 specifies the pollution degrees and their requirements as follows. The instrument falls under degree 2.</p> <p>Pollution refers to “addition of foreign matter, solid, liquid, or gaseous (ionized gases), that may produce a reduction of dielectric strength or surface resistivity”.</p> <ul style="list-style-type: none"><li>• Pollution degree 1: No pollution or only dry, non-conductive pollution occurs. The pollution has no influence.</li><li>• Pollution degree 2: Normally only non-conductive pollution occurs. Occasionally, however, a temporary conductivity caused by condensation must be expected.</li><li>• Pollution degree 3: Conductive pollution occurs, or dry, non-conductive pollution occurs which becomes conductive due to condensation which</li></ul> <hr/>

is expected. In such conditions, equipment is normally protected against exposure to direct sunlight, precipitation, and full wind pressure, but neither temperature nor humidity is controlled.

---

Storage environment

- Location: Indoor
  - Temperature: -20°C to 70°C
  - Humidity: <90% RH
- 

Disposal



Do not dispose this instrument as unsorted municipal waste. Please use a separate collection facility or contact the supplier from which this instrument was purchased. Please make sure discarded electrical waste is properly recycled to reduce environmental impact.



## Power cord for the United Kingdom

When using the instrument in the United Kingdom, make sure the power cord meets the following safety instructions.

NOTE: This lead/appliance must only be wired by competent persons

 **WARNING: THIS APPLIANCE MUST BE EARTHED**

IMPORTANT: The wires in this lead are coloured in accordance with the following code:

Green/ Yellow:	Earth
Blue:	Neutral
Brown:	Live (Phase)



As the colours of the wires in main leads may not correspond with the coloured marking identified in your plug/appliance, proceed as follows:

The wire which is coloured Green & Yellow must be connected to the Earth terminal marked with either the letter E, the earth symbol  or coloured Green/Green & Yellow.

The wire which is coloured Blue must be connected to the terminal which is marked with the letter N or coloured Blue or Black.

The wire which is coloured Brown must be connected to the terminal marked with the letter L or P or coloured Brown or Red.

If in doubt, consult the instructions provided with the equipment or contact the supplier.

This cable/appliance should be protected by a suitably rated and approved HBC mains fuse: refer to the rating information on the equipment and/or user instructions for details. As a guide, a cable of 0.75mm<sup>2</sup> should be protected by a 3A or 5A fuse. Larger conductors would normally require 13A types, depending on the connection method used.

Any exposed wiring from a cable, plug or connection that is engaged in a live socket is extremely hazardous. If a cable or plug is deemed hazardous, turn off the mains power and remove the cable, any fuses and fuse assemblies. All hazardous wiring must be immediately destroyed and replaced in accordance to the above standard.

# GETTING STARTED

This chapter provides a brief overview of the PEL-3000E, the package contents, instructions for first time use and an introduction to the front panel, rear panel and GUI.



PEL-3000E Introduction .....	9
Overview .....	9
Main Features .....	9
Accessories .....	10
Package Contents .....	11
Appearance .....	12
PEL-3000E Front Panel (PEL-3031E/PEL-3032E) .....	12
Rear Panel (PEL-3031E/PEL-3032E) .....	16
Display .....	19
First Time Use Instructions .....	20
Power Up and Self Test .....	20
Load Default Settings .....	21
Load Wiring .....	21
Load Wire Connections .....	24
Using the Front Panel Input Terminals .....	25
Remote Sense .....	26
Firmware Update .....	27
Conventions .....	29
Help Menu .....	35

## PEL-3000E Introduction

The PEL-3000E is an economic, standalone, high performance DC electronic load positioned to test a wide range of different power sources. The DC electronic load is fully programmable to simulate anything from basic static loads to complex dynamic loads. The PEL-3000E is extremely robust and capable of molding to any test environment.

### Overview

Model	Operating Voltage (DC)	Current	Power
PEL-3031E	1V-150V	6A (Low range) 60A (High range)	300W
PEL-3032E	2.5V-500V	1.5A (Low range) 15A (High range)	300W

### Main Features

Performance	<ul style="list-style-type: none"> <li>• High slew rates of up to 2.5A/<math>\mu</math>s (PEL-3031E) for a fast response speed</li> <li>• High resolution - 16 bit</li> </ul>
Features	<ul style="list-style-type: none"> <li>• 7 operating modes: CC, CV, CR, CP, CC+CV, CR+CV, CP+CV</li> <li>• Fully programmable with normal and fast sequences</li> <li>• Soft start</li> <li>• Dynamic mode</li> <li>• OCP, OVP and other protection features</li> <li>• Remote sense</li> <li>• Integrated meter</li> <li>• Rack-mountable</li> </ul>

- Interface
- USB and GPIB
  - External voltage or resistance control
  - Rear panel trigger in/out BNC
  - Analog external control

## Accessories

Standard Accessories	Part number	Description
		Quick Start Guide
		User / Programming manual CD
	Region dependent	Power cord
	61SF-062104N1	Front terminal washers  —Spring washer (M6) x2
	GTL-105A	Remote sense cables, red x1, black x1

Optional Accessories	Part number	Description
	GTL-248	GPIB cable, 2.0m
	GTL-246	USB cable, Type A - Type B
	PEL-010	Dust Filter

Options	Part number	Description
	PEL-004	GPIB option

## Package Contents

Check the contents before using the instrument.

---

### Opening the box

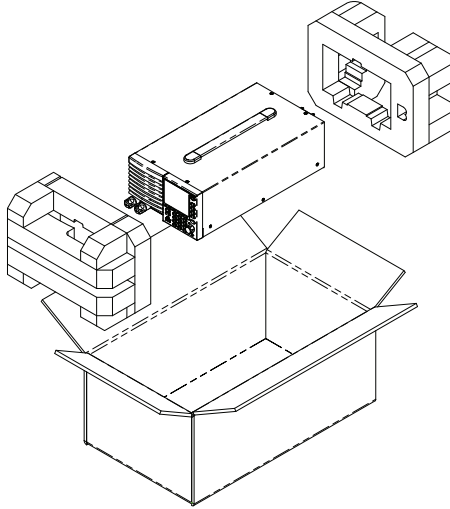

### Contents (single unit)

- Main unit
- Quick Start manual
- User / Programming manual CD
- Power cord x1 (region dependent)
- Calibration certificate

# Appearance

## PEL-3000E Front Panel (PEL-3031E/PEL-3032E)

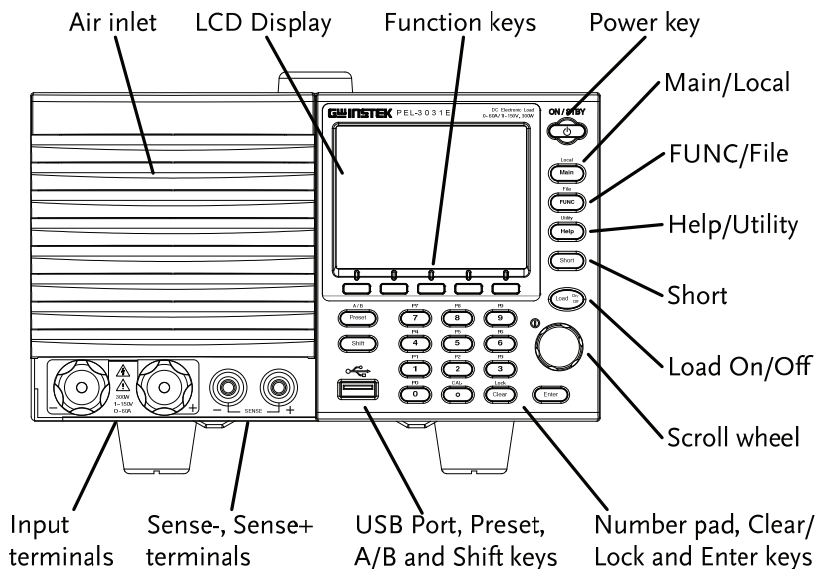







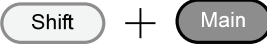

**Air Inlet**                      The air inlet has a removable dust filter

**LCD display**                 3.5 inch LCD display

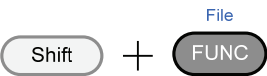
**Function keys**              

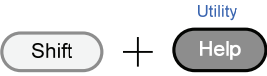
The function keys directly correspond to the soft menu keys at the bottom of the display.

ON/STBY		Turns the unit on or puts the unit into standby mode. Use the power switch on the rear panel to turn the unit off.
Main/Local		Main: Sets the operating mode: CC, CV, CR, CP mode.
		Local (Shift + Main): Puts the instrument back into local mode from remote mode.
FUNC/File		FUNC: Sets the program function, sequence function or other special functions.
		File (Shift + FUNC): Accesses the file system.
Help/Utility		Help: Access the help menu.
		Utility (Shift + Help): Access the utility menu.
Short		Pressing the Short key will simulate shorting the input terminals.
		The Short key will be lit when active.
Load on/off		Turns the load on or off.
		The Load On/Off key will be lit when active.

Scroll wheel

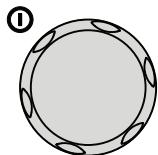

Use the scroll wheel to navigate the menu system or to edit parameters. See page 29 for usage details.

Enter



Press the Enter key to select highlighted menu items.

Number pad

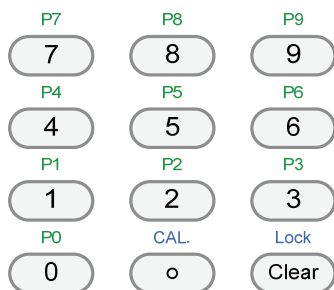

Number pad: Used to enter numerical values.

P0-P9 (Preset + Number keys): Loads one of 10 preset settings.

Clear/Lock



Clear: Clears the current parameter values.

Lock (Shift + Clear): Locks the front panel keys and selector knob.

Shift

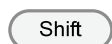

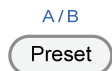

Shift: Used in conjunction with other keys to select secondary functions.

Preset



Used in conjunction with the number pad to save or load preset settings P0 to P9.

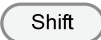

 + <sup>A/B</sup> 

The A/B function is used to manually switch from Level A to Level B when in CC or CR static mode.

USB Port

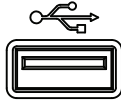

USB A port. Used for save and recall functions.

Front panel input terminals

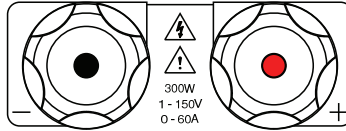

Negative terminal.

Positive terminal.

Sense Ports

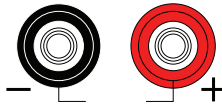

Sensing ports for remote sense. See page 26.

Rear Panel (PEL-3031E/PEL-3032E)

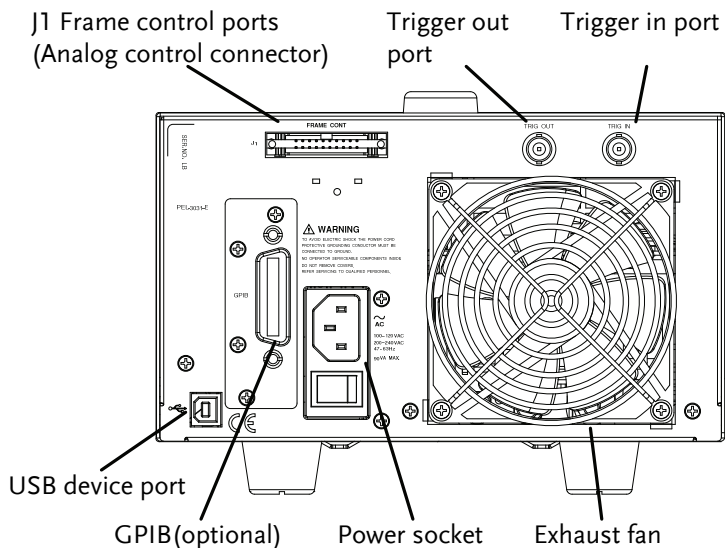

GPIB

The USB B and GPIB port are used for remote control.

USB B

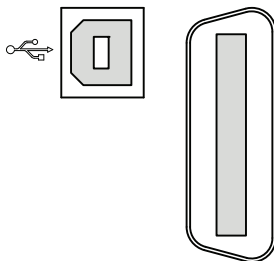

USB B port

GPIB 24 pin female.

J1 Frame control ports (Analog control connector)

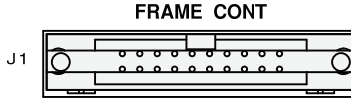

The J1 connector is assigned to perform external control and monitoring.

Exhaust fan

The exhaust fan is used to expel the heat from the unit. Please ensure there is at least 20cm distance between any object and the fan.

Power Socket

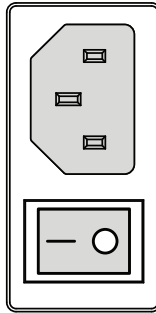

Power Socket:  
100-120V, 200-240V  
47-63Hz.

Power Switch

Turns the unit on/off.

USB A

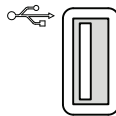

USB A Slave port. USB 1.1/2.0

TRIG OUT



Trigger out BNC terminal:  
Outputs a pulse signal during sequence or dynamic operation. The trigger signal has a 4.5V output with a pulse width of at least 2 $\mu$ s and an impedance of 500 $\Omega$ .

TRIG IN



Trigger input BNC terminal:  
This terminal is used to externally resume sequences that have been paused. Pulled down internally to ground by a 100k $\Omega$  resistor.

## Display

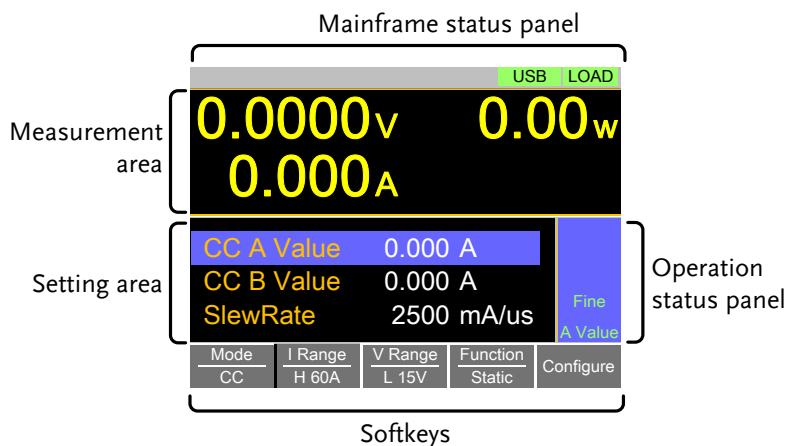

- 
- Setting Area**      The setting area is used to display and edit the settings for the current mode/function.
- Measurement Area**      Displays the voltage, current and power values.
- Mainframe Status Panel**      The mainframe status panel displays the status of the load, remote control and short function.
- When an icon is green it indicates that the function is off. When the icon is orange, the function is on.
- Operation Status Panel**      This status panel is used to display the status of the current mode.
- Soft-keys**      The soft-key menus are used to select different functions or parameters.

## First Time Use Instructions

Use the procedures below when first using the PEL-3000E to install the rack mount kit, power up the instrument, restore the factory default settings and check the firmware version. Lastly, the Conventions section will introduce you to the basic operating conventions used throughout the user manual.

### Power Up and Self Test

---

#### Steps

1. Insert the AC power cord into the power socket.

2. Turn the external power switch on.  
(O → —)

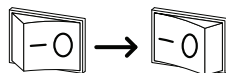

3. If the unit doesn't turn on, press the On/Standby key.
  - The ON/STBY key will go from standby (red) to on (green).

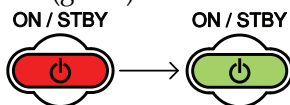

4. The unit will show the splash screen and then load the settings from when the unit was last powered down.



Note

If the PEL-3000E fails to start up properly or does not turn on, please see your local distributor.

## Load Default Settings

---

**Description** When first using the PEL-3000E, recall the factory default settings to ensure the unit is in a known state. See page 217 for a list of the default settings.

**Operation**

1. Press **Shift** + **File** (**FUNC**).

Select *Media/Default*[F1].  
 Select *Factory Default*[F2].

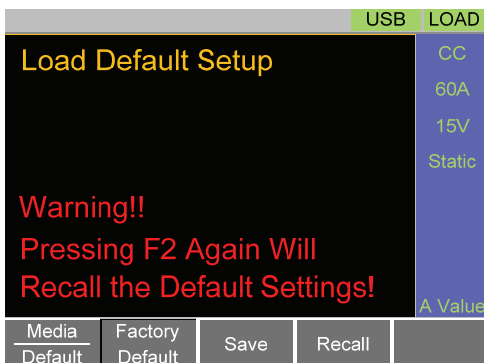

## Load Wiring

---

**Wire Gauge considerations** Before connecting the unit to a power source, the wire gauge must be taken into account. Load wires must be large enough to resist overheating when a short-circuit condition occurs as well as to maintain a good regulation. The size, polarity and length of a wire are all factors in determining if a wire will withstand short circuiting.

Wires that are selected must be large enough to withstand a short circuit and limit voltage drops to no more than 2V per wire. Use the table below to help make a suitable selection.

AWG Gauge	Conduct or Diameter mm	Ohms per km	Max amps for chassis wiring
8	3.2639	2.0605	73
9	2.90576	2.59809	64
10	2.58826	3.27639	55
11	2.30378	4.1328	47
12	2.05232	5.20864	41
13	1.8288	6.56984	35
14	1.62814	8.282	32

**Load Line Inductance Considerations**

When using the PEL-3000E load generator, voltage drop and voltage generated due to load line inductance and current change must be taken into account. Extreme changes in voltage may exceed the minimum or maximum voltage limits. Exceeding the maximum voltage limit may damage the PEL-3000E.

To determine the voltage generated, the following equation can be used.

$$E = L \times (\Delta I / \Delta T)$$

E= voltage generated

L=load line inductance

$\Delta I$ = change of current (A)

$\Delta T$ = time (us)

Load line inductance (L) can be approximated as 1uH per 1 meter of wire. ( $\Delta I / \Delta T$ ) is the



slew rate in A/us.

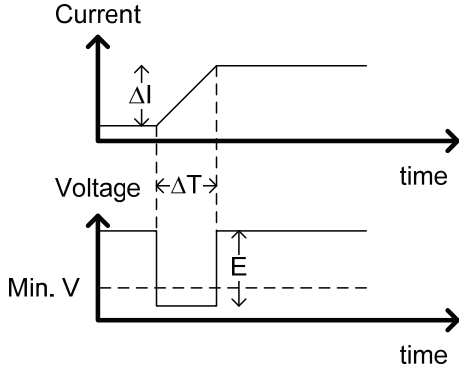

The diagram above shows how changes in current can affect voltage.

Limiting Load line inductance

Load line inductance can be reduced in two ways.

1. Ensure load wires are as short as possible and twist the positive and negative load wires together.
2. Current change can be limited by limiting the slew rate speed when switching in CR and CC mode.

“Twisted pair” will be shown on any connection diagram where the load wires should be twisted together.

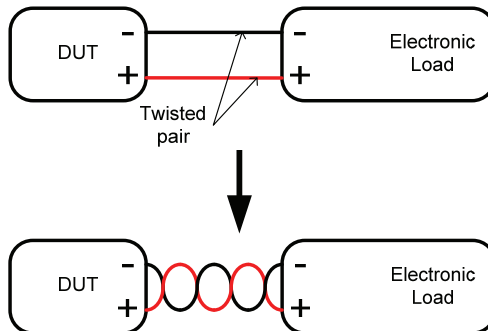

## Load Wire Connections

**Description**                      The PEL-3000E has input terminals on the front panel.

Follow the procedures below for the load connection. Please adhere to the following precautions to ensure your safety and to protect the unit from damage.

**Connection**                      When connecting the PEL-3000E to the DUT, make sure that the polarity of the connection between the DUT and the unit matches.

Ensure that the maximum input voltage is not exceeded. The maximum input voltage is 150 volts (PEL-3031E).

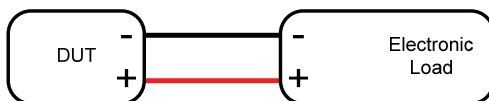

 **Caution**

If the polarity to the input terminals is reversed, the reverse voltage protection function is tripped. The reverse voltage protection function is tripped when reverse voltages greater than -0.3V are detected.

 **Warning**

Do not touch any of the input terminals when the unit is on.

 **Warning**

Connecting the input terminals to the wrong polarity can damage the DUT or the PEL-3000E.

## Using the Front Panel Input Terminals

---

**Description** The front panel input terminals feature polarity-distinct caps and accept M6 sized crimped terminals.

---

- Steps**
1. Turn the power off from the rear panel or put the unit into standby mode.
  2. Turn the power off from the DUT.
  3. Connect the load wires to the input terminals:
    - Connect the positive (+) input terminal on the load generator to the high potential output of the DUT.
    - Connect the negative (-) input terminal to the low potential output of the DUT.

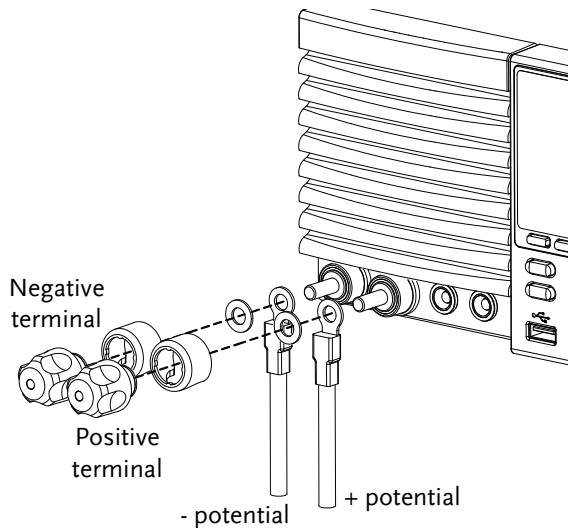

## Remote Sense

---

**Description** Remote sense can be used to help compensate for long cable length. The longer the cable, the higher the potential resistance and inductance, therefore a short cable is best. Twisting the cable can help reduce induced inductance and using the Vsense terminals compensates the voltage drop seen across the load leads, especially leads with higher resistance. This is useful when used in CV, CR or CP mode.

- Steps**
1. Turn the power off from the rear panel or put the unit into standby mode.
  2. Turn the power off from the DUT.
  3. Connect the DUT to the load terminals, see page 21, 24.
  4. Connect the sense wires to the sense terminals:
    - Connect the positive sense (+S) terminal to the high potential output of the DUT.
    - Connect the negative sense (-S) terminal to the low potential output of the DUT.

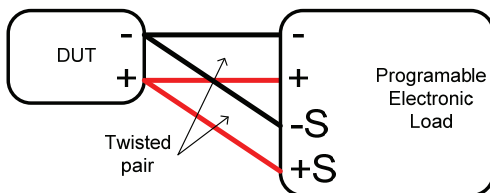



Warning

Ensure that the load is connected to the DUT before connecting the sense wires. If only the sense wires are connected to the DUT, the load will be seen at the sense terminals. This will result in an internal fuse entering a high-impedance state due to over temperature. At this point, any measured values will be erroneous. You must wait for the temperature to return to normal operating temperature before the unit should be used again.



## Firmware Update

---

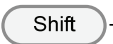

**Description** The PEL-3000E allows the firmware to be updated by end-users. Before using the PEL-3000E, please check the GW Instek website or ask your local distributor for the latest firmware.

---

**System version** Before updating the firmware, please check the firmware version.

- Operation**
1. Press  + .
  2. Select *System/Info[F1]*.
  3. The System information is listed on the display.
    - Model: PEL-3000E model number.
    - Serial Number: XXXXXXXX
    - Firmware Ver.: X.XX.XXX.
    - Website address.
  4. To view other system information, press *System[F1]* and select *Memo*.



- Update Firmware
1. Insert a USB drive into the USB port. Ensure the USB drive has the firmware file located in the root directory.
  2. Press  +  .  
File
  3. Select USB with the *Media*[F1] soft-key.
  4. Press the *File Utility*[F5] soft-key.
  5. Select the \*.UPG upgrade file and press *Select*[F1] twice. Once to select the file and once to confirm.
  6. Wait for the update to complete and reset the power when prompted.

**Note**

Do not turn the load generator off or remove the USB memory when the firmware is being read or upgraded.

## Conventions

The following conventions are used throughout the user manual. Read the conventions below for a basic grasp of how to operate the PEL-3031E menu system using the front panel keys.

### Soft Menu keys

The F1 to F5 function keys at the bottom of the display correspond directly to the soft-menu keys on top.

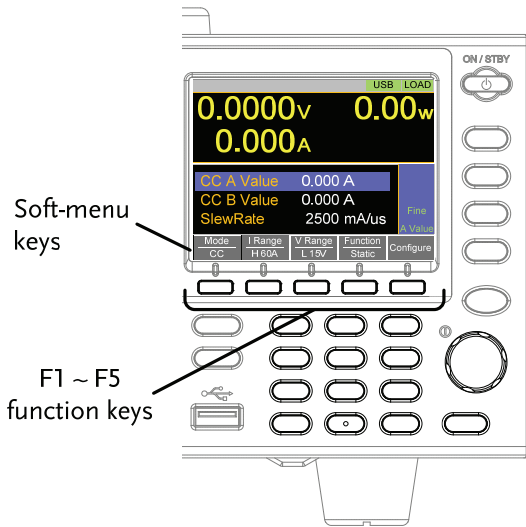

### Select Sub Menu

Configure

Pressing this type of soft-menu key will enter a submenu.

Toggle Parameter or State

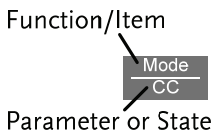

This type of soft-menu icon has the function/item on the top of the label and the selected setting or mode on the bottom of the label.

Repeatedly press the associated function key (F1-F5) to cycle through each setting. For example, repeatedly pressing the *Mode* soft-menu key will cycle through the CC, CR, CV and CP modes.

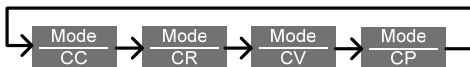

For some parameters, a popup window will also appear. Selection of the setting is the same. Repeatedly pressing the relevant function key (F1-F5) will cycle through each setting. The selection on the popup window will also be reflected on the label.

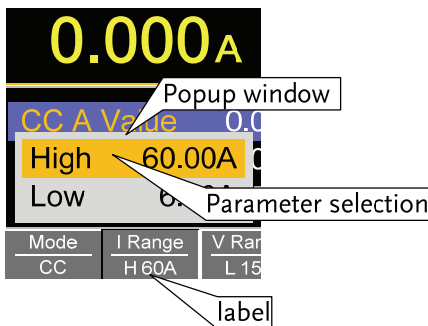



Parameter Input

The scroll wheel, Enter key and number pad can be used to edit parameter values.

Number pad

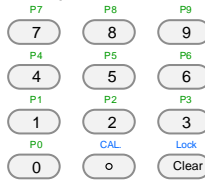

Scroll wheel



Enter key

1. Use the scroll wheel to move the cursor to the desired parameter.
- A scroll bar is shown when there are additional parameters off-screen.

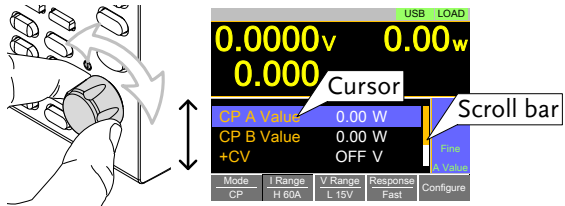

2. Press the Enter key to select the parameter. The parameter will become highlighted in white.

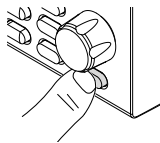

3. Then use the number pad\* or scroll wheel\*\* to edit the parameter value.

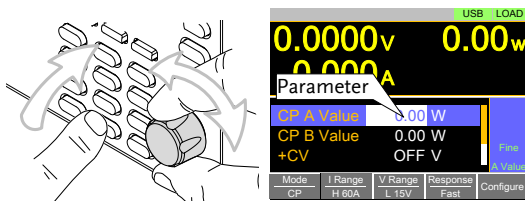

4. Press the Enter key again to finish editing the parameter value.

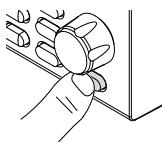

**Clearing a Value\***

\*When editing a parameter with the number pad, pressing the **Clear** key will restore the parameter to the previous value.

**Using the Scroll Wheel to Edit a Parameter\*\***

\*\*To edit a parameter using the scroll wheel, simply turn the scroll wheel. Clockwise increases the value, counterclockwise decrease the value.

Pressing the scroll wheel when a parameter is highlighted allows you to change the step resolution. There are two different step resolution methods: Step Mode and Cursor Mode.

Step Mode: This is the default step resolution method and will only be available to use when it is applicable (Indicated by *Fine* or *Coarse* in the Operation Status panel).

When a parameter is highlighted (step 3 above) pressing the scroll wheel will toggle the step resolution between fine and coarse. For details on how to set the step resolution, see page 70.

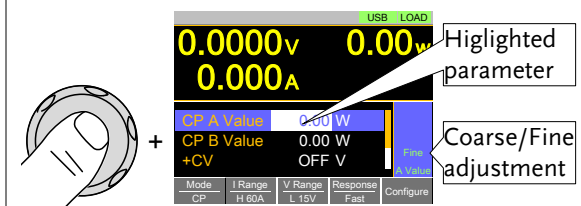

Cursor Mode: This method must first be enabled before it can be used. Pressing the scroll wheel when a parameter is highlighted allows you to set the step resolution by a digit value. An orange line will appear under the currently selected digit value. Repeatedly pressing the scroll wheel moves to the next digit. See page 69 for details.

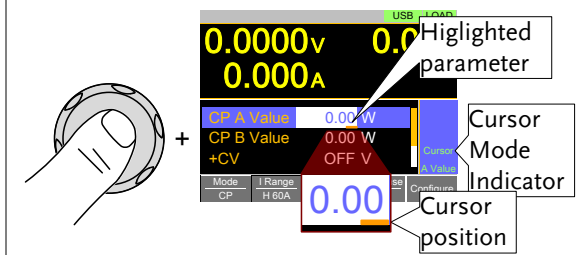

Entering Alphanumeric Characters

When renaming files, creating memos or notes, you will be required to enter alphanumeric characters when the character entry screen appears.

- Only alphanumeric characters as well as space [ ], underscore [ \_ ] and minus [ - ] characters allowed.
1. Use the scroll wheel to move the cursor to the desired character.

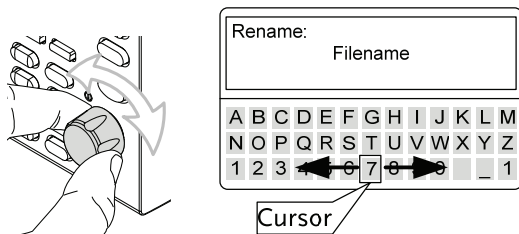

2. Press the **Enter** key or *Enter Character*[F1] to select a character.

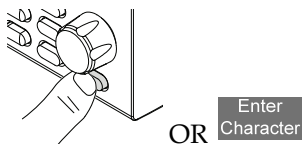

3. To delete a character, press *Back Space*[F2].
4. To save the file name or memo, press *Save*[F3].

## Help Menu

When any function key has been pressed or when a menu has been opened, the HELP key can be used to display a detailed description.

---

- Help Selection
1. Press any function key or soft-menu key.
  2. Press  to see the help contents on that particular function key or menu.
  3. Use the scroll to navigate the help contents.
  4. Press the *Exit[F5]* key to exit the help menu.

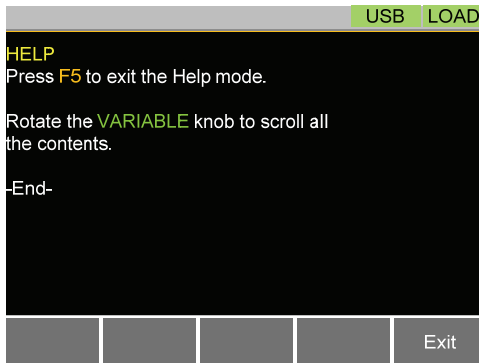

# OPERATION

---

Basic Operation .....	39
CC Mode .....	39
CR Mode .....	41
CR Units .....	43
CV Mode .....	43
CP Mode .....	45
+CV Mode .....	46
Turning on the Load .....	48
Shorting the Load .....	49
Short Key Configuration .....	50
Locking the Front Panel Controls .....	50
Basic Configuration .....	51
Select the Switching Function .....	51
Select the Display Units for Dynamic Mode Levels .....	54
Select the Switching Time Configuration for Dynamic Mode .....	55
Slew Rate .....	55
CV/CP Mode Response Speed .....	56
Advanced Configuration Settings .....	58
Soft Start Setting .....	58
Von Voltage Settings .....	59
Von Voltage Level .....	59
Von Voltage Latch .....	60
Von Voltage Delay .....	61
Timer Functions .....	61
Count Time .....	61
Cut Off Time .....	62
Auto Load Configuration .....	63
Load Off (Mode) and Load Off (Range) .....	64
Short Safety .....	65
Short Function Enable/Disable .....	65
Locking the Front Panel Controls .....	66
Input/Output Trigger Settings .....	67
Trigger In Status .....	67
Trigger In Delay .....	67
Trigger Out Status .....	67
Trigger Out Width .....	68

Step Resolution Configuration .....	69
Cursor Mode Configuration .....	69
Step Mode Configuration .....	70
Protection Settings .....	72
OCP .....	72
OPP .....	73
UVP .....	75
OVP .....	76
UnReg .....	77
System Settings .....	78
Sound Settings .....	78
Speaker Settings .....	78
Alarm Tone Settings .....	79
Display Settings .....	79
Contrast and Brightness .....	79
Control Settings .....	80
Language Settings .....	80
Go-NoGo .....	81
Setting the Go-NoGo Limits .....	81
Running a Go-NoGo Test .....	82
Program .....	84
Program Overview .....	84
Create a Program .....	86
Create a Program Chain .....	90
Running a Program or Chain .....	91
Sequence .....	93
Normal Sequence Overview .....	93
Timing Edit Configuration .....	98
Data Edit Configuration .....	99
Running a Normal Sequence .....	101
Fast Sequence Overview .....	103
Timing Edit Configuration .....	107
Data Edit Configuration .....	108
Running a Fast Sequence .....	110
Save Recall .....	112
File Structure .....	112
File Types .....	113
Saving Files to Internal Memory .....	115
Saving Files to USB Memory .....	116
Recalling Files from Internal Memory .....	119
Recalling Files from USB Memory .....	120
Recall Memory Safety Setting .....	122
File Utility .....	123

Preset.....	124
Quick Preset Save .....	124
Quick Preset Recall.....	125
Default Settings .....	125
Factory Default Settings.....	125
User's Default Setting.....	126



## Basic Operation

The PEL-3000E supports 7 main operating modes:

CC, CC+CV;

CR, CR+CV;

CV;

CP, CP+CV

### CC Mode

Description	In Constant Current Mode the load units will sink the amount of current programmed. Regardless of the voltage, the current will stay the same. For more details on CC mode, please see the Appendix on page 222.
-------------	--



Warning

If you change the mode or the range when the load is already on, the load will be turned off automatically.

Operation	<ol style="list-style-type: none"> <li>1. Make sure the load is off.</li> <li>2. Press .</li> <li>3. Select CC mode with the <i>Mode[F1]</i> soft-key.</li> <li>4. Select the current range with the <i>I Range[F2]</i> soft-key. Range: High, Low</li> <li>5. Select the voltage range with the <i>V Range[F3]</i> soft-key. Range: High, Low</li> </ol>
-----------	---

6. Set the current level parameters using the scroll wheel and number pad.
  - For Static mode, set *CC A Value* and/or *CC B Value*.
  - For Dynamic mode, set *Level1* and *Level2*.
  - The maximum and minimum current levels depend on the selected ranges.
7. To add CV mode to CC mode (CC+CV), see page 46.
1. Set the remaining basic configuration settings such as the slew rate and switching mode settings. See page 51 for details.

Display

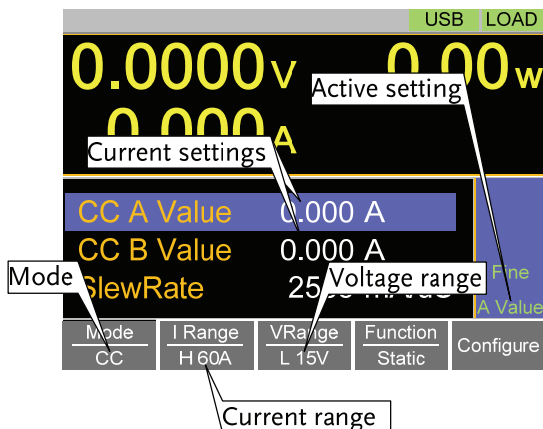

 Note

Basic CC mode configuration is complete. See page 51 for more configuration options.

The current range and voltage range only applies to CC, CV & CP modes. For CR mode, the voltage range and conductance/resistance ranges are separate from the other modes.

## CR Mode

---

**Description** In Constant Resistance Mode, the unit will maintain a constant resistive load by varying the current. CR mode uses ohms,  $\Omega$  (resistance) or siemens, S (conductance) for the setting units. For more details on CR mode, see the appendix on page 223.

---



### Warning

If you change the mode or the range when the load is already on, the load will be turned off automatically.

---

- Operation**
1. Make sure the load is off.
  2. Press .
  3. Select CR mode with the *Mode[F1]* soft-key.
  4. Select the range with the *Range[F2]* soft-key.  
Range: High, Low
  5. The voltage range will be shown on the *V Range[F3]* soft-key according to the range selected above.
  6. Set the resistance or conductance level parameters using the scroll wheel and number pad.
    - For Static mode, set *CR A Value* and/or *CR B Value*.
    - For Dynamic mode, set *Level1* and *Level2*.
    - The maximum and minimum conductance/resistance levels depend on the selected conductance/resistance range.

7. To add CV mode to CR mode (CR+CV), see page 46.
8. Set the remaining basic configuration settings such as the slew rate and switching mode settings. See page 51 for details.

Display

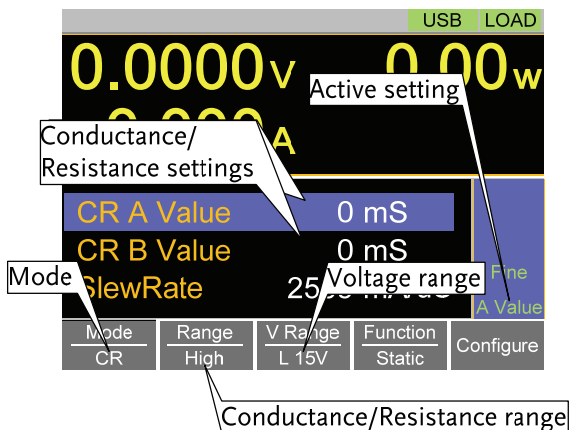

 Note

Basic CR mode configuration is complete. See page 51 for more configuration options.

For CR mode, the voltage range and conductance/resistance ranges are separate from the other modes.

## CR Units

---

**Description** The CR setting units can be set to ohm ( $\Omega$ ) or millisiemens (mS).

---

**Operation**

1. Make sure the load is off.
2. Press  > *Configure*[F5] > *Other*[F2] and set the *CR Unit* setting.  
Range:  $\Omega$ , mS

## CV Mode

---

**Description** In Constant Voltage Mode, the unit will maintain a constant voltage. In CV mode you set the constant voltage level. For more details on CV mode, see the appendix on page 226.

---



If you change the mode or the range when the load is already on, the load will be turned off automatically.

---

**Operation**

1. Make sure the load is off.
2. Press .
3. Select CV mode with the *Mode*[F1] soft-key.
4. Select the current range with the *I Range*[F2] soft-key.  
Range: High, Low
5. Select the voltage range with the *V Range*[F3] soft-key.  
Range: High, Low

6. Set the voltage level parameters using the scroll wheel and number pad.
  - Set CV A Value and/or CV B Value.
  - The maximum and minimum voltage levels depend on the selected voltage range.
7. Set the remaining basic configuration settings such as the response settings. See page 51 for details.

Display

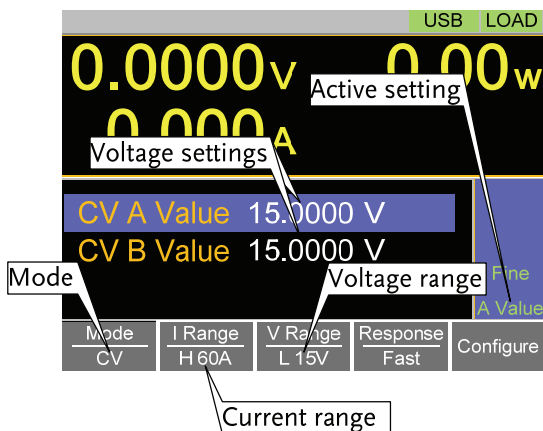

 Note

Basic CV mode configuration is complete. See page 51 for more configuration options.

The current range and voltage range only applies to CC, CV & CP modes. For CR mode, the voltage range and conductance/resistance ranges are separate from the other modes.

## CP Mode

---

**Description** In Constant Power Mode, the unit will maintain a constant power by varying the current. For more details on CP mode, see the appendix on page 224.

---



**Warning**

If you change the mode or the range when the load is already on, the load will be turned off automatically.

---

- Operation**
1. Make sure the load is off.
  2. Press .
  3. Select CP mode with the *Mode[F1]* soft-key.
  4. Select the current range with the *I Range[F2]* soft-key.  
Range: High, Low
  5. Select the voltage range with the *V Range[F3]* soft-key.  
Range: High, Low
  6. Set the power level parameters using the scroll wheel and number pad.
    - Set the CP A Value and/or CP B Value.
    - The maximum and minimum power levels depend on the selected current range.
    - For static mode, the parameter that is set last becomes the “active” setting. This will be shown in the Operation Status Panel.
  7. To add CV mode to CP mode (CP+CV), see page 46.

8. Set the remaining basic configuration settings such as the response settings. See page 51 for details.

Display

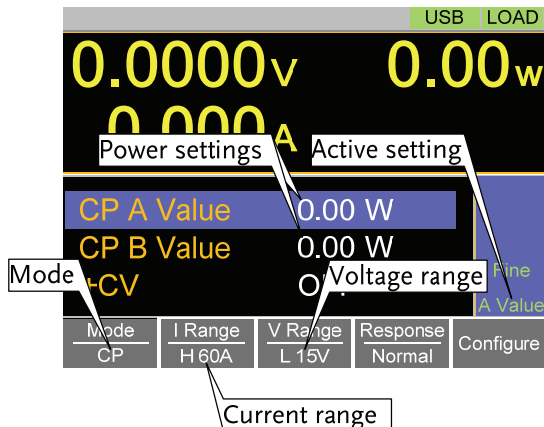

Basic CP mode configuration is complete. See page 51 for more configuration options.

The current range and voltage range only applies to CC, CV & CP modes. For CR mode, the voltage range and conductance/resistance ranges are separate from the other modes.

### +CV Mode

Description

CV mode can be added to CC, CR and CP mode.

- The +CV settings apply to all applicable modes.



- Operation
1. Make sure the load is off.
  2. Press **Main** to return to the main menu for the current mode.
  3. Set the +CV voltage level. (You may need to scroll down to the +CV setting and +CV response speed)  
 Range: OFF - rated voltage+2%  
 +CV setting: Slow, Fast



Note

Ensure the input voltage is greater than the user-defined CV level.

Display

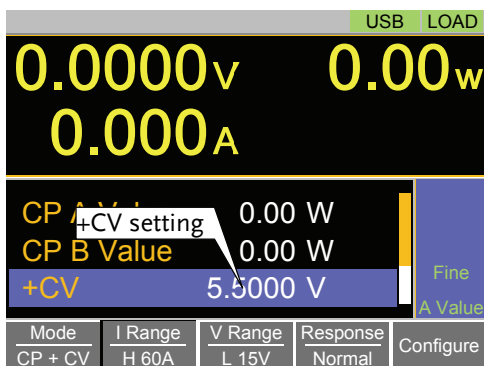

Note

The +CV settings apply to all the applicable operating modes.

For example: The +CV settings made in CR mode will be carried over to the +CV settings in CC and CP mode.





Note

+CV settings cannot be controlled with external control.

## Turning on the Load

---

- Description
1. The load can be turned on and off by pressing the  key.
  - The  key will turn orange when the load is “on”.
  - The LOAD icon in the Main Frame status panel will turn orange when the load is on.
- 



### Note

- The load can be set to automatically turn on at start up. See page 63.
  - The load can be turned on via remote control. See the programming manual.
  - The load can be turned on via external control. See page 192.
  - By default the load will automatically turn off if the range or operating mode (CC, CV, CR, CP) is changed. To disable this behavior, Set *Load Off (Mode)* and *Load Off (Range)* to the *OFF* setting. See page 64 for details.
- 

### Display



## Shorting the Load



---

**Description** The Short key can be used to simulate a short circuit of the load input terminals. A short circuit is simulated by:

- Setting the current to the maximum value in CC mode.
- Setting the resistance to the minimum value in CR mode.
- Setting the voltage to the minimum value in CV mode.
- Setting the power to the maximum value in CP mode.
- When the load is shorted, the external controller also sends a short signal. See page 197 for usage details.

---

**Operation**

1. The short function can be turned on and off by pressing the  key.
- The  key will turn red when the short function is active.
- The Short icon will appear when the short function is active.

**Display**



## Short Key Configuration

**Description**                      The Short key can be configured to Toggle or Hold. By Default the Short key is set to Toggle.

- Toggle: Pressing the Short key will toggle the shorting function on or off.
- Hold: Holding the short key will short the load.



**Operation**

1. Press  > *Configure*[F5] > *Other*[F2] and set the *Short Key* setting.  
Range:    Toggle, Hold

## Locking the Front Panel Controls

**Description**                      The keys and scroll wheel on the front panel can be locked to prevent settings from being changed.

**Operation**

1. The keys can be locked and unlocked by pressing  + .
- LOCK will appear in the Mainframe status panel when the keys are locked.
- The  key will not be locked if the load is on.

**Display**

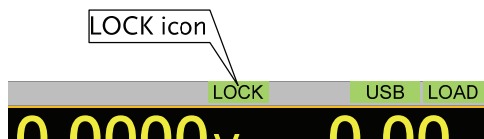

## Basic Configuration

The basic configuration settings are the common configuration settings that are used for each operating mode. After selecting a basic operating mode (CC, CR, CV or CP mode), the slew rate, switching mode, response rate and other common parameters should be configured.

### Select the Switching Function

---

**Description** The PEL-3000E has two switching modes, static and dynamic. The switching modes allow the PEL-3000E to switch between two preset levels. Static mode can only switch between the two levels manually, while Dynamic mode switches between each level automatically based on a timer.

- Static mode: A Value, B Value
- Dynamic mode: Level1, Level2

When the unit is set to static mode, only one value (A Value or B Value) can be active at a time. The active value is shown in the Operation Status Panel.

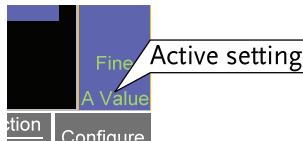

When the unit is set to dynamic mode, the unit will switch between Level1 and Level2 based on the Timer1 and Timer2 parameters, shown below.

---

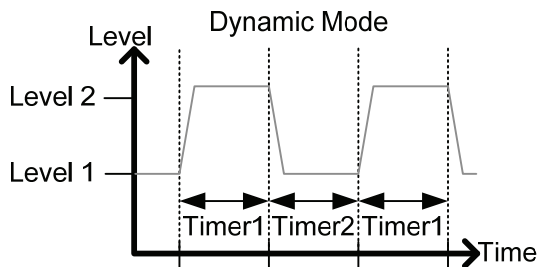

Note

Dynamic mode is not available for CV or CP mode.

Operation

1. Make sure the load is off.
2. Press **Main**.
3. Select Dynamic or Static mode with the *Function[F4]* soft-key.
  - A different switching mode can be set for CC and CR mode.
4. For dynamic mode, set the Timer1 and Timer2 parameters using the scroll wheel and number pad.
  - Timer1 sets the Level1 on-time.
  - Timer2 sets the Level2 on-time.
  - Take the slew rate settings into consideration when setting the timers.
  - The frequency of the dynamic switching is output via the TRIG OUT BNC. See page 65 to turn the trigger on or to configure the trigger.
  - To select whether A Value or B Value is the "active" setting, press the **Shift** + **Preset** keys.

- The “active” value will be shown in the Operation Status Panel.
- The load can be “on” when switching between A Value and B Value.

Display:  
Static Mode

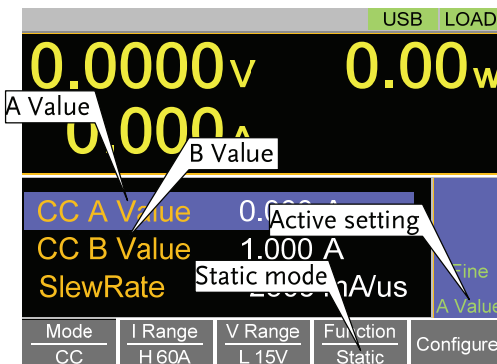

Display:  
Dynamic Mode

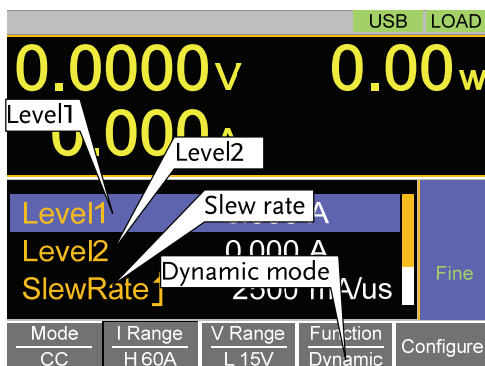

### Select the Display Units for Dynamic Mode Levels

**Description** When Dynamic switching mode is selected, the Level1 and Level2 values can be set to either discrete values or as a percentage of a set value.

- The setting applies to all applicable operation modes.
- By default the units are set to Value.
- When Percent is chosen, 100% = 100% of the Set power, current or resistance value.

**Operation**

1. Make sure the load is off.
2. Press **Main** > *Configure*[F5] > *Other*[F2] and set the *Dyna. Level* setting.  
Range: Value, Percent

**Display:**  
Percent Setting

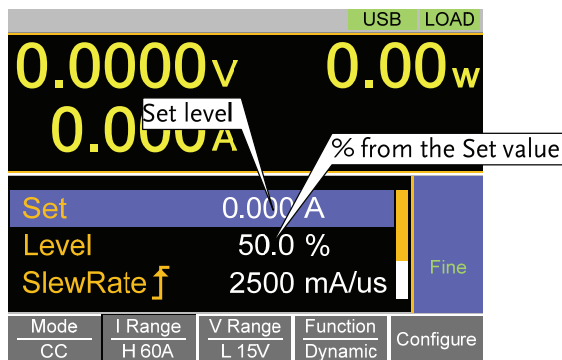



Example

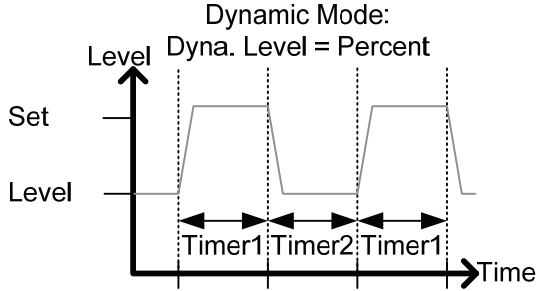

Select the Switching Time Configuration for Dynamic Mode

---

**Description** The switching time for dynamic mode can be configured to switch between two preset on-times (Timer1, Timer2) or by setting a switching frequency and duty cycle.

---

**Operation** 1. Press **Main** > *Configure*[F5] > *Other*[F2] and set the *Dyna. Time* setting.  
Range: T1/T2, Freq. Duty

Slew Rate

---

**Description** The current slew rate can be set for CC and CR mode. The slew rate setting is used to limit the change in current when switching.

For static mode, only a single slew rate can be set.

---

**Operation** 1. Make sure the load is off.  
2. Press **Main**.

3. Set the slew rate(s) using the scroll wheel and number pad.
  - For static mode, only a single slew rate can be set.
  - For dynamic mode, set both the rising and falling slew rates.
  - Take the timer settings into consideration when setting the slew rates.

Display

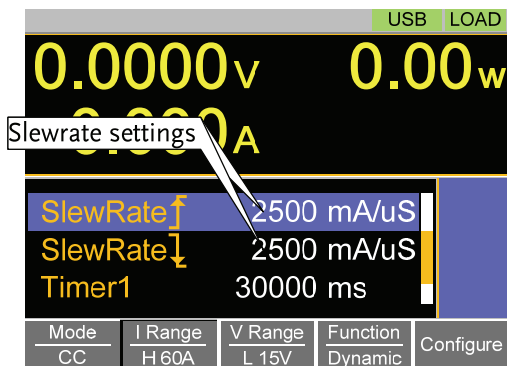

## CV/CP Mode Response Speed

---

Description

The response speed setting is the response speed for the negative feedback control of the load current when used in CV or CP mode. Response speed settings are only applicable to CV or CP mode.

- A response speed that is too fast could cause the unit to be unstable.
  - Reducing the response speed can improve stability.
-

Operation

1. Make sure the load is off.
2. Press **Main**. Make sure the unit is in CV or CP mode by using the *Mode[F1]* soft-key.
3. Select the response speed with the *Response[F4]* soft-key.  
Response: Slow, Normal, Fast

Display

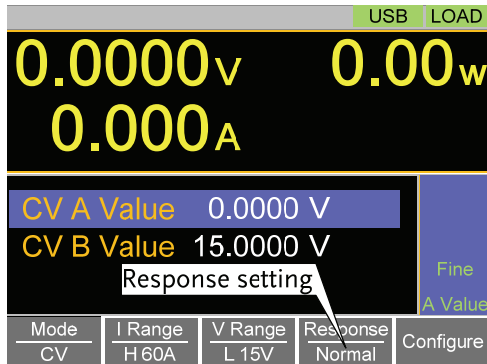

## Advanced Configuration Settings

Use the advanced configuration settings to configure settings other than those described in the basic configuration chapter.

### Soft Start Setting

---

Description

The soft start setting is used to limit the amount of input current at start-up or from when the Von Voltage threshold is tripped.

- The soft start setting only applies to CC, CR and CP mode.

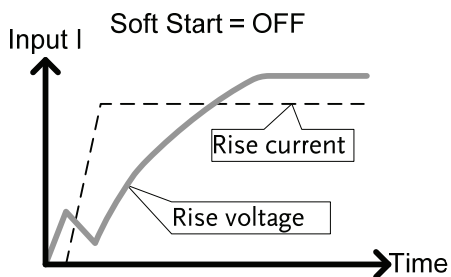
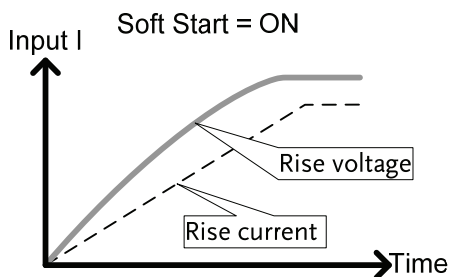

Operation

1. Press **Main** > *Configure*[F5] > *Other*[F2] and set the *Soft Start* time.  
Range: OFF, 1-200ms

## Von Voltage Settings

### Von Voltage Level

---

**Description** The Von Voltage is the threshold voltage at which the load module will start to sink current.

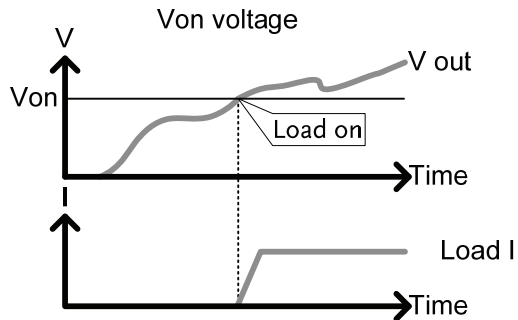

- Operation**
1. Press **Main** > *Configure*[F5] > *Other*[F2] and set the *Von Voltage* level.  
Range: Von Voltage: 0.00-rating voltage

## Von Voltage Latch

### Description

When Von Latch is set to ON, the load will continue to sink current after being “latched”, even if the voltage drops below the Von Voltage threshold level.

When Von Latch is set to OFF, the load will turn off when the voltage drops below the Von Voltage threshold level.

- By default Von Latch is set to OFF.

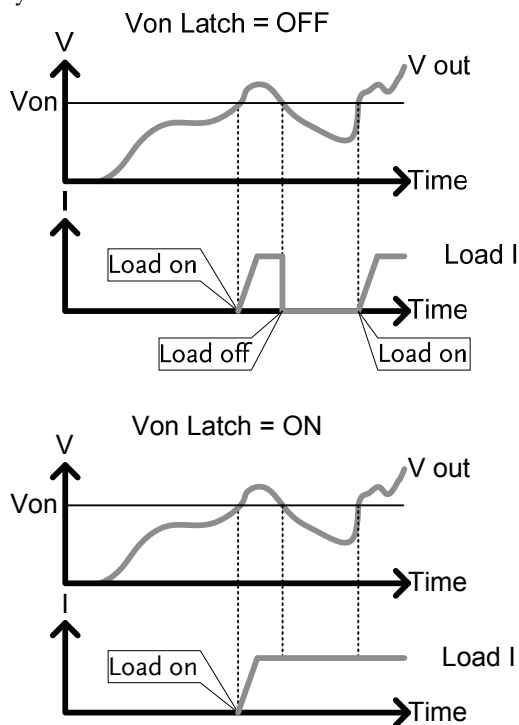

### Operation

1. Press **Main** > *Configure*[F5] > *Other*[F2] and set the *Von Latch* setting.  
Range: Von Latch: OFF, ON

## Von Voltage Delay

---

**Description** Von Delay is the amount of time the unit will wait before turning the load on after the Von Voltage threshold has been latched. This will prevent overshoot current from affecting the Von Voltage threshold.

---

**Operation** 1. Press  > *Configure*[F5] > *Other*[F2] and set the *Von Delay* time.  
Range: Von Delay: OFF, 2.0-60ms

Note: CR mode can have the delay time set separately from the other modes (called *Von Delay –CR* when in CR mode).

## Timer Functions

### Count Time

---

**Description** When Count Time is set to on, it will count the elapsed time from when the load was turned on to when it was turned off.

- This function is applicable to manual and automatic shutdown (such as from protection functions such as UVP etc.)
- The elapsed time will be shown in the display Measurement area.

---

- Operation
1. Press **Main** > *Configure*[F5] > *Other*[F2] and turn the *Count Time* on or off.  
Range: ON, OFF

Display

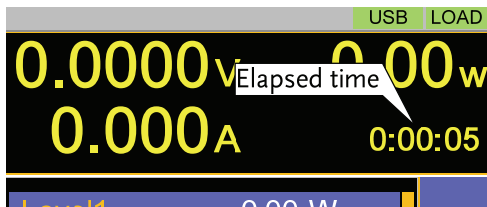

### Cut Off Time

---

Description

The Cut Off Time function will turn the load off after a set-amount of time. After the load has been turned off, a popup screen will display the voltage level when the load was turned off.

- Operation
1. Press **Main** > *Configure*[F5] > *Other*[F2] and set the *Cut Off Time*.  
Range: OFF, 1 second - 999 hours:59 minutes:59 seconds

Display

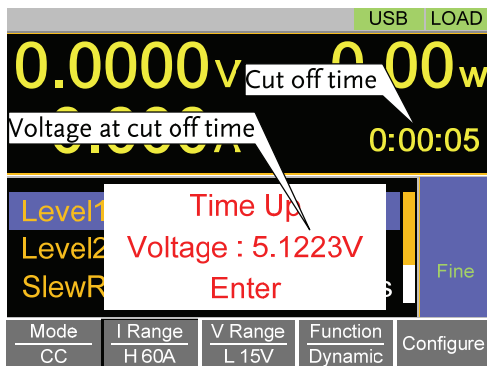





## Auto Load Configuration

---

**Description**                      The PEL-3000E can be configured to automatically load the last program, normal sequence, fast sequence or load setting at startup.

By default, this setting is disabled.

---

- Operation**
1. Press  +  > *Load*[F2].
  2. Turn *Auto Load* On or Off.
    - When set to OFF, the Auto Load setting is disabled.
  3. Select the *Auto Load On* configuration.
    - This will select whether the PEL-3000E will automatically load the last program, normal sequence, fast sequence or load settings.

Auto Load On:      Load, Prog, NSeq, FSeq

## Load Off (Mode) and Load Off (Range)

---



**Description** By default the load will automatically turn off when either the operating mode (CC, CV, CR, CP) or the range (I range, V range) is changed.

To allow the load to stay on when the operating mode is changed, set the *Load Off (Mode)* setting to *OFF*.

To allow the load to stay on when the current or voltage range is changed, set the *Load Off (Range)* setting to *OFF*.

By default, these settings are set to *ON*.

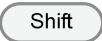
---

- Operation**
1. Press  +  > *Load*[F2].
  2. Select *Load Off (Mode)* setting.
    - When set to *OFF*, the load will stay on when the operating mode is changed.

Load Off (Mode): OFF, ON
  3. Select *Load Off (Range)* setting.
    - When set to *OFF*, the load will stay on when the range is changed.

Load Off (Range): OFF, ON

## Short Safety

---

**Description**                      When activated, the safety short function only allows the short key to be used when the load is already on.

---

**Operation**

1. Press  > *Configure*[F5] > *Other*[F2].
2. Select the *Short (safety)* setting.
  - When set to OFF, the load can be shorted at anytime.
  - When set to ON, the load can only be shorted when the load is already on.

Short (Safety):      OFF, ON

## Short Function Enable/Disable

---

**Description**                      The short key can be disabled to prevent the operator accidentally shorting the load.

---

**Operation**



Press  > *Configure*[F5] > *Other*[F2] and set the *Short Function*.

- When set to OFF, the Short key is disabled and all short configuration options in the Main>Configure>Other menu are also disabled.
- When set to ON, the Short key is enabled.

Short Function:      OFF, ON

## Locking the Front Panel Controls

**Description**                      The keys and scroll wheel on the front panel can be locked to prevent settings from being changed.

- Operation**
- The keys can be locked and unlocked by pressing  + .
    - LOCK will appear in the Mainframe status panel when the keys are locked.
    - The  key will not be locked if the load is on.

**Display**

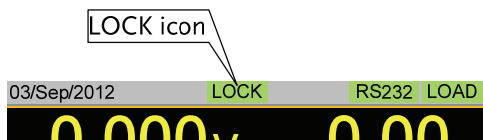

## Input/Output Trigger Settings

See page 199 for more details on the Trigger In or Out BNC terminals. See page 93 & 103 to use the trigger out with the normal or fast sequence function.

### Trigger In Status

---

Description	The Trigger In BNC terminal can be turned on or off.
Operation	1. Press <b>Main</b> > <i>Configure</i> [F5] > <i>Next Menu</i> [F4] > <i>Sync</i> [F1]. Set the <i>Trigger In</i> on or off. Range: ON, OFF(default)

### Trigger In Delay

---

Description	The Trig In Delay setting determines how long to delay any action after a trigger is received.
Operation	1. Press <b>Main</b> > <i>Configure</i> [F5] > <i>Next Menu</i> [F4] > <i>Sync</i> [F1]. Set the <i>Trigger In Delay</i> setting. Range: 0.0 - 5000 $\mu$ s Default: 0 $\mu$ s

### Trigger Out Status

---

Description	The Trigger Out BNC terminal can be turned on or off.
Operation	1. Press <b>Main</b> > <i>Configure</i> [F5] > <i>Next Menu</i> [F4] > <i>Sync</i> [F1]. Set the <i>Trigger Out</i> on or off. Range: ON(default), OFF

## Trigger Out Width

---

**Description**            The Trigger Out Width setting sets the trigger output signal's pulse width.

**Operation**

1. Press **Main** > *Configure*[F5] > *Next Menu*[F4] > *Sync*[F1]. Set the *Trigger Out Width* setting.  
Range:    2.5 - 5000.0 $\mu$ s  
Default: 10 $\mu$ s

## Step Resolution Configuration

There are two different ways to set the set resolution when using the scroll wheel to edit parameters. Step Mode and Cursor Mode. Step Mode is the default method. Only one mode can be active at a time; When one mode is active, the other mode is deactivated.

### Cursor Mode Configuration

**Description** Cursor mode allows you to edit the selected parameter one digit at a time. When editing a parameter, pressing the scroll wheel determines which digit is selected. Turning the scroll wheel will then edit the parameter by the step resolution of the digit.

See the Conventions section on page 29 for operation details.

**Operation** 1. Press **Main** > *Configure*[F5] > *Next Menu*[F4] > *Knob*[F2] and set the *Status* setting is set to *Cursor*.

**Display**

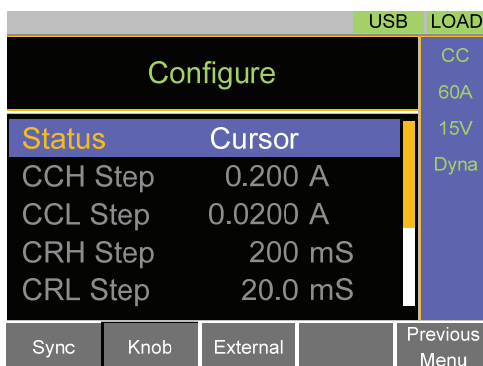

## Step Mode Configuration

**Description** When set to Step Mode, the voltage, current, resistance and power settings can have the step resolution configured. The step resolution refers to the step resolution of the coarse adjustment for these settings. The fine adjustment cannot be configured.

See the Conventions section on page 29 for details on how to switch between coarse and fine adjustment modes.

**Settings** The step resolution of each setting is configured separately for each current range.

Settings	Description
CCH Step	CC mode, IRange = High
CCL Step	CC mode, IRange = Low
CRH Step	CR mode, Range = High
CRL Step	CR mode, Range = Low
CVH Step	CV mode, VRange = High
CVL Step	CV mode, VRange = Low
CPH Step	CP mode, IRange = High
CPL Step	CP mode, IRange = Low



## Operation

1. Press **Main** > *Configure*[F5] > *Next Menu*[F4] > *Knob*[F2] and make sure the *Status* setting is set to *Step*.
2. Set the desired step resolution settings. (The step resolution settings are only available when *Status=Step (coarse/fine)*)
  - For example if the step resolution for CCH Step is 0.200A, then the resolution can be incremented in 0.2A steps.

## Display

		USB	LOAD
Configure			CC
			60A
<b>Status</b>	<b>Step (coarse/fine)</b>		15V
CCH Step	0.200 A		Dyna
CCL Step	0.0200 A		
CRH Step	200 mS		
CRL Step	20.0 mS		
Sync	Knob	External	Previous Menu

## Protection Settings

The Protection settings are used to prevent damage to the unit or the DUT by excessive current, voltage or power.

An alarm is generated and a message is displayed on the screen when a protection setting is tripped. When an alarm is activated, the load is turned off (or limited), and the ALARM STATUS pin of the J1 connector on the rear panel (pin 16) turns on (open collector output by a photocoupler). The protection settings can be used regardless of whether the remote sense connections are used or not.

### OCP

---

Description	<p>For OCP, the PEL-3000E can be configured to either limit the current or turn off the load.</p> <p>The OCP levels can be set to 5% higher than the rating current.</p>
Operation	<ol style="list-style-type: none"> <li>Press <b>Main</b> &gt; <i>Configure</i>[F5] &gt; <i>Protection</i>[F1] and set the <i>OCP Level</i> and <i>OCP Setting</i>.            Range:    <i>OCP Level</i>: Rating current + 5%                          <i>OCP Setting</i>: LIMIT, Load Off, OFF</li> </ol>
Alarm	<ul style="list-style-type: none"> <li>When <i>OCP Setting</i> is configured to <i>Load Off</i>, a message will be displayed on the screen when OCP is tripped. The Enter key must be pressed to clear the alarm message.</li> <li>When configured to <i>LIMIT</i>, OCP will be displayed on the screen when the OCP is tripped and the current will be limited to the <i>OCP Level</i> setting.</li> <li>When configured to <i>OFF</i>, a message will be displayed on the screen when ROCP is tripped. The Enter key must be pressed to clear the alarm message. When configured to <i>OFF</i>, the</li> </ul>

OCP level is automatically fixed (not adjustable) as the rating current + 10% of the currently selected range. For example: If I Range = Low (6A), then OCP level = 6.6A. This setting applies to CC, CV and CP modes.

Display

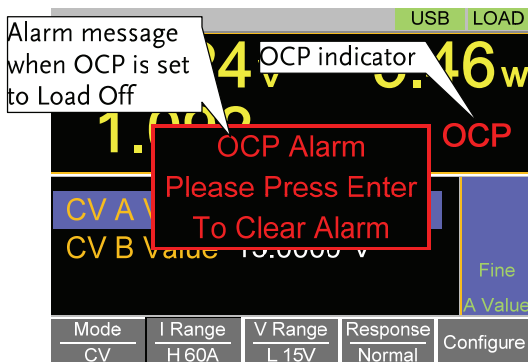

## OPP

Description

For OPP, the PEL-3031E can be configured to either limit the power or turn off the load.

The OPP levels can be set to 5% higher than the rating power.

Operation

1. Press **Main** > *Configure*[F5] > *Protection*[F1] and set the *OPP Level* and *OPP Setting*.  
 Range:    *OPP Level*: Rating power + 5%  
           *OPP Setting*: LIMIT, Load Off, OFF

Alarm

- When *OPP Setting* is configured to *Load Off*, a message will be displayed on the screen when OPP is tripped. The Enter key must be pressed to clear the alarm message.
- When configured to *LIMIT*, OPP will be displayed on the screen when the OPP is tripped and the power will be limited to the *OPP Level* setting.
- When configured to *OFF*, a message will be displayed on the screen when ROPP is tripped. The Enter key must be pressed to clear the alarm message. When configured to *OFF*, the OPP level is automatically fixed (not adjustable) as the rating power + 10%.

Display

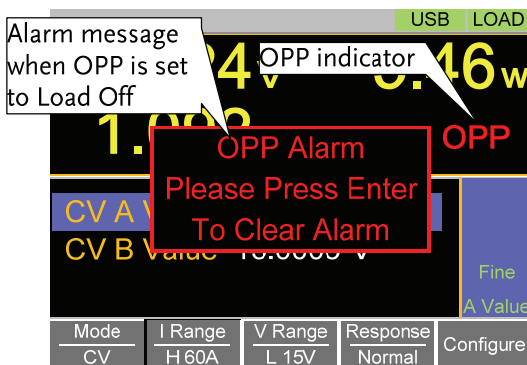

## UVP

---

**Description** If the UVP is tripped, the PEL-3031E will turn off the load.

The UVP levels can be set from 0V to 2% higher than the rating voltage.

**Operation** 1. Press **Main** > *Configure*[F5] > *Protection*[F1] and set the *UVP Level*.

Range: UVP Level: OFF, 0-Rating voltage + 2%

- Alarm**
- The UVP indicator and a message will only appear on the screen when the input voltage is below the UVP level. The Enter key must be pressed to clear the alarm message.
  - To clear the UVP indicator, remove the cause of the under voltage - i.e., increase the input voltage.

**Display**

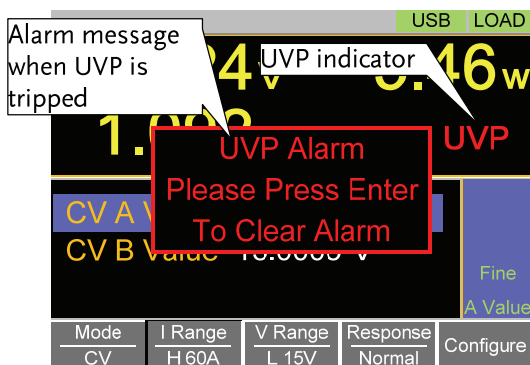

## OVP

**Description** If the OVP is tripped, the PEL-3000E will turn off the load.

The OVP levels can be set from 0V to 5% higher than the rating voltage.

**Operation** 1. Press **Main** > *Configure*[F5] > *Protection*[F1] and set the *OVP Level*.

Range: OVP Level: OFF, 0-Rating voltage + 5%

Note: To turn OVP off, set the OVP voltage greater than the current rating voltage + 5%.

- Alarm**
- The OVP indicator and a message will only appear on the screen when the input voltage is below the UVP level. The Enter key must be pressed to clear the alarm message.
  - To clear the OVP indicator, remove the cause of the over voltage - i.e., reduce the input voltage.

**Display**

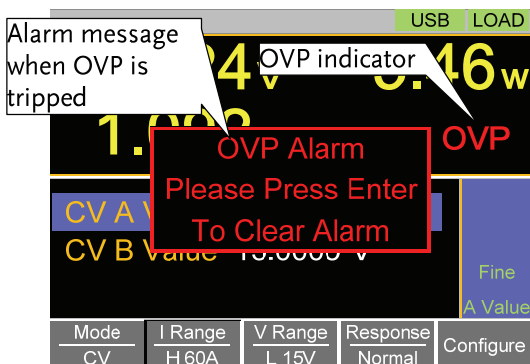

## UnReg

**Description**                      The UnReg error message will appear on the display when the electronic load is operating in an unregulated state.

- Alarm**
- The UnReg indicator will appear on the display when the set load is inadequate for the source.
  - To clear the UnReg indicator, increase the source or reduce the load requirements.

**Display**

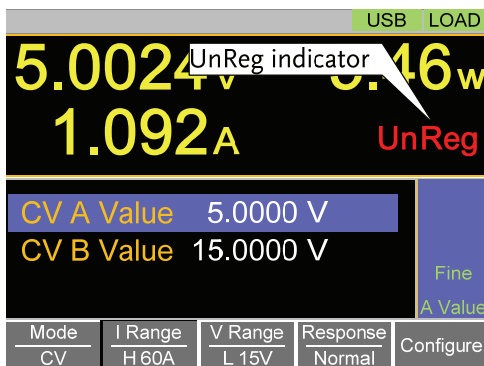

## System Settings

The following section covers a number of miscellaneous system settings such as:

- Speaker settings
- Display settings
- Alarm tone settings
- Input control settings
- Language settings

All system settings are accessible in the Utility menu.



## Sound Settings

### Speaker Settings

---

Description	Turns the speaker sound on or off for the user interface, such as key press tones and scrolling tones.
-------------	--

---

- |           |  |
|-----------|--|
| Operation | <ol style="list-style-type: none"><li>1. Press  +  &gt; <i>Other</i>[F5].</li><li>2. Set the <i>Speaker</i> settings on or off.<ul style="list-style-type: none"><li>• When set to OFF, the speaker setting will not disable the tones for Go-NoGo or protection alarms.</li></ul></li></ol> |
|-----------|--|



## Alarm Tone Settings

---

**Description** The alarm tone for the unit can be turned on or off in the utility menu. The alarm tone can be set separately for the protection settings (OCP, OPP, UVP, OVP), Go-NoGo testing or for when the unit is operating in an unregulated state (see page 77).

---

**Operation**

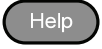
1. Press  +  > *Other*[F5].
2. Set the alarm tone settings on or off.
  - The alarm tone settings ignore the *Speaker* setting.

Alarm Tone: ON, OFF  
 UnReg Tone: ON, OFF  
 Go\_NoGo Tone: ON, OFF

## Display Settings

### Contrast and Brightness

---

**Description** Sets the contrast level.

**Operation**

1. Press  +  > *Other*[F5].
2. Set the *Contrast* and *Brightness* settings.
 

Range: Contrast: 3 - 13 (low - high)  
 Brightness: 50 - 90 (low - high)



## Control Settings

---

**Description**                    The Knob Type setting determines if values are updated immediately as they are edited or if they are only updated after the Enter key is pressed.

The *Updated* setting is applicable for when the load is already on and the user wishes to change the set values (current, voltage, etc.) in realtime.



The *Old* setting will only update the values after the Enter key is pressed.

- Operation**
1. Press  +  > *Other*[F5].
  2. Set the *Knob type* and *Slave knob* settings.  
Range:    Knob type: Updated, Old

## Language Settings

---

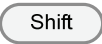
**Description**                    The PEL-3031E supports only English.

- Operation**
1. Press  +  > *Other*[F5].
  2. Set the *Language* setting.  
Supported languages:    English

## Go-NoGo

The Go-NoGo configuration is used to create pass/fail limits on the voltage or current input. If the voltage/current exceeds the pass/fail limits, an alarm will be output.

The Go-NoGo configuration can be used with the Program function to create complex pass/fail tests.

### Setting the Go-NoGo Limits

---

Description	The Go-NoGo setting limits can be set as either discrete high & low values or as a percentage offset from a center value.
-------------	---

Operation	<ol style="list-style-type: none"> <li>1. Press  &gt; <i>Configure</i>[F5] &gt; <i>Go-NoGo</i>[F3].</li> <li>2. Select <i>Entry Mode</i> and choose how to set the pass/fail limits. <ul style="list-style-type: none"> <li>• Value will allow you to set the limits as discrete values.</li> <li>• Percent will allow you to set the limits as a percentage offset from a center value.</li> </ul> </li> <li>3. If <i>Entry Mode</i> was set to <i>Value</i>, Set the <i>High</i> &amp; <i>Low</i> limit values. <ul style="list-style-type: none"> <li>High: 0-rating current/voltage</li> <li>Low: 0 -rating current/voltage</li> </ul> </li> <li>4. If <i>Entry Mode</i> was set to <i>Percent</i>, Set the <i>Center</i> voltage/current and <i>High</i>, <i>Low</i> % values. <ul style="list-style-type: none"> <li>Center: 0-rating current/voltage</li> <li>High: 0-100% of center voltage/current</li> <li>Low: 0-100% of center voltage/current</li> </ul> </li> </ol>
-----------	--

5. Set the *Delay Time*.
  - The delay time setting will delay activating the Go-NoGo testing by a specified amount of time.
  - The delay setting can compensate for startup oscillation and other instabilities during startup.

Delay Time 0.0-1.0 seconds (0.1s resolution)



Note

When the Main settings are saved or recalled, the Go-NoGo settings are also saved/recalled. See the Save/Recall chapter for details, page 112.

## Running a Go-NoGo Test

Description	<p>Go-NoGo test results are displayed in the measurement panel.</p> <ul style="list-style-type: none"> <li>• GO indicates pass (good).</li> <li>• NG indicates fail (no good).</li> </ul>
Operation	<ol style="list-style-type: none"> <li>1. Press  &gt; <i>Configure</i>[F5] &gt; <i>Go-NoGo</i>[F3].</li> <li>2. Set <i>SPEC Test</i> to ON.           <ul style="list-style-type: none"> <li>• When <i>SPEC Test</i> is ON, <i>SPEC</i> will appear in the Operation Status Panel. This means the unit is ready for Go-NoGo testing.</li> </ul> </li> <li>3. Turn the load on.           <ul style="list-style-type: none"> <li>• The test starts from the time the load was turned on + the <i>Delay Time</i>.</li> </ul> </li> </ol>

Display:  
GO

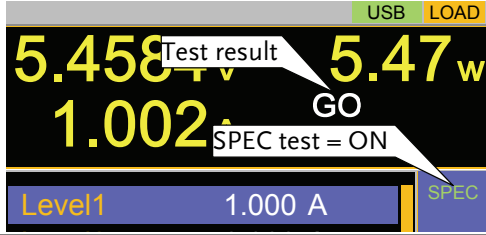

Display:  
NG

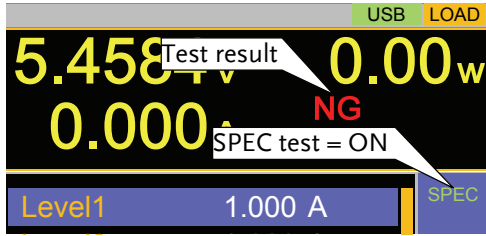

## Program

The PEL-3000E can create programs that are designed to step-through up to 16 pre-set load operations. The program function is a powerful tool that can allow you to perform a number of different operations in succession.

- The execution time of each step is user-defined.
- Programs can be chained together to make larger programs.
- Up to 16 programs can be created for a program chain.

See page 112 for saving load operations.

### Program Overview

---

Description	<p>When you run a program, you are essentially executing up to 16 different load operations consecutively. Each of the different load operations are “steps” in the program. A program starts at step 01 and ends at step 16.</p> <ul style="list-style-type: none"><li>• A program recalls the operating mode, range, static/dynamic mode, response speed and other settings of each step from stored memory. It also recalls the Go-NoGo settings.</li><li>• The same memory settings can be used for multiple steps.</li><li>• The execution time of each step is configurable.</li><li>• Applies the Go-NoGo settings for each step.</li><li>• Each step must be executed in order.</li><li>• Each step can be configured to automatically go to the next step or wait for confirmation from the user before proceeding to the next step.</li><li>• Individual steps can be skipped.</li><li>• Programs can be linked together to make</li></ul>
-------------	--

---

program chains.

- Program chains need not be executed in order.
- There are 16 steps to a program.
- There are up to 16 programs to a chain.

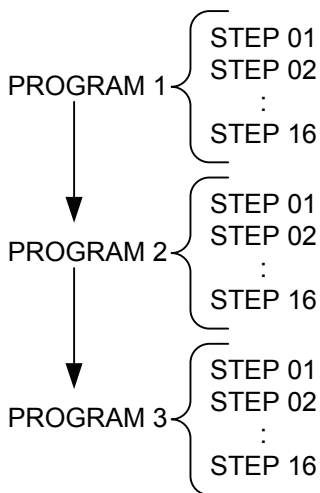

---

#### Setting Overview

A program contains the following settings for each step:

- Memory: the memory location of the load operation for the selected step (M001-M256).
  - Run: Designates the run setting for the step (Auto, Manual, Skip).
  - On-Time: Sets the run time of the test.
  - Off-Time: Sets the off time between steps.
  - P/F-Time: Sets the testing pass/fail delay time for Go/No Go testing.
  - Short-Time: Sets the shorting time for the step, if any.
-

Timing Diagram for Single Step      Below is a timing diagram of a single step in a program.

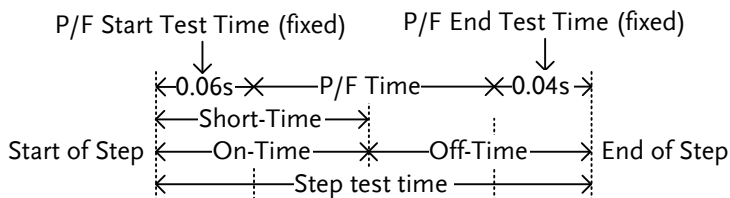

## Create a Program



Note

Before creating a program, the settings for each step must first be created and saved to internal memory (M001-M256). See the save recall chapter for further details, page 112.

Program Setting Display Overview

The screenshot shows the 'Timing Edit for Program' screen. The top section displays 'PROG: 01' and 'STEP: 01'. Below this, the following settings are shown:

Memory	M001	Off-Time:	Off
Run:	Skip	P/F-Time:	Off
On-Time:	0.1	Short-Time:	Off

At the bottom of the screen, there are four buttons: 'Program Off', 'Program settings', 'Recall Default', and 'Program settings'.



## Operation

1. Press **FUNC** > *Program*[F1].
  - Note that *Program*[F1] is off by default.
2. Select *PROG* and select a program number to edit.  
PROG    01 - 16
3. Select a *STEP* in the selected program.  
STEP    01 - 16
4. Select *Memory* and select which memory location to load for the selected step.
  - Settings loaded from the memory location will be used for the selected step.
  - The same memory location can be used for multiple steps.  
Memory   M001 - M256
5. Set the *Run* setting for the step.
  - By default RUN is set to Skip.
  - The Auto setting will automatically start and go onto the next step.
  - The Manual setting will wait for the user to press *Next*[F2] before running the step.  
Run        Skip, Auto, Manual
6. Choose the *On-Time* in seconds.
  - The on-time setting determines how long the load is turned on for the selected step.
  - The on-time is defined as the total test time minus the off-time.  
On-Time   0.1 - 60 seconds

7. Choose the *Off-Time* in seconds.
    - The off-time setting determines how long the load is turned off between the end of the current step and the start of the next step.
    - The off-time is defined as the total test time minus the on-time.  
Off-Time Off, 0.1 - 60 seconds
  
  8. Choose the *P/F-Time* (pass/fail time) in seconds.
    - The P/F-Time refers to the P/F delay time. This delay time includes the 0.06 P/F start test time, as shown in the timing diagram on page 86.  
P/F-Time Off, 0.0 - 119.9 seconds
  
  9. Set the *Short-Time* in seconds.
    - Has the same action as pressing the short key. See page 50 for details about shorting the load.  
Short-Time Off, 0.1 seconds - On-Time
  
  10. Repeat steps 3 to 9 for all the steps in the program.
    - A maximum of 16 steps per program can be created.
    - Steps that are not configured are set to "Skip" by default.
  
  11. Press *Save[F3]* to save the program and all the steps in the program.
    - The program will be saved to internal memory.
    - See the Save/Recall chapter on details on how to save to Setup memory.
-

Recall Default

Pressing *Recall Default*[F4] will recall the default settings for each program/step. See page 217 for details.

## Create a Program Chain



Note

Before creating a program chain, make sure a number of programs have already been saved. These will be used to create the program chain.

Chain Setting  
Display Overview



Operation

1. Press **FUNC** > *Program[F1]* > *Chain[F1]*.
  - It may be necessary to load the programs from Setup memory if they were not created in the current session.
2. If *Start* is not already selected, press *Select Start[F1]* and select which program will be used to start the program chain.
 

Start:     P01 - P16
3. Select *P01* and choose which program will be linked to P01.
  - Selecting OFF will end the chain after P01.
  - Selecting P01 will create an infinite chain.
  - Chains need not be linked in sequential order.
 

P01:     OFF, P01 - P16

4. Repeat step 3 for any remaining programs in the chain.
  5. Press *Save* to save the program chain to internal memory.
- 

Pressing *Recall Default*[F4] will reset the chain to the default settings. See page 217 for details.

- Recall Default[F4] will essentially clear the program chain.

## Running a Program or Chain

---

Description	A program or program chain is run the same way as a normal load.
Operation	<ol style="list-style-type: none"> <li>1. Press  &gt; <i>Program</i>[F1].</li> <li>2. Turn program mode on by setting <i>Program</i>[F1] to On. <ul style="list-style-type: none"> <li>• <b>PROG</b> will appear at the top of the display when <i>Program</i> is On.</li> </ul> </li> <li>3. Turn the load on. <ul style="list-style-type: none"> <li>• The program/chain starts immediately.</li> <li>• The <b>PROG</b> icon turns orange when the load is turned on.</li> </ul> </li> <li>4. When a program/chain is running the screen displays which program, step and memory is currently active. <ul style="list-style-type: none"> <li>• Press <i>Pause</i>[F1] to suspend a test, press <i>Continue</i>[F1] to resume.</li> <li>• Press <i>Next</i>[F2] to run the next step if its <i>Run</i> setting was set to <i>Manual</i>.</li> </ul> </li> </ol>

5. When a program/chain has finished running, a list of the Go-NoGo results for each step are displayed.
  - Press *Exit*[F5] to exit.

Display:  
Program/Chain  
Running

The screenshot shows a black display with yellow and white text. At the top right, 'USB' and 'PROG' are displayed in green. The main display area shows:
 

- 0.0000v (yellow)
- 0.00w (yellow)
- 0.000A (yellow)
- Run Program (white)
- Program No: 01 (white)
- Step(Memory) 01(001) GO (white)

 Callouts with white boxes and black text point to:
 

- '01' in 'Program No: 01' with the text 'Program number that is currently running.'
- '01(001)' in 'Step(Memory) 01(001) GO' with the text 'Step that is currently running.'
- 'GO' in 'Step(Memory) 01(001) GO' with the text 'No-NoGo result for the step'.
- '01(001)' in 'Step(Memory) 01(001) GO' with the text 'Memory number of current step.'

Display:  
Program/Chain  
Finished

The screenshot shows a black display with green and white text. At the top right, 'USB' and 'PROG' are displayed in green. The main display area shows:
 

- Run Program Detail Result (green)
- Table with 3 columns: Program, Step, Result
- Row 1: 1, 1, GO
- Row 2: 1, 2, GO
- Row 3: 1, 3, NG

 At the bottom right, there is a grey button labeled 'Exit'.

Program	Step	Result
1	1	GO
1	2	GO
1	3	NG

## Sequence

The PEL-3000E supports both programs and sequences. The essential difference between programs and sequences is that programs can use different operating modes for each step while sequences use the same operating mode throughout the whole sequence. In effect sequences are used to create complex load simulations.

There are two different types of Sequences, Normal Sequences and Fast Sequences.

Normal sequences can define the execution time and slew rate of each step.

On the other hand the execution time for each step in a fast sequence is fixed to the rate (Time Base setting) set by the user.

### Normal Sequence Overview

---

Description	<p>A normal sequence is comprised of a user-defined number of steps that when executed in sequence can be used to simulate a DC load.</p> <ul style="list-style-type: none"><li>• Up to 1000 discrete steps can be configured using normal sequences.</li><li>• Each normal sequence can have a memo note attached to it.</li><li>• Normal Sequences can be looped up to 9999 discrete times or for an infinite amount of times.</li><li>• Normal sequences can be configured to hold a set voltage, current, power or resistance at the end of the load.</li><li>• Normal Sequences can be linked together in a chain.</li></ul>
-------------	---

---

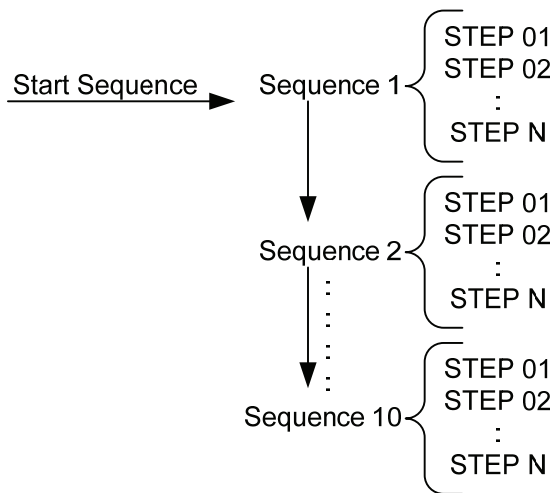

**Description**

Normal Sequence configuration is split into Timing Edit configuration and Data Edit configuration.

Timing Edit configuration is used to configure the actual sequences, such as mode, range, loops and chains.

Data Edit configuration is used to create the actual steps used in each sequence.

See below for a description of each.

**Timing Edit Overview**

A Normal Sequence contains the following timing settings for each sequence:

Setting	Setting Range	Description
Start	S01 - S10	Sets which sequence is used to start a chain of Normal Sequences.
Seq.No	S01 - S10	Sets the current sequence to edit.



Memo	12 characters	A user-created note for the currently selected sequence.
Mode	CC, CR, CV, CP	Operating mode for the sequence. +CV mode is supported.
Range	ILVL	Low I range, low V range
	IHVL	High I range, low V range
	ILVH	Low I range, high V range
	IHVH	High I range, high V range
	SLVH	Low S range, high V range
	SHVL	High S range, low V range
Loop	Infinite, 01 - 9999	Sets the amount of times to loop the selected sequence.
Last Load	OFF, ON	Set the load condition after the end of the sequence. Not available when Loop=Infinite.
Last	Value	The setting value of the load for when Last Load = ON. Not available when Loop=Infinite.
Chain	Off, S01-S10	Sets the next sequence in the chain, when not set to off. Not available when Loop=Infinite.

Data Edit Overview Each step in a normal sequence contains the following setting parameters:

Setting	Setting Range	Description
Step	0001 - 1000	Selects/displays the current step in the sequence. <ul style="list-style-type: none"> <li>The number of available steps is dependent on the number of steps added using the <i>Insert Point</i>[F1] functions.</li> </ul>

Value		The current, voltage, power or resistance setting for the selected operating mode.
Load	ON, OFF	Turns the load on or off for the selected step.
RAMP	ON, OFF	When turned on the current transition is evenly ramped from the start of the step to the end of the step. When turned off the current transition is stepped.

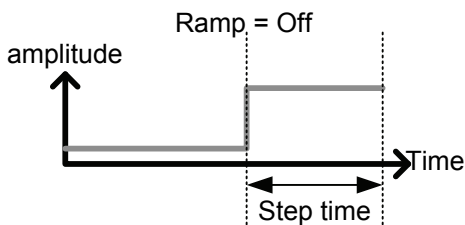
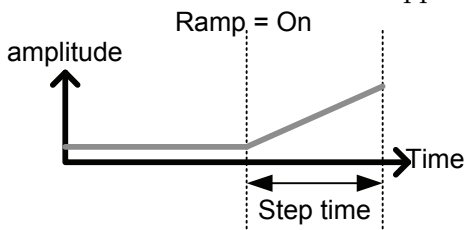

TRIG OUT	ON, OFF	When TRIG OUT is set to ON, a trigger signal is output from the TRIG OUT BNC terminal at the start of the step. See page 65, 199 for details.
----------	---------	---

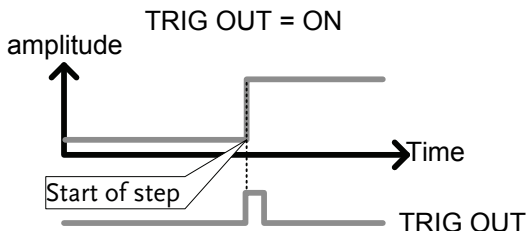

---

PAUSE	ON, OFF	Pause: Inserts a pause at the end of the step. When paused, the unit will pause at the end of the step current/voltage/resistance/power level. The sequence can be resumed by pressing <i>Next[F2]</i> or by using the TRIG IN BNC terminal (page 199).
-------	---------	---

---

## Timing Edit Configuration

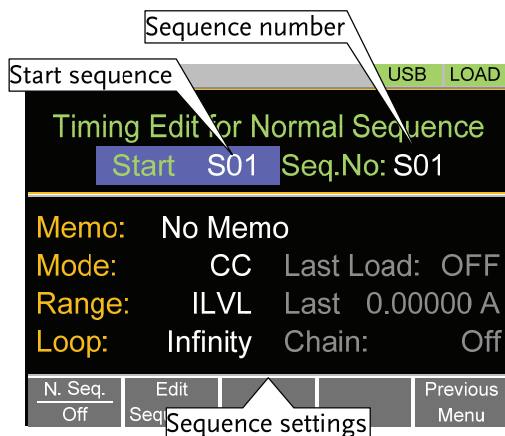
Edit Timing  
Display

Operation

1. Press **FUNC** > *Sequence[F2]* > *Normal Sequence[F1]*.
  - Note that *N. Seq.[F1]* is off by default.
2. Select *Start* and select the number of the starting sequence.
 

Start: S01 - S10
3. Select a *Seq. No.* and select which sequence to edit.
 

Seq. No.: S01 - S10
4. Set the following parameters for the currently selected sequence. See page 93 for details on each parameter.
  - Memo
  - Mode
  - Range
  - Loop

- Last Load
  - Last
  - Chain
5. Press *Save*[F3] to save the timing settings for the currently selected sequence.

Sequence Timing configuration is complete.

- Go to Data Edit to edit the steps used in the Normal Sequences. See page 99.
- Go to Running a Normal Sequence to run the normal sequence. See page 101.

## Data Edit Configuration

### Data Edit Display

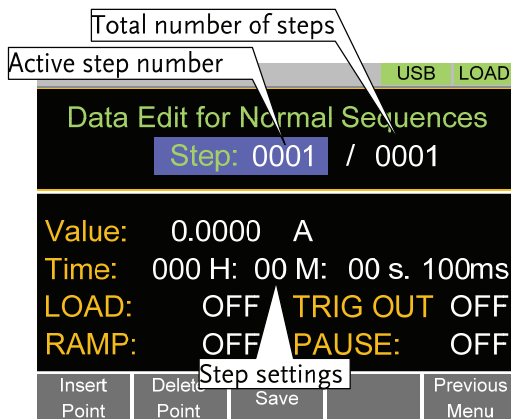

### Operation

1. Press **FUNC** > *Sequence*[F2] > *Normal Sequence*[F1].
2. Select *Seq.No.* and select the sequence you wish to edit.  
Seq No.: S01 - S10
3. Press *Edit Sequence* [F2] to enter the Data Edit

configuration menu.

- Note that when there are no steps in the current sequence the Data Edit for Normal Sequence settings are blank.
4. Press *Insert Point*[F1] to add a step to the sequence after the current step.
    - Every time *Insert Point* is pressed the *Step* parameter is incremented.
    - The inserted point becomes the current step.
  5. Set the following parameters for the currently selected step. See the Data Edit Overview on page 95 for configuration details.
    - Value
    - Time
    - LOAD
    - RAMP
    - TRIG OUT
    - PAUSE
  6. If you wish to edit a previously inserted point/step, use the *Step* parameter.
    - Steps can only be selected after they have already been inserted.  
Steps        0001 - 1000
  7. The currently selected step can be deleted using the *Delete Point*[F2] function.
  8. After all the steps for the sequence are complete, press *Save*[F3] to save the steps.

Data Edit for Normal Sequence configuration is complete.

- Go to Timing Edit for Normal Sequences to edit the sequence. Page 98.
- Go to Running a Normal Sequence to run the normal sequence. Page 101.

## Running a Normal Sequence

Description	A load created with the Normal Sequence function is run the same way as a normal load.
Operation	<ol style="list-style-type: none"> <li>1. Press <b>FUNC</b> &gt; <i>Sequence[F1]</i> &gt; <i>Normal Sequence [F1]</i>.</li> <li>2. Turn normal sequence mode on by setting <i>N. Seq.[F1]</i> to <i>On</i>. <ul style="list-style-type: none"> <li>• <b>NSEQ</b> will appear at the top of the display when <i>N. Seq.</i> is <i>On</i>.</li> </ul> </li> <li>3. Turn the load on. <ul style="list-style-type: none"> <li>• The normal sequence/chain starts immediately.</li> <li>• The <b>NSEQ</b> icon turns orange when the load is turned on.</li> </ul> </li> <li>4. When a normal sequence/chain is running, the screen displays which sequence, step and loop are currently active. <ul style="list-style-type: none"> <li>• Sequences can be paused by pressing <i>Pause[F1]</i> and resumed again by pressing <i>Continue[F1]</i>.</li> <li>• If no steps have been created “No N.Seq.” will be displayed on the screen.</li> <li>• “<i>Sequence Complete</i>” will be displayed at the end of the sequence.</li> </ul> </li> </ol>

Display:  
Sequence/Chain  
Running

		USB	NSEQ
<b>5.4540v</b>		<b>5.619w</b>	
<b>1030.2mA</b>			
Run N.Seq.	Seq. No:	01	
	Step	0003	
	Loop:	0001	
Continue			



## Fast Sequence Overview

---

- Description
- A fast sequence is comprised of a user-defined number of steps that can be executed at a high frequency. Unlike normal sequences, each step in a fast sequence has the same execution time (time base).
- This mode is only available for CC and CR mode.
  - Up to 1000 discrete steps can be configured using fast sequences.
  - Each fast sequence can have a memo note attached to it.
  - Fast Sequences can be looped up to 9999 discrete times or for an infinite amount of times.
  - Fast sequences can be configured to hold a set current or resistance at the end of the load.
  - No ramping function can be used with the Fast Sequence function.

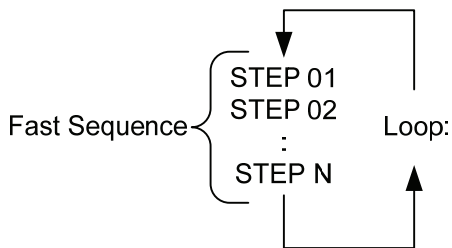

**Description** Fast Sequence configuration is split into Timing Edit configuration and Data Edit configuration.

Timing Edit configuration is used to configure all the settings that are common to all the steps of the fast sequence. This includes settings such as the mode, range, loops and time base.

Data Edit configuration is used to create the actual steps used in each sequence.

See below for a description of each.

**Timing Edit Overview** A Fast Sequence contains the following timing settings for each sequence:

Setting	Setting Range	Description
Memo	12 characters	A user-created note for the currently selected sequence.
Mode	CC, CR	Operating mode for the sequence.
Range	ILVL	Low I range, low V range
	IHVL	High I range, low V range
	ILVH	Low I range, high V range
	IHVH	High I range, high V range
	SLVH	Low S range, high V range
	SHVL	High S range, low V range
Loop	Infinity, 01 - 9999	Sets the amount of times to loop the selected sequence.
Last Load	OFF, ON	Set the load condition after the end of the sequence.
Last	0.000000	The load setting for when Last Load is set to ON.
RPTSTEP	0001 - 1000	Last step number (0001-1000) per loop.
Time Base	0.025 - 600ms	Sets the step execution time.

Data Edit Overview Each step in a fast sequence contains the following setting parameters:

Setting	Setting Range	Description
Step	0001 - 1000	<p>Selects/displays the current step in the sequence.</p> <ul style="list-style-type: none"> <li>The number of available steps is dependent on the number of steps added using the <i>Ins. Point[F1]</i> functions.</li> <li>A minimum of 3 steps.</li> </ul>
Value		The current or resistance setting for the selected operating mode.
TRIG OUT	ON, OFF	When TRIG OUT is set to ON, a trigger signal is output from the TRIG OUT BNC terminal at the start of the step. See page 199 for details.

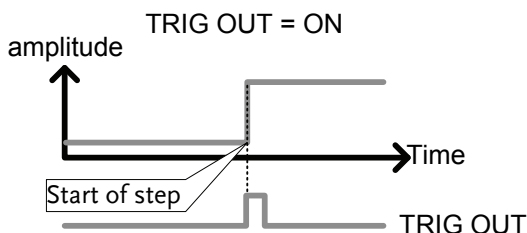

FILL Overview The FILL function is used to evenly step up the current or resistance value settings from a starting step to a finishing step.

The Fill Function can be used before or after points are added to the fast sequence.

- Before: Will pre-fill each value within the fill range when a new step is added.

- After: Will post-fill each value within the fill range.

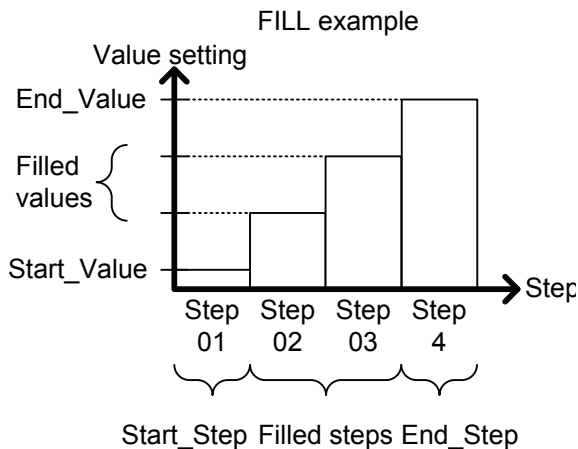

Setting	Setting Range	Description
Start_Value		Sets the current or resistance value for the starting step.
End_Value		Sets the current or resistance value for the ending step.
Start_Step	0001 - 1000	Sets the starting step number.
End_Step	0001 - 1000	Sets the ending step number.

## Timing Edit Configuration

Edit Timing  
Display

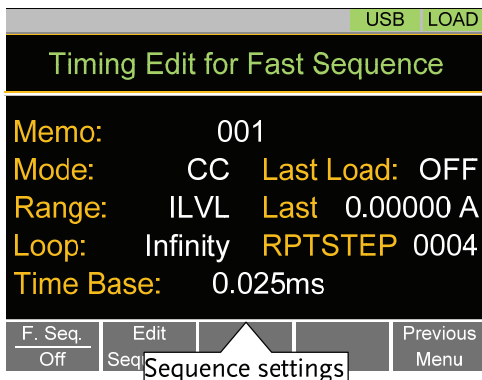

Operation

1. Press **FUNC** > *Sequence[F2]* > *Fast Sequence[F2]*.
  - Note that *F. Seq.[F1]* is off by default.
2. Set the following parameters for the fast sequence. See page 104 for details on each parameter.
  - Memo
  - Mode
  - Range
  - Loop
  - Last Load
  - Last
  - RPTSTEP
  - Time Base

Save

Press *Save[F3]* to save the timing settings for the fast sequence.

Sequence Timing configuration is complete.

- Go to Data Edit to edit the steps used in the Fast Sequence. Page 108.
- Go to Running a Fast Sequence to run the fast sequence. Page 110.

## Data Edit Configuration

### Data Edit Display

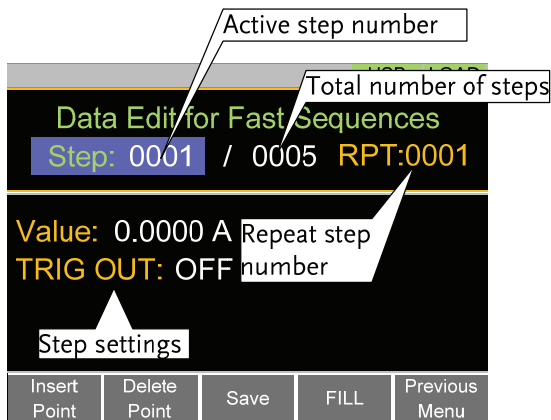

### FILL Display

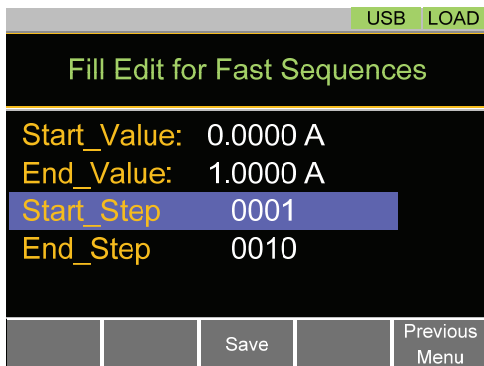

### Operation

1. Press **FUNC** > *Sequence*[F2] > *Fast Sequence*[F2] > *Edit Sequence*[F2] to enter the Data Edit configuration menu.
2. Press *Insert Point*[F1] to add a step to the

sequence.

- Every-time *Insert Point* is pressed the *Step* parameter is incremented.
  - The newly inserted “point” becomes the active step.
3. Set the following parameters for the currently selected step. See page 107 for configuration details.
    - Value
    - TRIG OUT
  4. If you wish to edit a previously added point/step, use the *Steps* parameter.
    - Steps can only be selected after they have already been added.  
Steps        0001 - 1000(RPTSTEP)
  5. The currently selected step can be deleted using the *Delete Point[F2]* function.
    - There cannot be less than 3 steps for fast sequences.

Fill Function        Press *FILL[F4]* to use the fill function. Set the fill parameters:

- Start\_Value
- End\_Value
- Start\_Step
- End\_Step

The fill function can be used any number of times.

Save                    After all the steps for the sequence are complete, press *Save[F3]* to save the steps.

Data Edit for Fast Sequences configuration is complete.

- Go to Timing Edit for Fast Sequences to edit the sequence. Page 107.
- Go to Running a Fast Sequence to run the fast sequence. Page 110.

## Running a Fast Sequence

---

**Description** A Fast Sequence is run the same way as a normal load.

---

- Operation**
1. Press **FUNC** > *Sequence[F2]* > *Fast Sequence[F2]*.
  2. Turn fast sequence mode on by setting *F. Seq.[F1]* to *On*.
    - **FSEQ** will appear at the top of the display when *F. Seq.* is *On*.
  3. Turn the load on.
    - The fast sequence/chain starts immediately.
    - The **FSEQ** icon turns orange when the load is turned on.
  4. When a fast sequence is running, the screen displays which step and loop is currently active.
    - “*Sequence Complete*” will be shown on the display at the end of the sequence.
-



Display:  
Fast Sequence  
Running

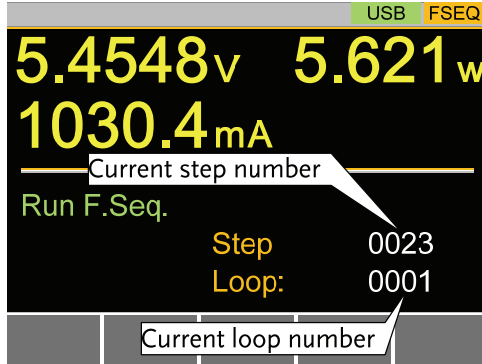

## Save Recall

The PEL-3000E can save and recall system settings, preset data, memory data, Go-NoGo settings as well as normal and fast sequences to internal memory or to USB.

### File Structure

---

#### Description

The PEL-3000E file system can save files to internal memory (Media | Memory) and external memory (Media | USB).

To save or recall Memory, Setup or Preset data, the PEL-3000E uses a three tier system where files are saved or recalled in the following order:

Active settings <> Internal memory <> USB.

This can be best described in the picture below.

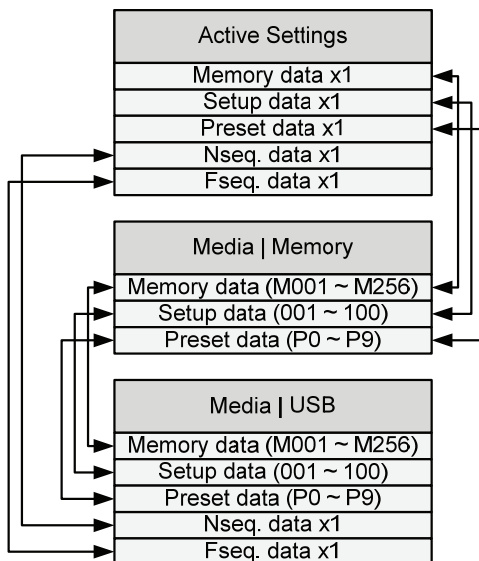

For example:

To load Preset Data P7 from USB, you must first load Preset Data P0-P9 to internal memory, then from internal memory load Preset P7 to be the active preset setting.

For normal and fast sequences however, files can be saved or recalled directly to/from USB memory.

---

## File Types

### Memory Data

Memory data contains general settings and is used for creating programs. Memory Data contains the operating mode, range, response and Go/NoGo settings. Memory data can be stored both internally and externally to USB. Preset data and Memory data store the same contents.

---

	Internal Format M001 - M256
	External Format model no._file no.M example:3000E_01.M
Setup Data	Setup data contains all general configuration settings, protection settings, program and program chain settings.
	Internal Format 1 - 100
	External Format model no._file no.S example:3000E_00.S
Preset Data	Preset Data contains the same settings as the Memory Data. Preset Data contains the operating mode, range, response and Go-NoGo settings.
	Internal Format P0 - P9
	External Format model no._file no.P example: 3000E_00.P
NSeq Data	NSeq Data contains the Normal Sequence settings.
	Internal Format None
	External Format model no._file no.N example: 3000E_00.N
FSeq Data	FSeq Data contains the Fast Sequence settings.
	Internal Format None
	External Format model no._file no.F example:3000E_00.F

---

## Saving Files to Internal Memory

**Description** When saving Memory, Setup or Preset Data to internal memory, the currently active setting is saved to one of the internal memory slots.

Memory Data has 256 memory slots, Setup Data has 100 memory slots and Preset Data has 10 memory slots.

**Memory Data Example**

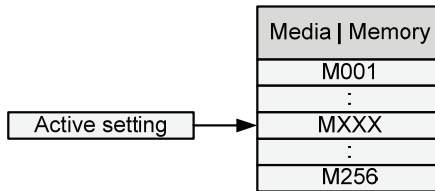

**Display**

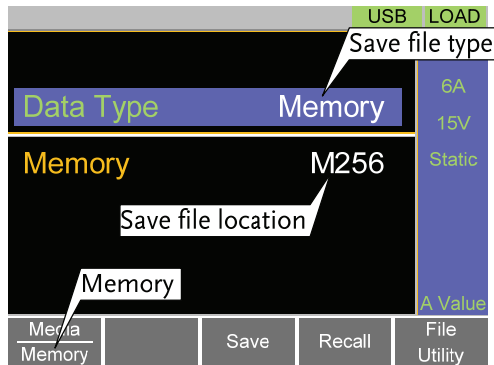

**Operation**

1. Press **Shift** + **FUNC** .
2. Select Memory with the *Media[F1]* soft-key.
3. Select the *Data Type* and choose the type of file to save.  
 Data Type: Memory Data, Setup Data, Preset Data

4. Select which internal memory location to save the file.

Memory: M001 - M256

Setup Memory: 1 - 100

Preset: P0 - P9

5. Press *Save*[F3] to save.

- Save Ok will be displayed when the save has been completed.



Note

Normal Sequence and Fast Sequence data cannot be recalled from or saved to an internal memory slot.

### Saving Files to USB Memory

Description

When saving files to USB memory, all the memory locations from the selected data type are saved as a single file to the USB file path directory.

Memory Data Example

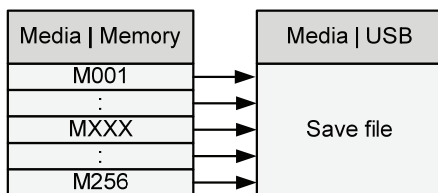

For example, Memory Data M001 to M256 are saved to a single file on USB.

Display

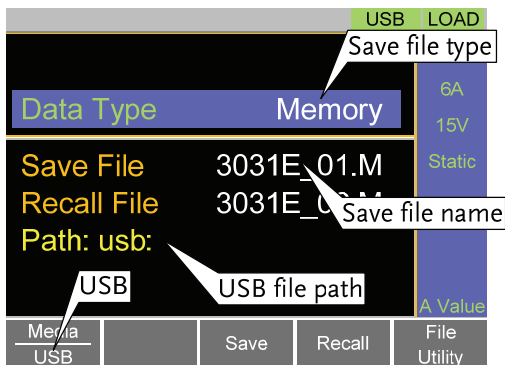

Operation

1. Insert a USB drive into the USB port.

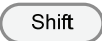
2. Press  + .

3. Select USB with the *Media[F1]* soft-key.

4. Select the *Data Type* and choose the type of file to save.

Data Type: Memory Data, Setup Data,  
Preset Data, NSeq, FSeq

5. Select *Save File* and choose a save filename.

- Turn the scroll wheel to increase/decrease the file number.

Memory:            model no.\_file number.M  
Setup Memory:    model no.\_file number.S  
Preset:            model no.\_file number.P  
NSeq:              model no.\_file number.N  
FSeq:              model no.\_file number.F

6. Press *Save*[F3] to save.
    - The file will be saved to the USB file path.
    - Save Ok will be displayed when the save has been completed.
    - If saving-over an existing file you will be asked to confirm the save. Press *Save*[F3] to confirm.
- 

**File Utilities**

Press *File Utility*[F5] to access the file utility.  
See page 123 for details.

- Change the USB path.
- Rename files or create directories.



## Recalling Files from Internal Memory

**Description** When recalling Memory, Setup or Preset Data from the internal memory slots, the recalled file becomes the active setting.

Memory Data has 256 memory slots, Setup Data has 100 memory slots and Preset Data has 10 memory slots.

**Memory Data Example**

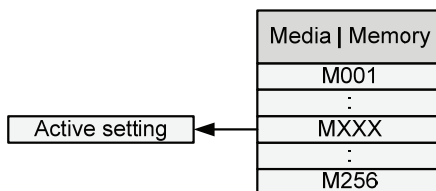

**Display**

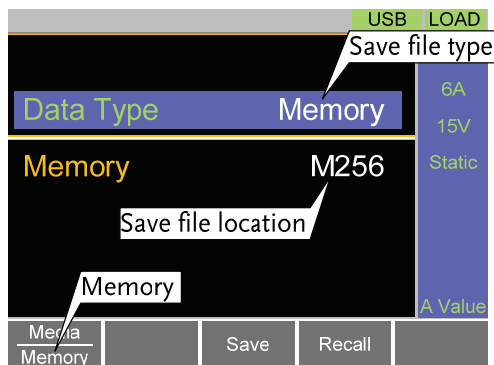

**Operation**

1. Press **Shift** + **FUNC** .
2. Select Memory with the *Media[F1]* soft-key.
3. Select the *Data Type* and choose the type of file to recall.  
Data Type: Memory Data, Setup Data, Preset Data

4. Select which memory slot to recall from.
  - Memory: M001 - M256
  - Setup Memory: 1 - 100
  - Preset: P0 - P9
  
5. Press *Recall*[F4] to recall.
  - For Memory Data and Preset Data, a popup window will appear. Press the  key to confirm the recall.



Note

Normal Sequence and Fast Sequence data cannot be recalled from or saved to an internal memory slot. They can, however, be recalled directly from USB memory. See the next section below for details.

### Recalling Files from USB Memory

**Description** When recalling Memory, Setup or Preset files from USB memory, a single file from the USB drive will overwrite all the existing memory slots for the selected data type.

For Normal or Fast Sequence files, the recalled file becomes the active setting as these types of files don't have an internal memory slot.

**Memory Data Example**

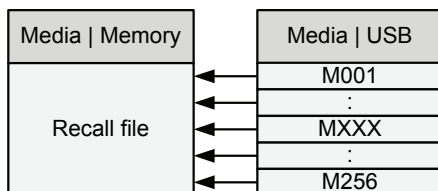

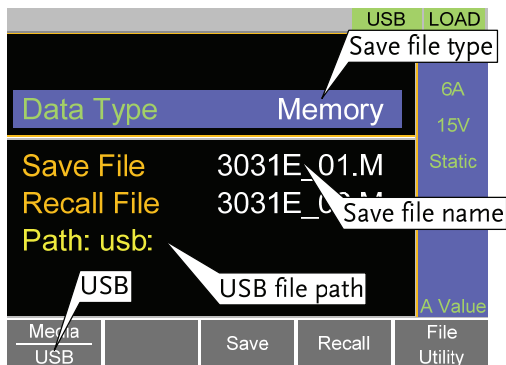

For example, if the file 3000E\_01.M is recalled, all the Memory Data from M001 to M256 will be overwritten.

Display



Operation

1. Insert a USB drive into the USB port.
2. Press  +  (File).
3. Select *USB* with the *Media[F1]* soft-key.
4. Select the *Data Type* and choose the type of file to recall.  
Data Type: Memory Data, Setup Data, Preset Data, NSeq, FSeq
5. Select *Recall File* and choose a filename.
  - Turn the scroll wheel to increase/decrease the file number.  
Memory:            model no.\_file number.M  
Setup Memory:    model no.\_file number.S  
Preset:             model no.\_file number.P  
NSeq:                model no.\_file number.N  
FSeq:                model no.\_file number.F
6. Press *Recall[F4]* to recall.
  - Recall Ok will be displayed when the recall has been completed.

File Utilities Press *File Utility*[F5] to access the file utility. See page 123 for details.

- Change the USB path.
- Rename files or create directories.



Caution

If “Machine Type Error” is displayed it indicates that the file that you are trying to recall originated from a different model. You can only recall files from the same model.

## Recall Memory Safety Setting

---

Description By default when you try to recall *preset settings* from internal memory, a message will appear asking you to press the Enter key to confirm. This is the standard safety measure to ensure that the wrong setting is not recalled. This safety measure can be disabled by setting the Mem. Recall setting to “Direct”.

Operation 1. Press  > *Configure*[F5] > *Other*[F2] and set the *Mem. Recall* setting.

Range: Safety, Direct



Note

This setting only applies when recalling preset settings from internal memory, either by using the Presets keys (P0 - P9) or by using the File menu. See page 125 and 119.

## File Utility

---

**Description** The file utility allows you to create new folders, rename files and set the USB path directory.

It is only available for use with the USB external memory.

---

**Display**

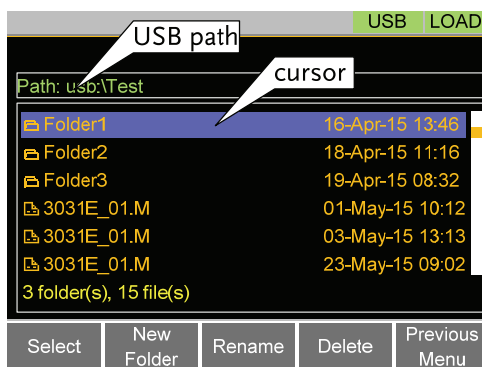

**Access the File Utilities Menu**

1. Insert a USB drive into the USB port.
  2. Press **Shift** + **File FUNC** > *File Utility*[F5].
    - The file utilities screen appears.
- 

**Create a new Folder**

1. Press *New Folder*[F2] to create a new folder.
    - Use the on-screen display to enter the filename.
    - A maximum of 8 characters.
-

- Rename a Folder
1. Use the scroll wheel to move the cursor to the file/folder you wish to rename.
  2. Press *Rename*[F3].
    - Use the on-screen display to enter the filename.
    - A maximum of 8 characters.
- 

- Delete File or Folder
1. Use the scroll wheel to move the cursor to the file/folder you wish to delete.
  2. Press *Delete*[F4].
  3. Press *Delete*[F4] again to confirm the deletion.

## Preset



The Preset key is used to save and recall preset settings from the front panel quickly. The presets have the same contents as memory data, this includes the operating mode, range, configuration settings and Go-NoGo settings.

## Quick Preset Save

---

Description                      The current settings can be saved to P0 - P9 using the Preset key and the number pad.

---





- Operation
1. Press  and hold  -  until a beep is heard.
    - The beep indicates that the setting was saved to the selected preset.

## Quick Preset Recall

---

Description Presets P0 to P9 can be recalled quickly by using the Preset key and the number pad.

---

- Operation
1. Press  +  - .
  2. Press  to confirm the recall when a popup window appears.
  3. Press  again to deactivate the preset key.



## Default Settings

### Factory Default Settings

---

Description The factory default settings can be recalled at any time. See page 217 for a list of the factory default settings.

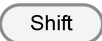
---



- Operation
1. Press  + .
  2. Select Default with the *Media[F1]* soft-key.
  3. Press *Factory Default[F2]*.
  4. Press *Factory Default[F2]* again to confirm.



## User's Default Setting

---

Description                      The currently active settings can be set as the "User's Default" settings.

---

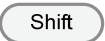
- Save User's Default Setting
1. Press  + .
  2. Select *Default* with the *Media[F1]* soft-key.
  3. Press *Save[F3]*.
- The User's Default is saved immediately.
- 

- Recall User's Default Setting
1. Press  + .
  2. Select *Default* with the *Media[F1]* soft-key.
  3. Press *Recall[F4]*.
  4. Press *Recall[F4]* again to confirm.
- A User's Default must be saved first before it can be recalled.



# F FUNCTION MENU

---

Function Menu Overview .....	128
Select a Function .....	128
Turning on the Load with the Selected Function .....	130
Complete Ring Time .....	131
NSEQ Timer .....	132
Program .....	134
Program Overview .....	134
Create a Program .....	136
Create a Program Chain .....	139
Running a Program or Chain .....	140
Sequence .....	142
Normal Sequence Overview .....	142
Timing Edit Configuration .....	147
Data Edit Configuration .....	149
Running a Normal Sequence .....	151
Fast Sequence Overview .....	153
Timing Edit Configuration .....	157
Data Edit Configuration .....	158
Running a Fast Sequence .....	160
OCP Test Automation .....	162
OPP Test Automation .....	168
BATT Test Automation .....	174

## Function Menu Overview

The Function menu can be used as a quick access hub to the Program, Normal Sequence, Fast Sequence or OCP menus.

It is also used to set Function specific settings:

- Function Select.
- Complete Ring Time.
- NSEQ Timer.

### Select a Function

Description	The Function Select option is used to turn a Program, Normal Sequence, Fast Sequence or OCP function on or off. Before one of these functions are turned on, they should be configured beforehand. See page 134, 142, 162 to configure Programs, Sequences or the OCP function, respectively.
-------------	---

Function Select Screen



## Operation

1. Press .
2. Select *Function Select* and choose a function to turn on or choose to turn off the last function.  
Range OFF, PROG, NSEQ, FSEQ, OCP



## Note





- After a function is selected, it is then “turned on”.
- **PROG**, **NSEQ**, **FSEQ** or **OCP** will appear at the top of the display when the selected function is on.
- When in the Main menu, the PROG, NSEQ, FSEQ or OCP icon will appear prominently on the display to remind the operator that a function is still on. A normal load cannot be turned on when a Function mode is turned on.



- Be sure to turn the selected function off to return to normal operation.

## Turning on the Load with the Selected Function

---

- Description
1. When a function is turned on, the load can be turned on (with the selected function) by pressing  + . This can be done at anytime.
    - The  key will turn orange when the load is “on”.
    - The load can be turned off again by pressing the  key.
    - The **PROG**, **NSEQ**, **FSEQ** or **OCF** icon turns orange when the load is turned on.
    - The selected function will need to be turned off before a “normal” load operation can be performed.
- 

Display

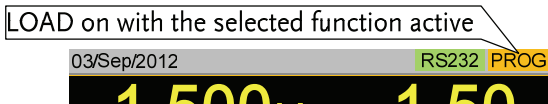

## Complete Ring Time

---

**Description** The Complete Ring Time function turns the alarm on for a user-set amount of time after a program, sequence or OCP function has finished.

---

**Function Select Screen**

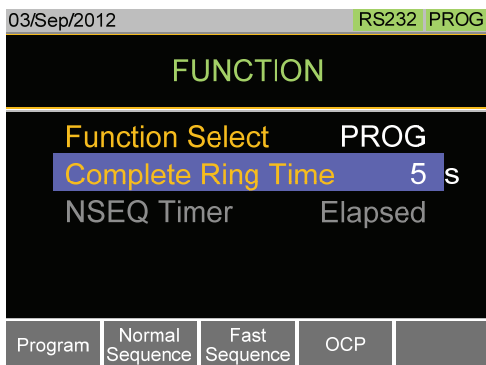

**Operation**

1. Press .
  2. Select *Complete Ring Time* and select how long the alarm should ring after a function has completed.
    - Range OFF, 1 ~ 600s, Infinity
    - Default Off
- The Complete Ring Time setting applies to all the functions.
- 



**Note**

The alarm may not sound if Alarm Tone is turned off in the Utility>Other menu.

## NSEQ Timer

**Description** The NSEQ Timer setting determines whether the timer for the Normal Sequence function displays the elapsed time or the remaining time for both the current step and the overall test time for the sequence.

**Function Select Screen**



**Operation**

1. Press  .
2. Select *NSEQ Timer* and select whether the current step and total test time is displayed as elapsed time or remaining time.
 

Range	Elapsed, Remaining
Default	Elapsed

Display example

The screenshot shows a test instrument display with the following information:

- Top left: 03/Sep/2012
- Top right: RS232 NSEQ
- Center: 0.000V, 0.000A, 0:00:05
- Bottom left: Continue button
- Bottom right: Run N.Seq. 0:00:05, Seq. No: 01, Step 0003, Loop: 0001

Callout 1 (top right): Elapsed or remaining time for the total test time

Callout 2 (bottom right): Elapsed or remaining time for the current step

 Note

When the total test time is >1000 hours, then the total test time will always be displayed as the elapsed time.

## Program

The PEL-3000 can create programs that are designed to step-through up to 16 pre-set load operations. The program function is a powerful tool that can allow you to perform a number of different operations in succession.

- The execution time of each step is user-defined.
- Programs can be chained together to make larger programs.
- Up to 16 programs can be created for a program chain.

See page 112 for saving load operations.

### Program Overview

---

#### Description

When you run a program, you are essentially executing up to 16 different load operations consecutively. Each of the different load operations are “steps” in the program. A program starts at step 01 and ends at step 16.

- A program recalls the operating mode, range, static/dynamic mode, response speed and other settings of each step from stored memory. It also recalls the Go-NoGo settings.
  - The same memory settings can be used for multiple steps.
  - The execution time of each step is configurable.
  - Applies the Go-NoGo settings for each step.
  - Each step must be executed in order.
  - Each step can be configured to automatically go to the next step or wait for confirmation from the user before proceeding to the next step.
  - Individual steps can be skipped.
  - Programs can be linked together to make
-



program chains.

- Program chains need not be executed in order.
- There are 16 steps to a program.
- There are up to 16 programs to a chain.

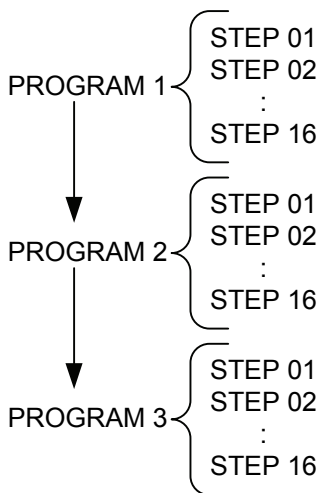

---

#### Setting Overview

A program contains the following settings for each step:

- Memory: the memory location of the load operation for the selected step (M001-M256).
  - Run: Designates the run setting for the step (Auto, Manual, Skip).
  - On-Time: Sets the run time of the test.
  - Off-Time: Sets the off time between steps.
  - P/F-Time: Sets the testing pass/fail delay time for GoNo Go testing.
  - Short-Time: Sets the shorting time for the step, if any.
-

Timing Diagram for Single Step      Below is a timing diagram of a single step in a program.

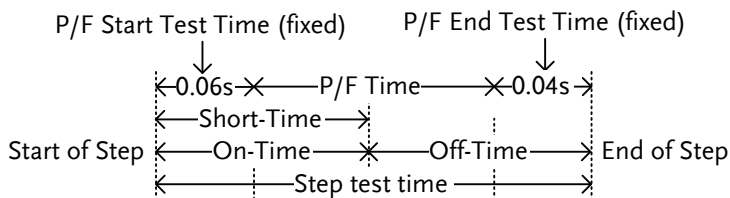

## Create a Program



Note

Before creating a program, the settings for each step must first be created and saved to internal memory (M001-M256). See the save recall chapter for further details, page 112.

Program Setting Display Overview

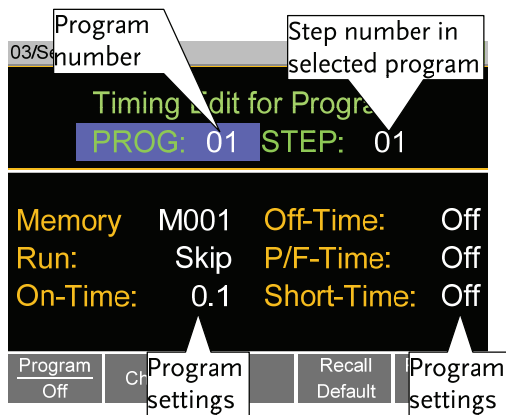

Operation

1. Press **FUNC** > *Program*[F1].
  - Note that *Program*[F1] is off by default.
2. Select *PROG* and select a program number to edit.

PROG 01 - 16

3. Select a *STEP* in the selected program.

STEP 01 - 16

4. Select *Memory* and select which memory location to load for the selected step.

- Settings loaded from the memory location will be used for the selected step.
- The same memory location can be used for multiple steps.

Memory M001 - M256

5. Set the *Run* setting for the step.

- By default RUN is set to Skip.
- The Auto setting will automatically start and go onto the next step.
- The Manual setting will wait for the user to press *Next[F2]* before running the step.

Run Skip, Auto, Manual

6. Choose the *On-Time* in seconds.

- The on-time setting determines how long the load is turned on for the selected step.
- The on-time is defined as the total test time minus the off-time.

On-Time 0.1 - 60 seconds

7. Choose the *Off-Time* in seconds.

- The off-time setting determines how long the load is turned off between the end of the current step and the start of the next step.
- The off-time is defined as the total test time minus the on-time.

Off-Time Off, 0.1 - 60 seconds

8. Choose the *P/F-Time* (pass/fail time) in seconds.
    - The P/F-Time refers to the P/F delay time. This delay time includes the 0.06 P/F start test time, as shown in the timing diagram on page 86.  
P/F-Time Off, 0.0 - 119.9 seconds
  9. Set the *Short-Time* in seconds.
    - Has the same action as pressing the short key.  
Short-Time Off, 0.1 seconds - On-Time
  10. Repeat steps 3 to 9 for all the steps in the program.
    - A maximum of 16 steps per program can be created.
    - Steps that are not configured are set to "Skip" by default.
  11. Press *Save[F3]* to save the program and all the steps in the program.
    - The program will be saved to internal memory.
    - See the Save/Recall chapter on details on how to save to Setup memory.
- 

**Recall Default**

Pressing *Recall Default[F4]* will recall the default settings for each program/step. See page 217 for details.

## Create a Program Chain



Note

Before creating a program chain, make sure a number of programs have already been saved. These will be used to create the program chain.

Chain Setting  
Display Overview



Operation

1. Press **FUNC** > *Program*[F1] > *Chain*[F2].
  - It may be necessary to load the programs from Setup memory if they were not created in the current session.
2. If *Start* is not already selected, press *Select Start*[F1] and select which program will be used to start the program chain.  
Start: P01 - P16
3. Select *P01* and choose which program will be linked to P01.
  - Selecting OFF will end the chain after P01.
  - Selecting P01 will create an infinite chain.
  - Chains need not be linked in sequential order.  
P01: OFF, P01 - P16

4. Repeat step 3 for any remaining programs in the chain.
5. Press *Save* to save the program chain to internal memory.

Pressing *Recall Default*[F4] will reset the chain to the default settings. See page 217 for details.

- Recall Default[F4] will essentially clear the program chain.

## Running a Program or Chain

Description	A program or program chain is run the same way as a normal load.
-------------	--

- |           |   |
|-----------|---|
| Operation | <ol style="list-style-type: none"> <li>1. Press  &gt; <i>Program</i>[F1].</li> <li>2. Turn program mode on by setting <i>Program</i>[F1] to On. <ul style="list-style-type: none"> <li>• <b>PROG</b> will appear at the top of the display when <i>Program</i> is On.</li> </ul> </li> <li>3. Turn the load on. <ul style="list-style-type: none"> <li>• The program/chain starts immediately.</li> <li>• The <b>PROG</b> icon turns orange when the load is turned on.</li> </ul> </li> <li>4. When a program/chain is running the screen displays which program, step and memory is currently active. <ul style="list-style-type: none"> <li>• Press <i>Pause</i>[F1] to suspend a test, press <i>Continue</i>[F1] to resume.</li> <li>• Press <i>Next</i>[F2] to run the next step if its <i>Run</i></li> </ul> </li> </ol> |
|-----------|---|

setting was set to *Manual*.

5. When a program/chain has finished running, a list of the Go-NoGo results for each step are displayed.
  - Press *Exit*[F5] to exit.

Display:  
Program/Chain  
Running

The screenshot shows the 'Run Program' screen with the following data:

03/Sep/2012	RS232 PROG
0.000V	0.00W
0.000A	
Run Program	
Program No:	01
Step(Memory)	01(001) GO

Callouts from the image:

- Program number that is currently running. (points to '01')
- Step that is currently running. (points to '01(001)')
- Memory number of current step. (points to '001')
- No-NoGo result for the step (points to 'GO')

Display:  
Program/Chain  
Finished

The screenshot shows the 'Run Program Detail Result' screen with the following table:

Program	Step	Result
1	1	GO
1	2	GO
1	3	NG

At the bottom right of the screen, there is an 'Exit' button.

## Sequence

The PEL-3000 supports both programs and sequences. The essential difference between programs and sequences is that programs can use different operating modes for each step while sequences use the same operating mode throughout the whole sequence. In effect sequences are used to create complex load simulations.

There are two different types of Sequences, Normal Sequences and Fast Sequences.

Normal sequences can define the execution time and slew rate of each step.

On the other hand the execution time for each step in a fast sequence is fixed to the rate (Time Base setting) set by the user.

### Normal Sequence Overview

---

Description	<p>A normal sequence is comprised of a user-defined number of steps that when executed in sequence can be used to simulate a DC load.</p> <ul style="list-style-type: none"><li>• Up to 1000 discrete steps can be configured using normal sequences.</li><li>• Each normal sequence can have a memo note attached to it.</li><li>• Normal Sequences can be looped up to 9999 discrete times or for an infinite amount of times.</li><li>• Normal sequences can be configured to hold a set voltage, current, power or resistance at the end of the load.</li><li>• Normal Sequences can be linked together in a chain.</li></ul>
-------------	---

---



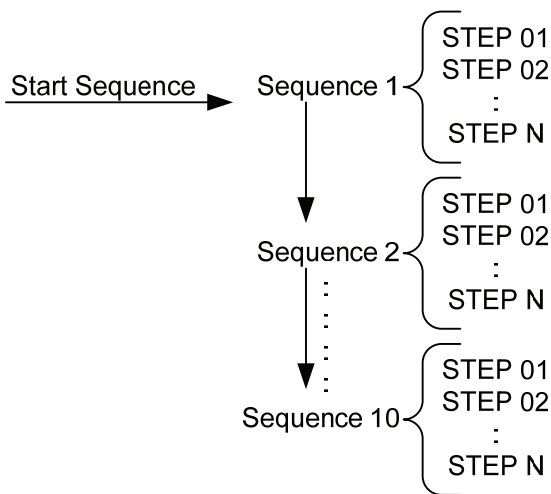

**Description** Normal Sequence configuration is split into Timing Edit configuration and Data Edit configuration.

Timing Edit configuration is used to configure the actual sequences, such as mode, range, loops and chains.

Data Edit configuration is used to create the actual steps used in each sequence.

See below for a description of each.

**Timing Edit Overview** A Normal Sequence contains the following timing settings for each sequence:

Setting	Setting Range	Description
Start	S01 - S10	Sets which sequence is used to start a chain of Normal Sequences.
Seq.No	S01 - S10	Sets the current sequence to edit.

Memo	12 characters	A user-created note for the currently selected sequence.
Mode	CC, CR, CV, CP	Operating mode for the sequence. +CV mode is supported.
Range	ILVL	Low I range, low V range
	IMVL	Middle I range, low V range
	IHVL	High I range, low V range
	ILVH	Low I range, high V range
	IMVH	Middle I range, high V range
	IHVH	High I range, high V range
Loop	Infinite, 01 - 9999	Sets the amount of times to loop the selected sequence.
Last Load	OFF, ON	Set the load condition after the end of the sequence.
Last	Value	The setting value of the load for when Last Load = ON.
Chain	Off, S01-S10	Sets the next sequence in the chain, when not set to off.

Data Edit Overview Each step in a normal sequence contains the following setting parameters:

Setting	Setting Range	Description
Step	0001 - 1000	Selects/displays the current step in the sequence. <ul style="list-style-type: none"> <li>The number of available steps is dependent on the number of steps added using the <i>Insert Point[F1]</i> functions.</li> </ul>
Value		The current, voltage, power or resistance setting for the selected operating mode.
Time	0.05ms - 999h:59m	Sets the step time for the selected step.
Load	ON, OFF	Turns the load on or off for the selected step.

RAMP

ON, OFF

When turned on the current transition is evenly ramped from the start of the step to the end of the step. When turned off the current transition is stepped.

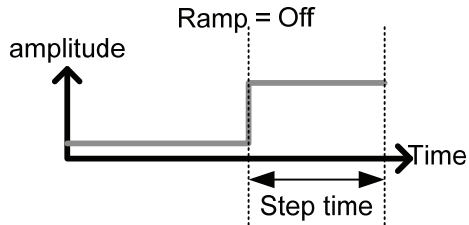
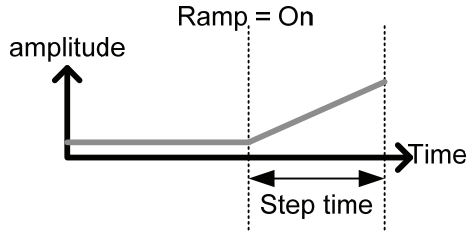

TRIG OUT

ON, OFF

When TRIG OUT is set to ON, a trigger signal is output from the TRIG OUT BNC terminal at the start of the step. See page 199 for details.

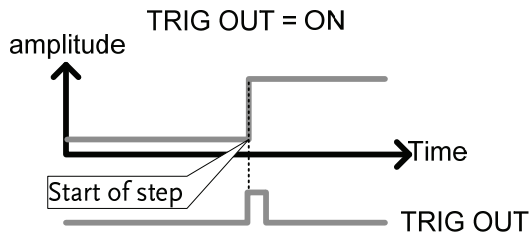

---

PAUSE	ON, OFF	Pause: Inserts a pause at the end of the step. When paused, the unit will pause at the end of the step current/voltage/resistance/power level. The sequence can be resumed by pressing <i>Next[F2]</i> or by using an external trigger signal (page 199).
-------	---------	---

---

## Timing Edit Configuration

Edit Timing  
Display

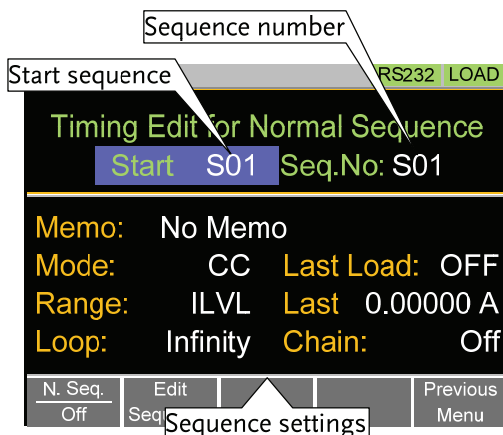

Operation

1. Press **FUNC** > *Normal Sequence*[F2].
  - Note that *N. Seq.*[F1] is off by default.
2. Select *Start* and select the number of the starting sequence.
 

Start: S01 - S10
3. Select a *Seq. No.* and select which sequence to edit.
 

Seq. No.: S01 - S10
4. Set the following parameters for the currently selected sequence. See page 93 for details on each parameter.
  - Memo
  - Mode
  - Range
  - Loop
  - Last Load

- Last
  - Chain
5. Press *Save*[F3] to save the timing settings for the currently selected sequence.

Sequence Timing configuration is complete.

- Go to Data Edit to edit the steps used in the Normal Sequences. See page 99.
- Go to Running a Normal Sequence to run the normal sequence. See page 101.

## Data Edit Configuration

### Data Edit Display

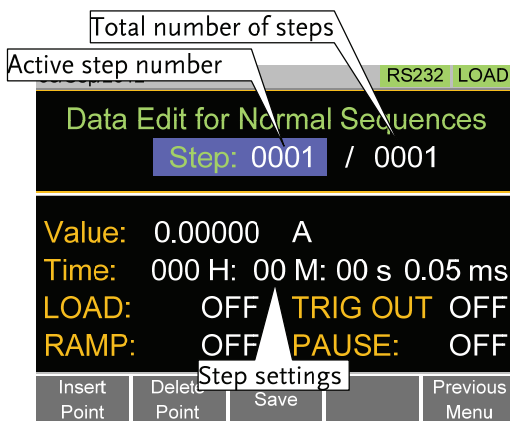

### Operation

1. Press **FUNC** > *Normal Sequence*[F2] > *Edit Sequence*[F2].
2. Select *Seq.No.* and select the sequence you wish to edit.  
Start: S01 - S10
3. Press *Edit Sequence* [F2] to enter the Data Edit configuration menu.
  - Note that when there no steps in the current sequence the Data Edit for Normal Sequence settings are blank.
4. Press *Insert Point*[F1] to add a step to the sequence after the current step.
  - Every time *Insert Point* is pressed the *Step* parameter is incremented.
  - The inserted point becomes the current step.

5. Set the following parameters for the currently selected step. See the Data Edit Overview on page 95 for configuration details.
  - Value
  - Time
  - LOAD
  - RAMP
  - TRIG OUT
  - PAUSE
6. If you wish to edit a previously inserted point/step, use the *Step* parameter.
  - Steps can only be selected after they have already been inserted.  
Steps            0001 - 1000
7. The currently selected step can be deleted using the *Delete Point[F2]* function.
8. After all the steps for the sequence are complete, press *Save[F3]* to save the steps.

Data Edit for Normal Sequence configuration is complete.

- Go to Timing Edit for Normal Sequences to edit the sequence. Page 98.
  - Go to Running a Normal Sequence to run the normal sequence. Page 101.
-





## Running a Normal Sequence



---

**Description** Unlike a normal static or dynamic load, a load created with the Normal Sequence function is turned on by pressing the Shift and Load keys.

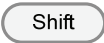
---

- Operation**
- Press  > *Normal Sequence*[F2].
  - Turn normal sequence mode on by setting *N. Seq.*[F1] to *On*.
    - NSEQ** will appear at the top of the display when *N. Seq.* is *On*.
    - The Normal Sequence function can also be turned on from the FUNC menu. See page 128 for details.
  - Turn the load on by pressing
 

 + 

    - The  key will turn orange when the load is “on”.
    - The load can be turned off again by pressing the  key.
    - The normal sequence/chain starts immediately.
    - The **NSEQ** icon turns orange when the load is turned on.
  - When a normal sequence/chain is running, the screen displays which sequence, step and loop are currently active. It also displays the elapsed or remaining test time and elapsed/remaining time of the current step.
    - Sequences can be paused by pressing *Pause*[F1]
-

and resumed again by pressing Continue[F1].

- If no steps have been created “No N.Seq.” will be displayed on the screen.
- “Sequence Complete” will be displayed at the end of the sequence.

Display:  
Sequence/Chain  
Running

The screenshot shows the following display content:

- Top status bar: 03/Sep/2012 (left), RS232 NSEQ (right)
- Readback measurements: 0.000V, 0.000A, 0.000V, 0:00:46
- Sequence info: Run N.Seq. 0:00:05, Seq. No: 01, Step 0003, Loop: 0001

Callouts point to the following elements:

- Current step readback measurements (points to the 0.000V and 0.000A values)
- Elapsed or remaining time for the total test time (points to the 0:00:46 value)
- Current sequence, step and loop number (points to the Seq. No, Step, and Loop values)
- Step elapsed/remaining time (points to the 0:00:05 value)

 Note

The combined test time for all sequences will be displayed as *elapsed test time* if the elapsed time is >1000 hours, else the *remaining test time* will be displayed.

## Fast Sequence Overview

---

- Description
- A fast sequence is comprised of a user-defined number of steps that can be executed at a high frequency. Unlike normal sequences, each step in a fast sequence has the same execution time (time base).
- This mode is only available for CC and CR mode.
  - Up to 1000 discrete steps can be configured using fast sequences.
  - Each fast sequence can have a memo note attached to it.
  - Fast Sequences can be looped up to 9999 discrete times or for an infinite amount of times.
  - Fast sequences can be configured to hold a set current or resistance at the end of the load.
  - No ramping function can be used with the Fast Sequence function.

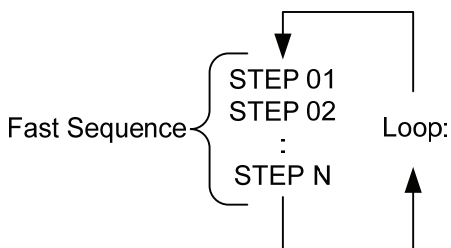

Description Fast Sequence configuration is split into Timing Edit configuration and Data Edit configuration.

Timing Edit configuration is used to configure all the settings that are common to all the steps of the fast sequence. This includes settings such as the mode, range, loops and time base.

Data Edit configuration is used to create the actual steps used in each sequence.

See below for a description of each.

Timing Edit Overview A Fast Sequence contains the following timing settings for each sequence:

Setting	Setting Range	Description
Memo	12 characters	A user-created note for the currently selected sequence.
Mode	CC, CR	Operating mode for the sequence.
Range	ILVL	Low I range, low V range
	IMVL	Middle I range, low V range
	IHVL	High I range, low V range
	ILVH	Low I range, high V range
	IMVH	Middle I range, high V range
	IHVH	High I range, high V range
Loop	Infinity, 01 - 9999	Sets the amount of times to loop the selected sequence.
Last Load	OFF, ON	Set the load condition after the end of the sequence.
Last	0.000000	The load setting for when Last Load is set to ON.
RPTSTEP	0001 - 1000	Last step number (0001-1000) per loop
Time Base	0.025 - 600ms	Sets the step execution time.

Data Edit Overview Each step in a fast sequence contains the following setting parameters:

Setting	Setting Range	Description
Step	0001 - 1000	<p>Selects/displays the current step in the sequence.</p> <ul style="list-style-type: none"> <li>The number of available steps is dependent on the number of steps added using the <i>Ins. Point[F1]</i> functions.</li> <li>A minimum of 3 steps.</li> </ul>
Value		The current or resistance setting for the selected operating mode.
TRIG OUT	ON, OFF	<p>When TRIG OUT is set to ON, a trigger signal is output from the TRIG OUT BNC terminal at the start of the step. See page 199 for details.</p>

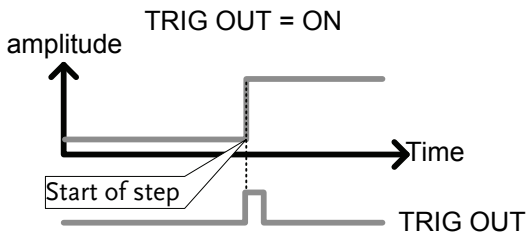

FILL Overview The FILL function is used to evenly step up the current or resistance value settings from a starting step to a finishing step.

The Fill Function can be used before or after points are added to the fast sequence.

- Before: Will pre-fill each value within the fill range when a new step is added.
- After: Will post-fill each value within the fill

range.

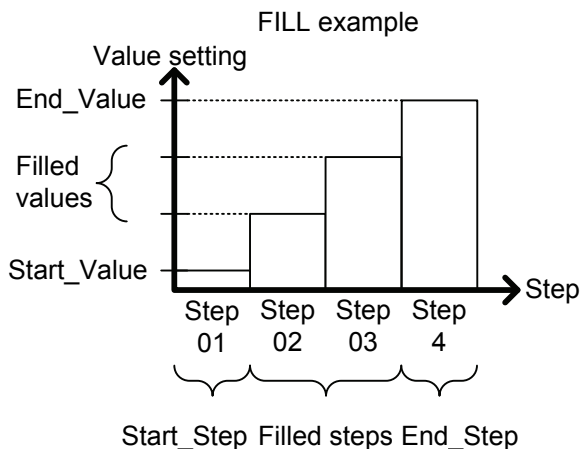

Setting	Setting Range	Description
Start_Value		Sets the current or resistance value for the starting step.
End_Value		Sets the current or resistance value for the ending step.
Start_Step	0001 - 1000	Sets the starting step number.
End_Step	0001 - 1000	Sets the ending step number.

## Timing Edit Configuration

Edit Timing  
Display

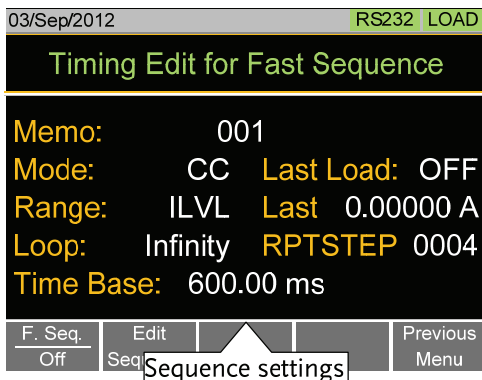

Operation

1. Press **FUNC** > *Fast Sequence*[F3].
  - Note that *F. Seq.*[F1] is off by default.
2. Set the following parameters for the fast sequence. See page 152 for details on each parameter.
  - Memo
  - Mode
  - Range
  - Loop
  - Time Base
  - Last Load
  - Last
  - RPTSTEP

Save

Press *Save*[F3] to save the timing settings for the fast sequence.

Sequence Timing configuration is complete.

- Go to Data Edit to edit the steps used in the Fast Sequence. Page 108.
- Go to Running a Fast Sequence to run the fast sequence. Page 110.

## Data Edit Configuration

### Data Edit Display

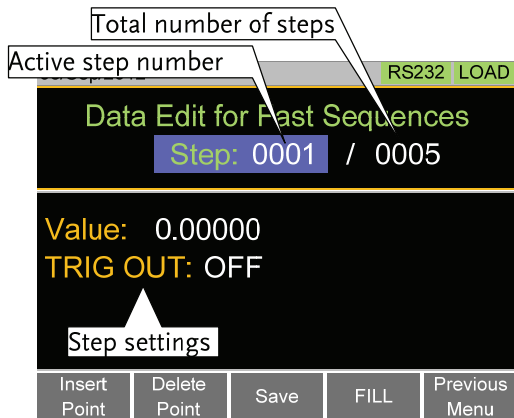

### FILL Display

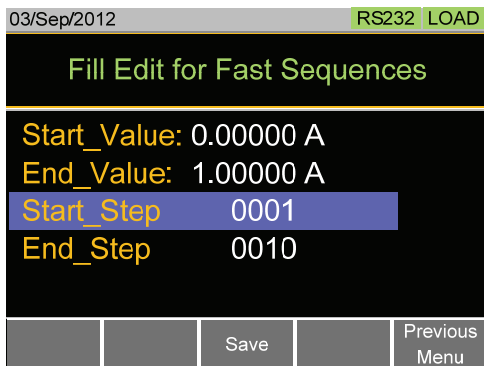

### Operation

1. Press **FUNC** > *Fast Sequence*[F3] > *Edit Sequence*[F2] to enter the Data Edit configuration menu.
2. Press *Insert Point*[F1] to add a step to the



sequence.

- Every-time *Insert Point* is pressed the *Step* parameter is incremented.
  - The newly inserted “point” becomes the active step.
3. Set the following parameters for the currently selected step. See page 152 for configuration details.
    - Value
    - TRIG OUT
  4. If you wish to edit a previously added point/step, use the *Steps* parameter.
    - Steps can only be selected after they have already been added.  
Steps        0001 - 1000(RPTSTEP)
  5. The currently selected step can be deleted using the *Delete Point[F2]* function.
    - There cannot be less than 3 steps for fast sequences.
- 

#### Fill Function

Press *FILL[F4]* to use the fill function. Set the fill parameters:

- Start\_Value
- End\_Value
- Start\_Step
- End\_Step

The fill function can be used any number of times.

---

#### Save

After all the steps for the sequence are complete, press *Save[F3]* to save the steps.

---



Data Edit for Fast Sequences configuration is complete.



- Go to Timing Edit for Fast Sequences to edit the sequence. Page 107.
- Go to Running a Fast Sequence to run the fast sequence. Page 110.

## Running a Fast Sequence

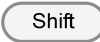
**Description** Unlike a normal static or dynamic load, a Fast Sequence load is turned on by pressing the Shift and Load keys.

- Operation**
1. Press  > *Fast Sequence*[F3].
  2. Turn fast sequence mode on by setting *F. Seq.*[F1] to On.
    - **FSEQ** will appear at the top of the display when *F. Seq.* is On.
    - The Fast Sequence function can also be turned on from the FUNC menu. See page 128 for details.
  3. Turn the load on by pressing
 

 + .

    - The  key will turn orange when the load is "on".
    - The load can be turned off again by pressing the  key.
    - The fast sequence/chain starts immediately.
    - The **FSEQ** icon turns orange when the load is turned on.

4. When a fast sequence is running, the screen displays which step and loop is currently active.
- “Sequence Complete” will be shown on the display at the end of the sequence.

Display:  
Fast Sequence  
Running



## OCP Test Automation

**Background** The OCP test function creates an automatic test to test the OCP of power supply products.

This test will test to see when the over current protection of a power supply is tripped and return the measurements for the voltage and current when the over current protection was tripped. The PEL-3000E also has a user-defined cutoff setting in the event that the power supply OCP fails.

The diagram below shows an example of the OCP Test Automation function:

**Example** The test current increases from a starting value (Start C) to an end value (End C). The current increases in steps (set by Step\_C) with a set step time (set by Step\_T) until the power supply's OCP is tripped or the End C current level is reached.

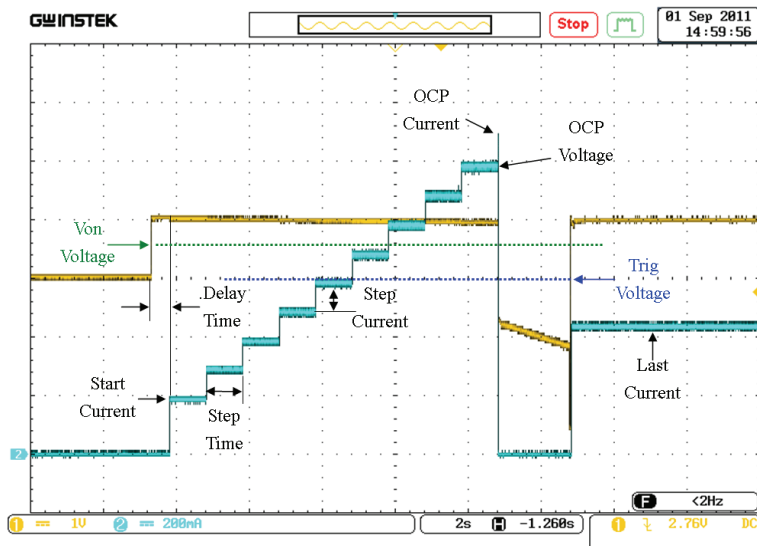

---

Parameters	OCP. No	Selects one of 12 OCP test setup memories.
	Range	High(CC Mode High), Mid(CC Mode Middle) and Low(CC Mode Low)
	Start Current(Start C)	Starting current value for the test.
	End Current(End C)	The current value that will end the test. The value must be higher than the OCP value of the DUT you are testing. This parameter is used as a fail-safe for if the over current protection of the DUT fails. If the measured current is reaches End Current value it would then indicate that the power supply OCP failed.
	Step Current(Step_C)	Sets the step resolution of the current.
	Last Current>Last_C)	Sets the final current value after OCP has been tripped. This is the steady-state current draw after the OCP has been tripped.
	Step Time(Step_T)	Sets the execution time of each step. (50ms to 1600s)
	Delay Time(Delay)	The OCP testing delay time. Sets the how long to delay starting the test after the Load On key has been pressed. (5ms ~ 160ms)

**Trig Voltage(Trig\_V)** Sets the trigger to a level needed to see when the power supply OCP has been triggered. When the power supply OCP has been triggered, its voltage output will reset. The voltage trigger level is used to test to see if the voltage output has been reset.



Note

This mode can only be used under CC mode.

Panel operation

1. Press **FUNC** > *OCP[F4]*.



2. Select *OCP. No:* and select a test setup memory.  
*OCP. No:* 1 ~ 12
3. Set the following parameters for the selected test setup above:
  - Range
  - Start C
  - End C
  - Step\_C

- Last\_C
- Step\_T
- Delay
- Trig\_V

4. Press the *Save*[F3] to save the selected test setup.

Start OCP

5. Press *OCP*[F1] to turn the OCP function on if it is off.

6. The OCP function can be started by turning the load on by pressing **Shift** + **Load<sup>On/Off</sup>**.

- The test current will increase from the Start C value to the End C value in steps according to the Step C value, until the test has finished.
- The test will start running when the power supply voltage is greater than the Trig V voltage.

Example: OCP  
Function running

The screenshot shows the OCP Test Running screen with the following data:

Set Curr.	Fetch Volt
2,000	0.91
1,500	0.91
1,000	0.92

Callouts from the image:

- Measured voltage, current and power: 0.91V, 1.960A, 1.78W
- Set current for the last three steps (descending order): 2,000, 1,500, 1,000
- Measured voltage for the last three steps (descending order): 0.91, 0.91, 0.92

Results:

Power Source  
OCP tripped

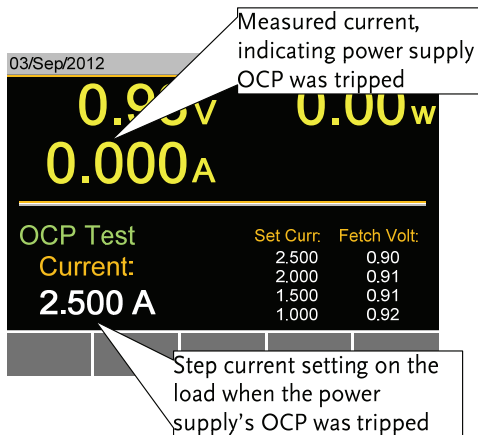

The OCP Test will return the current setting of the last step when the power supply's OCP was tripped.

Power Source  
OCP time out

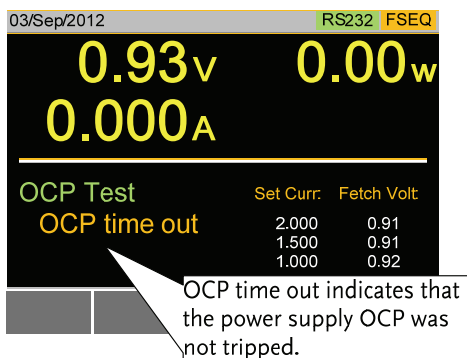

OCP time out will occur if the power supply's OCP fails to trigger. This is determined when the measured voltage is less than Trig V and the measured current is greater than End C.



Power Source  
Config Error

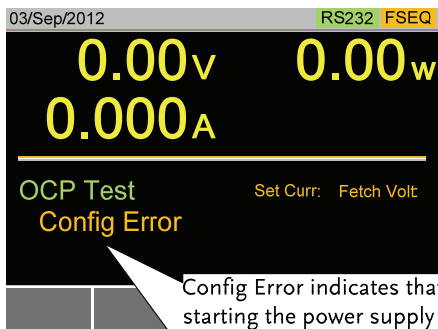

Config Error indicates that upon starting the power supply voltage is less than the Trig V voltage.

Config Error indicates that the power supply voltage is less than the Trig V voltage setting after the test has started. This can indicate that the power supply output is not on or that the power supply output or Trig V is incorrectly configured.



In addition to the OCP settings as described above, the VON voltage settings must also be set according to the output characteristics of the DUT.

## OPP Test Automation

**Background**      The OPP test function creates an automatic test to test the OPP of power supply products.

This test will test to see when the over power protection of a power supply is tripped and return the measurements for the voltage and current when the over power protection was tripped. The PEL-3000E also has a user-defined cutoff setting in the event that the power supply OPP fails.

The diagram below shows an example of the OPP Test Automation function:

**Example**      The test watt increases from a starting value (Start W) to an end value (End W). The watt increases in steps (set by Step\_W) with a set step time (set by Step\_T) until the power supply's OPP is tripped or the End W watt level is reached.

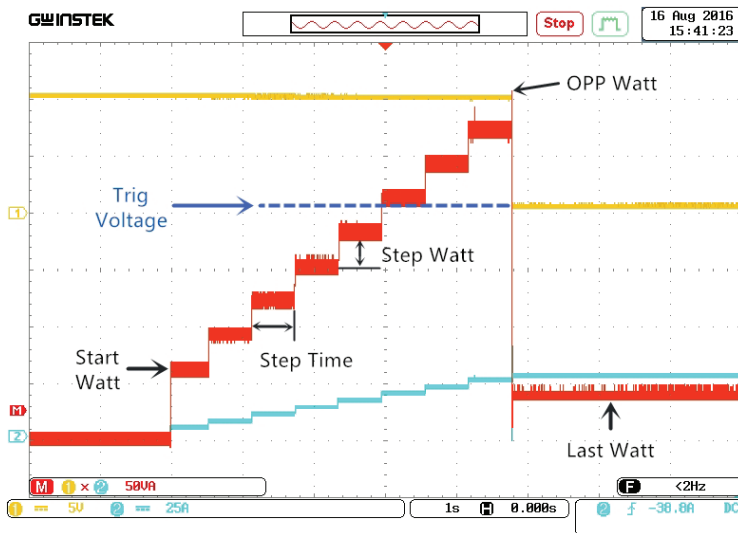

---

Parameters	OPP. No	Selects one of 12 OPP test setup memories.
	Range	High(CP Mode High) Low(CP Mode Low)
	Start Watt (Start W)	Starting watt value for the test.
	End Watt(End W)	The watt value that will end the test. The value must be higher than the OPP value of the DUT you are testing. This parameter is used as a fail-safe for if the over power protection of the DUT fails. If the measured watt is reaches End Watt value it would then indicate that the power supply OPP failed.
	Step Watt(Step W)	Sets the step resolution of the watt.
	Last Watt(Last W)	Sets the final watt value after OPP has been tripped. This is the steady-state watt draw after the OPP has been tripped.
	Step Time(Step T)	Sets the execution time of each step. (10ms to 50s)
	Trig Delay Time(Delay)	Sets a delay corresponding to the time a Trig Voltage can be expected after each step Watt is applied (the delay time must be less than the Step time).

**Trig Voltage(Trig V)** Sets the trigger to a level needed to see when the power supply OPP has been triggered. When the power supply OPP has been triggered, its voltage output will reset. The voltage trigger level is used to test to see if the voltage output has been reset.

Panel operation

1. Press **FUNC** > *Next Manu*[F5]. > *OPP*[F1].

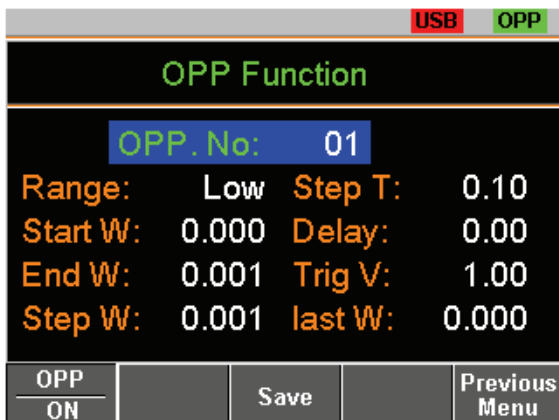

2. Select *OPP.No:* and select a test setup memory.  
*OPP.No:*            1 ~ 12
3. Set the following parameters for the selected test setup above:
  - Range
  - Start W
  - End W
  - Step W

- Last W
- Step T
- Delay
- Trig V

4. Press the *Save*[F3] to save the selected test setup.

Start OPP

5. Press *OPP*[F1] to turn the OPP function on if it is off.

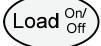
6. The OPP function can be started by turning the load on by pressing  + .

- The test current will increase from the Start W value to the End W value in steps according to the Step W value, until the test has finished.
- The test will start running when the power supply voltage is greater than the Trig V voltage.

Example: OPP  
Function running

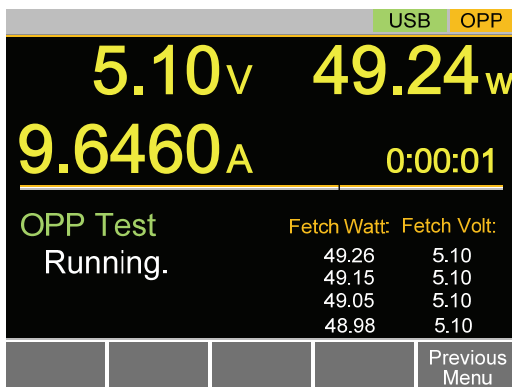

Results:

Power Source  
OPP tripped

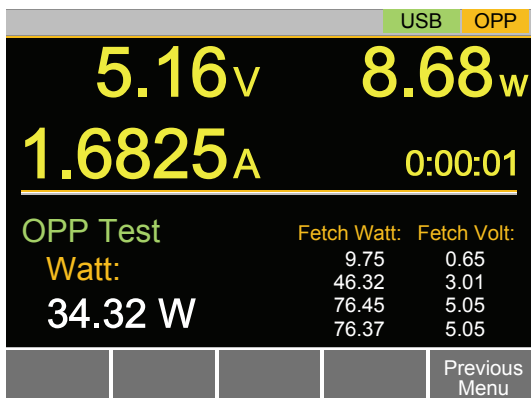

The OPP Test will return the current setting of the last step when the power supply's OPP was tripped.

Power Source  
OPP time out

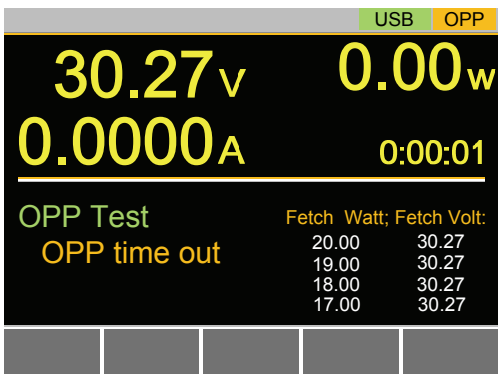

OPP time out will occur if the power supply's OPP fails to trigger. This is determined when the measured voltage is less than Trig V and the measured current is greater than End W.

Power Source  
Config Error

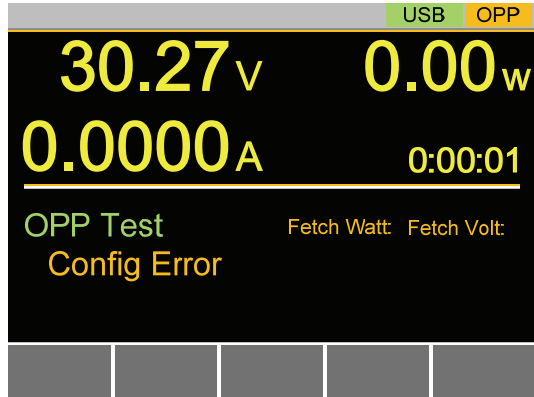

Config Error indicates that the power supply voltage is less than the Trig V voltage setting after the test has started. This can indicate that the power supply output is not on or that the power supply output or Trig V is incorrectly configured.



In addition to the OPP settings as described above, the VON voltage settings must also be set according to the output characteristics of the DUT.

## BATT Test Automation

**Background** The BATT test function creates an automatic test to test the discharge of Battery products.

The test will discharge in a fixed mode (CC, CR, CP) and will end after a defined stop point (stop voltage, stop time, stop AH) has been detected. The information about discharge test (discharge time, battery AH, battery WH) can be finally seen on the panel.

The PEL-3000E also has a user-defined cutoff setting in the event that the Battery test fails.

The diagram below shows an example of the BATT Test Automation function:

**Example** The test will run in the specified mode with defined values and will stop when the defined stop values are reached.

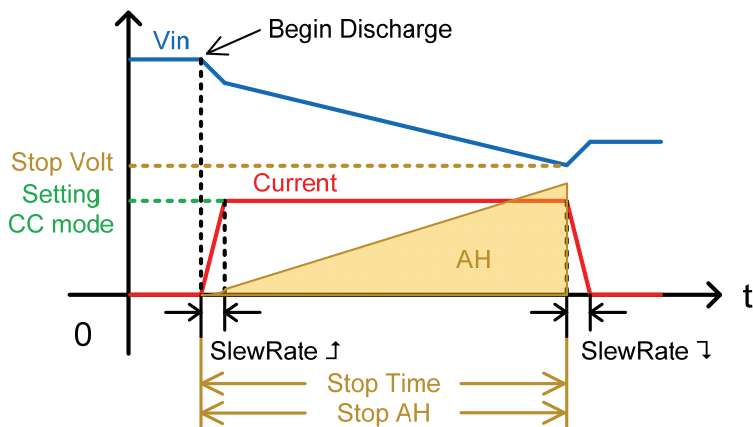



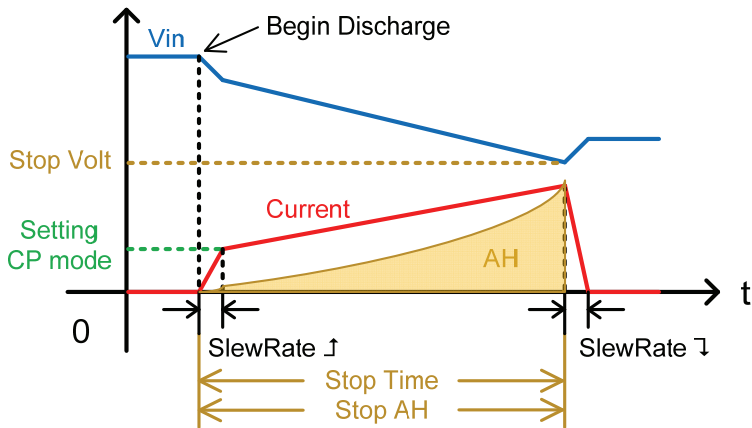
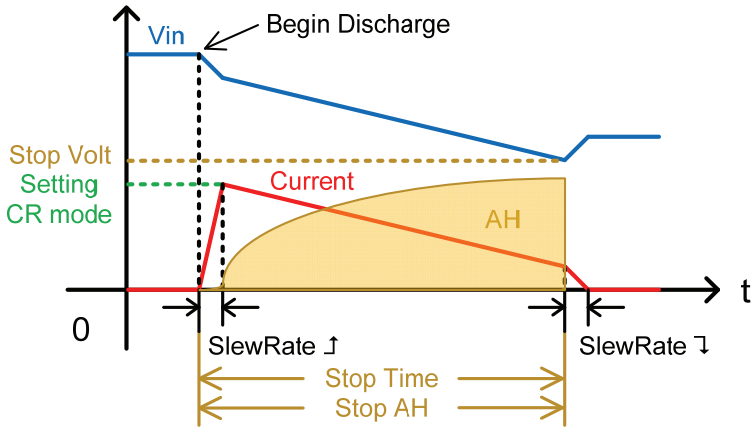

Parameters	BATT No.	Selects one of 12 BATT test setup memories.
	Memo	A user-created note for the currently selected OPP function.
	Mode	Select a discharge operation mode. (CC, CR, CP)

Range	ILVL(I range low, V range low) IHVL(I range high, V range low) ILVH(I range low, V range high) IHVH(I range high, V range high)
Setting	Sets the values corresponding to the defined discharging mode (CC mode in A, CR mode in mS and CR mode in W).
SlewRate↑	Sets the test rising slew rate in mA/us (not adjustable for CP mode).
SlewRate↓	Sets the test falling slew rate in mA/us (not adjustable for CP mode).
Stop Volt	Sets the voltage at which the test should be interrupted. The value must be lower than the battery start voltage.
Stop Time	Sets the time after which the test should be interrupted (max value is 999h:59m:59s).
Stop AH	Sets the discharged energy rate at which the test should be interrupted (Max value is 9999.99Ah).
Datalog timer	Sets the time interval for data capture.

Panel operation

1. Press  > *Next Manu*[F5]. > *BATT*[F2].

USB BATT

### Data Edit for Battery Discharge

BATT No.: 01

Memo: No Memo

Mode: CC

Range: IHVH

Setting: 1.000 A

BATT ON			Previous Menu
------------	--	--	------------------

USB BATT

### Data Edit for Battery Discharge

SlewRate  $\uparrow$  625.0 mA/us

SlewRate  $\downarrow$  625.0 mA/us

Stop Volt: 1.00 V

Stop Time: 000h: 10m: 02s

Stop AH: 1.24 Ah

BATT ON			Previous Menu
------------	--	--	------------------

USB BATT

### Data Edit for Battery Discharge

SlewRate  $\downarrow$  625.0 mA/us

Stop Volt: 1.00 V

Stop Time: 000h: 10m: 02s

Stop AH: 1.24 Ah

Datalog timer 1s

BATT ON			Previous Menu
------------	--	--	------------------

2. Set the following parameters for the selected test setup above:
    - BATT No.
    - Memo
    - Mode
    - Range
    - Setting
    - SlewRate↑
    - SlewRate↓
    - Stop Volt
    - Stop Time
    - Stop AH
    - Datalog timer
  3. Press the *Save[F3]* to save the selected test setup.
- 

Start BATT

4. Press *BATT[F1]* to turn the BATT function on if it is off.
5. The BATT function can be started by turning the load on by pressing

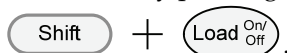

The discharge test will keep running with its defined mode and values until any of the Stop Voltage, Stop Time or Stop AH settings is detected.

Example: BATT  
Function running



Results:

Battery stop  
Voltage or stop  
time or stop AH  
tripped

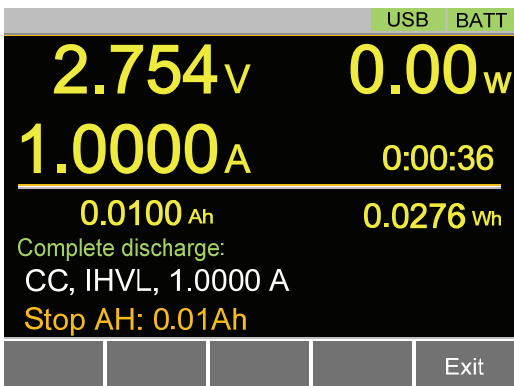
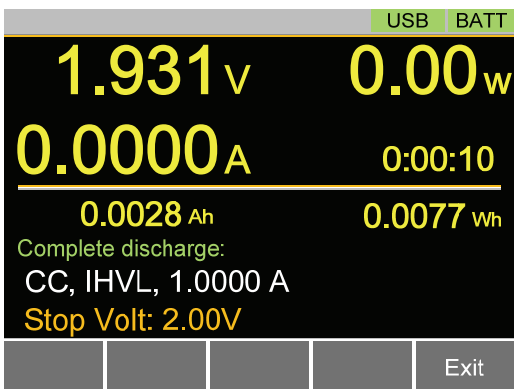

The BATT Test will return the information of the last discharge when the Battery stop voltage or stop time or stop AH was tripped.

---



In addition to the BATT Function settings as described above, the VON voltage settings must also be set according to the output characteristics of the DUT.

---

# E EXTERNAL CONTROL

---

Analog Control.....	183
J1 Connector Overview.....	183
External Voltage Control - Overview .....	184
External Voltage Control – Operation .....	185
External Resistance Control - Overview.....	187
External Resistance Control – Operation .....	189
Turning the Load On using External Control .....	192
Load On/Off Status.....	194
External Control of the Range .....	194
I Range Status .....	195
External Control of the Alarm .....	196
Alarm Status.....	197
Short Control.....	197
Current Monitor Output.....	198
Trigger In/Out BNC .....	199
Trigger Output .....	199
Trigger Input.....	199



## Analog Control

The Analog Control subsection describes how to use the J1 Frame Control Connector for voltage or resistance control. See page 220 for the details on the J1 connector.

### J1 Connector Overview

---

**Description**                      The J1 External Control Connector is a standard Mil 20 pin connector (OMRON XG4A IDC plug). The connector is used for all analog control. The pins are used to determine what mode is used.

See the appendix on page 220 to view the contact pin assignment of the J1 connector.

---

 **WARNING**

Some pins on the frame control connector have the same potential as the front and rear terminals.

To prevent electric shock, ensure that the cover for both the J1 External Control connector is used when the connector is not in use.

### Pin Assignment

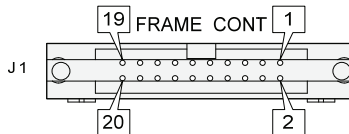

## External Voltage Control - Overview

---

**Background** External voltage control of the CC, CR, CV and CP mode is accomplished using the J1 connector on the rear panel. An input voltage of 0-10V corresponds to 0% - 100% of the rated current (CC mode), rated voltage (CV mode), or rated power (CP mode). For CR mode, 0V - 10V corresponds to the maximum resistance - minimum resistance.

---

**Connection** When connecting the external voltage source to the J1 connector, use a ferrite core and use twisted pair wiring.

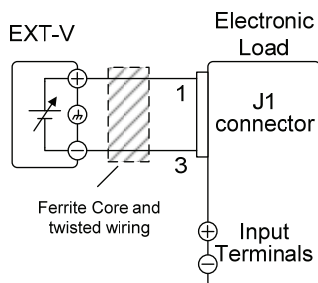

- Pin1 → EXT-V (+)
  - Pin3 → EXT-V (-)
- 



The input impedance for external voltage control is 10k $\Omega$ .

Use a stable voltage supply for the external voltage control.

---



Caution

When using external voltage control, make sure no more than  $\pm 11\text{V}$  is applied across pins 1 and 3. Exceeding this voltage could damage the PEL-3000E. Exceeding  $11.8\text{V}$  will cause an EXT.OV alarm message to appear which also will reset the voltage output to  $0\text{V}$  until the external voltage is reduced back down below  $11.8\text{V}$ .

Use caution when using pin 3. Pin 3 is directly coupled to the negative input terminal.

### External Voltage Control – Operation

**Description** External voltage control can be used to control the current, voltage, resistance and power for CC, CR, CV and CP modes. Configuration for each operating mode is the same.

**CC Mode** Input current = rated current  $\times$  (external voltage/ $10\text{V}$ )

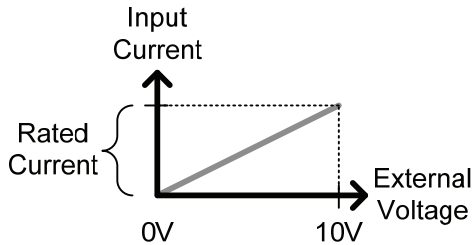

CR Mode                      Input conductance =  
 rated conductance × (external voltage/10V)

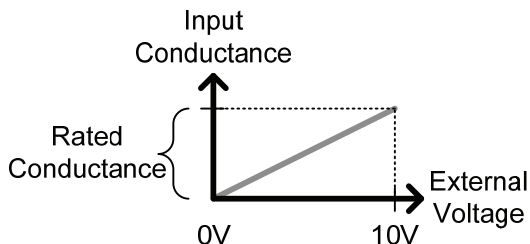

CV Mode                      Input voltage = rated voltage × (external  
 voltage/10V)

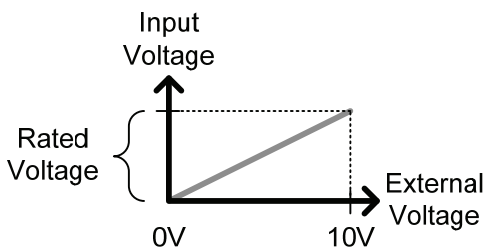

CP Mode                      Input power = rated power × (external  
 voltage/10V)

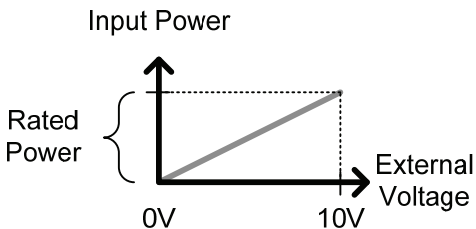

- Operation
1. Turn the power off from the PEL-3000E and from the load.
  2. Connect the external voltage across pins 1 and 3 of the J1 connector.

3. Turn the power on the PEL-3000E.
4. Set the operating mode and range.
  - See page 39 for CC mode.
  - See page 41 for CR mode.
  - See page 43 for CV mode.
  - See page 45 for CP mode.
5. Press  > *Configure [F5]* > *Next Menu [F4]* > *External [F3]*.
6. Set the *Control* parameter to V.
  - The J1 connector is now ready for external voltage control.

## External Resistance Control - Overview

---

### Background

External resistance control of the CC, CR, CV and CP modes is accomplished using the J1 connector on the rear panel.

A resistance of 0k $\Omega$ -10k $\Omega$  is used to control the input current, voltage, resistance or power on the PEL-3000E.

The input can be configured to vary in proportion to the external resistance or the inverse. See page 189 for more details on proportional and inverse resistance control.



Exceeding 11.8k $\Omega$  will cause an EXT.OV alarm message which will reset the voltage output to 0 until the external resistance is reduced back down below 11.8k $\Omega$ .

---

Connection

When connecting the external resistance source to the J1 connector, use a ferrite core and use twisted pair wiring.

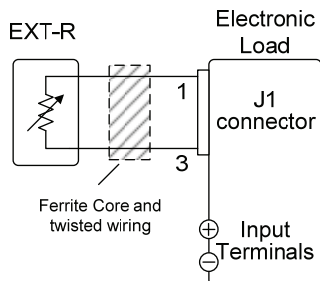

- Pin1 → EXT-R
- Pin3 → EXT-R



Use resistors with minimum residual resistance of 50Ω or less.

Note for proportional control: Do not use switches that switch between fixed resistances. Please use continuously variable resistors.

External Resistance Control – Operation

---

Description External resistance control can be used to control the current, voltage, resistance and power for CC, CR, CV and CP modes. Configuration for each operating mode is the same.

---

CC Mode Proportional Control:  
 Input current = rated current × (external resistance/10kΩ).

Inverse Control:  
 Input current = rated current × (1 - external resistance/10kΩ).

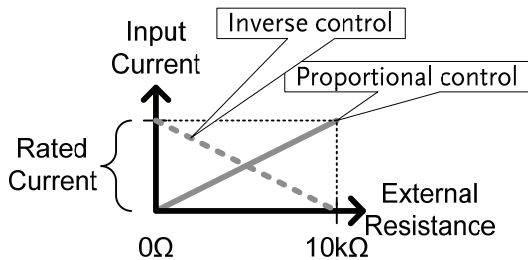

CR Mode

Proportional Control:  
 Input conductance =  
 rated conductance  $\times$  (external  
 resistance/10k $\Omega$ ).

Inverse Control:  
 Input conductance =  
 rated conductance  $\times$  (1 - external  
 resistance/10k $\Omega$ ).

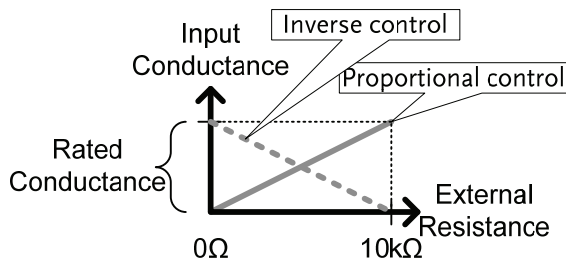

CV Mode

Proportional Control:  
 Input voltage = rated voltage  $\times$  (external  
 resistance/10k $\Omega$ ).

Inverse Control:  
 Input voltage = rated voltage  $\times$  (1 - external  
 resistance/10k $\Omega$ ).

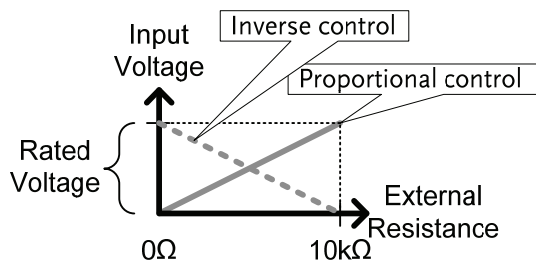



## CP Mode

Proportional Control:

Input power = rated power  $\times$  (external resistance/10k $\Omega$ ).

Inverse Control:

Input power = rated power  $\times$  (1 - external resistance/10k $\Omega$ ).

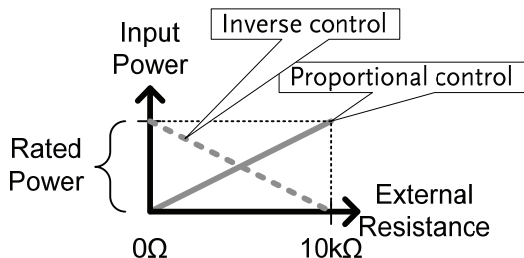

Note

The inverse configuration is recommended for safety reasons. In the event that any of the cables become accidentally disconnected, the current/voltage/power input will drop to the minimum. Under similar circumstances using proportional control, an unexpectedly high input would result.

## Operation

1. Turn the power off from the PEL-3000E and from the load.
2. Connect the external resistance across pins 1 and 3 of the J1 connector.
3. Turn the power on the PEL-3000E.
4. Set the operating mode and range.
  - See page 39 for CC mode.
  - See page 41 for CR mode.
  - See page 43 for CV mode.
  - See page 45 for CP mode.

5. Press **Main** > *Configure [F5]* > *Next Menu [F4]* > *External [F3]*.
6. Set the *Control* to *R* for proportional control or to *Rinv* for inverse control.
  - The J1 connector is now ready for external resistance control.

### Turning the Load On using External Control

**Description**                      The load can be turned on and off with an external switch connected to pins 7 and 12 of the J1 connector.

**Pin Inputs**                      Pin 7 of the J1 connector is internally pulled up to 5V with a 10kΩ resistor when the switch is open. Thus when the switch is open, pin 7 is logically high. When the switch is closed, pin 7 is pulled down to the A COM ground level, making pin 7 logically low.

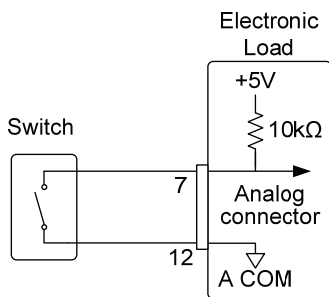

## Example

The LoadOn IN setting determines whether the load is turned on when the external switch is closed (low) or open (high).

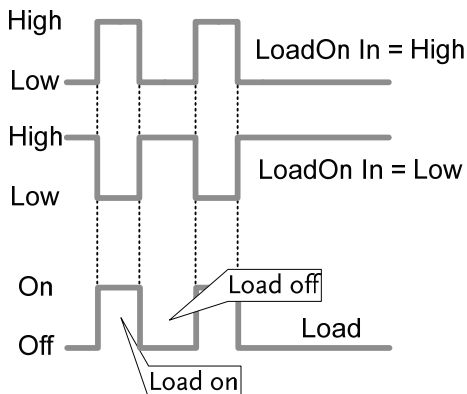

Operation:  
Configuration

1. Press **Main** > *Configure [F5]* > *Next Menu [F4]* > *External [F3]* and set the *LoadOn IN* setting.
  - Set to Low if you want the load to be turned on when the switch is closed.
  - Set to High if you want the load to turn on when the switch is open.



When external control is used to turn the load off, the load key cannot be used to turn the load on. However the reverse is not true. If the load has been turned on by external control, the load key can be used to turn the load off.

## Load On/Off Status

**Description** Pin 13 (Load On Status) of the J1 connector is used to monitor the load status (on or off).

**Pin out** The Load On Status pin is a photo-coupled open-collector output.

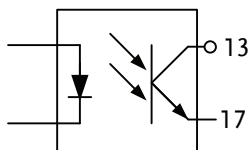

Photocoupler input: 30V max, 8mA, max.

## External Control of the Range

**Description** The range for the present operating mode can be externally controlled when the current range is set to high range.

The range is changed using pin 9 (Range Cont 0) and 12 (A Com) of the J1 connector. (Range Cont 1(pin 8) is not used.)

When externally controlling the range, the pin input combination determines which range is chosen.

Note: Press **Main** > *Configure [F5]* > *Next Menu [F4]* > *External [F3]* and set the *Control* setting to *V*, *R* or *Riv* to enable external control.

I Range	Pin 9
H	High
L	Low

**Pin Inputs** Pin 9 of the J1 connector is internally pulled up to 5V with a 10kΩ resistor when open. When closed, pin 9 is pulled down to the A COM ground level.

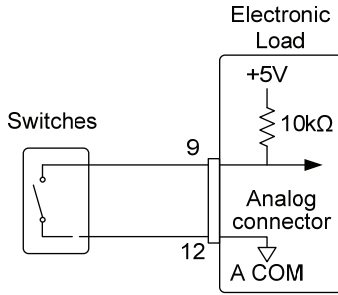

The range can only be externally controlled when the IRange has been set to High using the front panel controls.

### I Range Status

**Description** Pin 15 (Range Status 0) of the J1 connector is used to monitor the IRange status. (Range Status 1 (pin 14) is not used.)

I Range	Pin 15
H	Off
L	On

**Pin out** The Range Status pins are photo-coupled open-collector outputs.

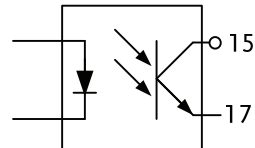

Photocoupler input: 30V max, 8mA, max.

## External Control of the Alarm

**Description** An alarm can be activated/ deactivated using external control with the J1 connector (pins 10, 12). When the alarm is activated, an EXT.AL message is also output. The alarm can be activated by an external device.

The alarm is activated by sending a low-level signal. The operating threshold level is TTL.

**Pin Inputs** Pin 10 is internally pulled up to 5V with a 10kΩ resistor when open. When closed, pin 10 is pulled down to the A COM ground level.

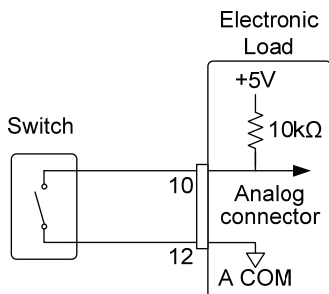

### Alarm Status

**Description** Pins 16 and 17 of the J1 connector are used to monitor whether the alarm is on or off.

**Pin out** The Alarm Status pin is a photo-coupled open-collector output.

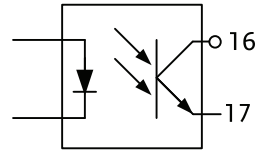

Photocoupler input: 30V max, 8mA, max.

### Short Control

**Description** The Short Signal Out pins (19 and 20) are 30VDC 1A relay contact outputs. These outputs can be used to drive an external relay to physically short the terminal outputs.

**Pin Inputs** The Short Signal Out pins are normally open until the short function is activated.

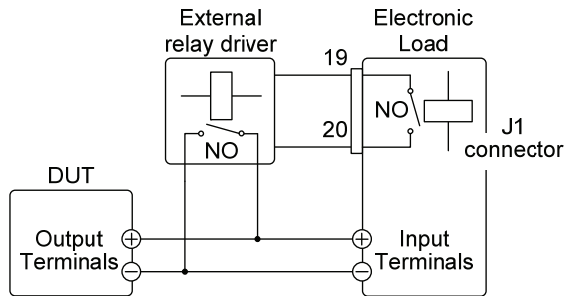

 **Note**

The external relay driver is not a standard accessory. Please provide your own external relay and driver circuit.

### Current Monitor Output

**Description** The voltage output from the IMON pin on the J1 connector is used to represent the current input level.

The voltage range used to represent the full scale current range from the IMON pin on the J1 connector depends on the current range settings.

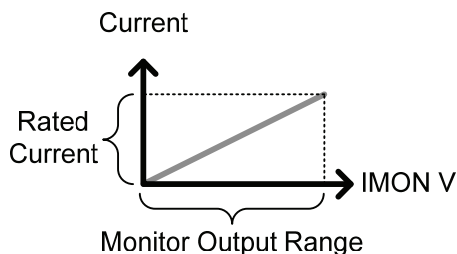

Monitor Connector	Current Range	Monitor Output Range
I MON (J1)	High	0 - 10V
I MON (J1)	Low	0 - 1V

**J1 Connector** The voltage across pins 2 and 3 outputs a voltage of 0-10V for the high current range and 0-1V for the low current ranges. The common potential is connected to A COM (negative load terminal).



## Trigger In/Out BNC

See page 65 to turn the trigger input or output on/off or to configure the trigger settings. The trigger input can configure the delay time while the trigger out pulse width can also be configured.

### Trigger Output

---

**Description** The trigger output signal is generated every time a switching operation is performed (i.e., Dynamic mode) or when a Fast or Normal Sequence is executed and the TRIG OUT parameter is enabled.

The trigger output signal from TRIG OUT BNC is a 4.5V pulse of at least 2 $\mu$ s with an impedance of 500 $\Omega$ . The common potential is connected to the chassis potential. The signal threshold level is TTL.

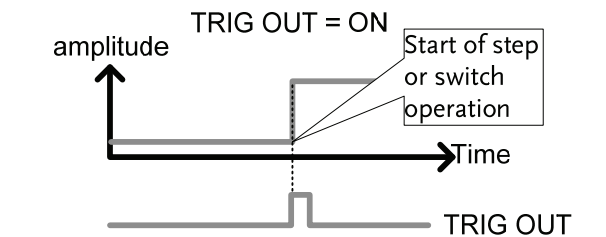

### Trigger Input

---

**Description** The TRIG IN BNC on the rear panel is used to resume a sequence after a pause. This action is useful to synchronize the execution of a sequence with another device. To resume a pause sequence, apply a high signal for 10 $\mu$ s or more. The TRIG IN BNC is pulled down to earth internally using a 100k $\Omega$  resistor.

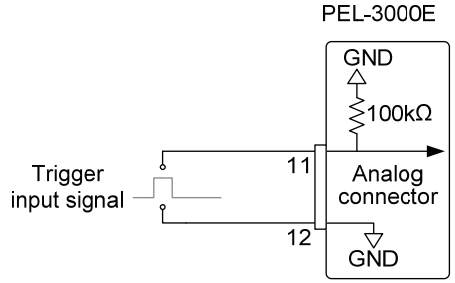

# RREMOTE CONTROL

This chapter describes basic configuration of IEEE488.2 based remote control. For a command list, refer to the programming manual, downloadable from GW Instek website, [www.gwinstek.com](http://www.gwinstek.com)

---

Interface Configuration .....	202
Configure to USB Remote Interface .....	202
Configure GPIB Interface.....	202
USB Remote Control Function Check.....	204
Using Realterm to Establish a Remote Connection .....	205
GPIB Function Check.....	209

## Interface Configuration

### Configure to USB Remote Interface

USB configuration	PC side connector	Type A, host
	PEL-3000E side connector	Rear panel Type B, slave
	Speed	2.0 (full speed)
	USB Class	USB CDC ACM





**Note**

Before USB can be used for remote control, it is necessary to install the PEL-3000E USB device driver, located on the accompanying User Manual CD.

Supported OS:

32 bit(x86): Windows 2000/XP/Vista/7/8

64 bit(x64): Windows XP/Vista/7/8

- Operation
1. Connect the USB cable to the rear panel USB B port.
  2. Press  +  > *Interface*[F3] and set the *Interface* setting to *USB*.

### Configure GPIB Interface

To use GPIB, the optional GPIB port must be installed. See page 216 for installation details.

- Operation
1. Ensure the PEL-3000E is off before proceeding.
  2. Connect a GPIB cable from a GPIB controller to

the GPIB port on the PEL-3000E.

3. Turn the PEL-3000E on.

4. Press **Shift** + **Help** <sup>Utility</sup> > *Interface*[F3] and set the *Interface* setting to *GPIB*.

5. Set the GPIB address.

GPIB address      0-30

- GPIB constraints
- *Maximum 15 devices altogether, 20m cable length, 2m between each device*
  - *Unique address assigned to each device*
  - *At least 2/3 of the devices turned On*
  - *No loop or parallel connection*

Pin Assignment

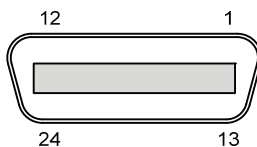

Pin	Signal	Pin	Signal
1-4	Data I/O 1-4	13-16	Data I/O 5-8
5	EOI	17	REN
6	DAV	18	Ground (DAV)
7	NRFD	19	Ground (NRFD)
8	NDAC	20	Ground (NDAC)
9	IFC	21	Ground (IFC)
10	SRQ	22	Ground (SRQ)
11	ATN	23	Ground (ATN)
12	SHIELD Ground	24	Single GND

## USB Remote Control Function Check

---

Functionality  
check

Invoke a terminal application such as  
Realterm.

The USB connection emulates a COM port on the PC. To check the COM port settings in Windows, see the Device Manager. For example, for Win 7 go to the Control panel → Hardware and Sound → Device Manager.

---



Note

If you are not familiar with using a terminal application to send/receive remote commands from a serial port or via a USB connection, please see page 205 (Using Realterm to Establish a Remote Connection) for more information.

---

Run this query command via the terminal after the instrument has been configured for USB remote control (page 202).

\*idn?

This should return the Manufacturer, Model number, Serial number, and Firmware version in the following format.

- *GW,PEL-303XE, XXXXXXXXXXXXX, V.X.X.X*

Manufacturer: GW

Model number : PEL-303XE

Serial number : XXXXXXXXXXXXX

Firmware version : V.X.X.X

---



Note

For further details, please see the programming manual, available on the GW Instek web site @ [www.gwinstek.com](http://www.gwinstek.com).

---

## Using Realterm to Establish a Remote Connection

---

**Background** Realterm is a terminal program that can be used to communicate with a device attached to the serial port of a PC or via an emulated serial port via USB.

The following instructions apply to version 2.0.0.70. Even though Realterm is used as an example to establish a remote connection, any terminal program can be used that has similar functionality.

---



Note

Realterm can be downloaded on Sourceforge.net free of charge.

For more information please see <http://realterm.sourceforge.net/>

---

- Operation**
1. Download Realterm and install according to the instructions on the Realterm website.
  2. Connect the PEL-3000E via USB (page 202).
  3. Go to the Windows device manager and find the COM port number for the connection. For example, go to the Start menu > Control Panel > Hardware and Sound > Device Manager.

Double click the *Ports* icon to reveal the connected serial port devices and the COM port for the each connected device.

If using USB, the baud rate, stop bit and parity settings can be viewed by right-clicking connected device and selecting the *Properties*

option.

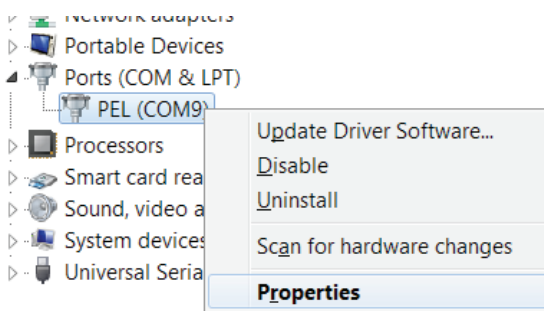

4. Start Realterm on the PC as an administrator.  
Click:  
Start menu>All Programs>RealTerm>realterm

Tip: to run as an administrator, you can right click the Realterm icon in the Windows Start menu and select the *Run as Administrator* option.



5. After Realterm has started, click on the *Port* tab.

Enter the *Baud*, *Parity*, *Data bits*, *Stop bits* and *Port* number configuration for the connection.

The *Hardware Flow Control*, *Software Flow Control* options can be left at the default settings.

Press *Open* to connect to the PEL-3000E.

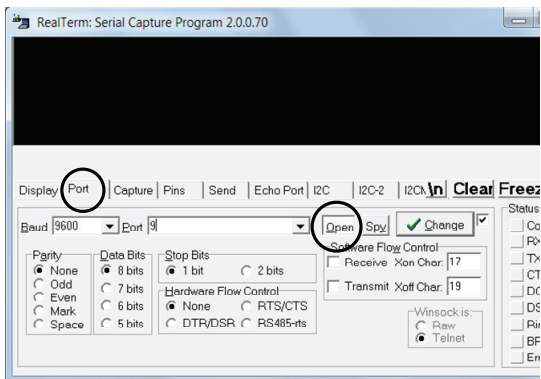

- Click on the *Send* tab.

In the *EOL* configuration, check on the *+CR* and *+LF* check boxes.

Enter the query:

*\*idn?*

Click on *Send ASCII*.

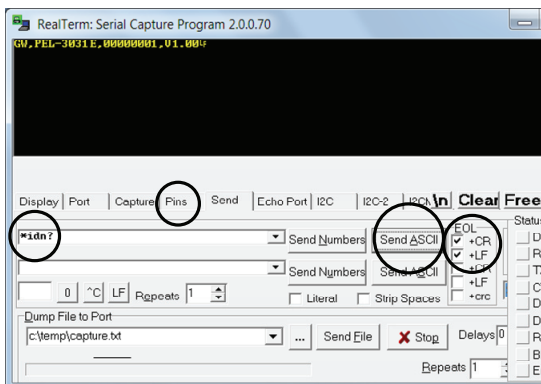

- The terminal display will return the following:

```
GW,PEL-303XE,XXXXXXXXXXXXX,
V.X.X.X.X
```

(manufacturer, model, serial number, version)

- If Realterm fails to connect to the PEL-3000E, please check all the cables and settings and try again.

## GPIB Function Check

Functionality check

Please use the National Instruments Measurement & Automation Controller software to confirm GPIB/LAN functionality.

See the National Instrument website, <http://www.ni.com> for details.



Note

For further details, please see the programming manual, available on the GW Instek web site @ [www.gwinstek.com](http://www.gwinstek.com).

Operation

1. Start the NI Measurement and Automation Explorer (MAX) program. Using Windows, press:



*Start>All Programs>National Instruments>Measurement & Automation*



2. From the Configuration panel access;  
My System>Devices and Interfaces>GPIB0

3. Press the *Scan for Instruments* button.
4. In the *Connected Instruments* panel the PEL-3000E should be detected as *Instrument 0* with the address the same as that configured on the PEL-3000E.
5. Double click the *Instrument 0* icon.

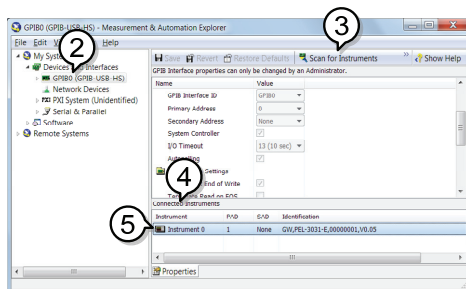

6. Click on the *Attributes* tab at the bottom of the screen.
7. Click on *Communicate with Instrument*.
8. In the *NI-488.2 Communicator* window, ensure *\*IND?* is written in the *Send String:* text box.

Click on the *Query* button to send the *\*IDN?* query to the instrument.

9. The *String Received* text box will display the query return:

*GW,PEL-303XE, XXXXXXXXXXXXX,  
V.X.X.X.X*

(manufacturer, model, serial number, version)

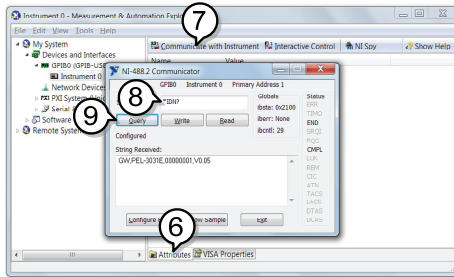

10. The function check is complete.

# FAQ

---

- The load voltage indicated on the load module is below expected.
- The front panel keys are not working.
- The load won't turn on.
- The performance does not match the specification

The load voltage indicated on the load module is below expected.

---

Ensure the load leads are as short as possible, twisted and use the appropriate wire gauge. Ensure that voltage sense is used, this can help alleviate the voltage drop across the load leads.

The front panel keys are not working.

---

Check to make sure that the key lock has not been activated. LOCK will be shown on the panel when the screen is locked. Press Shift + Lock to unlock the keys.

The load won't turn on.

---

If you are using the load key to try to turn the load on and the load won't turn on, it is possible that external control is activated and that the LoadOn In setting is set to low. See page 192 for details.

The performance does not match the specification.

---

Make sure the device is powered On for at least 30 minutes, within +20°C-+30°C. This is necessary to stabilize the unit to match the specification.

For more information, contact your local dealer or GWInstek at [www.gwinstek.com](http://www.gwinstek.com) / [marketing@goodwill.com](mailto:marketing@goodwill.com).

# APPENDIX

---

Replacing the Dust Filter .....	215
GPIB Installation .....	216
PEL-3000E Default Settings.....	217
Frame Control Connector Contacts .....	220
Operating Mode Description .....	222
CC Mode .....	222
CR Mode .....	223
CP Mode.....	224
CV Mode.....	226
Operating Area .....	227
PEL-3000E Specifications .....	229
Overall .....	229
Static Mode .....	229
Dynamic Mode .....	230
Measurement.....	231
Protective.....	232
General .....	233
Remote Sensing.....	233
Sequence Function.....	233
Other.....	233
Analog External Control.....	234
PEL-3000E Dimensions .....	236
Declaration of Conformity.....	237



## Replacing the Dust Filter

---

**Background**                      The dust filter should be replaced twice a year. Not replacing the filter will reduce performance and may cause the PEL-3000E to malfunction.

---

**Procedure**                      1. Turn the PEL-3000E off completely at the rear panel power switch.

Gently lift the grill up from the bottom.

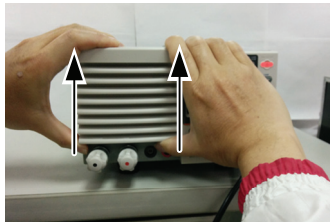

2. Remove the filter from the grill and replace with GW Instek part number: PEL-010.

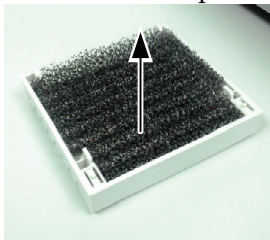

## GPIB Installation

---

**Background**                      GPIB is an optional extra. The following instructions describe how to install the optional GPIB card if necessary.

---

- Procedure**
1. Turn off the PEL-3000E.
  2. Remove the two screws holding the cover on the option bay.
  3. Slide the GPIB card onto the rails in the option bay.
  4. Re-screw the screws back into place.
- 

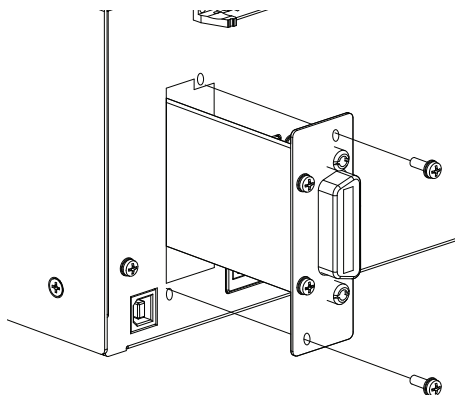

## PEL-3000E Default Settings

The following default settings are the factory configuration settings for the PEL-3000E.

Main Settings		
Item	Panel Settings	Setup Memory Settings (all 100 sets)
Current(CC)	0 A	0 A
Conductance(CR)	0 mS	0 mS
Voltage(CV)	Maximum value	Maximum value
Wattage(CP)	0 W	0 W
+CV	OFF	OFF
+CV Response	slow	slow
Current range	H	H
Voltage range	H	H
Load on/off	Load off	Load off
Operation mode	CC	CC
Slew rate	Maximum value of H range	Maximum value of H range
Preset memories	Settings above in each mode	Settings above in each mode
Main > Configure > Protection		
Item	Panel Settings	Setup Memory Settings (all 100 sets)
OCP Level	Maximum value	Maximum value
OCP Setting	LIMIT	LIMIT
OPP Level	Maximum value	Maximum value
OPP Setting	LIMIT	LIMIT
UVP value	OFF	OFF
OVP value	OFF	OFF

**Main > Configure > Other**

Item	Panel Settings	Setup Memory Settings (all 100 sets)
Soft Start	OFF	OFF
Von Voltage	0.00V	0.00V
Von Latch	ON	ON
Von Delay	2.0 ms	2.0 ms
Count Time(elapsed time display)	OFF	OFF
Cut Off Time	OFF	OFF
CR Unit	mS	mS
Dyna. Level	Value	Value
Dyna. Time	T1/T2	T1/T2
Mem.Recall	Direct	Direct
Short Function	ON	ON
Short Key	Toggle	Toggle
Short Safety	ON	ON

**Main > Configure > Go-NoGo**

Item	Panel Settings	Setup Memory Settings (all 100 sets)
SPEC. Test	OFF	OFF
Delay Time	0.0s	0.0s
Entry Mode	Value	Value
High	Max. V / Max. I	Max. V / Max. I
Low	Max. V / Max. I	Max. V / Max. I

**Main > Configure > Next Menu > Sync**

Item	Panel Settings	Setup Memory Settings (all 100 sets)
Trigger In	OFF	OFF
Trigger In Delay	0.0	0.0
Trigger Out	ON	ON
Trigger Out Width	10.0	10.0

## Main &gt; Configure &gt; Next Menu &gt; Knob

Item	Panel Settings		Setup Memory Settings (all 100 sets)	
	Model	PEL-3031E	PEL-3032E	PEL-3031E
Status	Step	Step	Step	Step
CCH Step	0.200 A	0.0500A	0.200 A	0.0500A
CCL Step	0.0200 A	0.00500A	0.0200 A	0.00500A
CRH Step	200 mS	20.0mS	200 mS	20.0mS
CRL Step	20.0 mS	2.00mS	20.0 mS	2.00mS
CVH Step	0.500 V	1.00V	0.500 V	1.00V
CVL Step	0.0500 V	0.100V	0.0500 V	0.100V
CPH Step	1.00 W	1.00W	1.00 W	1.00W
CPL Step	0.100 W	0.100W	0.100 W	0.100W

## Main &gt; Configure &gt; Next Menu &gt; External

Item	Panel Settings		Setup Memory Settings (all 100 sets)	
	Control	OFF		OFF
LoadOn IN	OFF		OFF	

## Frame Control Connector Contacts

### J1 Connector

Pin name	Pin number	Description
EXT R/V CONT	1	Used for voltage/resistance control of CC, CR, CV and CP mode.  0V to 10V corresponds to 0% to 100% of the rated current (CC mode), rated voltage (CV mode), or rated power (CP mode). 0V to 10V corresponds to the maximum resistance to minimum resistance (CR mode)  0Ω to 10kΩ corresponds to 0% to 100%(R control) or 100% to 0%(Rinv control) of the rated current (CC mode), rated voltage (CV mode), or rated power (CP mode). 0Ω to 10kΩ corresponds to maximum resistance to minimum resistance or minimum resistance to maximum resistance (CR mode)
IMON	2	Current monitor output 10 V f.s (H range) and 1 V f.s (L range)
A COM	3	Connected to the negative load input terminal then to the internal ground level.
Not connected	4	
Not connected	5	
Not connected	6	
LOAD ON/OFF CONT	7	Turns on the load with low (or high) TTL level signal Pulled up the internal circuit to 5 V using 10 kΩ.
RANGE CONT 1	8	External range switch input*1 *2
RANGE CONT 0	9	Pulled up the internal circuit to 5 V using 10 kΩ.
ALARM INPUT	10	Activates alarm with low TTL level signal input. Pulled up the internal circuit to 5 V using 10 kΩ.
Not connected	11	
A COM	12	Connected to the negative load input terminal then to the internal ground level.
LOAD ON STATUS	13	Turns on when load is on. Open collector output by a photocoupler.*4

---

RANGE STATUS 1	14	Range status output. Open collector output by a photocoupler.*4
RANGE STATUS 0	15	photocoupler.*4
ALARM STATUS	16	Turns on when an alarm (OVP, OCP, OPP, OTP, RVP, or UVP) is activated or when an external alarm is applied. Open collector output by a photocoupler.*4
STATUS COM	17	STATUS signal common for pins 13 to 16.
RESERVE	18	Reserved
SHORT SIGNAL OUT	19	Relay contact output (30 VDC/1 A)
SHORT SIGNAL OUT	20	

---

\*1 Valid only when the front panel settings are H range.

\*2

	RANGE CONT 0
H range	1
L range	0

\*3

	RANGE STATUS 0
H range	OFF
L range	ON

\*4 The maximum applied voltage of the photocoupler is 30 V; the maximum current is 8 mA.

---

## Operating Mode Description

### CC Mode

---

#### CC Mode

When the unit is set to CC mode it will operate as a constant current load when connected to a constant voltage source. This means the unit will sink a designated amount of current, up to the rated power level, regardless of the voltage. This is illustrated below.

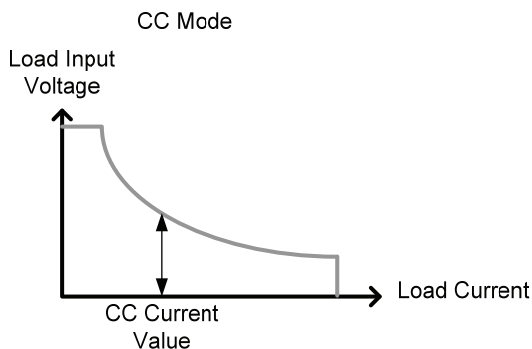

#### CC+CV Mode

When CC+CV mode is enabled, the unit will act as constant current load after the input voltage is greater than the user-defined CV level. At the CV level, the unit works as a constant voltage load. This mode effectively creates a voltage ceiling before the unit operates in CC mode. The diagram below illustrates this.



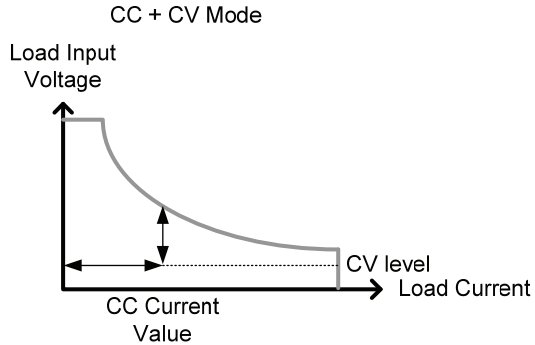

Note that when the source voltage is less than the CV level, no current will flow due to a very high impedance.

## CR Mode

---

### CR Mode

When the unit is set to CR mode it will operate as a constant resistance load when connected to a constant voltage source. This means the unit will maintain a set resistance, up to the rated power, regardless of the input voltage. When input voltage changes, the unit responds by changing the current load to maintain the set resistance according to ohm's law. This is illustrated below.

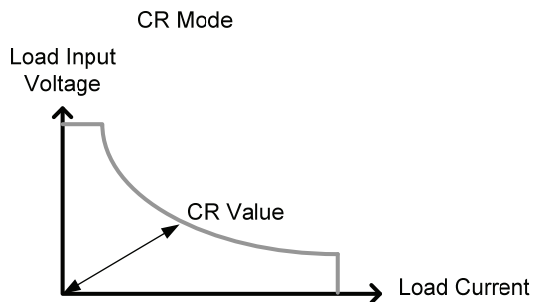

## CR+CV Mode

When CR+CV mode is enabled, the unit will act as constant resistive load after the input voltage is greater than the user-defined CV level. At the CV level, the unit works as a constant voltage load. This mode effectively creates a voltage ceiling before the unit operates in CR mode. The diagram below illustrates this.

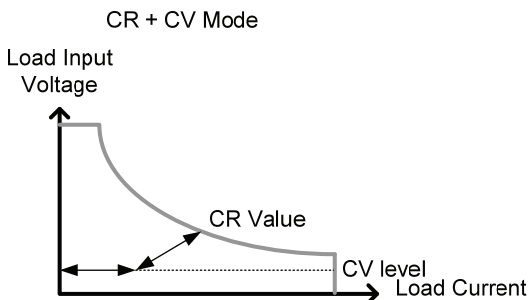

Note that when the source voltage is less than the CV level, no current will flow due to a very high impedance.

## CP Mode

---

### CP Mode

When the unit is set to CP mode it will operate as a constant power load when connected to a constant voltage source. This means the unit will maintain a set power level, up to the rated current or voltage level, regardless of the input voltage. When the input voltage changes, the unit responds by changing the current load to maintain the set power level accordingly ( $P=I \times V$ ). This is illustrated below.

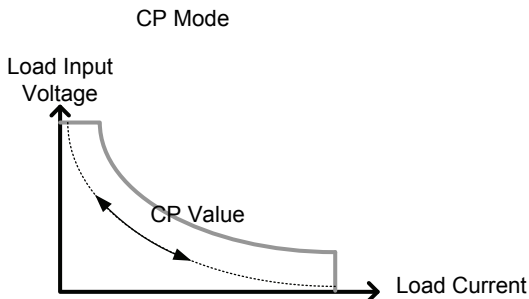

## CP+CV Mode

When CP+CV mode is enabled, the unit will act as a constant power load after the input voltage is greater than the user-defined CV level. At the CV level, the unit works as a constant voltage load. This mode effectively creates a voltage ceiling before the unit operates in CP mode. The diagram below illustrates this.

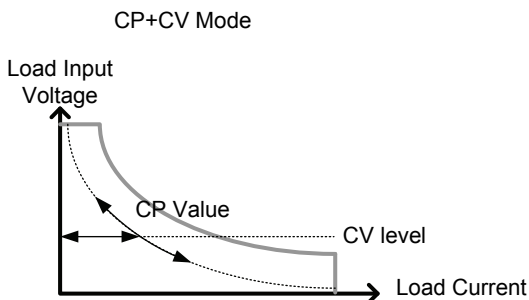

Note that when the source voltage is less than the CV level, no current will flow due to a very high impedance.

## CV Mode

---

### CV Mode

When the unit is set to CV mode it will operate as a constant voltage load when connected to a constant current source. This means the unit will maintain a set voltage level, up to the rated power, regardless of the input current. When the source voltage is less than the CV level, no current will flow due to a very high impedance. This is illustrated below.

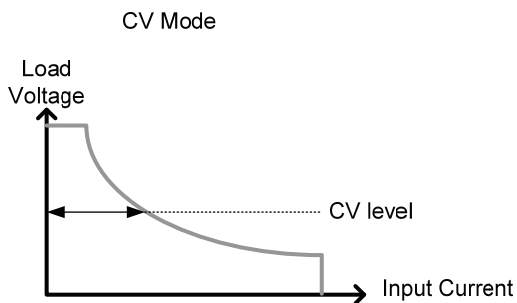

# Operating Area

PEL-3031E

High Range Chart

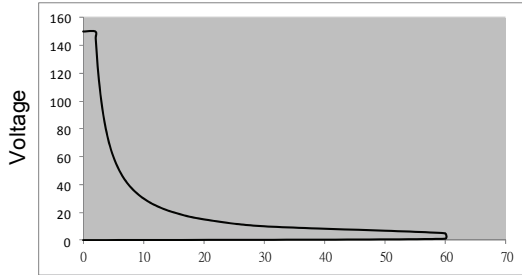

Current  
Low Range Chart

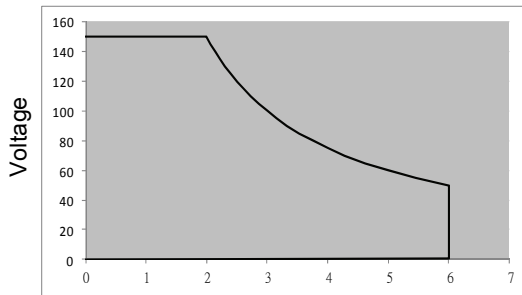

Current  
High Range Chart

PEL-3032E

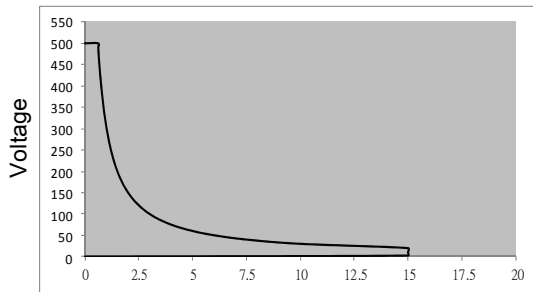

Current

Low Range Chart

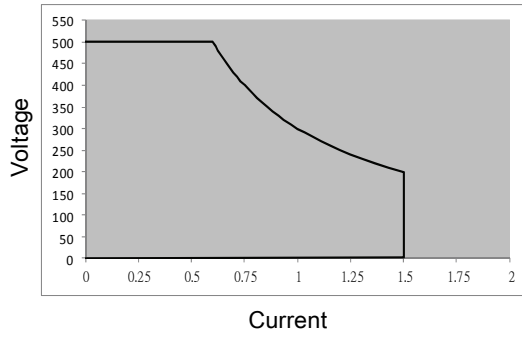

## PEL-3000E Specifications

The specifications apply when the PEL-3000E is powered on for at least 30 minutes to warm-up to a temperature of 20°C to 30°C, unless specified otherwise.

If operating with long cables, remote sense must be connected to the terminals.

### Overall

Model	PEL-3031E		PEL-3032E	
Power	300W			
Range	Low	High	Low	High
Voltage	1-150V	1-150V	2.5-500V	2.5-500V
Current	0-6A	0-60A	0-1.5A	0-15A
Min. Operating Voltage(dc)	1V-6A	1V-60A	2.5V-1.5A	2.5V-15A

### Static Mode

Model	PEL-3031E		PEL-3032E	
Range	Low	High	Low	High
<b>Constant Current Mode</b>				
Range	0-6A	0-60A	0-1.5A	0-15A
Setting Range	0-6.12A	0-61.2A	0-1.53A	0-15.3A
Resolution	0.2mA	2mA	0.05mA	0.5mA
Accuracy	$(T^{*1}) \pm (0.1\% \text{ of set} + 0.1\% \text{ of F.S}) + V_{in}/500k\Omega$ (Full scale of High range)	$(T^{*1}) \pm (0.1\% \text{ of set} + 0.2\% \text{ of F.S}) + V_{in}/500k\Omega$ (Full scale of High range)	$(T^{*1}) \pm (0.1\% \text{ of set} + 0.1\% \text{ of F.S}) + V_{in}/500k\Omega$ (Full scale of High range)	$(T^{*1}) \pm (0.1\% \text{ of set} + 0.2\% \text{ of F.S}) + V_{in}/500k\Omega$ (Full scale of High range)
<b>Constant Resistance Mode</b>				
Range	60S-0.002S(0.01666Ω-500Ω)(300W/15V)		6S-0.0002S(0.16666Ω-5kΩ)(300W/50V)	
	6S-0.0002S(0.16666Ω-5kΩ)(300W/150V)		0.6S-0.00002S(1.66666Ω-50kΩ)(300W/500V)	
Setting Range	60S-0.002S(0.01666Ω-500Ω)(300W/15V)		6S-0.0002S(0.16666Ω-5kΩ)(300W/50V)	

	6S-0.0002S(0.1666Ω-5kΩ)(300W/150V)	0.6S-0.00002S(1.6666Ω-50kΩ)(300W/500V)
Resolution (30000 steps)	0.002S(15V) 0.0002S(150V)	0.0002S(50V) 0.00002S(500V)
Accuracy	(T <sup>*1</sup> ) ± (0.3% of set + 0.6S) + 0.002mS	(T <sup>*1</sup> ) ± (0.3% of set + 0.06S) + 0.002mS

**Constant Voltage Mode**

Range	1-15V	1-150V	2.5-50V	2.5-500V
Setting Range	0-15.3V	0-153V	0-51V	0-510V
Resolution	0.5mV (T <sup>*1</sup> ) ± (0.1% of set + 0.1% of F.S)	5mV (T <sup>*1</sup> ) ± (0.1% of set + 0.1% of F.S)	1mV (T <sup>*1</sup> ) ± (0.1% of set + 0.1% of F.S)	10mV (T <sup>*1</sup> ) ± (0.1% of set + 0.1% of F.S)
Accuracy	(Full scale of Low range)	(Full scale of High range)	(Full scale of Low range)	(Full scale of High range)
Input Current Variation *2	12mV		40mV	

**Constant Power Mode**

Range	0W-30W (6A)	0W-300W (60A)	0W-30W (1.5A)	0W-300W (15A)
Setting range	0W-30.6W	0W-306W	0W-30.6W	0W-306W
Resolution	1mW	10mW	1mW	10mW
Accuracy	(T <sup>*1</sup> ) ± (0.6 % of set + 1.4 % of f.s (Full scale of H range)) + Vin <sup>2</sup> /500kΩ			

\*1: If the ambient temperature is over 30 °C or below 20 °C, then T = ± |t-25 °C| x 100ppm/°C x Set. If the ambient is in the range of 20 ~ 30°C, then T = 0 (t is the ambient temperature)

\*2: With respect to a change in the current of 10% to 100% of the rating at an input voltage of 1V(during remote sensing).

**Dynamic Mode**

Model	PEL-3031E		PEL-3032E	
Range	Low	High	Low	High
General				
T1 & T2	0.05ms - 30ms / Res : 1us 30ms - 30s / Res : 1ms			
Accuracy	1us / 1ms ± 200ppm			
Slew Rate (Accuracy 10%)	0.001 - 0.25A/us	0.01 - 2.5A/us	0.25mA - 62.5mA/us	2.5mA - 625mA/us
Slew Rate Resolution	0.001A/us	0.01A/us	0.25mA/us	2.5mA/us



Slew Rate Accuracy of Setting*1	$\pm(10\% + 15\mu s)$			
<b>Constant Current Mode</b>				
Current	0-6A	0-60A	0-1.5A	0-15A
Setting range	0-6.12A	0-61.2A	0-1.53A	0-15.3A
Current Resolution	0.2mA	2mA	0.05mA	0.5mA
Current Accuracy	$\pm 0.8\%$ F.S.			
<b>Constant Resistance Mode</b>				
Resistance	60S-0.002S(0.01666 $\Omega$ -500 $\Omega$ )(300W/15V)		6S-0.0002S(0.16666 $\Omega$ -5k $\Omega$ )(300W/50V)	
Setting Range	60S-0.002S(0.01666 $\Omega$ -500 $\Omega$ )(300W/15V)		6S-0.0002S(0.16666 $\Omega$ -5k $\Omega$ )(300W/50V)	
Resistance Resolution	30000 Steps			
Resistance Accuracy	$(T^{*1}) \pm (1\% \text{ of set} + 0.6S) + 0.002mS$		$(T^{*1}) \pm (1\% \text{ of set} + 0.06S) + 0.002mS$	

\*1: Time to reach from 10 % to 90 % when the current is varied from 2 % to 100 % (20 % to 100 % in L range) of the rated current.

## Measurement

Model	PEL-3031E		PEL-3032E	
Range	Low	High	Low	High
<b>Voltage Readback</b>				
Range	0-15V	0-150V	0-50V	0-500V
Resolution	0.5mV	5mV	2mV	20mV
Accuracy	$(T^{*1}) \pm (0.1\% \text{ of rdg} + 0.1\% \text{ of F.S})$ (Full scale of Low range)	$(T^{*1}) \pm (0.1\% \text{ of rdg} + 0.1\% \text{ of F.S})$ (Full scale of High range)	$(T^{*1}) \pm (0.1\% \text{ of rdg} + 0.1\% \text{ of F.S})$ (Full scale of Low range)	$(T^{*1}) \pm (0.1\% \text{ of rdg} + 0.1\% \text{ of F.S})$ (Full scale of High range)
<b>Current Readback</b>				
Range	0-6A	0-60A	0-1.5A	0-15A
Resolution	0.2mA	2mA	0.05mA	0.5mA
Accuracy	$(T^{*1}) \pm (0.1\% \text{ of rdg} + 0.1\% \text{ of F.S})$ (Full scale of High range)	$(T^{*1}) \pm (0.1\% \text{ of rdg} + 0.2\% \text{ of F.S})$ (Full scale of High range)	$(T^{*1}) \pm (0.1\% \text{ of rdg} + 0.1\% \text{ of F.S})$ (Full scale of High range)	$(T^{*1}) \pm (0.1\% \text{ of rdg} + 0.2\% \text{ of F.S})$ (Full scale of High range)

\*1: If the ambient temperature is over 30 °C or below 20 °C, then  $T = \pm |t-25^{\circ}\text{C}| \times 100\text{ppm}/^{\circ}\text{C} \times \text{Set}$ . If the ambient is in the range of 20 ~ 30°C, then  $T = 0$  (t is the ambient temperature)

## Protective

Model	PEL-3031E	PEL-3032E
<b>Over Power Protection (OPP)</b>		
Range	3-315W	
Resolution	10mW	
Accuracy	$\pm(2\%\text{set} + 1.5\%\text{F.S})$	
Status	Load off or limit selectable	
<b>Over Current Protection (OCP)</b>		
Range	0.3A-63A	0.075A-15.75A
Resolution	2mA	0.5mA
Accuracy	$\pm(2\%\text{set} + 0.25\%\text{F.S})$	
Status	Load off or limit selectable	
<b>Over Voltage Protection (OVP)</b>		
Turns the load off at 105% of the rated voltage.		
<b>Under Voltage Protection (UVP)</b>		
Turns off the load when detected.		
High voltage range	0.005V~153V or Off	0.01V~510V or Off
Low voltage range	0.0005V~15.3V or Off	0.001V~51V or Off
<b>Over Temperature Protection (OTP)</b>		
Status	Turns off the load when the heat sink temperature reaches 85 °C	
<b>Rated Over Power Protection (ROPP)</b>		
Value	330W	
Accuracy	$\pm 2\%$ of rated power	
Status	Load OFF	
<b>Rated Over Current Protection (ROCP)</b>		
An ROCP message will be produced when the input current range is greater than 110% of the rated operating current range (I range).		
Accuracy	$\pm 2\%$ of rated current	
Status	Load OFF	
<b>Reverse Voltage Protection (RVP)</b>		
By diode. Turns off the load when an alarm occurs.		

## General

Model	PEL-3031E		PEL-3032E	
Range	Low	High	Low	High
<b>Short Circuit</b>				
Current(CC)	≐ 6A	≐ 60A	≐ 1.5A	≐ 15A
Voltage(CV)	≐ 0V	≐ 0V	≐ 0V	≐ 0V
Resistance(CR)	≐ 0.1666Ω	≐ 0.01666Ω	≐ 1.666Ω	≐ 0.1666Ω
Input Resistance (Load Off)	≐ 500kΩ(Typical)			

## Remote Sensing

Voltage that can be compensated: 2V for a single line

## Sequence Function

<b>Normal Sequence</b>	
Operation mode	CC, CR, CV, or CP
Maximum number of steps	1000
Step execution time	1 ms - 999 h 59 min 59s
Time resolution	1 ms (1 ms ~ 1 min)/100ms (1 min ~ 1 h)/1s (1 h ~ 10 h)/10 s (10 h~ 100 h)/1 min (100 h ~ 999 h 59 min)
<b>Fast Sequence</b>	
Operation mode	CC or CR
Maximum number of steps	1000
Step execution time	25us - 600ms
Time resolution	1us (25us-60ms) / 10us (60.01ms-600ms)

## Other

Elapsed Time Delay	Measures the time from load on to load off. On/Off selectable.
Auto Load Off Timer	Automatically turns off the load after a specified time elapses. Can be set in the range of 1 s to 999 h 59 min 59 s or off

Rear Panel BNC Connector	
TRIG OUT	Trigger output: Approx. 4.5 V, pulse width: Approx. 2 $\mu$ s, output impedance: Approx. 500 $\Omega$ Outputs a pulse during sequence operation and switching operation.
TRIG IN	When a sequence is paused, the pause will be released when a high level TTL signal is applied for 10 us or longer. Pulled down the internal circuit to GND using 100k $\Omega$ .
Communication	
GPIB	Optional
USB	Standard

## Analog External Control

External Voltage Control	
	Operates in CC, CR, CP, or CV mode 0 V to 10 V correspond to 0 % to 100 % of the rated current (CC mode), rated voltage (CV mode), or rated power (CP mode). 0 V to 10 V correspond to maximum resistance to minimum resistance (CR mode)
External Resistance Control	
	Operates in CC, CR, CP, or CV mode 0 $\Omega$ to 10 k $\Omega$ correspond to 0 % to 100 % or 100 % to 0 % of the rated current (CC mode), rated voltage (CV mode), or rated power (CP mode). 0 $\Omega$ to 10 k $\Omega$ correspond to maximum resistance to minimum resistance or minimum resistance to maximum resistance (CR mode)
Current Monitor Output	
	10 V f.s (H range) and 1 V f.s (L range)
Load on/off Control Input	
	Turn on the load with low (or high) TTL level signal
Range Switch Input	
	Switch ranges L, H using a 1-bit signal*2
Alarm Input	
	Activate alarm with low TTL level signal input
Load on Status Output	
	On when the load is on (open collector output by a photocoupler)
Range Status Output	
	Outputs range L, H using 1-bit signal*3 (open collector output by a photocoupler)

---

**Alarm Status Output**

---

On when OVP, OCP, OPP, OTP, UVP, RVP, or when an external alarm input is applied (open collector output by a photocoupler)

---

**Short Signal Output**

---

Relay contact output (30 VDC/1 A)

---

\*1: Valid only when the front panel settings is H range.

---

\*2:

	RANGE CONT 0
H range	1
L range	0

---

\*3:

	RANGE STATUS 0
H range	OFF
L range	ON

---

\*4: The maximum applied voltage of the photocoupler is 30 V; the maximum current is 8 mA.

---

## PEL-3000E Dimensions

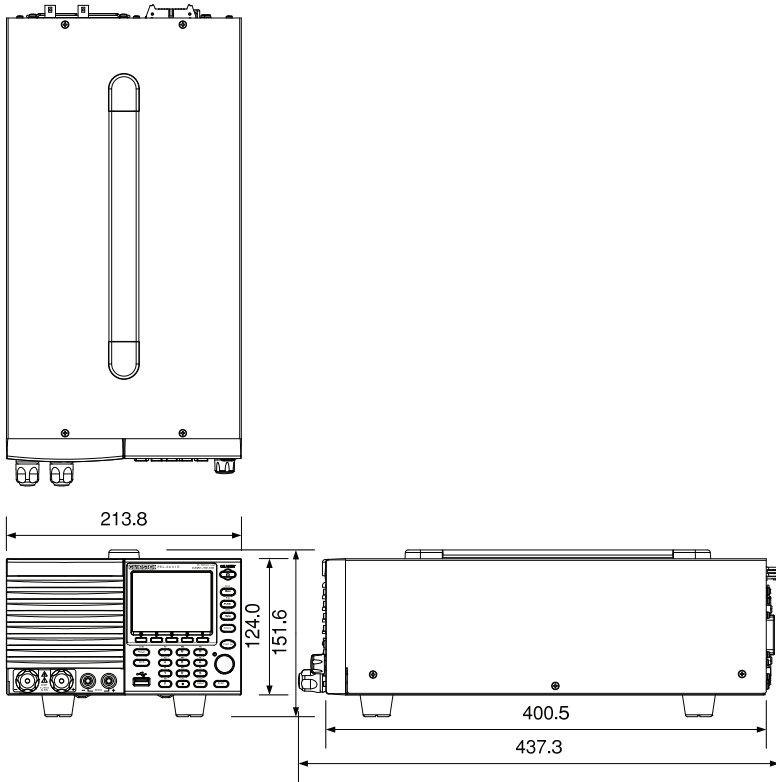

## Declaration of Conformity

We

**GOOD WILL INSTRUMENT CO., LTD.**

declare that the below mentioned product

**Type of Product:** Programmable Electronic Load

**Model Number:** PEL-3000E

is herewith confirmed to comply with the requirements set out in the Council Directive on the Approximation of the Laws of the Member States relating to Electromagnetic Compatibility (2014/30/EU) and Low Voltage Directive (2014/35/EU).

For the evaluation regarding the Electromagnetic Compatibility and Low Voltage Directive, the following standards were applied:

© EMC

EN 61326-1 EN 61326-2-1	Electrical equipment for measurement, control and laboratory use -- EMC requirements (2013)
Conducted & Radiated Emission EN 55011: 2009+A1:2010 Class A	Electrical Fast Transients EN 61000-4-4: 2012
Current Harmonics EN 61000-3-2: 2014	Surge Immunity EN 61000-4-5: 2006
Voltage Fluctuations EN 61000-3-3: 2013	Conducted Susceptibility EN 61000-4-6: 2014
Electrostatic Discharge EN 61000-4-2: 2009	Power Frequency Magnetic Field EN 61000-4-8: 2010
Radiated Immunity EN 61000-4-3: 2006+A1:2008+A2:2010	Voltage Dip/ Interruption EN 61000-4-11: 2004
Low Voltage Equipment Directive 2014/35/EU	
Safety Requirements	EN 61010-1: 2010 EN 61010-2-030: 2010

GOOD WILL INSTRUMENT CO., LTD.

No. 7-1, Jhongsing Road, Tucheng Dist., New Taipei City 236, Taiwan

Tel: +886-2-2268-0389

Fax: +866-2-2268-0639

Web: [www.gwinstek.com](http://www.gwinstek.com)

Email: [marketing@goodwill.com.tw](mailto:marketing@goodwill.com.tw)

GOOD WILL INSTRUMENT (SUZHOU) CO., LTD.

No. 521, Zhujiang Road, Snd, Suzhou Jiangsu 215011, China

Tel: +86-512-6661-7177

Fax: +86-512-6661-7277

Web: [www.instek.com.cn](http://www.instek.com.cn)

Email: [marketing@instek.com.cn](mailto:marketing@instek.com.cn)

GOOD WILL INSTRUMENT EURO B.V.

De Run 5427A, 5504DG Veldhoven, The Netherlands

Tel: +31(0)40-2557790

Fax: +31(0)40-2541194

Email: [sales@gw-instek.eu](mailto:sales@gw-instek.eu)

# INDEX

Accessories .....	10	Default settings .....	217
Advanced configuration		operation.....	125
Alarm tone.....	79	User.....	126
Auto Load.....	63	Display diagram .....	19
Control settings.....	80	Disposal instructions.....	6
Count time.....	61	Disposal symbol.....	3
Cut off time.....	62	Dynamic mode frequency .....	55
Display .....	79	EN61010	
Dyna. Time .....	55	Measurement category .....	4
Go-NoGo.....	81	Pollution degree .....	5
Language .....	80	Environment	
Load Off (Mode).....	64	Safety instruction.....	5
Load Off (Range).....	64	External control	
OCP.....	72	Alarm.....	196
OPP.....	73	Alarm status .....	197
OVP.....	76	Current monitor.....	198
Protection settings.....	72	Current range.....	194
Short enable/disable.....	65	Current status .....	195
Short(safety) .....	65	Load status .....	194
Soft start .....	58	Overview .....	183
Speaker.....	78	Resistance control.....	187
Step resolution.....	69	Short control.....	197
System settings .....	78	Trigger input .....	199
Trigger in delay .....	67	Trigger signal output.....	199
Trigger in status.....	67	Turning the load on .....	192
Trigger out status .....	67	Voltage control.....	184
Trigger out width .....	68	External control.....	182
UVP.....	75	FAQ .....	212
Von delay.....	61	Fast Sequence	
Von latch.....	60	Configuration.....	107, 157
Von voltage .....	59	Data edit.....	108, 158
Alarm Tone .....	79	Overview .....	103, 153
Analog connector		Run.....	110, 160
pin assignment.....	183	File Utility.....	123
Caution symbol.....	3	Firmware update .....	27
Cleaning the instrument.....	5	First time use instructions .....	20
Conventions .....	29	Front panel diagram.....	12
CV Response rate .....	56	Function	
Declaration of conformity .....	237	Count Time.....	132



Load.....	130	CV mode.....	43
Ring Time .....	131	CV Response rate .....	56
Select.....	128	Dynamic mode.....	51
Go_NoGo Tone .....	79	Dynamic mode units.....	54
GPIB installation.....	216	panel lock.....	50, 66
Ground		Short key .....	49
Symbol.....	3	Short key configuration.....	50
Help .....	35	Slew rate.....	55
Input terminals		Staticmode .....	51
Front .....	25	Turning the load on .....	48
Knob configuration		OPP alarm .....	73
Cursor.....	69	OVP alarm .....	76
Step .....	70	Package contents.....	11
Load default settings.....	21	Power supply	
Load wiring.....	23	Safety instruction.....	5
Connection.....	24	Power up.....	20
Main features.....	9	Preset .....	125
Mainframe operation		Presets	
OCP test automation..	162, 168, 174	Save/Recall .....	124
Marketing		Program	
Contact .....	213	Chain .....	90, 139, 152
Memory Recall		Configuration.....	86, 133, 136
safety setting .....	122	Overview .....	84, 134
Monitor signal output.....	199	Run.....	91, 140
Normal Sequence		Rear panel diagram .....	16
Configuration.....	98, 147	Remote control .....	201
Data edit.....	99, 149	GPIB configuration.....	202
Overview .....	93, 142	USB configuration .....	202
Run.....	101, 151	Remote control function	
OCP alarm .....	72	check.....	204
OCP test automation	162, 168, 174	GPIB.....	209
Operating area		Realterm.....	205
PEL-3031E.....	227	Remote sense .....	26
Operating mode		Replace the dust filter.....	215
CC .....	222	Restore default settings.....	125
CC+CV .....	222	Safety short .....	65
CP.....	224	Save/Recall.....	112
CP+CV.....	225	File types.....	113
CR.....	223	Presets .....	124
CR+CV .....	224	Recall from memory .....	119
CV .....	226	Recall from USB.....	120
Operation.....	39	Recall Safety .....	122
+CV mode.....	46	Save to internal memory .....	115
CC mode .....	39	Save to USB .....	116
CP mode.....	45	Sequence.....	93, 142
CR mode .....	41	Service operation	
CR units.....	43	About disassembly.....	4

Contact .....	213	UnReg alarm .....	77
Short enable/disable .....	65	Unreg Tone .....	79
Specifications		UVP alarm .....	75
Dimensions .....	236	Warning symbol .....	3
Frequency .....	229	Wire gauge .....	21
Trigger .....	67	Theory .....	22
UK power cord .....	7		