

DC Power Supply

GPD-X303S Series

USER MANUAL

GW INSTEK PART NO. 82PD-433SoM01



ISO-9001 CERTIFIED MANUFACTURER

GW INSTEK

This manual contains proprietary information, which is protected by copyrights. All rights are reserved. No part of this manual may be photocopied, reproduced or translated to another language without prior written consent of Good Will company.

The information in this manual was correct at the time of printing. However, Good Will continues to improve products and reserves the rights to change specification, equipment, and maintenance procedures at any time without notice.

Table of Contents

SAFETY INSTRUCTIONS	5
OVERVIEW	10
Introduction	10
Series Lineup / Main Features	13
Principle of Operation	14
Front Panel Overview	16
Rear Panel Overview	21
CV/CC Crossover Characteristics	22
SETUP	23
Power Up	23
Load Cable Connection	24
Output On/Off	25
Beep On/Off	25
Switch between channels	26
Front Panel Lock	26
OPERATION	27
CH1/CH2 Independent Mode	27
CH3 Independent Mode	29
CH4 Independent Mode	31
CH1/CH2 Tracking Series Mode	33
CH1/CH2 Tracking Parallel Mode	39
SAVE/RECALL SETUP	41
Save Setup	41
Recall Setup	42
REMOTE CONTROL	43
Remote Control Setup	43

Remote Connection Step.....	44
Command Syntax	46
Error Messages	46
Command List.....	47
Command Details	48
FAQ	53
APPENDIX	54
Fuse Replacement	54
Specifications	55
Declaration of Conformity.....	57
INDEX.....	58

S SAFETY INSTRUCTIONS

This chapter contains important safety instructions that you must follow when operating the GPD-X303S series and when keeping it in storage. Read the following before any operation to insure your safety and to keep the best condition for the GPD-X303 series.

Safety Symbols

These safety symbols may appear in this manual or on the GPD-X303S series.



WARNING

Warning: Identifies conditions or practices that could result in injury or loss of life.



CAUTION

Caution: Identifies conditions or practices that could result in damage to the GPD-X303S series or to other properties.



DANGER High Voltage



Attention Refer to the Manual



Protective Conductor Terminal



Earth (ground) Terminal



Do not dispose electronic equipment as unsorted municipal waste. Please use a separate collection facility or contact the supplier from which this instrument was purchased.

Safety Guidelines

General Guidelines



CAUTION

- Do not place any heavy object on the GPD-X303S series.
- Avoid severe impacts or rough handling that leads to damaging the GPD-X303S series.
- Do not discharge static electricity to the GPD-X303S series.
- Do not block or obstruct the cooling fan vent opening.
- Do not perform measurement at circuits directly connected to Mains (see note below).
- Do not disassemble the GPD-X303S series unless you are qualified as service personnel.

(Measurement categories) EN 61010-1:2001 specifies the measurement categories and their requirements as follows. The GPD-X303S series falls under category I.

- Measurement category IV is for measurement performed at the source of low-voltage installation.
- Measurement category III is for measurement performed in the building installation.
- Measurement category II is for measurement performed on the circuits directly connected to the low voltage installation.
- Measurement category I is for measurements performed on circuits not directly connected to Mains.

Power Supply



WARNING

- AC Input voltage: 100V/120V/220V/230V ±10%, 50/60Hz
- Connect the protective grounding conductor of the AC power cord to an earth ground, to avoid electrical shock.

Fuse

**WARNING**

- Fuse type: 100V/120V: T6.3A/250V, 220V/230V: T3.15A/250V
 - Make sure the correct type of fuse is installed before power up.
 - To ensure fire protection, replace the fuse only with the specified type and rating.
 - Disconnect the power cord before fuse replacement.
 - Make sure the cause of fuse blowout is fixed before fuse replacement.
-

Cleaning the
GPD-X303S
series

- Disconnect the power cord before cleaning.
 - Use a soft cloth dampened in a solution of mild detergent and water. Do not spray any liquid.
 - Do not use chemicals or cleaners containing harsh products such as benzene, toluene, xylene, and acetone.
-

Operation
Environment

- Location: Indoor, no direct sunlight, dust free, almost non-conductive pollution (note below)
 - Relative Humidity: < 80%
 - Altitude: < 2000m
 - Temperature: 0°C to 40°C
-

(Pollution Degree) EN 61010-1:2001 specifies the pollution degrees and their requirements as follows. The GPD-X303S series falls under degree 2.

Pollution refers to “addition of foreign matter, solid, liquid, or gaseous (ionized gases), that may produce a reduction of dielectric strength or surface resistivity”.

- Pollution degree 1: No pollution or only dry, non-conductive pollution occurs. The pollution has no influence.
- Pollution degree 2: Normally only non-conductive pollution occurs. Occasionally, however, a temporary conductivity caused by condensation must be expected.
- Pollution degree 3: Conductive pollution occurs, or dry, non-conductive pollution occurs which becomes conductive due to condensation which is expected. In such conditions, equipment is normally protected against exposure to direct sunlight, precipitation, and full wind pressure, but neither temperature nor humidity is controlled.

Storage environment

- Location: Indoor
- Relative Humidity: < 70%
- Temperature: -10°C to 70°C

Disposal



Do not dispose this instrument as unsorted municipal waste. Please use a separate collection facility or contact the supplier from which this instrument was purchased. Please make sure discarded electrical waste is properly recycled to reduce environmental impact.

Power cord for the United Kingdom

When using the GPD-2303S/GPD-3303S/GPD-4303S series in the United Kingdom, make sure the power cord meets the following safety instructions.

NOTE: This lead/appliance must only be wired by competent persons



WARNING: THIS APPLIANCE MUST BE EARTHED

IMPORTANT: The wires in this lead are coloured in accordance with the following code:

Green/ Yellow:	Earth
Blue:	Neutral
Brown:	Live (Phase)



As the colours of the wires in main leads may not correspond with the colours marking identified in your plug/appliance, proceed as follows:

The wire which is coloured Green & Yellow must be connected to the Earth terminal marked with the letter E or by the earth symbol \oplus or coloured Green or Green & Yellow.

The wire which is coloured Blue must be connected to the terminal which is marked with the letter N or coloured Blue or Black.

The wire which is coloured Brown must be connected to the terminal marked with the letter L or P or coloured Brown or Red.

If in doubt, consult the instructions provided with the equipment or contact the supplier.

This cable/appliance should be protected by a suitably rated and approved HBC mains fuse: refer to the rating information on the equipment and/or user instructions for details. As a guide, cable of 0.75mm² should be protected by a 3A or 5A fuse. Larger conductors would normally require 13A types, depending on the connection method used.

Any moulded mains connector that requires removal /replacement must be destroyed by removal of any fuse & fuse carrier and disposed of immediately, as a plug with bared wires is hazardous if a engaged in live socket. Any re-wiring must be carried out in accordance with the information detailed on this label.

OVERVIEW

This chapter describes the GPD-2303S/GPD-3303S/GPD-4303S series in a nutshell, including its main features and front / rear panel introduction. After going through the overview, follow the Setup chapter (page23) to properly power up and set operation environment.

Introduction

Overview

The GPD-X303S regulated DC power supply series are light weight, adjustable, multifunctional work stations. The GPD-2303S has a 2 independent adjustable voltage outputs. The GPD-3303S three independent outputs: two with adjustable voltage levels and one with fixed level selectable from 2.5V, 3.3V and 5V. The GPD-4303S has four independent voltage outputs that are all fully adjustable. The GPD-X303S series can be used for logic circuits where various output voltage or current are needed, and for tracking mode definition systems where plus and minus voltages with insignificant error are required.

Independent / Tracking Series / Tracking Parallel The three output modes of GPD-X303S series, independent, tracking series, and tracking parallel, can be selected through pressing the TRACKING key on the front panel. In the independent mode, the output voltage and current of each channel are controlled separately. The isolation degree, from output terminal to chassis or from output terminal to output terminal, is 500V. In the tracking modes, both the CH1 and CH2 outputs are automatically connected in series or parallel; no need to connect output leads. In the series mode, the output voltage is doubled; in the parallel mode, the output current is doubled.

Constant Voltage/ Constant Current Each output channel is completely transistorized and well-regulated, and works in constant voltage (CV) or constant current (CC) mode. Even at the maximum output current, a fully rated, continuously adjustable output voltage is provided. For a big load, the power supply can be used as a CV source; while for a small load, a CC source. When in the CV mode (independent or tracking mode), output current (overload or short circuit) can be controlled via the front panel. When in the CC mode (independent mode only), the maximum (ceiling) output voltage can be controlled via the front panel. The power supply will automatically cross over from CV to CC operation when the output current reaches the target value. The power supply will automatically cross over from CC to CV when the output voltage reaches the target value. For more details about CV/CC mode operation, see page22.

Automatic tracking mode The front panel display (CH1, CH2) shows the output voltage or current. When operating in the tracking mode, the power supply will automatically connect to the auto- tracking mode.

Dynamic load When used in audio production lines, the power supply can provide a continuous or dynamic load using a jumper connector (JP101/JP401). When the jumper connectors are connected to the "ON" position (shorted), a stable DC current power will be provided for audio power amplifiers.

Series Lineup / Main Features

Main Features

Performance	<ul style="list-style-type: none">• Low noise: Temperature controlled cooling fan• Compact size, light weight
Operation	<ul style="list-style-type: none">• Constant Voltage / Constant Current operation• Tracking Series / Tracking parallel operation• Output On/Off control• Multi-output: GPD-2303S: 30V/3A x2; GPD-3303S: 30V/3A x2, 2.5V/3.3V/5V/3A x 1 GPD-4303S: 30V/3A x2, 5V/1A x1, 5V/3A (10V/1A) x1• Digital panel control• 4 sets of panel setup save/recall• Coarse and fine Voltage/Current control• Software calibration• Buzzer output• Key lock function
Protection	<ul style="list-style-type: none">• Overload protection• Reverse polarity protection• Overvoltage protection
Interface	<ul style="list-style-type: none">• USB for remote control

Principle of Operation

- Overview The power supply consists of the following.
- AC input circuit
 - Transformer
 - Bias power supply including rectifier, filter, pre-regulator and reference voltage source
 - Main regulator circuit including the main rectifier and filter, series regulator, current comparator, voltage comparator, reference voltage amplifier, remote device and relay control circuit

The block diagram below shows the circuit arrangement. The single phase input power is connected to the transformer through the input circuit. Details of each part are described in the next page.

Block diagram

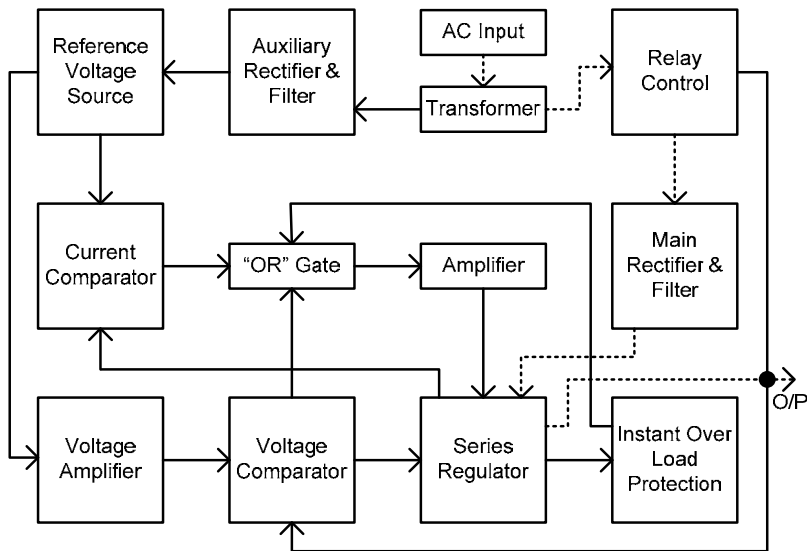

Auxiliary Rectifier	The auxiliary rectifiers D1011~ D1014 provide bias voltage filtered by the capacitors C102 and C103, for the pre-regulators U101 and U102. They provide a regulated voltage for other modules.
Main Rectifier	The main rectifier is a full wave bridge rectifier. It provides the power after the rectifier is filtered by the capacitor C101, and then regulated via a series-wound regulator, which is finally delivered to the output terminal.
Current Limiter	U104 acts as a current limiter. When the current is over predetermined rating, U104 is activated and decreases the current. U208 provides a reference voltage. U206 is an inverter amplifier. U103 is a comparator amplifier which compares the reference voltage to the feedback voltage, and then delivers it to Q102, which then calibrates the output voltage.
Overload	When the unit is overloaded, Q107 activates to control the current magnitude of Q102, to limit the output current. The relay control circuit controls the power dissipation in the series-wound regulated circuit.

Front Panel Overview

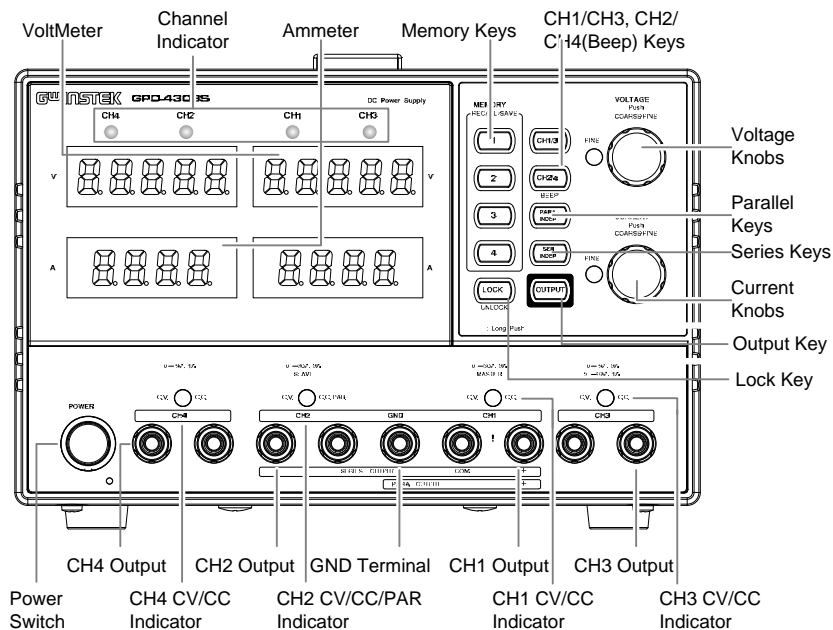

Display

Voltmeter Displays output voltage of each channel.

GPD-4303S: CH1/CH3 and CH2/CH4

GPD-2303S/3303S: CH1 and CH2

5 digits:

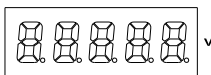

Ammeter Displays output current of each channel.

GPD-4303S: CH1/CH3 and CH2/CH4

GPD-2303S/3303S: CH1 and CH2

4 digits:

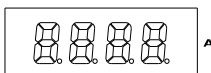

Control Panel

- Memory Keys

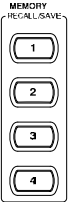

Saves or recalls panel settings. Four settings, 1 ~ 4, are available. For save/recall details, see page41.
- CH1/CH2





GPD-2303S/2303S: Selects the output channel (CH1/CH2) for level adjustment. For level setting details, see page27.

- CH1/3 and CH2/4



GPD-4303S: Selects the output channel (CH1/3 and CH2/4) for level adjustment. For level setting details, see page27.



- Beep Keys





Pressing and holding the CH2 (2303S/3303S) or the CH2/4 key (4303S) enables the beeper sound. For details, see page25.
- Parallel/Series Keys



Activates Tracking Parallel operation or Tracking Series operation, For details, see page33.



- Lock Key



Locks or unlocks the front panel keys (excluding the OUTPUT key). Pressing the LOCK key will also exit remote mode if the machine is in remote mode. For details, see page26.
- Output Key

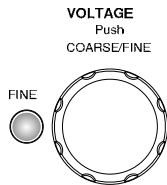

Turns the output on or off.

Voltage Knobs

Adjusts the output voltage level for the selected channel. Pressing the knob switches coarse and fine level setting.

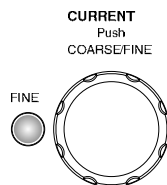
Current Knobs

Adjusts the output current level for the selected channel. Pressing the knob switches coarse and fine level setting.

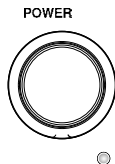
Power Switch

Turns On or Off the main power. For power up sequence, see page 23.

Terminals

Default Terminals

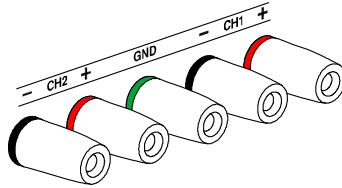

European Terminals

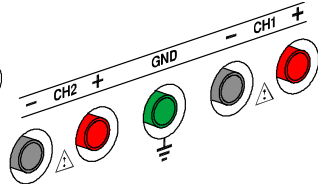

GND Terminal

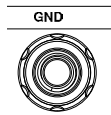

Accepts a grounding wire.

CH1 CV/CC Indicator

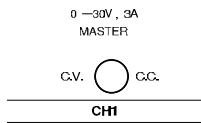

Indicates CH1 Constant Voltage or Constant Current state.

CH1 Output

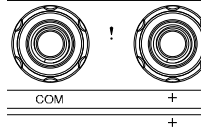

Outputs CH1 voltage and current.

CH2 CV/CC/PAR Indicator

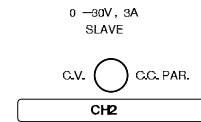

Indicates CH2 Constant Voltage, Constant Current, or Tracking Parallel operation mode.

CH2 Output

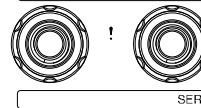

Outputs CH2 voltage and current.

CH3 CV/CC Indicator

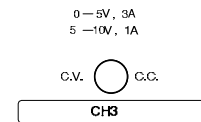

Indicates CH3 Constant Voltage or Constant Current state for the GPD-4303S.

CH3 Output



Outputs CH3 voltage and current.

CH3
Overload
Indicator



Indicates when CH3 (3303S) output current is overloaded.

CH3 Voltage
Selector

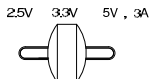

Selects CH3 output voltage for the GPD-3303S: 2.5V, 3.3V, or 5V.

CH4 CV/CC
Indicator

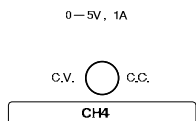

Indicates CH4 constant voltage or constant current for the GPD-4303S.

CH4 Output

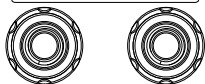

Outputs CH4 voltage and current.

Channel
Indicator



Indicates which channel the 2 LED voltmeters/ammeters represent.

Rear Panel Overview

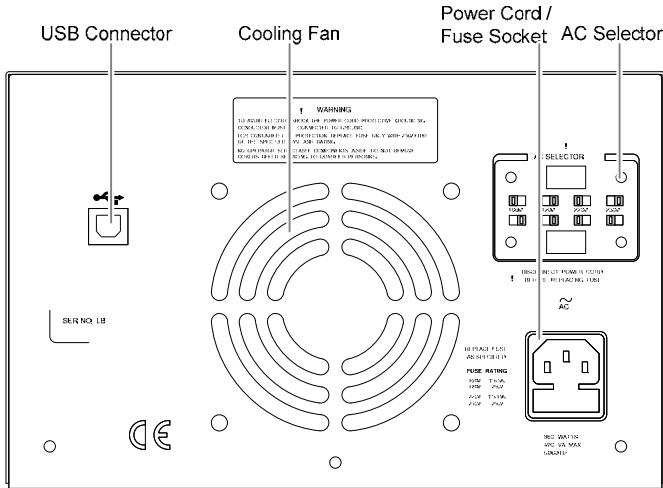

USB Connector



Accepts a USB slave connector for command-based remote control (page43).

Power Cord / Fuse Socket

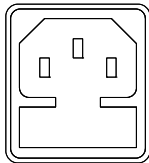

The power cord socket accepts the AC mains: 115V/230V, 50/60Hz. For power up details, see page23.

The fuse holder contains the AC main fuse. For fuse replacement details, see page54.

AC Selector

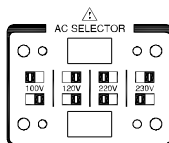

Selects AC voltage: 100V/ 120V/ 220V/ 230V.

CV/CC Crossover Characteristics

Background	The GPD-4303S, GPD-3303S and GPD-3303S automatically switch between constant voltage mode (CV) and constant current mode (CC), according to load condition.
CV mode	When the current level is smaller than the output setting , the GPD-X303S series operates in Constant Voltage mode . The indicator on the front panel turns green (C.V.) The Voltage level is kept at the setting and the Current level fluctuates according to the load condition until it reaches the output current setting.
CC mode	When the current level reaches the output setting , the GPD-X303S series starts operating in Constant Current mode . The indicator on the front panel turns red (C.C.) The Current level is kept at the setting but the Voltage level becomes lower than the setting, in order to suppress the output power level from overload. When the current level becomes lower than the setting, the GPD-X303S series goes back to the Constant Voltage mode.

Diagram

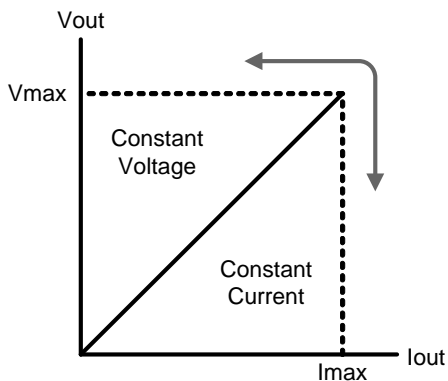

SETUP

This chapter describes how to properly power up and configure the GPD-X303S series before operation.

Power Up

Select AC voltage Before powering up the power supply, select the AC input voltage from the rear panel.

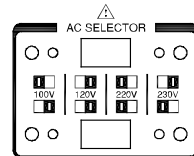

Connect AC power cord Connect the AC power cord to the rear panel socket.

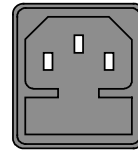

Power On Press the Power switch to turn on the power. The display shows the initialization screen with the model name (3303S shown), followed by the last recalled settings.

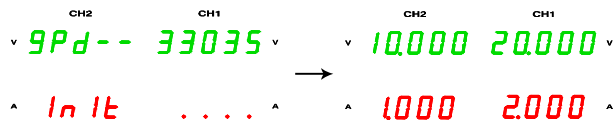

Power Off Press the Power switch again to turn off the power.

Load Cable Connection

GTL-104A

1. Turn the terminal counterclockwise and loosen the screw.
2. Insert the cable terminal.
3. Turn the terminal clockwise and tighten the screw.

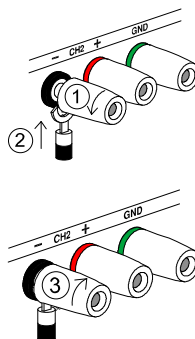

GTL-105A

Insert the plug into the socket.

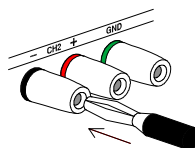

GTL-203A, 204A

Insert the plug into the terminal.

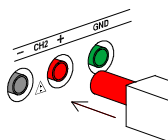

Wire type

When using load cables other than the attached, make sure they have enough current capacity for minimizing cable loss and load line impedance. Voltage drop across a wire should not exceed 0.5V. The following list is the wire current rating at 450A/cm².

Wire size (AWG)	Maximum current (A)
20	2.5
18	4
16	6
14	10
12	16

Output On/Off

Panel operation Pressing the Output key turns on all channel outputs.



The key LED also turns on. Pressing the Output key again turns the output and the key LED off.

Automatic output off Any of the following actions during output on automatically turns it off.

- Change the operation mode between independent / tracking series / tracking parallel
- Recalling other setups from the memory
- Storing the setup into the memory

Beep On/Off

Panel operation By default, the beep sound is enabled. To turn off the beep, press the CH2 or CH2/CH4 key for 2 seconds.

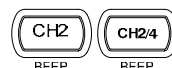

A beep will be heard and the beep setting will be turned off. To enable the beep, press the CH2 or CH2/CH4 key again for 2 seconds.

List of beep The following operations beep when the beep setting is on.

- Power on
- INDEP - SER - PARA mode switching
- Setup save/recall
- Voltage/current knob fine/coarse switching
- Output on/off
- Panel lock/unlock
- CH1/CH2 output level knob switching
- Voltage/current level reaching minimum (zero) level

Switch between channels

Panel operation	Switching between channels only applies to GPD-4303S.	
	Press the CH1/3 key to toggle between CH1 and CH3. The active channel will be shown on the channel indicator.	
	Press the CH2/4 key to toggle between CH2 and CH4. The active channel will be shown on the channel indicator.	

Front Panel Lock

Panel operation	Press the LOCK key to lock the front panel key operation. The key LED turns on. To unlock, press the LOCK key for 2 seconds. The key LED also turns off.	
-----------------	--	--

Note	The OUTPUT key is not affected by the lock operation.	
------	---	--

OPERATION

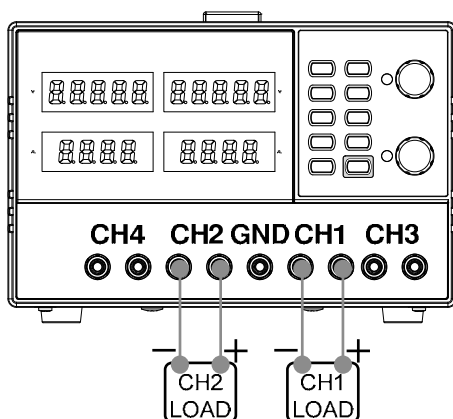

CH1/CH2 Independent Mode

Background / Connection CH1 and CH2 outputs work independent of each other.



Output rating 0 ~ 30V/0~3A for each channel

- Panel operation
1. Make sure the PARA/INDEP and SER/INDEP keys are turned off (the key LEDs are off).

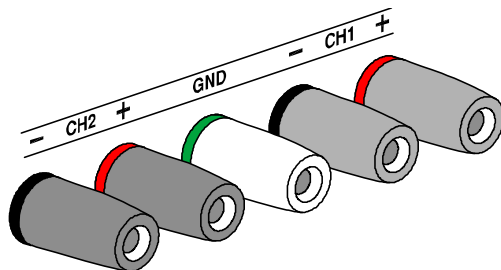

 2. Connect the load to the front panel terminals, CH1 +/-, CH2 +/-.



Note: this diagram shows non-European terminals.

- Set the CH1 output voltage (For CH1) and current. Press the CH1 key (LED turns on) and then use the Voltage and Current knob.

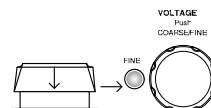
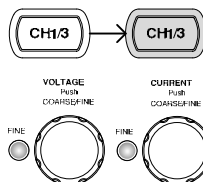
By default, the Voltage and Current knob work in the coarse mode. To activate the fine mode, press the knob to (Fine control) turn the FINE LED on.



- Coarse: 0.1V or 0.1A for each step
- Fine: 1mV or 1mA for each step

- Repeat the above settings for the CH2.

- To turn on the output, press the output key. The key LED turns on and the CH1 / CH2 indicator shows the output mode, CV or CC.

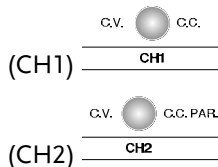
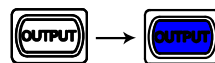

CH3 Independent Mode

Background / Connection For the GDP-3303S the CH3 rating is fixed at 2.5V/3.3V/5V, 3A. CH3 for the 4303S is variable: 0~5V,0~3A / 5.001~10V,0~1A .

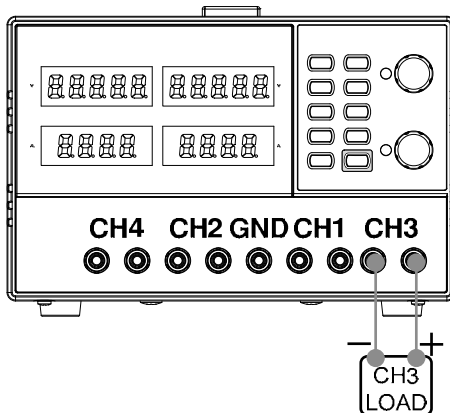

Output rating 3303S : 2.5V/3.3V/5V, 3A (fixed)
4303S : 0~5V,0~3A / 5.001~10V,0~1A

No Tracking Series/Parallel CH3 does not have tracking series/parallel mode. Also, CH3 output is not affected by CH1 and CH2 modes.

Panel operation 1. Connect the load to the front panel CH3 +/- terminal. (the diagram shows non-European terminals)

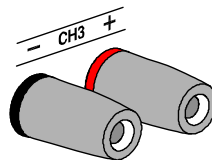

- 3303S: Select the output voltage, 2.5V/3.3V/5V using the CH3 voltage selector key.

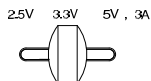

4303S: Press the CH1/3 key to switch to CH3 (The CH3 indicator will light). Use the voltage and current knobs to set the voltage and current.



- To turn on the output, press the output key. The key LED turns on.

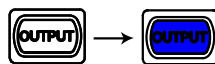

CV → CC

3303S: When the output Current level exceeds 3.2A, the overload indicator turns red and CH3 operation mode switches from Constant Voltage to Constant Current.

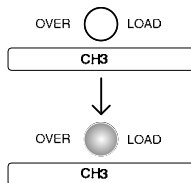

4303S: When the output value exceeds the set value, the C.V./C.C. indicator turns red. This indicates that CH3 has switched from the constant voltage to constant current.

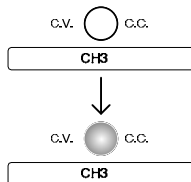

 Note

Note: “overload” on CH3 in this case does not mean an abnormal operation.

CH4 Independent Mode

Background / Connection The GPD-4303S has a rating of 5V/1A max.

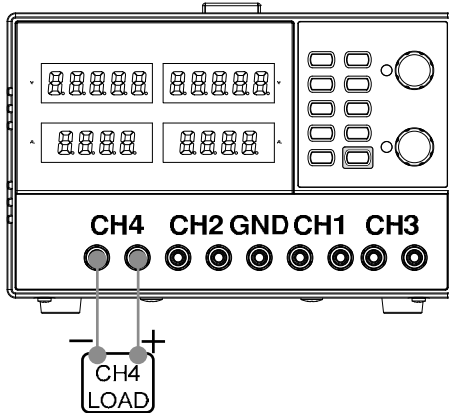

Output rating 5V/1A max

No Tracking CH4 does not have tracking series/parallel mode.
Series/Parallel The CH4 output is not affected by CH1 and CH2 modes.

Panel operation 1. Connect the load to the front panel CH4 +/- terminal. (the diagram shows non-European terminals)

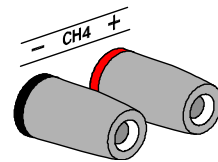

2. Press the CH2/4 key to switch to CH4 (The CH4 indicator will light). Use the voltage and current knobs to set the voltage and current.



3. To turn on the output, press the output key. The key LED turns on.

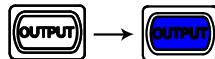

CV → CC

When the output value exceeds the set value, the C.V./C.C. indicator turns red. This indicates that CH3 has switched from constant voltage to constant current.

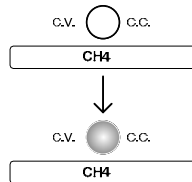

CH1/CH2 Tracking Series Mode

Background Tracking series operation doubles the Voltage capacity of the GPD-X303S series by internally connecting CH1 (Master) and CH2 (Slave) in series and combining the output to a single channel. CH1 (Master) controls the combined Voltage output level.

The following describes two types of configurations depending on the common ground usage.

Tracking series without common terminal

Connection

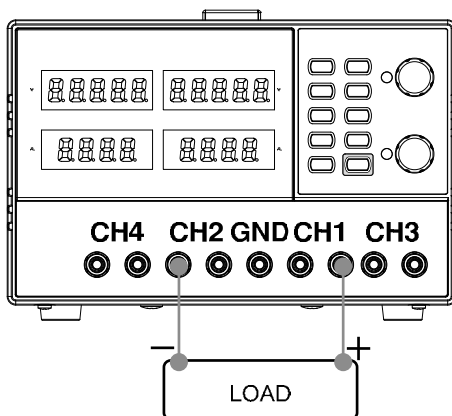

Output rating 0 ~ 60V/0 ~ 3A

1. Press the SER/INDEP key to activate the tracking series mode. The key LED turns on.
2. Connect the load to the front panel terminals, CH1+ & CH2- (Single supply).

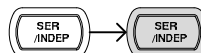

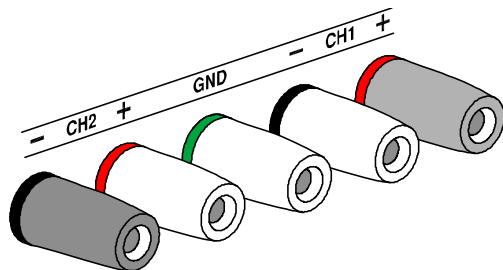

Note: this diagram shows non-European terminals.

- Press the CH2 key (LED turns on) and then use the Current knob to set the CH2 output current to the maximum level (3.0A). By default, the Voltage and Current knob work in the coarse mode. To activate the fine mode, press the knob to turn the FINE LED on.

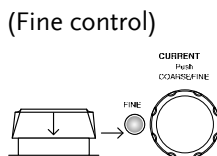
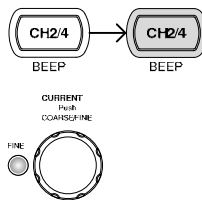

- Coarse: 0.1V or 0.1A for each step
- Fine: 1mV or 1mA for each step

- Press the CH1 key (LED turns on) and then use the Voltage and Current knob to set the output voltage and current level.

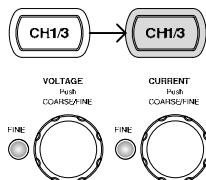

- To turn on the output, press the output key. The key LED turns on.

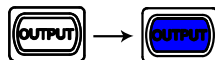

- Refer to the CH1 (Master) meter and indicator for the output setting level and CV/CC status.

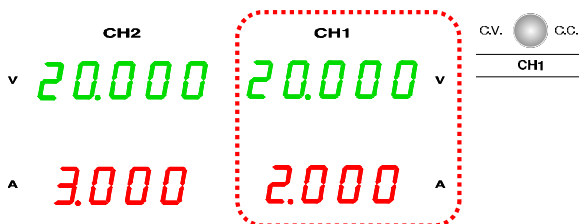

- Voltage level Double the reading on the CH1 Voltage meter. In the above case, the actual output is $20.0 \times 2 = 40.0V$.
- Current level CH1 meter reading shows the output Current. In the above case, 2.000A. (CH2 Current control must be in the Maximum position=3.0A).

Tracking series with common terminal

Connection

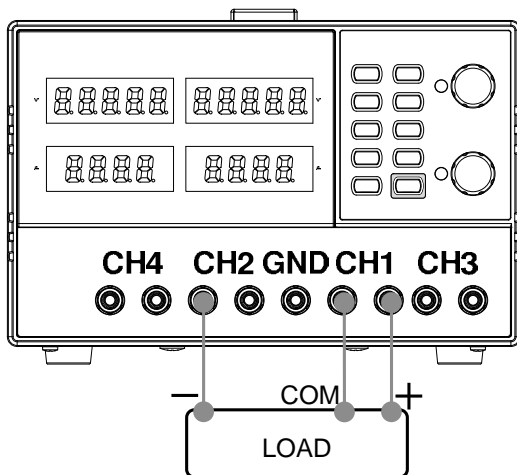

Output rating 0~30V/0~3A for CH1 ~ COM
 0~-30V/0~3A for CH2 ~ COM

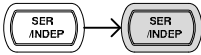
1. Press the SER/INDEP key to activate the tracking series mode. The key LED turns on.
 
2. Connect the load to the front panel terminals, CH1+ & CH2-. Use the CH1 (-) terminal as the common line connection.

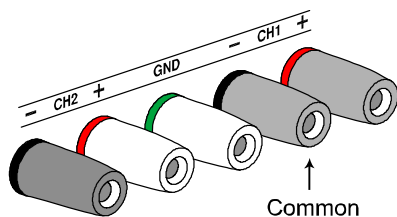

Note: this diagram shows non-European terminals.

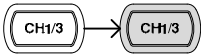
3. Press the CH1/3 key (LED turns on) and use the Voltage knob to set the master & slave output voltage (the same level for both channels).
 

(master & slave)

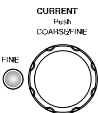

(Fine control)

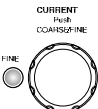

- Coarse: 0.1V or 0.1A for each step
- Fine: 1mV or 1mA for each step

4. Use the Current knob to set the master output current.
 

5. To turn on the output (and LED), press the output key.

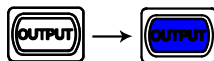

6. For the master (CH1) output level and CV/CC status, refer to the CH1 meter and indicator.

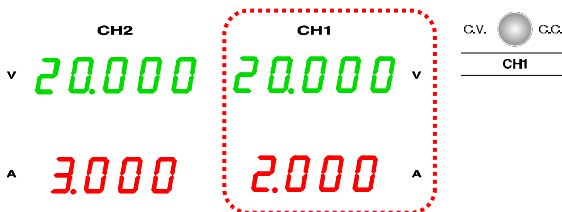

Master (CH1) CH1 meter reading shows the voltage level
 CH1 meter reading shows the output voltage. In the above case, 20.0V.

Master (CH1) CH1 meter reading shows the current level
 CH1 meter reading shows the output current. In the above case, 2.000A.

7. Press the CH2 key (LED turns on) and use the Current knob to set the slave output current.

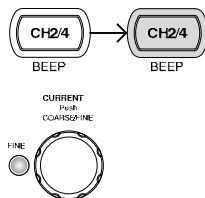

8. For the slave (CH2) output level and CV/CC status, refer to the CH1/CH2 meter and CH2 indicator.

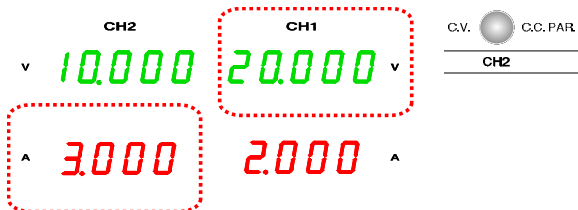

Slave (CH2) voltage level	The CH1 meter reading shows the output voltage. In the above case, 20.0V.
Slave (CH2) current level	The CH2 meter reading shows the output current. In the above case, 3.000A.

CH1/CH2 Tracking Parallel Mode

Background /
Connection

Tracking parallel operation doubles the current capacity of the GPD-X303S series by internally connecting CH1 and CH2 in parallel and combining the output to a single channel. CH1 controls the combined output.

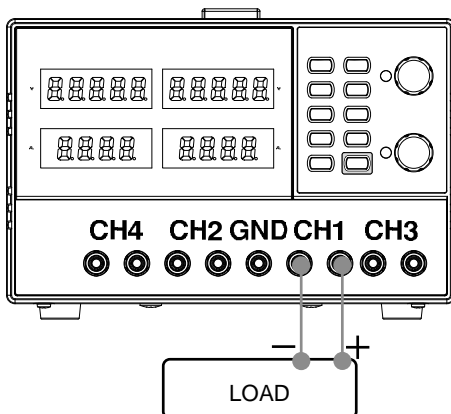

Output rating 0 ~ 30V/0 ~ 6A

1. Press the PARA/INDEP key to activate the tracking parallel mode. The key LED turns on.

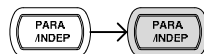

2. Connect the load to the CH1 +/- terminals.

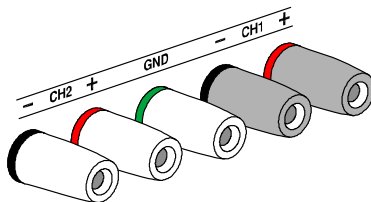

Note: this diagram shows non-European terminals.

3. To turn on the output, press the output key. The key LED turns on.

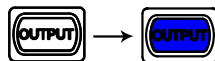

4. The CH2 C.V./C.C. PAR. indicator turns red, indicating tracking parallel (PARA) mode.

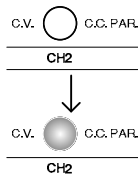

5. Press the CH1 key (LED turns on) and then use the Voltage and Current knob to set the output voltage and current. The CH2 output control is disabled. By default, the Voltage and Current knob work in the coarse mode. To activate the fine mode, press the knob to turn the FINE LED on.

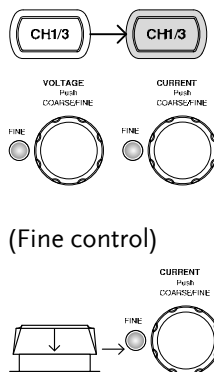

6. For the output level and CV/CC status, refer to the CH1 meter and indicator.

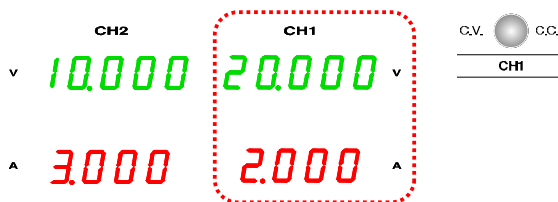

Voltage level The CH1 meter reading shows the output voltage. In the above case, 20.0V.

Current level Double the amount of CH1 current meter reading. In the above case, 2.0A x 2 = 4.0A.

SAVE/RECALL SETUP

Save Setup

Background The front panel settings can be stored into one of the four internal memories.

Contents The following list shows the setup contents.

- Independent / tracking series / tracking parallel mode
- CH1/CH2 knob selection
- Fine/coarse editing mode
- Output voltage/current level

The following settings are always saved as “off”.

- Output on/off
- Front panel lock/unlock
- Buzzer on/off

Panel operation Press one of the 1~4 Memory keys for 2 seconds, for example memory 1. The panel settings are saved in memory 1 and the key LED turns on. When the panel settings are modified, the LED turns off.

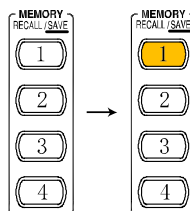

Note When a setting is stored, the output automatically turns off.

Recall Setup

Background The front panel settings can be recalled from one of the four internal memories.

Contents The following list shows the setup contents.

- Independent / tracking series / tracking parallel mode
- CH1/CH2 knob selection
- Fine/coarse editing mode
- Output voltage/current level

The following settings are always recalled as “off”.

- Output on/off
 - Front panel lock/unlock
 - Buzzer on/off
-

Panel operation Press one of the 1~4 Memory keys, for example memory 1. The panel settings saved in memory 1 are recalled. The key LED turns on. When the panel settings are modified, the LED turns off.

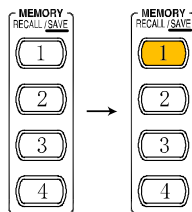

Note When a setting is recalled, the output automatically turns off.

RREMOTE CONTROL

Remote Control Setup

Background	The GPD-X303S is capable of being remotely controlled via a USB connection.	
Interface		USB slave port, rear panel
COM setting	Set up the COM port inside the PC according to the following list. <ul style="list-style-type: none">• Baud rate: 9600/57600 /115200• Parity bit: None• Data bit: 8• Stop bit: 1• Data flow control: None	
Functionality check	Run this query command via the terminal application such as MTTTY (Multi-threaded TTY). <code>*IDN?</code> This should return the identification information: Manufacturer, model name, serial number, firmware version. GW INSTEK, GPD-x303S, SN: xxxxxxxx, Vx.xx	

Remote Connection Step

Entering the remote control mode

1. Connect the USB cable to the slave port.
2. The connection will be automatically established, and the front panel shows a "USB...YES" message.

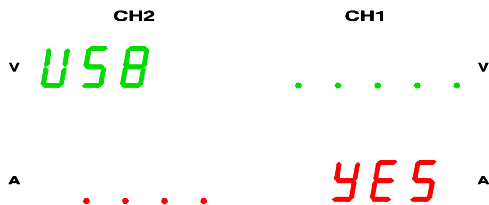

3. The power supply front panel is automatically locked (the Lock key will become activated).

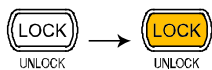

Leaving the remote control mode

1. To exit remote mode either, 1) use the LOCAL command from the terminal connection, or 2) Press the LOCK key on the front panel to return to local mode, or 3) disconnect the USB cable from the rear panel.
2. The display shows "USB...NO" message.

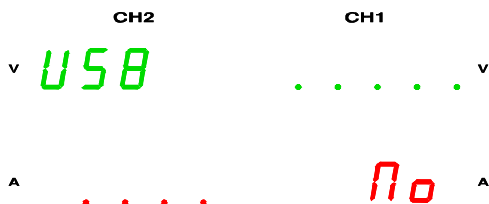

3. The LOCK will no longer be lit when remote mode is off.

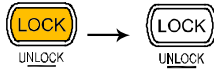

4. The power supply goes back to the local operation mode.

Command Syntax

Command format **ISET<X>:<NR2>NL** 1: command header

 2: output channel
 3: separator
 4: parameter
 5: terminator(line feed)

Output channel	1 (CH1) or 2 (CH2)		
Parameter	Type	Description	Example
	<Boolean>	boolean logic	0 (off), 1 (on)
	<NR1>	integers	0, 1, 2, 3
	<NR2>	decimal numbers	0.1, 3.14, 8.5
Terminator	Each command must end with a terminal character (new line code, ASCII: 0x0A) and each query must end with a carriage return, ASCII: 0x0D.		
Note	Commands are not case-sensitive.		

Error Messages

The following error messages might appear when the GPD-X303S cannot accept the command.

Message contents	Descriptions
a Program mnemonic too long	The command length must be 15 characters or less.
b Invalid character	Invalid characters, such as symbols, are entered. Example: VOUT#
c Missing parameter	The parameter is missing from the command. Example: VSET: (should have a number)
d Data out of range	The entered value exceeds the specification. Example: VSET:33 (should be ≤ 32V)

e	Command not allowed	The entered command is not allowed in the circumstance. Example: trying to set CH2 output while in the tracking mode.
f	Undefined header	The entered command does not exist, or the syntax is wrong.

Command List

- Detailed descriptions of each command start from the next page.
- The “HELP” command shows all the below commands and their meanings, except for the HELP command itself.

ISSET<X>:<NR2>	Sets the output current.
ISSET<X>?	Returns the output current setting.
VSET<X>:<NR2>	Sets the output voltage.
VSET<X>?	Returns the output voltage setting.
IOUT<X>?	Returns the actual output current.
VOUT<X>?	Returns the actual output voltage.
TRACK<NR1>	Selects the operation mode.
BEEP<BOOLEAN>	Turn on or off the beep.
OUT<BOOLEAN>	Turn on or off the output.
STATUS?	Returns the GPD-X303S status.
*IDN?	Returns the GPD-X303S identification.
RCL<NR1>	Recalls a panel setting.
SAV<NR1>	Saves the panel setting.
HELP?	Shows the command list.
ERR?	Returns the instrument error messages.
BAUD<NR1>	Sets the baud rate.
LOCAL	Returns the instrument to local mode.

Command Details

ISET<X>:<NR2>

Description	Sets the output current for the selected channel.	
X	1= CH1, 2= CH2, (4303S: 3 = CH3, 4= CH4)	
<NR2>	Decimal number, range 0~3.200A	
Response time	Minimum 10ms	
Example	ISET1:2.234	Sets the CH1 output current to 2.234A.

ISET<X>?

Description	Returns the output current setting.	
X	1= CH1, 2= CH2, (4303S: 3 = CH3, 4= CH4)	
Response time	Minimum 10ms	
Example	ISET1?	Returns the CH1 output current setting.

VSET<X>:<NR2>

Description	Sets the output voltage.	
X	1: CH1, 2: CH2, (4303S: 3: CH3, 4: CH4)	
<NR2>	Decimal number, range 0~32.000V	
Response time	Minimum 10ms	
Example	VSET1:20.345	Sets the CH1 voltage to 20.345V

VSET<X>?

Description	Returns the output voltage setting.	
X	1: CH1, 2: CH2, (4303S: 3: CH3, 4: CH4)	
Response time	Minimum 10ms	
Example	VSET1?	Returns the CH1 voltage setting

IOUT<X>?

Description	Returns the actual output current.	
X	1: CH1, 2: CH2, (4303S: 3: CH3, 4: CH4)	
Response time	Minimum 10ms	
Example	IOUT1?	Returns the CH1 output current

VOUT<X>?

Description	Returns the actual output voltage.	
X	1: CH1, 2: CH2, (4303S: 3: CH3, 4: CH4)	
Response time	Minimum 10ms	
Example	VOUT1?	Returns the CH1 output voltage

TRACK<NR1>

Description	Selects the operation mode: independent, tracking series, or tracking parallel.	
NR1	0: Independent, 1: Series, 2: Parallel	
Response time	Minimum 10ms	
Example	TRACK0	Selects the independent mode

BEEP<Boolean>

Description	Turns the beep on or off.	
<Boolean>	0:off, 1:on	
Response time	Minimum 10ms	
Example	BEEP1	Turns on the beep

OUT<Boolean>

Description	Turns on or off the output.	
<Boolean>	0: off, 1: on	
Response time	Minimum 10ms	
Example	OUT1	Turns on the output

STATUS?

Description	Returns the GPD-X3303S.	
Response time	Minimum 10ms	

Return parameter 8 bits in the following format

Bit	Item	Description
0	CH1	0=CC mode, 1=CV mode
1	CH2	0=CC mode, 1=CV mode
2, 3	Tracking	01=Independent, 11=Tracking series, 10=Tracking parallel
4	Beep	0=Off, 1=On
5	Output	0=Off, 1=On
6, 7	Baud	00=115200bps, 01=57600bps, 10=9600bps

*IDN?

Description	Returns the instrument identification.	
Response time	Minimum 10ms	

Return parameter GW INSTEK,GPD-X3303,SN: xxxxxxxx, Vx.xx
(Manufacturer, model name, serial number,
firmware version)

RCL<NR1>

Description	Recalls a panel setting.	
<NR1>	1 - 4: Memory 1 to 4	
Response time	Minimum 10ms	
Example	RCL1	Recalls the panel setting stored in memory 1

SAV<NR1>

Description	Stores the panel setting.	
<NR1>	1 - 4: Memory 1 to 4	
Response time	Minimum 10ms	
Example	SAV1	Stores the panel setting in memory 1

BAUD<NR1>

Description	Sets the baud rate to 9600bps/57600bps /115200bps.	
<NR1>	0: 115200bps, 1: 57600bps, 2: 9600bps	
Response time	Minimum 10ms	
Example	BAUD0	Sets the baud rate to 115200bps.

LOCAL

Description	Exits remote mode and sets the instrument to local mode.
-------------	--

Response time Minimum 10ms

ERR?

Description Checks the error status of the instrument and returns the last error message.

Response time Minimum 10ms

Contents See page 46 for the list of error messages.

HELP?

Description Shows the command list.

Response time Minimum 50ms

Return parameters ISET<x>:<NR2> Sets the value of current.
 VSET<x>:<NR2> Sets the value of voltage.
 ISET<x> ? Return the value of current.
 VSET<x> ? Return the value of voltage.
 IOUT<x> ? Returns actual output current ,
 VOUT<x> ? Returns actual output voltage.
 TRACK<NR1> Sets the output of the power supply working on independent or tracking mode.
 BAUD< NR1 >Set the value of baud rate.
 RCL<NR1> Recall the setting data from the memory which previous saved.
 SAV<NR1> Saves the setting data to memory.
 BEEP<Boolean> Sets the BEEP state on or off.
 OUT<Boolean> Sets the output state on or off.
 LOCAL Return to local mode
 *IDN ? Returns instrument identification.
 ERR ? Returns instrument error messages.
 STATUS ? Returns the power supply state.



Note

All response time estimates are based on a baud rate of 115200bps. Expect longer response times with a baud rate of 57600bps or 9600bps.

F AQ

Q1. I pressed the panel lock key but the output still turns on/off.

A1. For safety reasons the output key is not affected by the panel key lock feature.

Q2. The CH3 overload indicator turned on – is this an error?

A2. No, it simply means that the CH3 output current reached the maximum 3.0A and the operation mode turned from CV (constant voltage) to CC (constant current). You can continue using the power supply, although reducing the output load is recommended.

Q3. The specifications do not match the real accuracies.

A3. Make sure that the power supply is powered on for at least 30 minutes, within +20°C – +30°C.

Q4. The internal memory is not recording the panel setting correctly – the output should be on.

A4. The output is always stored or recalled as “off” to ensure safety.

For more information, contact your local dealer or GWInstek at www.gwinstek.com.tw / marketing@goodwill.com.tw.

APPENDIX

Fuse Replacement

Steps

1. Take off the power cord and remove the fuse socket using a minus driver.

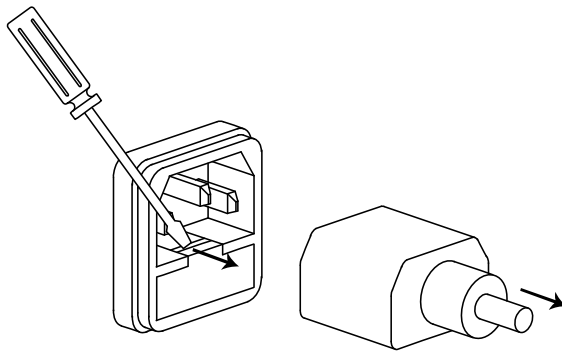

2. Replace the fuse in the holder.

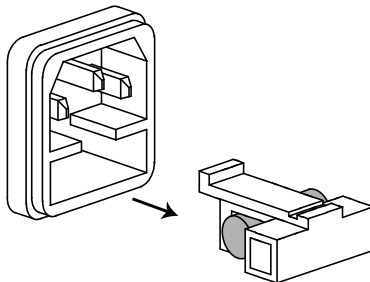

Rating

- 100V/120V:T6.3A/250V
- 220V/230V:T3.15A/250V

Specifications

The specifications apply when the GPD-X303S series are powered on for at least 30 minutes under +20°C – +30°C.

Output Ratings	CH1/CH2 Independent	0 ~ 30V / 0 ~ 3A
	CH1/CH2 Series	0 ~ 60V / 0 ~ 3A
	CH1/CH2 Parallel	0 ~ 30V / 0 ~ 6A
	CH3	2.5V/3.3V/5.0V, 0 ~ 3A(3303S) 0~5V,0~3A / 5.001~10V,0~1A(4303S)
Voltage Regulation	CH4	0~5V,0~1A
	Line	≤ 0.01% + 3mV
	Load	≤ 0.01% + 3mV (rating current ≤ 3A)
		≤ 0.02% + 5mV (rating current > 3A)
	Ripple & Noise	≤ 1mVrms (5Hz ~ 1MHz)
	Recovery Time	≤ 100μs (50% load change, minimum load 0.5A)
Current Regulation	Temperature Coefficient	≤ 300ppm/°C
	Line	≤ 0.2% + 3mA
	Load	≤ 0.2% + 3mA
Tracking Operation	Ripple & Noise	≤ 3mArms
	Tracking Error	≤ 0.1% + 10mV of Master (0~30V) (No Load, with load add load regulation ≤ 100mV))
	Parallel Regulation	Line: ≤ 0.01% + 3mV
		Load: ≤ 0.01% + 3mV (rating current ≤ 3A) Load: ≤ 0.02% + 5mV (rating current > 3A)
Meter Resolution	Series Regulation	Line: ≤ 0.01% + 5mV Load: ≤ 100mV
	Voltage and current	Voltage: 1mV Current: 1mA
Resolution	Ammeter	3.2A full scale, 4 digits 0.4" LED display

	Voltmeter	32V full scale, 5 digits 0.4" LED display
Program		Voltage: $\pm (0.03\% \text{ of reading} + 10\text{mV})$
Accuracy		Current: $\pm (0.3\% \text{ of reading} + 10\text{mA})$
Read back		Voltage: $\pm (0.03\% \text{ of reading} + 10\text{mV})$
Accuracy		Current: $\pm (0.3\% \text{ of reading} + 10\text{mA})$
CH3 of 3303S	Voltage	2.5V/3.3V/5.0V, $\pm 5\%$
	Current	3A
	Line	$\leq 3\text{mV}$
	Load	$\leq 5\text{mV}$
	Ripple & Noise	$\leq 1\text{mVrms}$ (5Hz ~ 1MHz)
Insulation	Chassis and Terminal	20M Ω or above (DC 500V)
	Chassis and AC cord	30M Ω or above (DC 500V)
Operation Environment	Indoor use, Altitude: $\leq 2000\text{m}$ Ambient temperature: 0 ~ 40°C Relative humidity: $\leq 80\%$ Installation category: II, Pollution degree: 2	
Storage Environment	Ambient temperature: -10 ~ 70°C Relative humidity: $\leq 70\%$	
Power Source	AC 100V/120V/220V/230V $\pm 10\%$, 50/60Hz	
Accessories	User manual	x1
	Test lead	GTL-104A x 2, GTL-105A x 1 (Europe) Test lead GTL-203A x 1, GTL-204A x 2
Dimensions	210 (W) x 130 (H) x 265 (D) mm	
Weight	Approx. 7kg	

Options

USB cable	GTL-246	USB 2.0, A-B type
-----------	---------	-------------------

Declaration of Conformity

We

GOOD WILL INSTRUMENT CO., LTD.

(1) No.7-1, Zhongxing Rd., Tucheng Dist., xinbei City 236, Taiwan

(2) No. 69, Lu San Road, Suzhou City (Xin Qu), Jiangsu Sheng, China

declare, that the below mentioned product

Type of Product: Power Supply

Model Number: GPD-2303S/ GPD-3303S / GPD-4303S

are herewith confirmed to comply with the requirements set out in the Council Directive on the Approximation of the Law of Member States relating to Electromagnetic Compatibility (2004/108/EC) and Low Voltage Directive (2006/95/EC).

For the evaluation regarding the Electromagnetic Compatibility and Low Voltage Directive, the following standards were applied:

© **EMC**

EN 61326-1: 2006 Electrical equipment for measurement, control and laboratory use -- EMC requirements		
Conducted Emission	ClassB	Electrostatic Discharge
Radiated Emission		EN 61000-4-2: 2008
EN 55011: 2009 + A1: 2010		Radiated Immunity
		EN 61000-4-3: 2006+A2:2010
Current Harmonics		Electrical Fast Transients
EN 61000-3-2: 2006+A2:2009		EN 61000-4-4: 2004+A1:2010
Voltage Fluctuations		Surge Immunity
EN 61000-3-3: 2008		EN 61000-4-5: 2005
-----		Conducted Susceptibility
		EN 61000-4-6:2008
-----		Power Frequency Magnetic Field
		EN 61000-4-8: 2009
-----		Voltage Dip/ Interruption
		EN 61000-4-11: 2004

© **Safety**

Low Voltage Equipment Directive 2006/95/EC
Safety Requirements
IEC/EN 61010-1: 2001(Second Edition)

INDEX

Automatic out off	25	Operation.....	7
Banana plug	24	Specification	55
Baud rate		Storage.....	8
Remote control.....	51	Error messages, remote	
Beep setting		control	46, 52
Contents.....	25	Front panel	
Manual.....	25	Lock (manual)	26
Remote control.....	50	Overview	16
Caution symbol	5	Fuse	
CC/CV.....	30	Rating	55
CC/CV indicator	32	Replacement.....	54
Cleaning the instrument.....	7	Safety instruction.....	7
COM setting, remote control		GPD series	
.....	43	Block diagram	14
Command list	47	Dynamic load	12
Recalling the list	52	List of features.....	13
Common terminal, tracking		Operation theory	14
series.....	33	Technology overview.....	10
Cooling fan.....	21	Ground symbol	5
safety instruction.....	6	Identification information ..	50
CV/CC		Load connection.....	24
CH1/CH2 indicator	28	Local	
CH3 indicator.....	30	Remote control	51
CH4 indicator.....	32	Operation mode	
Operation theory	11, 22	Independent	27
Disposal instructions	8	Specifications.....	55
EN61010		Tracking parallel.....	39
Declaration of conformity	57	Tracking series	33
Measurement category	6	Output current setting	
Pollution degree	8	Manual	28
EN61326-1	57	Remote control.....	48
Environment		Output on/off	

FAQ	53	Command syntax.....	46
manual	25	Connection test.....	43
Remote	50	Error messages	46
Output voltage setting		Interface.....	43
Manual	28	Save settings	
Remote control.....	48	Manual	41
Over load indicator	30	Remote.....	51
Power supply		Service operation	
Safety instruction.....	6	About disassembly	6
Setup	23	Contact	53
Socket overview.....	21	Status, instrument.....	50
Specification	55	Switch channels.....	26
Protective ground symbol.....	5	Tracking mode	
Rear panel overview	21	Operation theory.....	11
Recall settings		UK power cord.....	9
Manual	42	USB interface	43
Remote	51	Warning symbol.....	5
Remote control		Wire, load.....	24