

Digital Storage Oscilloscope

GDS-2000E Series

USER MANUAL

GW INSTEK PART NO. 82DS-2KE00E01



ISO-9001 CERTIFIED MANUFACTURER

GW INSTEK

This manual contains proprietary information, which is protected by copyright. All rights are reserved. No part of this manual may be photocopied, reproduced or translated to another language without prior written consent of Good Will company.

The information in this manual was correct at the time of printing. However, Good Will continues to improve products and reserves the rights to change specification, equipment, and maintenance procedures at any time without notice.

Good Will Instrument Co., Ltd.
No. 7-1, Jhongsing Rd., Tucheng Dist., New Taipei City 236, Taiwan

Table of Contents

SAFETY INSTRUCTIONS	5
GETTING STARTED	10
GDS-2000E Series Overview	11
Appearance	15
Set Up	27
Built-in Help	36
MEASUREMENT	37
Basic Measurement	38
Automatic Measurement	45
Cursor Measurement	59
Math Operation	67
CONFIGURATION	77
Acquisition	80
Segmented Memory Acquisition Overview	85
Display	98
Horizontal View	104
Vertical View (Channel)	113
Bus Key Configuration	121
Trigger	144
Search	176
System Settings and Miscellaneous Settings	185
APPS	190
Applications	191
SAVE/RECALL	213

File Format/Utility	214
Create/Edit Labels.....	219
Save	222
Recall	230
Reference Waveforms	236
FILE UTILITIES.....	238
HARDCOPY KEY.....	245
REMOTE CONTROL CONFIG	249
Interface Configuration	250
MAINTENANCE	261
FAQ	267
APPENDIX	270
GDS-2000E Specifications.....	270
Probe Specifications	274
GDS-2000E Dimensions	276
Declaration of Conformity	277
INDEX.....	278

S SAFETY INSTRUCTIONS

This chapter contains important safety instructions that you must follow during operation and storage. Read the following before any operation to insure your safety and to keep the instrument in the best possible condition.

Safety Symbols

These safety symbols may appear in this manual or on the GDS-2000E.



WARNING

Warning: Identifies conditions or practices that could result in injury or loss of life.



CAUTION

Caution: Identifies conditions or practices that could result in damage to the GDS-2000E or to other properties.



DANGER High Voltage



Attention Refer to the Manual



Protective Conductor Terminal



Earth (ground) Terminal



Do not dispose electronic equipment as unsorted municipal waste. Please use a separate collection facility or contact the supplier from which this instrument was purchased.

Safety Guidelines

General Guideline



CAUTION

- Make sure the BNC input voltage does not exceed 300Vpk.
- Never connect a hazardous live voltage to the ground side of the BNC connectors. It might lead to fire and electric shock.
- Do not place any heavy object on the GDS-2000E.
- Avoid severe impact or rough handling that leads to damaging the GDS-2000E.
- Do not discharge static electricity to the GDS-2000E.
- Use only mating connectors, not bare wires, for the terminals.
- Do not block the cooling fan opening.
- Do not perform measurement at a power source or building installation site (Note below).
- Do not disassemble the GDS-2000E unless you are qualified.

(Measurement categories) EN 61010-1:2010 specifies the measurement categories and their requirements as follows. The GDS-2000E falls under category I.

- Measurement category IV is for measurement performed at the source of low-voltage installation.
- Measurement category III is for measurement performed in the building installation.
- Measurement category II is for measurement performed on the circuits directly connected to the low voltage installation.
- Measurement category I is for measurements performed on circuits not directly connected to Mains.

Power Supply	<ul style="list-style-type: none">• AC Input voltage: 100 - 240V AC, 50 - 60Hz, auto selection. Power consumption: 30 Watts.• Connect the protective grounding conductor of the AC power cord to an earth ground, to avoid electrical shock.
--------------	---

Cleaning the GDS-2000E	<ul style="list-style-type: none">• Disconnect the power cord before cleaning.• Use a soft cloth dampened in a solution of mild detergent and water. Do not spray any liquid.• Do not use chemicals containing harsh materials such as benzene, toluene, xylene, and acetone.
------------------------	---

Operation Environment	<ul style="list-style-type: none">• Location: Indoor, no direct sunlight, dust free, almost non-conductive pollution (Note below)• Relative Humidity: $\leq 80\%$, 40°C or below; $\leq 45\%$, $41^{\circ}\text{C} \sim 50^{\circ}\text{C}$• Altitude: $< 2000\text{m}$• Temperature: 0°C to 50°C <p>(Pollution Degree) EN 61010-1:2001 specifies the pollution degrees and their requirements as follows. The GDS-2000E falls under degree 2.</p> <p>Pollution refers to “addition of foreign matter, solid, liquid, or gaseous (ionized gases), that may produce a reduction of dielectric strength or surface resistivity”.</p> <ul style="list-style-type: none">• Pollution degree 1: No pollution or only dry, non-conductive pollution occurs. The pollution has no influence.• Pollution degree 2: Normally only non-conductive pollution occurs. Occasionally, however, a temporary conductivity caused by condensation must be expected.• Pollution degree 3: Conductive pollution occurs, or dry, non-conductive pollution occurs which becomes conductive due to condensation which is expected. In such conditions, equipment is normally protected against exposure to direct sunlight, precipitation, and full wind pressure, but neither temperature nor humidity is controlled.
-----------------------	---

Storage environment	<ul style="list-style-type: none">• Location: Indoor• Temperature: -10°C to 60°C $40^{\circ}\text{C} / 93\% \text{ RH}$ $41^{\circ}\text{C} \sim 60^{\circ}\text{C} / 65\% \text{ RH}$
---------------------	---

Disposal

Do not dispose this instrument as unsorted municipal waste. Please use a separate collection facility or contact the supplier from which this instrument was purchased. Please make sure discarded electrical waste is properly recycled to reduce environmental impact.

Power cord for the United Kingdom

When using the oscilloscope in the United Kingdom, make sure the power cord meets the following safety instructions.

NOTE: This lead/appliance must only be wired by competent persons

 **WARNING: THIS APPLIANCE MUST BE EARTHED**

IMPORTANT: The wires in this lead are coloured in accordance with the following code:

Green/ Yellow:	Earth
Blue:	Neutral
Brown:	Live (Phase)



As the colours of the wires in main leads may not correspond with the coloured marking identified in your plug/appliance, proceed as follows:

The wire which is coloured Green & Yellow must be connected to the Earth terminal marked with either the letter E, the earth symbol  or coloured Green/Green & Yellow.

The wire which is coloured Blue must be connected to the terminal which is marked with the letter N or coloured Blue or Black.

The wire which is coloured Brown must be connected to the terminal marked with the letter L or P or coloured Brown or Red.

If in doubt, consult the instructions provided with the equipment or contact the supplier.

This cable/appliance should be protected by a suitably rated and approved HBC mains fuse: refer to the rating information on the equipment and/or user instructions for details. As a guide, a cable of 0.75mm² should be protected by a 3A or 5A fuse. Larger conductors would normally require 13A types, depending on the connection method used.

Any exposed wiring from a cable, plug or connection that is engaged in a live socket is extremely hazardous. If a cable or plug is deemed hazardous, turn off the mains power and remove the cable, any fuses and fuse assemblies. All hazardous wiring must be immediately destroyed and replaced in accordance to the above standard.

GETTING STARTED

This chapter describes the GDS-2000E in a nutshell, including its main features and front / rear panel introduction. After going through the overview, follow the Set Up section to properly set up the oscilloscope for first time use. The Set Up section also includes a starter on how to use this manual effectively.



GDS-2000E Series Overview	11
Series lineup	11
Main Features	12
Accessories.....	13
Appearance	15
GDS-2074E/2104E/2204E Front Panel	15
GDS-2072E/2102E/2202E Front Panel	16
Rear Panel	23
Display.....	25
Set Up.....	27
Tilt Stand.....	27
Power Up	28
First Time Use.....	29
How to Use This Manual.....	31

GDS-2000E Series Overview

Series lineup

The GDS-2000E series consists of 6 models, divided into 2-channel and 4-channel versions.

Model name	Frequency bandwidth	Input channels	Max. Real-time Sampling Rate
GDS-2072E	70MHz	2	1GSa/s
GDS-2102E	100MHz	2	1GSa/s
GDS-2202E	200MHz	2	1GSa/s
GDS-2074E	70MHz	4	1GSa/s
GDS-2104E	100MHz	4	1GSa/s
GDS-2204E	200MHz	4	1GSa/s

Main Features

- Features
- 8 inch, 800 x 480, WVGA TFT display.
 - Available from 70MHz to 200MHz.
 - Real-time sampling rate of 1GSa/s (2 channel models), 1GSa/s max. (4 channel models).
 - Deep memory: 10M points record length.
 - Waveform capture rate of 120,000 waveforms per second.
 - Vertical sensitivity: 1mV/div~10V/div.
 - Segmented Memory: Optimizes the acquisition memory to selectively capture only the important signal details. Up to 29000 successive waveform segments can be captured with a time-tag resolution of 4ns.
 - Waveform Search: Allows the scope to search for a number of different signal events.
 - On-screen Help.
 - 32 MB internal flash disk.
-

- Interface
- USB host port: front panel, for storage devices.
 - USB device port: rear panel, for remote control or printing.
 - Probe calibration output with selectable output frequency (1kHz ~ 200kHz).
 - Ethernet port as standard.
 - Calibration output.

Accessories

Standard Accessories	Part number	Description
	N/A	Quick Start Guide
	N/A region dependent	Power cord
	GTP-070A-4, for GDS-2072E/GDS-2074E	Passive probe; 70 MHz
	GTP-150A-4, for GDS-2102E/GDS-2104E	Passive probe; 150 MHz
	GTP-300A-4, for GDS-2202E/GDS-2204E	Passive probe; 300 MHz
Standard Apps	Name	Description
	Go-NoGo	Go-NoGo testing app.
	DataLog	Waveform or image data logging app.
	DVM	Digital Volt Meter app.
	Digital Filter	High or low pass digital filter for analog inputs.
	Remote Disk	Allows the scope to mount a network share drive.
	Demo Mode	Demonstration mode that is used with the GDB-03 demo board.
Optional Accessories	Part number	Description
	GTC-001	Instrument cart, 470(W)x430(D)mm (U.S. type input socket)
	GTC-002	Instrument cart, 330(W)x430(D)mm (U.S. type input socket)
	GDB-03	Demo board
	GTL-110	test lead, BNC to BNC heads

GTL-242	USB cable, USB2.0A-B type cable 4P
GTP-070A-4	Passive probe; 70 MHz
GTP-150A-4	Passive probe; 150 MHz
GTP-300A-4	Passive probe; 300 MHz

Drivers

USB driver

LabVIEW driver

Appearance

GDS-2074E/2104E/2204E Front Panel

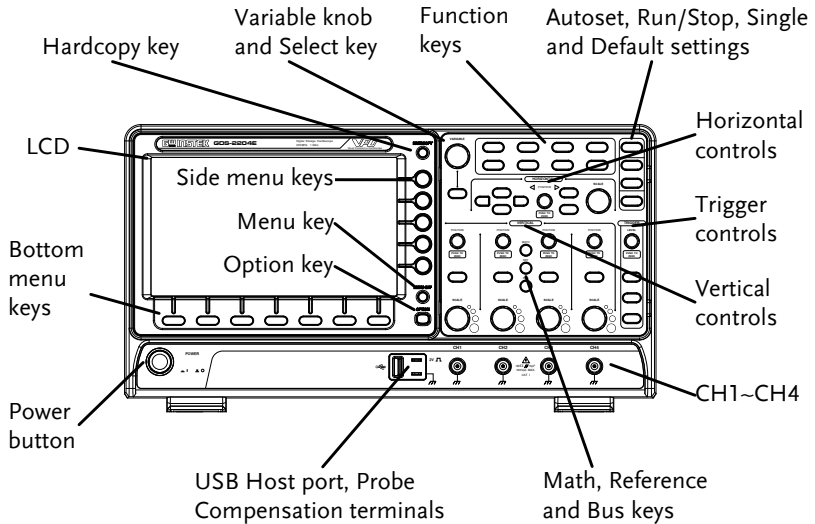

GDS-2072E/2102E/2202E Front Panel

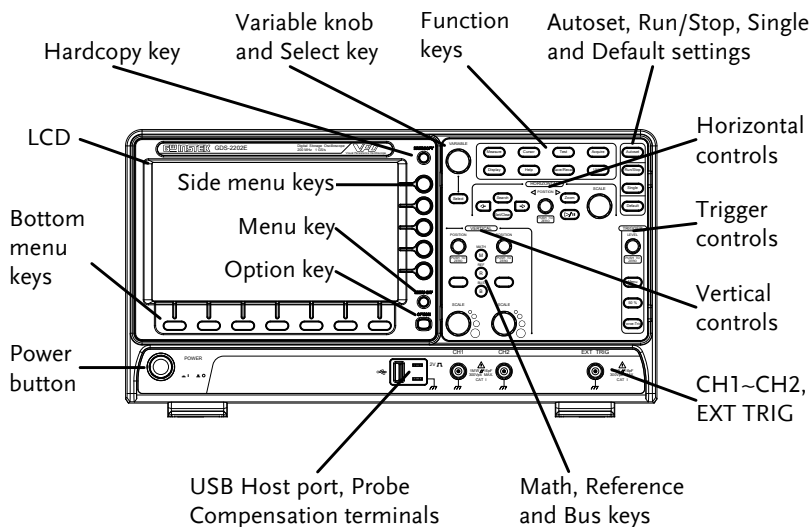

LCD Display 8" WVGA TFT color LCD. 800 x 480 resolution, wide angle view display.

Menu Off Key **MENU OFF** Use the Menu Off key to hide the onscreen menu system.



Option Key **OPTION** The Option key is used to access future installed options.



Menu Keys

The side menu and bottom menu keys are used to make selections from the soft-menus on the LCD user interface.

To choose menu items, use the 7 Bottom menu keys located on the bottom of the display panel.

To select a variable or option from a menu, use the side menu keys on the side of the panel. See page 31 for details.

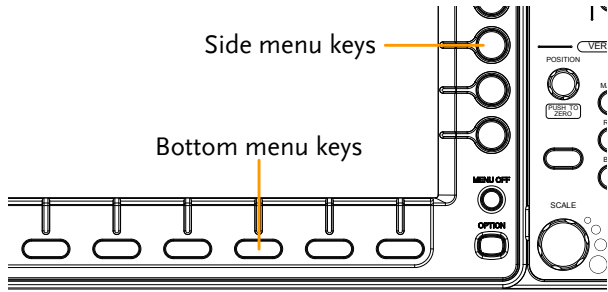

Hardcopy Key

HARDCOPY



The Hardcopy key is a quick-save or quick-print key, depending on its configuration. For more information see pages 247(save) or 246(print).

Variable Knob and Select Key

VARIABLE

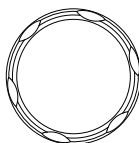





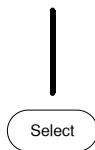



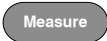
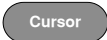



The Variable knob is used to increase/decrease values or to move between parameters.





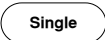

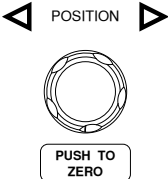
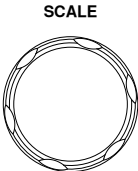



The Select key is used to make selections.



Function Keys The Function keys are used to enter and configure different functions on the GDS-2000E.

Measure		Configures and runs automatic measurements.
Cursor		Configures and runs cursor measurements.
APP		Configures and runs GW Instek applications.
Acquire		Configures the acquisition mode, including Segmented Memory acquisition.
Display		Configures the display settings.
Help		Shows the Help menu.
Save/Recall		Used to save and recall waveforms, images, panel settings.
Utility		Configures the Hardcopy key, display time, language, probe compensation and calibration. It also accesses the file utilities menu.
Autoset		Press the Autoset key to automatically set the trigger, horizontal scale and vertical scale.

- | | | |
|--------------|---|---|
| Run/Stop Key |  | Press to Freeze (Stop) or continue (Run) signal acquisition (page 41). The run stop key is also used to run or stop Segmented Memory acquisition (page 89). |
|--------------|---|---|
- | | | |
|--------|---|--|
| Single |  | Sets the acquisition mode to single triggering mode. |
|--------|---|--|
- | | | |
|---------------|---|--|
| Default Setup |  | Resets the oscilloscope to the default settings. |
|---------------|---|--|
- | | | |
|---------------------|---|--|
| Horizontal Controls | The horizontal controls are used to change the position of the cursor, set the time base settings, zoom into the waveforms and search for events. | |
|---------------------|---|--|
- | | | |
|---------------------|---|--|
| Horizontal Position |  | The Position knob is used to position the waveforms horizontally on the display screen. Pressing the knob will reset the position to zero. |
|---------------------|---|--|
- | | | |
|-------|--|---|
| SCALE |  | The Scale knob is used to change the horizontal scale (TIME/DIV). |
|-------|--|---|
- | | | |
|------|---|--|
| Zoom |  | Press Zoom in combination with the horizontal Position knob. |
|------|---|--|
- | | | |
|------------|---|---|
| Play/Pause |  | The Play/Pause key allows you to view each search event in succession - to effectively "play" through each search event. It is also used to play through a waveform in zoom mode. |
|------------|---|---|

Search		The Search key accesses the search function menu to set the search type, source and threshold.
Search Arrows		Use the arrow keys to navigate the search events.
Set/Clear		Use the Set/Clear key to set or clear points of interest when using the search function.
Trigger Controls	The trigger controls are used to control the trigger level and options.	
Level Knob	<p style="margin: 0;">LEVEL</p> 	Used to set the trigger level. Pressing the knob will reset the level to zero.
Trigger Menu Key		Used to bring up the trigger menu.
50% Key		Sets the trigger level to the half way point (50%).
Force - Trig		Press to force an immediate trigger of the waveform.
Vertical POSITION	<p style="margin: 0;">POSITION</p>  	Sets the vertical position of the waveform. Push the knob to reset the vertical position to zero.
Channel Menu Key		Press the CH1~4 key to set and configure the channel.

(Vertical)SCALE
Knob

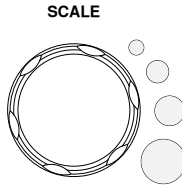

Sets the vertical scale of the channel (TIME/DIV).

External Trigger
Input

EXT TRIG



Accepts external trigger signals (page 144). Only on 2 channel models.

Input impedance: $1M\Omega$
Voltage input: $\pm 15V$ (peak), EXT
trigger capacitance: $16pF$.

Math Key

MATH



Use the Math key to set and
configure math functions.

Reference Key

REF



Press the Reference key to set or
remove reference waveforms.

BUS Key

BUS



The Bus key is used for parallel
and serial bus (UART, I²C, SPI,
CAN, LIN) configuration.

Channel Inputs

CH1

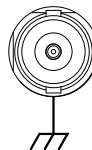

Accepts input signals.
Input impedance: $1M\Omega$.
Capacitance: $16pF$
CAT I

USB Host Port

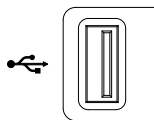

TypeA, 1.1/2.0 compatible. Used
for data transfer.

Ground Terminal

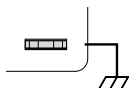

Accepts the DUT ground lead for common ground.

Probe Compensation Outputs



The probe compensation output is used for probe compensation. It also has an adjustable output frequency.

By default this port outputs a 2Vpp, square wave signal at 1kHz for probe compensation.

Please see page 188 for details.

Power Switch



POWER

Used to turn the power on/off.



■ | ○ : ON

■ | ○ : OFF

Rear Panel

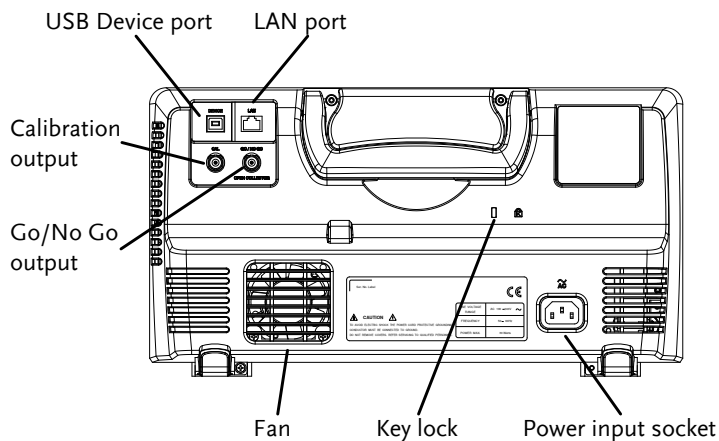

Calibration Output

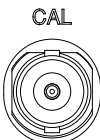

Outputs the signal for vertical scale accuracy calibration (page 263).

USB Device Port

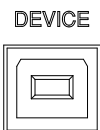

The USB Device port is used for remote control.

LAN (Ethernet) Port

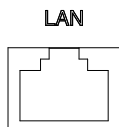

The LAN port is used for remote control over a network or when combined with the Remote Disk app, allows the scope to be mounted to a share disk.

Power Input
Socket

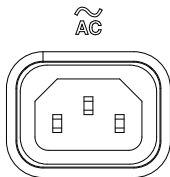

Power cord socket accepts AC
mains, 100 ~ 240V, 50/60Hz.

For power up sequence, see page
28.

Security Slot



Kensington security slot
compatible.

Go-No Go
Output

GO / NO GO



Outputs Go-No Go test results
(page 193) as a 500us pulse signal.

OPEN COLLECTOR

Display

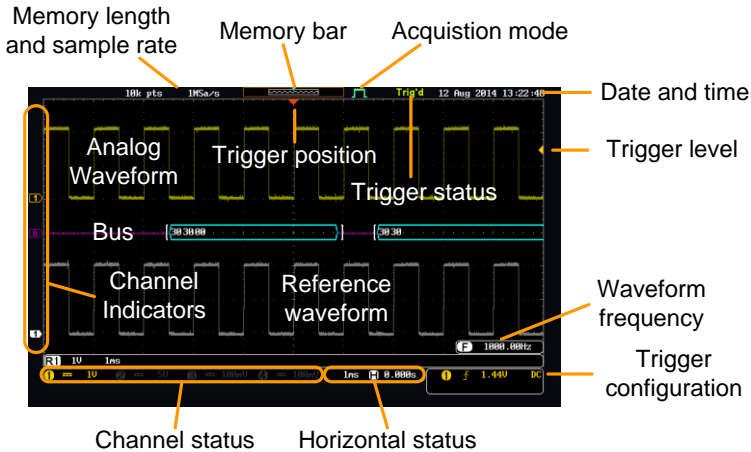

Analog Waveforms

Shows the analog input signal waveforms.





- Channel 1: Yellow
- Channel 2: Blue
- Channel 3: Pink
- Channel 4: Green

Bus Waveforms

Shows the bus waveforms for serial buses. The values are displayed in hex or binary.

Channel Indicators

The channel indicators show the zero volt level of the signal waveform for each activated channel. Any active channel is shown with a solid color.

-  Analog channel indicator
-  Bus indicator(B)
-  Reference waveform indicator
-  Math indicator

Trigger Position Shows the position of the trigger.

Horizontal Status Shows the horizontal scale and position.

Date and Time **12 Aug 2014 13:22:48**

Current date and time (page 187).



Trigger Level  Shows the trigger level on the graticule.

Memory Bar 

The ratio and the position of the displayed waveform compared to the internal memory (page 104).

- Trigger Status Trig'd Triggered.
- PrTrig Pre-trigger.
- Trig? Not triggered, display not updated.
- Stop Trigger stopped. Also appears in Run/Stop (page 41).
- Roll Roll mode.
- Auto Auto trigger mode.

For trigger details, see page 144.

- Acquisition Mode  Normal mode
-  Peak detect mode
-  Average mode

For acquisition details, see page 80.

Signal Frequency  Shows the trigger source frequency.

 Indicates the frequency is less than 2Hz (lower frequency limit).

Trigger Configuration  Trigger source, slope, voltage, coupling.

Horizontal Status  Horizontal scale, horizontal position.

For trigger details, see page 144.

Channel Status  Channel 1, DC coupling, 2V/Div.

For channel details, see page 113.

Set Up

Tilt Stand

Tilt

To tilt, pull the legs forward, as shown below.

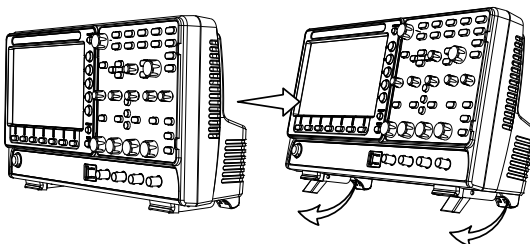

Stand

To stand the scope upright, push the legs back under the casing as shown below.

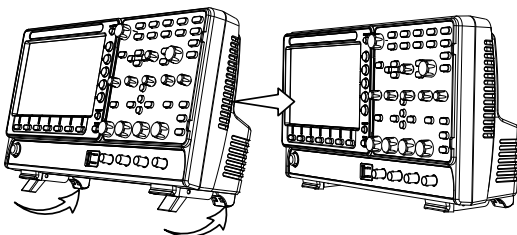

Power Up

Requirements The GDS-2000E accepts line voltages of 100 ~ 240V at 50 or 60Hz.

Step 1. Connect the power cord to the rear panel socket.

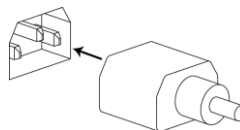

2. Press the POWER key. The display becomes active in ~ 30 seconds.

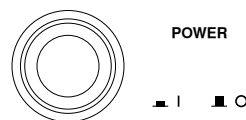

■ | : ON

■ ○ : OFF



The GDS-2000E recovers the state right before the power is turned OFF. The default settings can be recovered by pressing the Default key on the front panel. For details, see page 231.

First Time Use

Background This section describes how to connect a signal, adjust the scale, and compensate the probe. Before operating the GDS-2000E in a new environment, run these steps to make sure the instrument performs at its full potential.

1. Power On Follow the procedures on the previous page.

2. Set the Date and Time Set the date and time. Page 187

3. Reset System Reset the system by recalling the factory settings. Press the *Default* key on the front panel. For details, see page 231.

Default

4. Connect Probe Connect the probe to the Channel 1 input and to the CAL signal output. This output provides a 2V_{p-p}, 1kHz square wave for signal compensation by default.

Set the probe attenuation to x10 if the probe has adjustable attenuation.

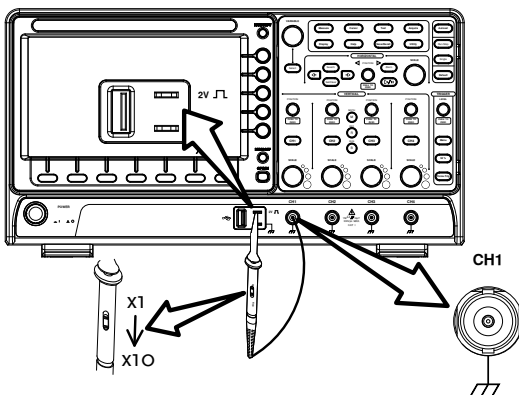

5. Capture Signal (Autoset)

Press the *Autoset* key. A square waveform appears on the center of the screen. For Autoset details, see page 39.

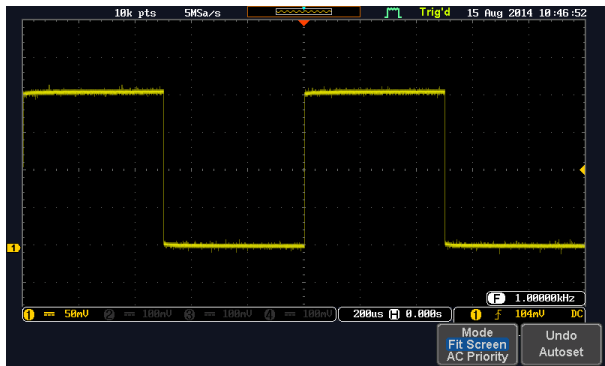
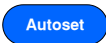

6. Select Vector Waveform

Press the *Display* key, and set the display to *Vector* on the bottom menu.

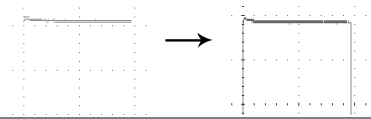
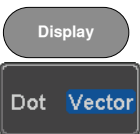

7. Compensate Probe

Turn the adjustment point on the probe to make the square waveform edge flat.

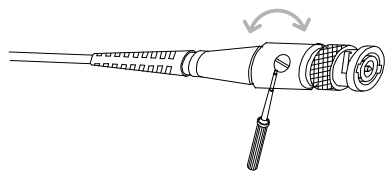
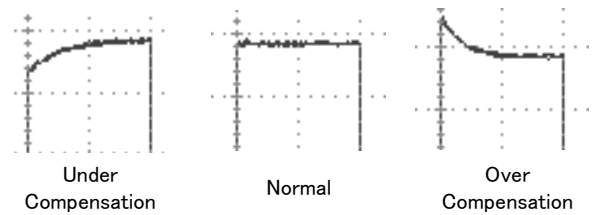

8. Start Operation Continue with the other operations.

Measurement: page 37	Configuration: page 77
Save/Recall: page 213	File Utilities: page 238
Apps: page 190	Hardcopy key: page 245
Remote Control: page 249	Maintenance: page 261

How to Use This Manual

Background This section describes the conventions used in this manual to operate the GDS-2000E.

Throughout the manual any reference to pressing a menu key refers to the keys directly below or beside any menu icons or parameters.

When the user manual says to “toggle” a value or parameter, press the corresponding menu item. Pressing the item will toggle the value or parameter.

Active parameters are highlighted for each menu item. For example in the example below, Coupling is currently set to DC.

If a menu item can be toggled from one value or parameter to another, the available options will be visible, with the current option highlighted. In the example below the slope can be toggled from a rising slope to a falling slope or either slope.

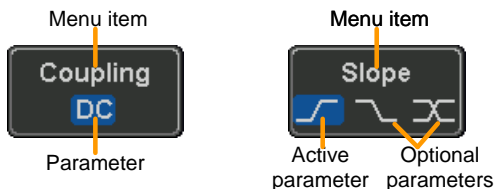

Selecting a Menu Item, Parameter or Variable

When the user manual says to “select” a value from one of the side menu parameters, first press the corresponding menu key and use the Variable knob to either scroll through a parameter list or to increase or decrease a variable.

Example 1

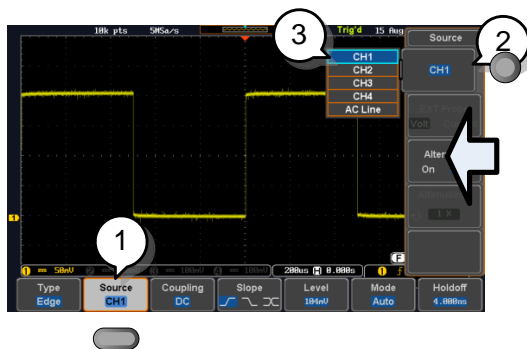

1. Press a bottom menu key to access the side menu.

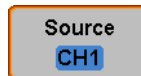

2. Press a side menu key to either set a parameter or to access a sub menu.



3. If accessing a sub menu or setting a variable parameter, use the Variable knob to scroll through menu items or variables. Use the Select key to confirm and exit.

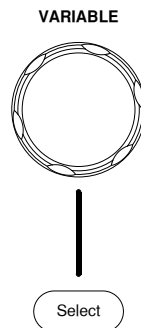

4. Press the same bottom menu key again to reduce the side menu.

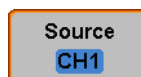

Example 2 For some variables, a circular arrow icon indicates that the variable for that menu key can be edited with the Variable knob.

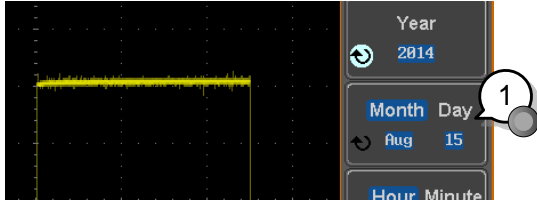

1. Press the desired menu key to select it. The circular arrow will become highlighted.



2. Use the Variable knob to edit the value.

Toggling a Menu Parameter

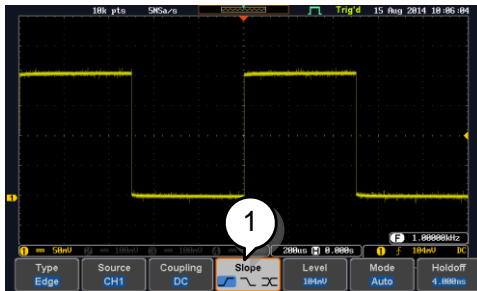

1. Press the bottom menu key to toggle the parameter.



Reduce Side Menu

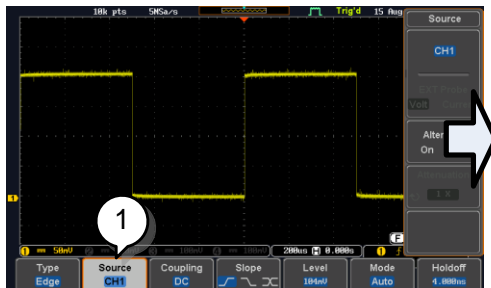

1. To reduce the side menu, press the corresponding bottom menu that brought up the side menu.

For example: Press the *Source* soft-key to reduce the Source menu.

Reduce Lower Menu

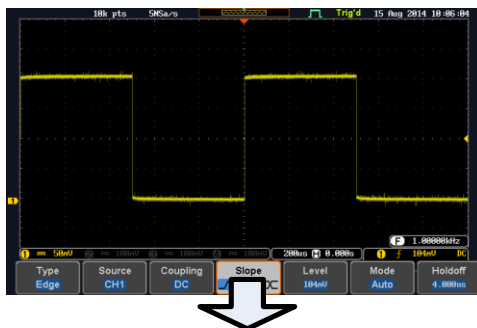

1. Press the relevant function key again to reduce the bottom menu. For example: press the Trigger Menu key to reduce the trigger menu.

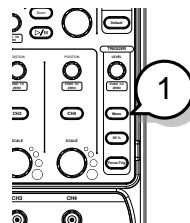

Remove All Menus

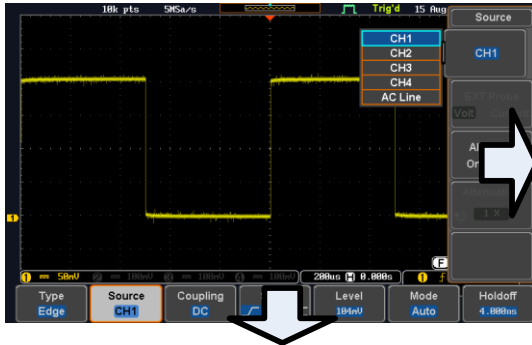

1. Press the *Menu Off* key to reduce the side menu, press again to reduce the bottom menu.

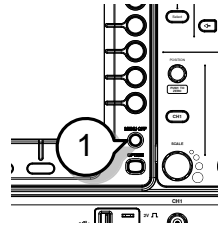

Remove On-Screen Messages

1. The *Menu Off* key can also be used to remove any on screen messages.

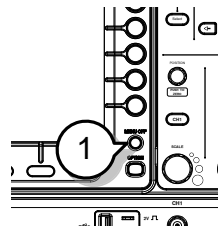

Built-in Help

The Help key accesses a context sensitive help menu. The help menu contains information on how to use the front panel keys.

Panel Operation 1. Press the *Help* key. The display changes to Help mode.



2. Use the *Variable* knob to scroll up and down through the Help contents. Press *Select* to view the help on the selected item.

Example: Help on the Display key

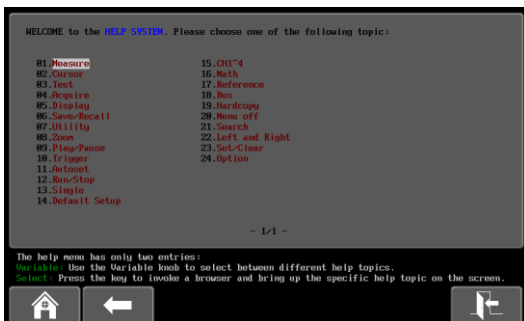

Home Key Press the *Home* key to return to the main help screen.



Go Back Press the *Back* key to go to the previous menu page.



Exit Press the *Help* key again or press the *Exit* key to exit the Help mode.

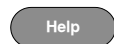

M EASUREMENT

Basic Measurement	38
Channel Activation	38
Autoset	39
Run/Stop	41
Horizontal Position/Scale.....	42
Vertical Position/Scale	44
Automatic Measurement	45
Measurement Items	45
Add Measurement.....	49
Remove Measurement.....	51
Gated mode	52
Display All mode.....	53
High Low Function	54
Statistics	55
Reference Levels	58
Cursor Measurement	59
Use Horizontal Cursors.....	59
Use Vertical Cursors	63
Math Operation	67
Basic Math Overview & Operators	67
Addition/Subtraction/Multiplication/Division.....	67
FFT Overview & Window Functions	69
FFT Operation	70
Advanced Math Overview	72
Advanced Math Operation	73

Basic Measurement

This section describes the basic operations required in capturing and viewing the input signal. For more detailed operations, see the following chapters.

- Cursor Measurement → from page 59
- Configuration → from page 77

Before operating the oscilloscope, please see the Getting Started chapter, page 10.

Channel Activation

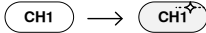
Activate Channel To activate an input channel, press a *channel* key. 

When activated, the channel key will light up. The corresponding channel menu will also appear.

Each channel is associated with the color shown beside each channel's vertical SCALE dial: CH1: yellow, CH2: blue, CH3: pink and CH4: green.

When a channel is activated, it is shown above the bottom menu system.

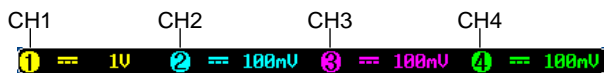

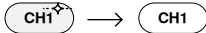
De-activate Channel To de-activate a channel, press the corresponding *channel* key again. If the channel menu is not open, press the *channel* key twice (the first press shows the Channel menu). 

Default Setup To activate the default state, press *Default*. Default

Autoset

Background The Autoset function automatically configures the panel settings to position the input signal(s) to the best viewing condition. The GDS-2000E automatically configures the following parameters:

- Horizontal scale
- Vertical scale
- Trigger source channel

There are two operating modes for the Autoset function: Fit Screen Mode and AC Priority Mode.

Fit Screen Mode will fit the waveform to the best scale, including any DC components (offset). AC priority mode will scale the waveform to the screen by removing any DC component.

Panel Operation 1. Connect the input signal to the GDS-2000E and press the *Autoset* key. Autoset

2. The waveform appears in the center of the display.

Before

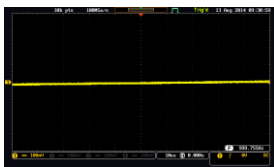

After



3. To undo Autoset, press *Undo Autoset* from the bottom menu.

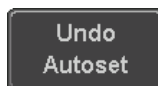

Change modes

1. Choose between *Fit Screen Mode* and *AC Priority Mode* from the bottom menu.



2. Press the *Autoset* key again to use Autoset in the new mode.



Fit Screen Mode

AC Priority

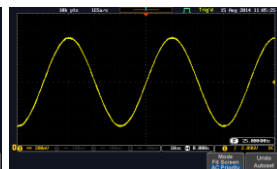
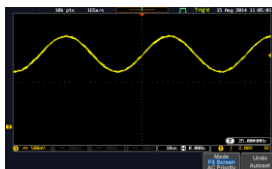

Limitation

Autoset does not work in the following situations:

- Input signal frequency is less than 20Hz
- Input signal amplitude is less than 10mV



Note

The Autoset key does NOT automatically activate the channels to which input signals are connected.

Run/Stop

Background By default, the waveform on the display is constantly updated (Run mode). Freezing the waveform by stopping signal acquisition (Stop mode) allows flexible observation and analysis. To enter Stop mode, two methods are available: pressing the Run/Stop key or using the Single Trigger mode.

Stop mode icon When in Stop mode, the Stop icon appears at the top of the display.

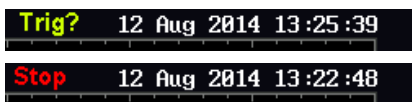

Triggered icon

Freeze Waveform using the Run/Stop Key

Press the *Run/Stop* key once. The Run/Stop key turns red. The waveform and signal acquisition freezes.

Stop:

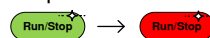

To unfreeze, press the *Run/Stop* key again. The Run/Stop key turns green again.

Run:

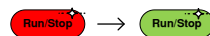

Freeze Waveform by Single Trigger Mode

Press the *Single* key to go into the Single Trigger mode. The Single key turns bright white.

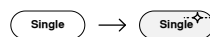

In the Single Trigger mode, the scope will be put into the pre-trigger mode until the scope encounters the next trigger point. After the scope has triggered, it will remain in Stop mode, until the *Single* key is pressed again or the *Run/Stop* key is pressed.

Waveform Operation The waveform can be moved or scaled in both Run and Stop mode, but in different manners. For details, see page 104 (Horizontal position/scale) and page 113 (Vertical position/scale).

Horizontal Position/Scale

For more detailed configuration, see page 104.

Set Horizontal Position The horizontal position knob moves the waveform left and right.

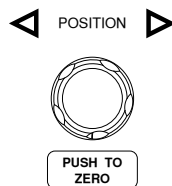

Set Horizontal Position to 0 Pressing the horizontal position knob will reset the horizontal position to 0.

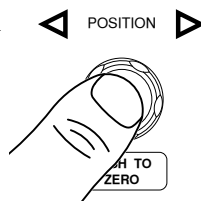

Alternatively, pressing the *Acquire* key and then pressing *Reset H Position to 0s* from the bottom menu will also reset the horizontal position.



As the waveform moves, the display bar on the top of the display indicates the portion of the waveform currently shown on the display and the position of the horizontal marker on the waveform.



Position Indicator The horizontal position is shown at the bottom of the display grid to the right of the H icon.



Select Horizontal Scale To select the timebase, turn the horizontal *SCALE* knob; left (slow) or right (fast).

SCALE

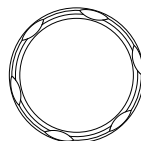

Range 1ns/div ~ 100s/div, 1-2-5 increments

The scale is displayed to the left of the H icon at the bottom of the screen.



Display bar The display bar indicates how much of the waveform is displayed on the screen at any given time. Changes to timebase will be reflected on the display bar.

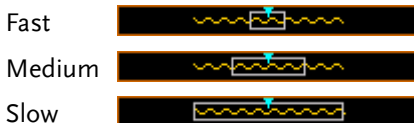

Stop mode In the Stop mode, the waveform size changes according to the scale.

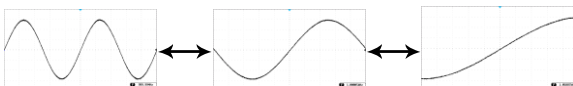

 **Note**

The Sample rate changes according to the timebase and record length. See page 84.

Vertical Position/Scale

For more detailed configuration, see page 113.

Set Vertical Position

To move the waveform up or down, turn the *vertical position knob* for each channel.

POSITION



PUSH TO ZERO

Push the *vertical position knob* to reset the position to 0.

As the waveform moves, the vertical position of the cursor appears on the display.

POSITION

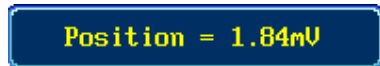
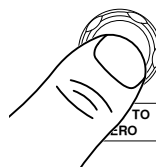

Run/Stop mode

The waveform can be moved vertically in both Run and Stop mode.

Select Vertical Scale

To change the vertical scale, turn the vertical *SCALE knob*; left (down) or right (up).

SCALE

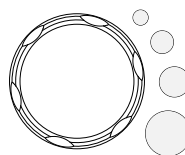

Range

1mV/div ~ 10V/div
1-2-5 increments

The vertical scale indicator for each channel on the bottom of the display changes accordingly.











Automatic Measurement

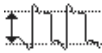

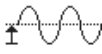
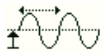
The automatic measurement function measures and updates major items for Voltage/Current, Time, and Delay type measurements.











Measurement Items









	V/I Measurements	Time Meas.	Delay Meas.
Overview	Pk-Pk		Frequency
	Max		Period
	Min		RiseTime
	Amplitude		FallTime
	High		+Width
	Low		-Width
	Mean		Dutycycle
	Cycle Mean		+Pulses
	RMS		-Pulses
	Cycle RMS		+Edges
	Area		-Edges
	Cycle Area		
	ROVShoot		
	FOVShoot		
	RPREShoot		
FPREShoot			

Voltage/Current Measurement	Pk-Pk (peak to peak)		Difference between positive and negative peak. (=max - min)
	Max		Positive peak.
	Min		Negative peak.

Amplitude		Difference between the global high value and the global low value, measured over the entire waveform or gated region. (=high – low)
High		Global high voltage. See page 54 for details.
Low		Global low voltage. See page 54 for details.
Mean		The arithmetic mean value is calculated for all data samples as specified by the Gating option.
Cycle Mean		The arithmetic mean value is calculated for all data samples within the first cycle found in the gated region.
RMS		The root mean square of all data samples specified by the Gating option.
Cycle RMS		The root mean square value is calculated for all data samples within the first cycle found in the gated region.
Area		Measures the positive area of the waveform and subtracts it from the negative area. The ground level determines the division between positive and negative areas.
Cycle Area		The Summation based on all data samples within the first cycle found in the gated region.
ROVShoot		Rise overshoot

FOVShoot		Fall overshoot
RPREShoot		Rise preshoot
FPREShoot		Fall preshoot

Time Measurement	Frequency		Frequency of the waveform.
	Period		Waveform cycle time. (=1/Freq)
	RiseTime		The time required for the leading edge of the first pulse to rise from the low reference value to the high reference value.
	FallTime		The time required for the falling edge of the first pulse to fall from the high reference value to the low reference value.
	+Width		Positive pulse width.
	-Width		Negative pulse width.
	Duty Cycle		Ratio of signal pulse compared with whole cycle. =100x (Pulse Width/Cycle)
	+Pulses		Measures the number of positive pulses.
	-Pulses		Measures the number of negative pulses.
	+Edges		Measures the number of positive edges.

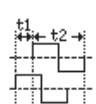
	-Edges		Measures the number of negative edges.
Delay Measurement	FRR		Time between: Source 1 first rising edge and Source 2 first rising edge.
	FRF		Time between: Source 1 first rising edge and Source 2 first falling edge.
	FFR		Time between: Source 1 first falling edge and Source 2 first rising edge.
	FFF		Time between: Source 1 first falling edge and Source 2 first falling edge.
	LRR		Time between: Source 1 last rising edge and Source 2 last rising edge.
	LFR		Time between: Source 1 last rising edge and Source 2 last falling edge.
	LRF		Time between: Source 1 last falling edge and Source 2 last rising edge.
	LFF		Time between: Source 1 last falling edge and Source 2 last falling edge.
	Phase		The phase difference of two signals, calculated in degrees. $\frac{t1}{t2} \times 360^\circ$



Note

The in-built help system can be used to see detailed automatic measurement definitions.

Add Measurement

The *Add Measurement* function allows you to add up to eight automatic measurement items on the bottom of the screen from any channel source.

Add Measurement Item

1. Press the *Measure* key.



2. Press *Add Measurement* from the bottom menu.

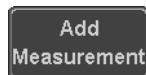

3. Choose either a *V/I*, *Time* or *Delay* measurement from the side menu and choose the type of measurement you wish to add.

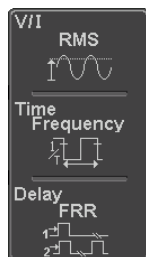

V/I (Voltage/ Current)	Pk-Pk, Max, Min, Amplitude, High, Low, Mean, Cycle Mean, RMS, Cycle RMS, Area, Cycle Area, ROVShoot, FOVShoot, RPRESshoot, FPRESshoot
Time	Frequency, Period, RiseTime, FallTime, +Width, -Width, Duty Cycle, +Pulses, -Pulses, +Edges, -Edges
Delay	FRR, FRF, FFR, FFF, LRR, LRF, LFR, LFF, Phase

- All of the chosen automatic measurements will be displayed in a window on the bottom of the screen. The channel number and channel color indicate the measurement source.

For the analog inputs: yellow = CH1,
blue = CH2, pink = CH3, green = CH4.



Choose a Source The channel source for measurement items can be set either before or when selecting a measurement item.

- To set the source, press either the *Source1* or *Source2* key from the side menu and choose the source. Source 2 is only applicable for delay measurements.



Range CH1~ CH4, Math

Remove Measurement

Individual measurements can be removed at any time using the Remove Measurement function.

Remove
Measurement
Item

1. Press the *Measure* key.
2. Press *Remove Measurement* from the bottom menu.
3. Press *Select Measurement* and select the item that you want to remove from the measurement list.

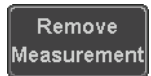
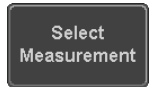
A rounded rectangular button with the text "Measure" inside.A rectangular button with rounded corners and a dark background, containing the text "Remove Measurement" in white.A rectangular button with rounded corners and a dark background, containing the text "Select Measurement" in white.

Remove All Items Press *Remove All* to remove all the measurement items.

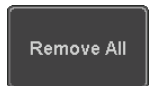
A rectangular button with rounded corners and a dark background, containing the text "Remove All" in white.

Gated mode

Some automatic measurements can be limited to a “gated” area between cursors. Gating is useful for measuring a magnified waveform or when using a fast time base. The Gated mode has three possible configurations: Off (Full Record), Screen and Between Cursors.

Set Gating Mode 1. Press the *Measure* key.



2. Press *Gating* from the bottom menu.



3. Choose one of the gating modes from the side menu: *Off (full record)*, *Screen*, *Between Cursors*.

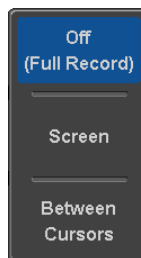

Cursors On Screen

If *Between Cursors* is selected, the cursor positions can be edited by using the cursor menu.

Page 59

Display All mode

Display All mode shows and updates all items from Voltage and Time type measurements.

View Measurement Results

1. Press the *Measure* key.
2. Press *Display All* from the bottom menu.
3. Press *Source* from the side menu and choose a measurement source.

Range CH1~CH4, Math
4. The results of Voltage and Time type measurements appear on the display.

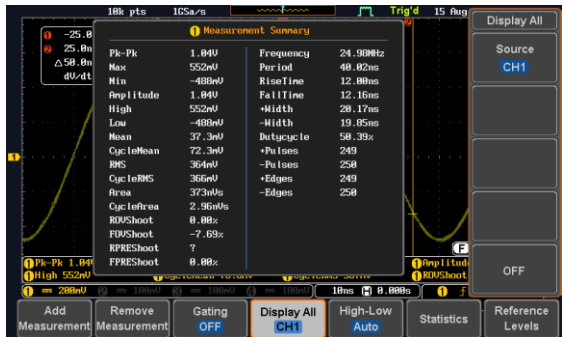
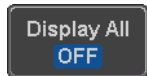

Remove Measurements

To remove the measurement results, press *OFF*.



Delay Measurements

Delay type measurements are not available in this mode as only one channel is used as the source. Use the individual measurement mode (page 49) instead.

High Low Function

Background The High-Low function is used to select the method for determining the value of the High-Low measurement values.

- Auto** Automatically chooses the best high-low setting for each waveform when measuring.
- Histogram** Uses histograms to determine the high-low values. This mode ignores any preshoot and overshoot values. This mode is particularly useful for pulse-type waveforms

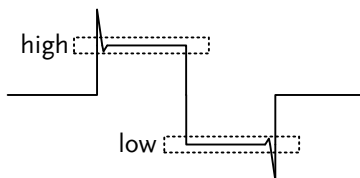

- Min-max** Sets the high-low values as the minimum or maximum measured values.

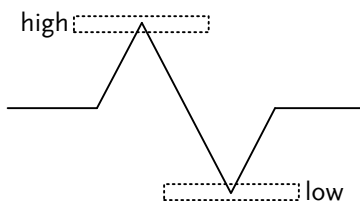

Set High-Low

1. Press the *Measure* key.
2. Press *High-Low* from the bottom menu.



3. Select the type of High-Low settings from the side menu.

High-Low Settings: Histogram, Min-Max, Auto

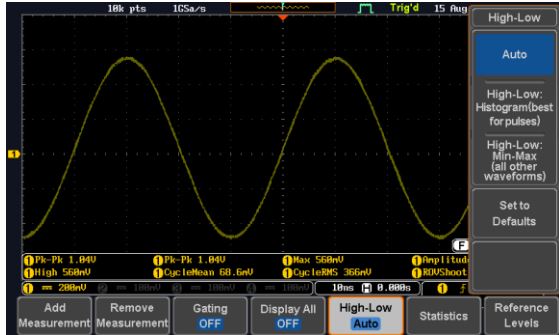

Restore Default High-Low Settings

To return to the default High-Low settings, press *Set to Defaults*.

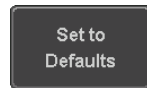



Statistics

Background

The Statistics function can be used to view a number of statistics for the selected automatic measurements. The following information is displayed with the Statistics function:

Value	Currently measured value
Mean	The mean value is calculated from a number of automatic measurement results. The number of samples used to determine the mean can be user-defined.
Min	The minimum value observed from a series of measured results for the selected automatic measurement items.

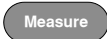
Max	The maximum value observed from a series of measured results for the selected automatic measurement items.
Standard Deviation	The variance of the currently measured value from the mean. The standard deviation equals the squared root of the variance value. Measuring the standard deviation can, for example, determine the severity of jitter in a signal. The number of samples used to determine the standard deviation can be user-defined.

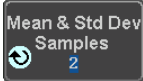
- Panel Operation
1. Press the *Measure* key. 
 2. Select at least one automatic measurement. Page 49
 3. Press *Statistics* from the bottom menu. 
 4. Set the number of samples to be used in the mean and standard deviation calculations. 

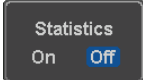
Samples: 2~1000
 5. Press *Statistics* and turn Statistics on. 
 6. The statistics for each automatic measurement will appear at the bottom of the display in a table.

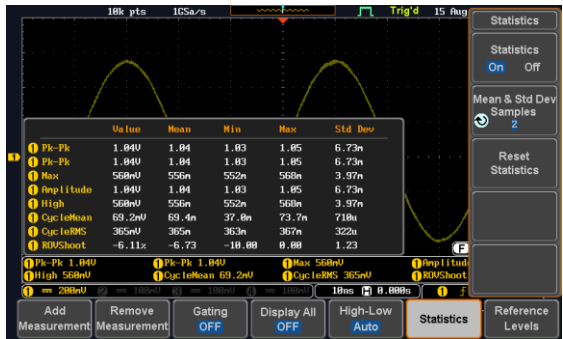

Reset Statistics To reset the standard deviation calculations, press *Reset Statistics*.

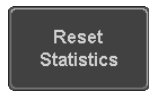

Reference Levels

Background The reference level settings determine the measurement threshold levels for some measurements like the Rise Time measurement.

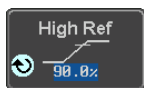

High Ref: Sets the high reference level.

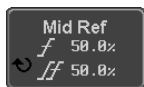

Mid Ref: Sets the middle reference for the first and second waveforms.

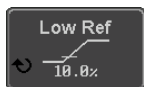

Low Ref: Sets the low reference level.

Panel Operation 1. Press the *Measure* key.



2. Press *Reference Levels* from the bottom menu.

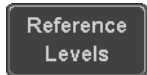

3. Set the reference levels from the side menu.

Ensure the reference levels do not cross over.

High Ref 0.0% ~ 100%

Mid Ref 0.0% ~ 100%

0.0% ~ 100%

Low Ref 0.0% ~ 100%

Default Settings 4. Press *Set to Defaults* to set the reference levels back to the default settings.

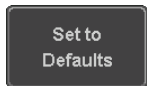

Cursor Measurement

Horizontal or vertical cursors are used to show the position and values of waveform measurements and math operation results. These results cover voltage, time, frequency and other math operations. When the cursors (horizontal, vertical or both) are activated, they will be shown on the main display unless turned off.

Use Horizontal Cursors

Panel Operation 1. Press the *Cursor* key once.

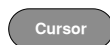

2. Press *H Cursor* from the bottom menu if it is not already selected.

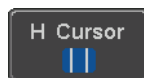

3. When the H Cursor is selected, repeatedly pressing the *H Cursor* key or the *Select* key will toggle which cursor is selected.



OR



Range	Description
⋮	Left cursor (1) movable, right cursor position fixed
⋮	Right cursor (2) movable, left cursor position fixed
	Left and right cursor (1+2) movable together

4. The cursor position information appears on the top left hand side of the screen

①	-3.74ms	1.40V
②	7.84ms	1.40V
△	11.5ms	△0.00V
	dV/dt	0.00V/s

- Cursor ① Hor. position, Voltage/Current
- Cursor ② Hor. position, Voltage/Current
- △ Delta (difference between cursors)
- dV/dt or dI/dt

5. Use the *Variable* knob to move the movable cursor(s) left or right.



Select Units

6. To change the units of the horizontal position, press *H Unit*.

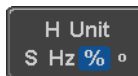

Units S, Hz, % (ratio), °(phase)

Phase or Ratio Reference

7. To set the 0% and 100% ratio or the 0° and 360° phase references for the current cursor positions, press *Set Cursor Positions As 100%*.



Example

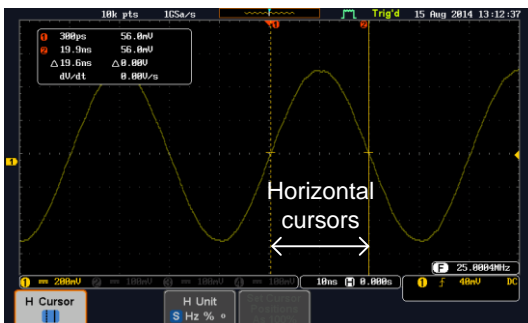

FFT

FFT cursors can use different units. For FFT details, see page 69.

□	1.0175GHz	21.2dB
○	2.2780GHz	-51.4dB
△	1.2525GHz	△72.6dB
	d/dt	-58.0ndB/Hz

- Cursor **1** Hor. position, dB/Voltage
- Cursor **2** Hor. Position, dB/Voltage
- △ Delta (difference between cursors)
dV/dt or d/dt

Example

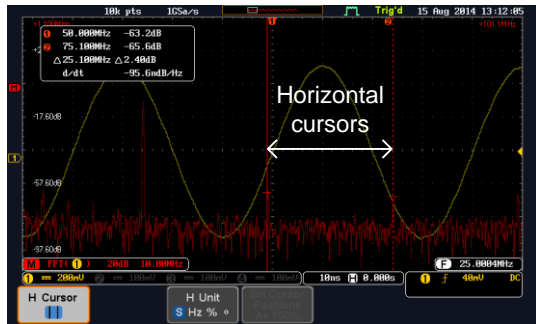

XY Mode

XY mode cursors measure a number of X by Y measurements.

	1 (X)	2 (Y)	△
Versus			
2 (Y)	t:	-625us	625us
		1.25ms	
Rectangular	x:	16.0U	17.6U
	y:	1.76U	-1.44U
		-3.20U	
Polar	r:	16.0U	17.6U
	θ:	6.27°	-4.67°
		-63.4°	
Product	x×y:	28.10U	-25.30U
		-5.12U	
Ratio	y÷x:	110mU/U	-81.8mU/U
		-2.00U/U	

- Cursor **1** Time, rectangular, polar coordinates, product, ratio.
- Cursor **2** Time, rectangular, polar coordinates, product, ratio.
- △ Delta (difference between cursors)

Example

Horizontal
Cursors

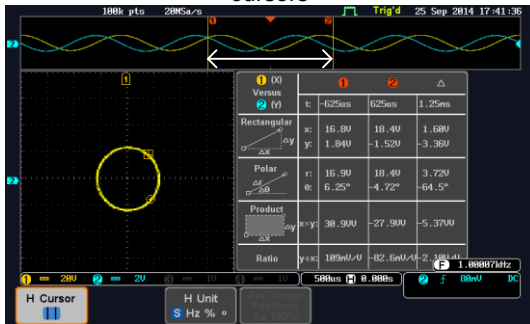

Use Vertical Cursors

Panel Operation/
Range

1. Press the *Cursor* key twice.



2. Press *V Cursor* from the bottom menu if it is not already selected.



3. When the *V Cursor* is selected, repeatedly pressing the *V Cursor* key or the *Select* key will toggle which vertical cursor is selected.



OR



Range



Upper cursor movable, lower cursor position fixed



Lower cursor movable, upper cursor position fixed



Upper and lower cursor movable together

4. The cursor position information appears on the top left hand side of the screen.

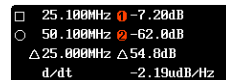

Time: cursor 1, cursor 2



Voltage/Current: cursor1, cursor2



Delta (difference between cursors)

dV/dt or dI/dt

5. Use the *Variable* knob to move the cursor(s) up or down.

VARIABLE

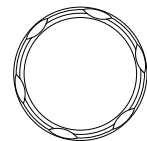

Select Units

- To change the units of the vertical position, press *V Unit*.

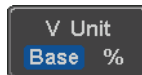

Units Base (source wave units), % (ratio)

Base or Ratio Reference

- To set the 0% and 100% ratio references for the current cursor position, press *Set Cursor Positions As 100%*.

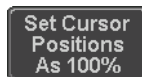

Example

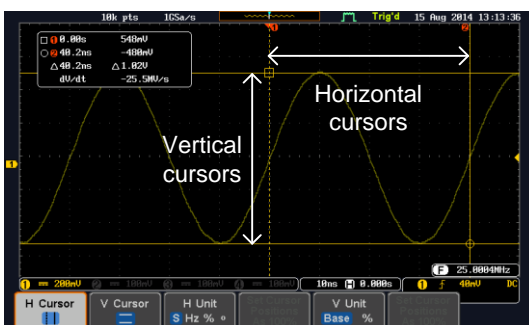

FFT

FFT has different content. For FFT details, see page 69.

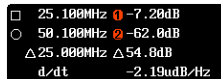

□, ○ Frequency/Time: cursor1, cursor2
 ①, ② dB/V: cursor1, cursor2
 △ Delta (difference between cursors)
 d/dt

Example

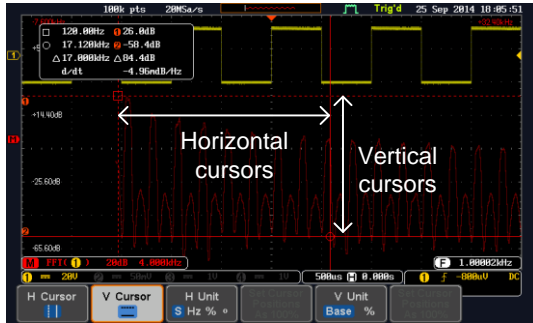

XY Mode

XY mode cursors measure a number of X by Y measurements.

<div style="display: flex; align-items: center;"> 1 (X) <div style="margin-left: 10px;"> Versus 2 (Y) </div> </div>	<div style="display: flex; justify-content: space-around; width: 100%;"> 1 2 Δ </div>			
	t:	-625us	625us	1.25ms
<div style="display: flex; align-items: center;"> <div style="margin-right: 10px;"> </div> <div> Rectangular x: y: </div> </div>	18.4U -1.44U	-14.4U -1.68U	-32.8U -248nU	
<div style="display: flex; align-items: center;"> <div style="margin-right: 10px;"> </div> <div> Polar r: θ: </div> </div>	18.4U -4.47°	14.4U -173°	32.8U -179°	
<div style="display: flex; align-items: center;"> <div style="margin-right: 10px;"> </div> <div> Product x×y: </div> </div>	-26.40U	24.10U	7.870U	
Ratio	y÷x:	-78.2nU/U	116nU/U	7.31nU/U

Cursor **1** Rectangular, polar co-ordinates, product, ratio.

Cursor **2** Rectangular, polar co-ordinates, product, ratio.

Δ Delta (difference between cursors)

Example

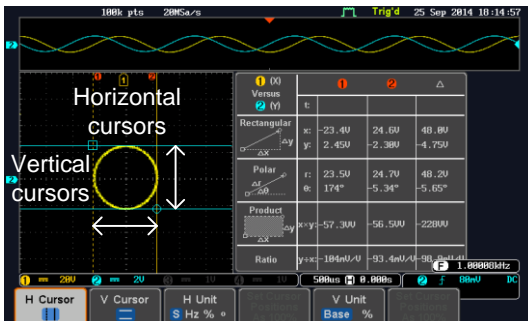

Math Operation

Basic Math Overview & Operators

Background	The Math function performs basic math functions (addition, subtraction, multiplication, division) on the input signals or the reference waveforms. The resultant waveform will be shown on the screen in real-time.
Addition (+)	Adds the amplitude of two signals. Source CH1~4, Ref1~4
Subtraction (-)	Extracts the amplitude difference between two signals. Source CH1~4, Ref1~4
Multiplication (×)	Multiplies the amplitude of two signals. Source CH1~4, Ref1~4
Division (÷)	Divides the amplitude of two signals. Source CH1~4, Ref1~4

Addition/Subtraction/Multiplication/Division

Panel Operation 1. Press the *Math* key.



2. Press the *Math* key on the lower bezel.

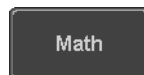

3. Select *Source 1* from the side menu



Range CH1~4, Ref1~4

4. Press *Operator* to choose the math operation.

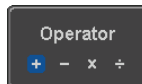

Range +, -, x, ÷

5. Select *Source 2* from the side menu.



Range CH1~4, Ref1~4

6. The math measurement result appears on the display. The vertical scale of the math waveform appears at the bottom of the screen.



From left: Math function, source1, operator, source2, Unit/div

Example

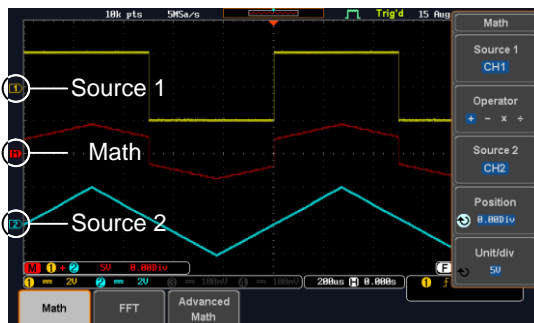

Position and Unit To move the math waveform vertically, press the *Position* key from the side menu and use the *Variable* knob to set the position.



Range -12.00 Div ~ +12.00 Div

To change the unit/div settings, press *Unit/div*, then use the *Variable* knob to change the unit/div.

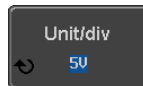

The units that are displayed depend on which operator has been selected, and whether the probe for the selected channel has been set to voltage or current.

Operator:	Unit/div:
Multiplication	VV, AA or W
Division	V/V, A/A
Addition/Subtraction	V or A

Turn Off Math

To turn off the Math result from the display, press the *Math* key again.

MATH



FFT Overview & Window Functions

Background

The FFT Math function performs a Fast Fourier Transform on one of the input signals or the reference waveforms. The resultant spectrum will be shown on the screen in real-time. Four types of FFT windows are available: Hanning, Hamming, Rectangular, and Blackman, as described below.

Hanning FFT Window

Frequency resolution	Good
Amplitude resolution	Not good
Suitable for...	Frequency measurement on periodic waveforms

Hamming FFT Window	Frequency resolution	Good
	Amplitude resolution	Not good
	Suitable for...	Frequency measurement on periodic waveforms
Rectangular FFT Window	Frequency resolution	Very good
	Amplitude resolution	Bad
	Suitable for...	Single-shot phenomenon (this mode is the same as having no window at all)
Blackman FFT Window	Frequency resolution	Bad
	Amplitude resolution	Very good
	Suitable for...	Amplitude measurement on periodic waveforms

FFT Operation

- Panel Operation
- Press the *Math* key.

MATH

 - Press *FFT* from the bottom menu.

 - Select the *Source* from the side menu.



Range CH1~4, Ref~4
 - Press the *Vertical Units* key from the side menu to select the vertical units used.



Range Linear RMS, dBV RMS

- Press the *Window* key from the side menu and select the window type.

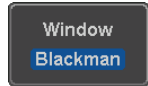

Range Hanning, Hamming, Rectangular, and Blackman.

- The FFT result appears. For FFT, the horizontal scale changes from time to frequency, and the vertical scale from voltage/current to dB/RMS.

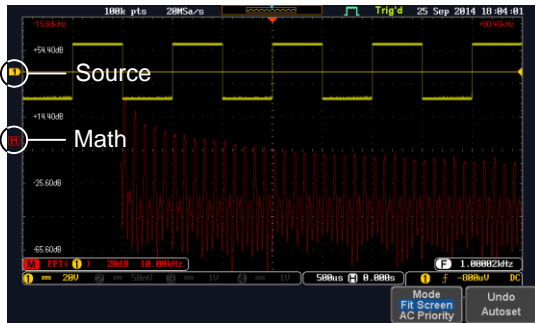

Position and Scale

To move the FFT waveform vertically, press *Vertical* until the *Div* parameter is highlighted and then use the Variable knob.

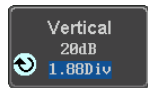

Range -12.00 Div ~ +12.00 Div

To select the vertical scale of the FFT waveform, press *Vertical* until the *dB* or *voltage* parameters are highlighted and then use the Variable knob.



Range 2mV~1kV RMS, 1~20 dB

Horizontal Position and Scale

To move the FFT waveform horizontally, press *Horizontal* until the *Frequency* parameter is highlighted and then use the Variable knob.

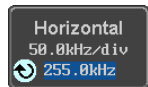

Range 0Hz ~ 2.5MHz

To select the horizontal scale of the FFT waveform, press *Horizontal* repeatedly until the *Hz/div* parameter is highlighted and then use the Variable knob.

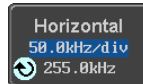

Range 10kHz/Div ~ 250kHz/Div

Advanced Math Overview

Background The advanced math function allows complex math expressions to be created based on the input sources, reference waveforms or even the automatic measurements available from the *Measure* menu (see page 45).

An overview of each of the major parameters that can be used in the advanced math function are shown below:

Expression Displays the function expression as it is created.

Source Selects the source signal.
 Source CH1~4, Ref1~4

Function Adds a mathematical function to the expression.
 Function Intg, Diff, log, Ln, Exp, Sqrt, Abs, Rad, Deg, Sin, Cos, Tan, Asin, Acos, Atan

Variable Adds a user-specified variable to the expression.
 Source CH1~4, Ref1~4

Operator Adds an operator or parenthesis to the function expression.
 Operator +, -, *, /, (,), !, <, >, <=, >=, ==, !=, |, |, &&

Figure	Adds a value to the expression.
Figure	Integers, floating point, or floating point with exponent values.

Measurement	Adds automatic measurements to the expression. Not all automatic measurements are supported.
Measurement	Pk-Pk, Max, Min, Amp, High, Low, Mean, CycleMean, RMS, CycleRMS, Area, CycleArea, ROVShoot, FOVShoot, Freq, Period, Rise, Fall, PosWidth, NegWidth, Dutycycle, FRR, FRF, FFR, FFF, LRR, LRF, LFR, LFF, Phase, RPRFShoot, FPRFShoot, +Pulses, -Pulses, +Edges, -Edges

Advanced Math Operation

- Panel Operation
1. Press the *Math* key.

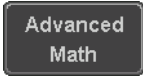

 2. Press *Advanced Math* from the bottom menu.

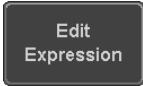
 3. Press *Edit Expression*.

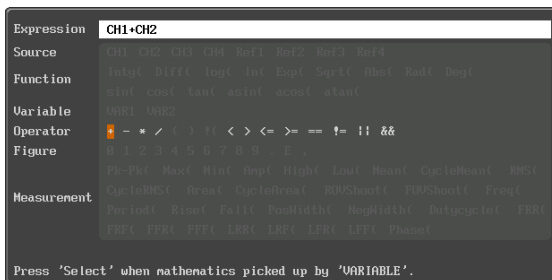
 4. The Edit f(x) screen appears. CH1 + CH2 is shown in the expression box as an example at startup.

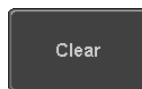

5. Press *Clear* to clear the expression entry area.



6. Use the *Variable* knob and *Select* key to create an expression.

Use the *Variable* knob to highlight a source, function, variable, operator, figure or measurement in orange.

Press the *Select* key to make the selection.

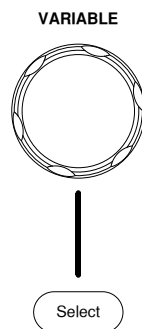

If a particular parameter is grayed out, it indicates that that particular parameter is not available at that time.

Back Space

7. To delete the last parameter press *Back Space*.



8. When the expression is complete, press *OK Accept*.

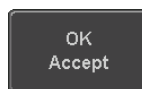

Example:
CH1 + CH2

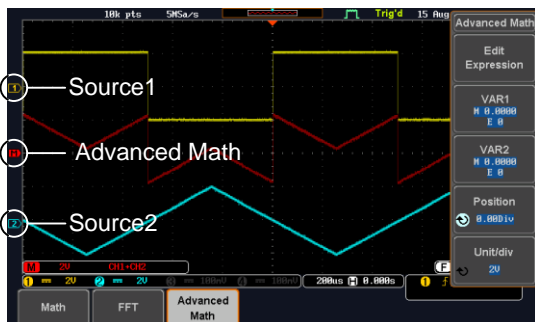

Set the VAR1 & VAR2

9. Press *VAR1* or *VAR2* to set VAR1/VAR2 if they were used in the expression created previously.

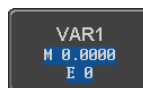

10. Press *Mantissa*.

Use the *Left* and *Right* arrow keys to select a digit and use the variable knob to set the value of the selected digit.



11. Press *Exponent*.

Use the Variable knob to set the exponent of the variable.

12. Press *Go Back* to finish editing VAR1 or VAR2.

Vertical Position and Scale

13. Press *Unit/div* and use the Variable knob to set the vertical scale of the math waveform.

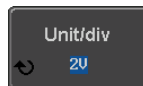

14. Press *Position* and use the Variable knob to set the vertical position of the math waveform on the display.



Clear Advanced
Math

To clear the advanced math result
from the display, press the *Math* key
again.

MATH



C ONFIGURATION

Acquisition.....	80
Select Acquisition Mode.....	80
Show Waveform in XY Mode.....	82
Set the Record Length.....	84
Segmented Memory Acquisition Overview	85
Segments Display	87
Set the Number of Segments.....	88
Run Segmented Memory.....	89
Navigate Segmented Memory	91
Play Through Each Segment.....	91
Segment Measurement	93
Automatic Measurement.....	93
Segment Info	97
Display.....	98
Display Waveform as Dots or Vectors	98
Set the Level of Persistence	99
Set the Intensity Level.....	99
Select Display Graticule	102
Freeze the Waveform (Run/Stop).....	103
Turn Off Menu.....	103
Horizontal View	104
Move Waveform Position Horizontally.....	104
Select Horizontal Scale.....	105
Select Waveform Update Mode	106
Zoom Waveform Horizontally	107
Play/Pause	110
Vertical View (Channel)	113
Move Waveform Position Vertically	113
Select Vertical Scale	114

Select Coupling Mode	114
Input Impedance	115
Invert Waveform Vertically	115
Limit Bandwidth	116
Expand by Ground/Center	117
Select Probe Type	118
Select Probe Attenuation Level	119
Set the Deskew	119
Bus Key Configuration	121
Bus Display	121
Serial Bus	123
Serial Bus Overview	123
UART Serial Bus Configuration	125
I ² C Serial Bus Interface	127
SPI Serial Bus Interface	128
CAN Serial Bus Interface	130
LIN Serial Bus Interface	131
Bus Encoding	132
Threshold Configuration	133
Serial Bus Event Tables	135
Event Tables Format	139
Adding a Label to the Serial Bus	140
Using Cursors with the Serial Bus	142
Trigger	144
Trigger Type Overview	144
Trigger Parameter Overview	146
Setup Holdoff Level	151
Setup Trigger Mode	152
Using the Edge Trigger	152
Using Advanced Delay Trigger	154
Using Pulse Width Trigger	155
Using Video Trigger	157
Pulse Runt trigger	158
Using Rise and Fall Trigger	160
Using the Timeout Trigger	161
Using the Bus Trigger	163
UART BUS Trigger Settings	163
I ² C Bus Trigger Settings	164
SPI Bus Trigger Settings	168
CAN Bus Trigger	170
LIN Bus Trigger	173

Common Bus Trigger Settings	175
Bus Trigger Mode.....	175
Search.....	176
Configuring Search Events	176
Copying Search Event To/From Trigger Events.....	178
Search Event Navigation.....	178
Save Search Marks.....	179
Setting/Clearing Single Search Events	180
FFT Peak.....	181
System Settings and Miscellaneous Settings	185
Select Menu Language	185
View System Information	186
Erase Memory	186
Set Date and Time	187

Acquisition

The Acquisition process samples the analog input signals and converts them into digital format for internal processing.

Select Acquisition Mode

Background	The acquisition mode determines how the samples are used to reconstruct a waveform.
Sample	This is the default acquisition mode. Every sample from each acquisition is used.
Peak detect	Only the minimum and maximum value pairs for each acquisition interval (bucket) are used. This mode is useful for catching abnormal glitches in the signal.
Average	Multiple acquired data is averaged. This mode is useful for drawing a noise-free waveform. To select the average number, use the Variable knob. Average number: 2, 4, 8, 16, 32, 64, 128, 256

Panel Operation 1. Press the *Acquire* key.



2. To set the Acquisition mode, press *Mode* on the bottom menu.

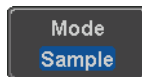

3. Select an acquisition mode from the side menu.
4. If *Average* was chosen, set the number of samples to be used for the average function.

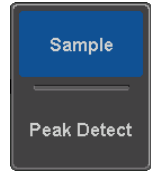

Mode	Sample, Peak Detect, Average
Average sample	2, 4, 8, 16, 32, 64, 128, 256

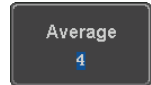

Example

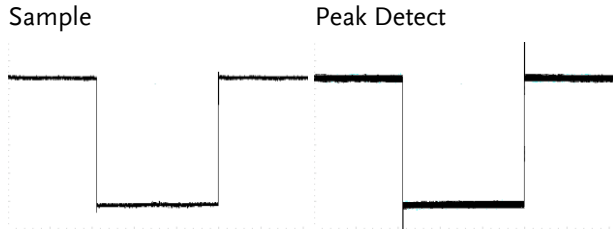

Average (256 times)

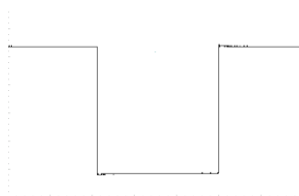

Show Waveform in XY Mode



Background The XY mode maps the input of channel 1 to the input of channel 2. In 4 channel models, the input of channel 3 can be mapped to the input of channel 4. This mode is useful for observing the phase relationship between waveforms.

Reference waveforms can also be used in XY mode. Ref1 is mapped to Ref2 and Ref3 is mapped to Ref4. Using the reference waveforms is the same as using the channel input waveforms.

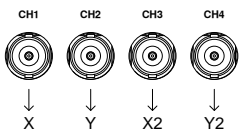
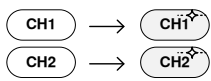
Connection

1. Connect the signals to Channel 1 (X-axis) and Channel 2 (Y-axis) or Channel 3 (X2-axis) and Channel 4 (Y2-axis).
 
2. Make sure a channel pair is active (CH1&CH2 or CH3&CH4). Press the Channel key if necessary. A channel is active if the channel key is lit.
 

Panel Operation

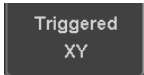
1. Press the *Acquire* menu key.
 
2. Press *XY* from the bottom menu.
 
3. Choose *Triggered XY* from the side menu.
 

X-Y mode is split into two windows. The top window shows the signals over the full time range. The bottom window shows XY mode.

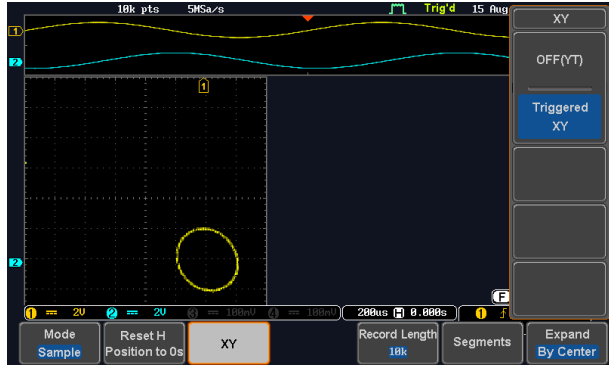

To move the X Y waveform position, use the vertical position knob: Channel 1 knob moves the X Y waveform horizontally, Channel 2 knob moves the X Y waveform vertically. Similarly, the X2 and Y2 axis can be positioned using the channel 3 and channel 4 vertical position knobs.

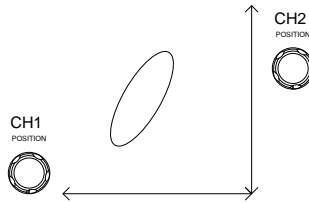

The horizontal position knob and horizontal Scale knob can still be used under the XY mode.

Turn Off XY Mode To turn off XY mode, choose *OFF (YT)* mode.



Cursors and XY Mode

Cursors can be used with XY mode. See the Cursor chapter for details.

Page 58

Set the Record Length

Background The number of samples that can be stored is set by the record length. Record length is important in an oscilloscope as it allows longer waveforms to be recorded.

The maximum record length for the GDS-2000E depends on operating mode. The table below describes the record lengths that are available for each mode.

Limitations

Record Length	Normal	Zoom	FFT
1k	✓	✗	✓
10k	✓	✓	✓
100k	✓	✓	✓
1M	✓	✓	✓
10M	✓	✓	✗

Panel Operation 1. Press the *Acquire* key.



1. Press the *Record Length* key on the bottom menu and choose the record length.

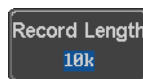

Record length 1000, 10k, 100k, 1M, 10M points



The sampling rate may also be changed when the record length is changed.

Segmented Memory Acquisition Overview

The advanced segmented memory utility allows the scope memory to be divided into different segments. Each time the scope is triggered, it only acquires data for one segment of memory at a time. This allows you to optimize the scope memory to only perform signal acquisition during important signal events.

For example, for a signal with a number of pulses, normally the oscilloscope will acquire the signal until the acquisition memory of the scope is filled up and then it will re-arm the trigger and then capture again. This could result in a number of events not being captured or captured at a less-than-desired resolution (depending on the horizontal scale and sampling rate). However, the segmented memory function would effectively allow you to capture more of the signal than you would otherwise. The diagrams below illustrate this point.

Normal acquisition mode example:

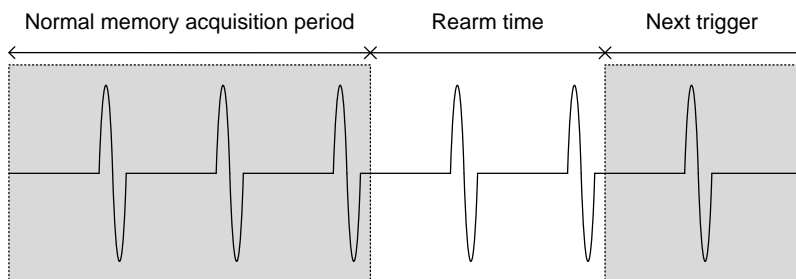

Segmented memory acquisition example:

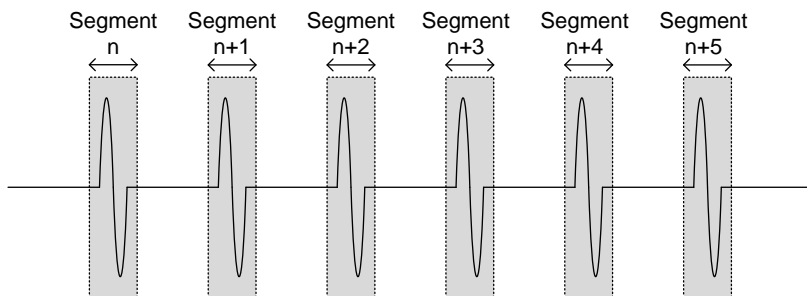

As shown above, the memory is divided into segments to increase the number of events that can be effectively captured with the same acquisition memory. Also notice that the scope doesn't need to rearm the trigger between each segment, this makes the segmented memory function especially useful for high speed signals. The time between each segment is also recorded so that accurate signal timing can also be measured.

The segmented memory function also supports automatic measurements for each segment or statistics for all the captured segments.

Segments Display

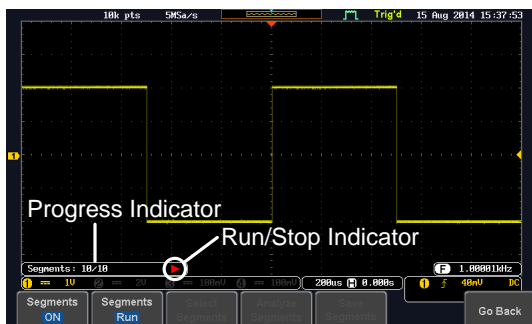

Progress Indicator

Segments : 10/10 

Indicates the number of segments that have to be captured relative to the set number of segments.

Run/Stop Indicator



Stop: The segments have finished acquiring or have been stopped.





Run: The scope is ready to acquire segments.

Set the Number of Segments

Note Before the Segment function can be used, set the trigger settings as appropriate for the signal you wish to use. The number of segments that can be used depends wholly on the record length. See page 84 to set the record length.

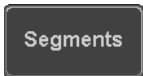
Record length	Number of segments
1000 pt.	1 ~ 29000
10k pt.	1 ~ 2900
100k pt.	1 ~ 290
1M pt.	1 ~ 20
10M pt.	1 ~ 2

- Panel Operation**
1. Press the *Acquire* key. 
 2. Press *Segments* on the bottom menu. 
 3. Press *Select Segments* and set the number of segments from the side menu. 

Num of Seg	1~29000 (record length dependant)
Set to Maximum	Sets to the maximum number
Set to Minimum	Sets to 1 segment



The Select Segments icon is only available when when Segments = OFF or when Segments is in the STOP mode (see the section below).

Run Segmented Memory

Background Before the Segmented Memory function can be used, set the trigger settings as appropriate for the signal you wish to use. See page 144 for configuring the trigger settings.

Run Segments 1. Toggle *Segments On* from the bottom menu.



The first time Segmented memory is turned on the segments will automatically be run. Each segment will be automatically captured.

2. The scope will automatically start acquiring segments. The progress of the segmented memory capture is shown in the Progress Indicator.
3. The Run Indicator will be shown when in the Run mode and the Segments icon will also indicate that the function is in run mode.

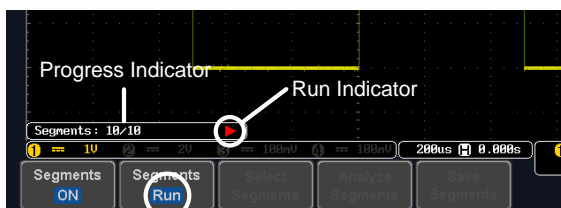

Segment (Run) icon

4. When the scope has finished acquiring segments, press *Segments Run* to toggle the mode to the *Segments Stop* mode.

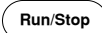

Alternatively, the *Run/Stop* key can be pressed. 

5. The Stop Indicator will be shown when in the Stop mode.

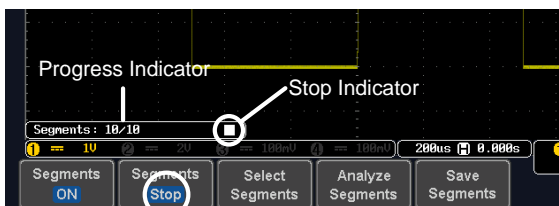

Segment (Stop) icon

The scope is now ready to navigate or analyze the acquired segments.

- Rerun Segmented Acquisition
1. To rerun the segments, press the *Segments Stop* key to toggle the mode back to the *Segments Run* mode.

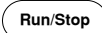

Alternatively, press the *Run/Stop* key again. 

2. Repeat steps 3 and 4 in the section above when the segmented acquisition has completed.

Navigate Segmented Memory

Background After the segmented memory acquisitions have been captured you can navigate through each segment one at a time.

Operation

1. Press *Select Segments* from the bottom menu. This key will be available in the Stop mode.

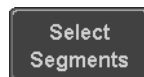

2. To navigate to the segment of interest, press *Current Seg* from the side menu and use the Variable knob to scroll to the segment of interest.

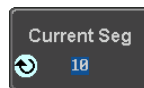

Alternatively, the *Set to Minimum* and *Set to Maximum* keys can be used to jump to the first and last segment respectively.

3. The position in time of the selected segment relative to the time of the first segment is shown in the *Segments Time* key.

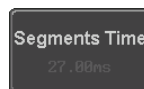

Play Through Each Segment

Background When all the segments have been acquired, the play/pause key can be used to play back through each segment.

Operation

1. Make sure the scope is in *Segments Stop* mode. See page 89 for details.

2. Press the *Play/Pause* key to run through the acquired segments in numerical order.



- Press the Play/Pause key again to pause the playback.
- When the scope has played through to the last segment, pressing the Play/Pause key again will play through each segment again in reverse order.

Segment Measurement

Background	The Segmented memory function can be used in conjunction with the automatic measurements in the Measurement menu.	
Modes	Segments Measure	This function will either perform statistics calculations on the segments or tabulate a list of the measurement results.
	Segments Info	Provides configuration information common for all the acquired memory segments.

Automatic Measurement

Background	The Segments Measure function allows you to view automatic measurements for the segments in statistical bins or as a list displaying the result of each automatic measurement.	
	Statistics	This function will bin the measurement results of a single automatic measurement into a user-defined number of bins. This allows you to easily view statistics for a large number of segments. For example, the statistics function will display the number of results for each bin and the measurement range of each bin for the selected automatic measurement.

Measurement List Puts all the measurement results for a segment in a list. All the currently selected automatic measurement results are listed. A maximum of 8 automatic measurements can be used with this function.

Note To use automatic measurements with the segmented memory, automatic measurements must first be selected from the Measure menu before the segmented memory function is run.

Setup Press the *Measure* key and select any *single* source measurement from the *Add Measurement* menu.



See page 49 for details on how to add automatic measurements.

Operation 1. Press *Analyze Segments* from the Segments menu.

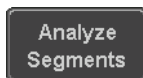

Note: This key will only be available in the Stop mode.

2. Press *Segments Measure*.



3. Select either the statistics or the measurement list from the side menu.



Statistics



List

- The statics table or measurement list appears on the display.

Note that the more segments that you have, the longer it will take to calculate the statics or list the measurement results.

- For statistic measurements, press *Plot Source* to choose which automatic measurement to use for the statistics calculations. The statistics for only one automatic measurement can be viewed at a time.
 

- For the measurement list, press *Source* and select the source channel for measurement.
 
- Range CH1 ~ CH4

Statistics Results This function will bin the measurement results of the selected automatic measurement into a user-defined number of bins.

- To select the number of bins for the statistics, press *Divided by* and select the number of bins with the Variable knob.
 
- Range 1~20 bins

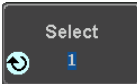
- Press *Select* and use the Variable knob to view the measurement results for each bin.
 

Example:
Statistics

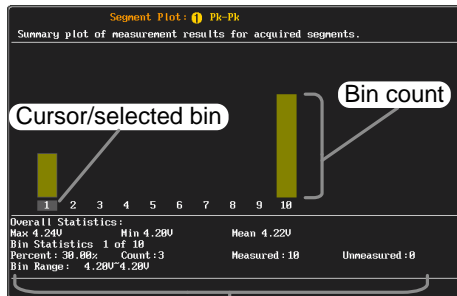

Statistics of currently selected bin

Measurement List

Puts all the measurement results for a segment in a list.

Setup

1. Press *Select* and use the variable knob to scroll through each segment.



Example:
Measurement List

Select cursor

Segment Summary
View and examine measurement results for acquired segments.

Seg.	Fall PreShoot (x)	Rise PreShoot (x)	Pk-Pk (U)
1	0.00	0.97	4.24
2	0.00	0.97	4.20
3	0.00	0.97	4.24
4	0.00	0.97	4.24
5	0.00	0.97	4.20
6	0.00	0.97	4.24
7	0.00	0.97	4.20
8	0.00	0.97	4.24
9	0.00	0.97	4.24
10	0.00	0.97	4.24

Measurement types

Measurement results

Segment Info

Operation

1. Press *Analyze Segments* from the bottom menu.

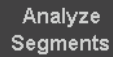
A rectangular button with a dark background and light text that reads "Analyze Segments".

Note: This key will only be available in the Stop mode.

2. Press *Segments Info*.

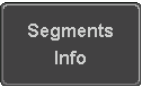
A rectangular button with a dark background and light text that reads "Segments Info".

3. A table showing all general setting information for the segmented memory acquisitions is shown on the display.

Info: Sample rate, Record length,
 Horizontal, Vertical

DSO Segmented Info.

```
Samplerate: 1GSa/s  
Record Length: 1000 points  
Horizontal: 0.000s @ 200ns/div  
Vertical: 80.000mV @ 1V/div
```

Display

The Display menu defines how the waveforms and parameters appear on the main LCD display.

Display Waveform as Dots or Vectors

Background When the waveform is displayed on the screen, it can be displayed as dots or vectors.

Panel Operation 1. Press the *Display* menu key.

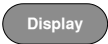

2. Press *Dot / Vector* to toggle between Dot and Vector mode.



Range	Dots	Only the sampled dots are displayed.
	Vectors	Both the sampled dots and the connecting line are displayed.

Example:

Vectors



Dots



Set the Level of Persistence

Background The persistence function allows the GDS-2000E to mimic the trace of a traditional analog oscilloscope. A waveform trace can be configured to “persist” for a designated amount of time.

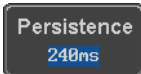
Panel Operation

1. Press the *Display* menu key. 
2. To set the persistence time, press the *Persistence* menu button on the bottom bezel. 
3. Use the Variable knob to select a persistence time. 

Time 16ms, 30ms, 60ms, 120ms, 240ms, 0.5s, 1s, 2s, ~4s, Infinite, Off

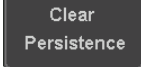
Clear To clear persistence, press *Clear Persistence*. 

Set the Intensity Level

Background The intensity level of a signal can also be set to mimic the intensity of an analog oscilloscope by setting the digital intensity level.

Panel Operation

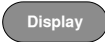
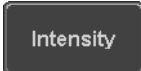
1. Press the *Display* menu key. 
2. Press *Intensity* from the bottom menu. 

Waveform
Intensity

3. To set the waveform intensity, press *Waveform Intensity* and edit the intensity.

Range 0~100%

Example

Waveform Intensity 50%

Waveform Intensity 100%

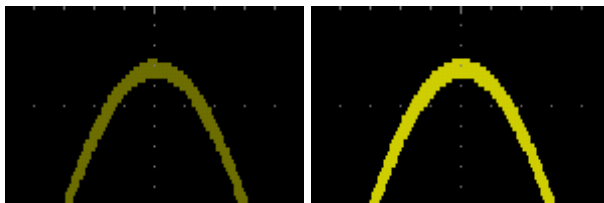

Graticule
Intensity

4. To set the graticule intensity, press *Graticule Intensity* from the side menu and edit the intensity value.

Range 10~100%

Example

Graticule Intensity 100%

Graticule Intensity 10%

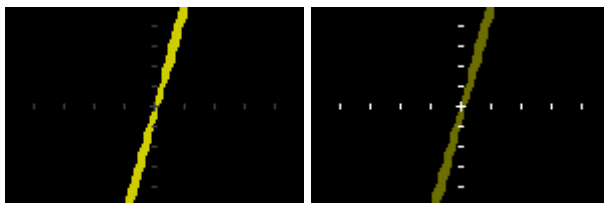

Backlight
Intensity

5. To set the LCD backlight intensity, press *Backlight Intensity* from the side menu and edit the intensity value.

Range 2~100%

- Backlight Auto-Dim
6. To automatically dim the backlight after a set duration, set *Backlight Auto-Dim* to On and then set *Time* to the appropriate time.

After the set amount of time with no panel activity, the screen will dim until a panel key is pressed again. This function will prolong the life of the LCD display.

Range 1~180 min

Select Display Graticule

Panel Operation 1. Press the *Display* menu key.



2. Press *Graticule* from the bottom menu.



3. From the side menu choose the graticule display type.



Full: Shows the full grid; X and Y axis for each division.



Grid: Show the full grid without the X and Y axis.







Cross Hair: Shows only the center X and Y frame.



Frame: Shows only the outer frame.

Freeze the Waveform (Run/Stop)

For more details about Run/Stop mode, see page 41.

- Panel Operation
1. Press the *Run/Stop* key. The *Run/Stop* key turns red and waveform acquisition is paused.
  → 
 2. The waveform and the trigger freezes. The trigger indicator on the top right of the display shows Stop.
 
 3. To unfreeze the waveform, press the *Run/Stop* key again. The Run/Stop key turns green again and acquisition resumes.
  → 

Turn Off Menu

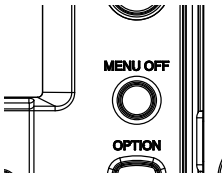
- Panel Operation
1. Press the *Menu Off* key below the side menu keys to reduce a menu. The menu key needs to be pressed each time to reduce one menu.
 

See page 31 for more information.

Horizontal View

This section describes how to set the horizontal scale, position, and waveform display mode.

Move Waveform Position Horizontally

Panel Operation The horizontal position knob moves the waveform left/right.

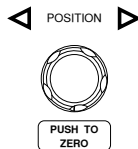

As the waveform moves, a position indicator on the top of the display indicates the horizontal position of the waveform in memory.



Reset Horizontal Position 1. To reset the horizontal position, press the Acquire key and then press *Reset H Position to 0s* from the bottom menu.



Alternatively, pushing the horizontal position knob will also reset the position to zero.

Run Mode In Run mode, the memory bar keeps its relative position in the memory since the entire memory is continuously captured and updated.

Select Horizontal Scale

Select Horizontal Scale To select the timebase (time/div), turn the horizontal Scale knob; left (slow) or right (fast).



Range 1ns/div ~ 100s/div, 1-2-5 increment

The timebase indicator updates as the horizontal scale is adjusted.

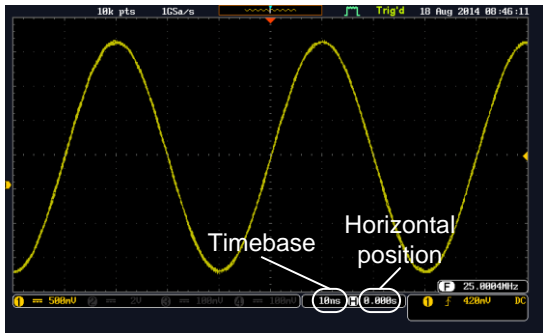

Run Mode In Run mode, the memory bar and waveform size keep their proportion. When the timebase becomes slower, roll mode is activated (if the trigger is set to Auto).

Stop Mode In Stop mode, the waveform size changes according to the scale.

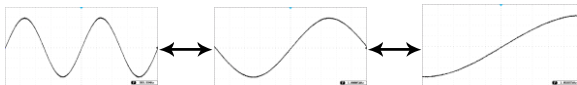

Select Waveform Update Mode

Background	The display update mode is switched automatically or manually according to the timebase and trigger.
Normal	<p>Updates the whole displayed waveform at once. Automatically selected when the timebase (sampling rate) is fast.</p> <p>Timebase $\leq 50\text{ms/div}$</p> <p>Trigger all modes</p>
Roll Mode	<p>Roll Updates and moves the waveform gradually from the right side of the display to the left. Automatically selected when the timebase (sampling rate) is slow.</p> <p>Timebase $\geq 100\text{ms/div}$</p> <p>Trigger all modes</p>



Select Roll Mode Manually 1. Press the *Trigger Menu* key.



2. Press *Mode* from the bottom menu and select *Auto (Untriggered Roll)* from the side menu.



Zoom Waveform Horizontally

Background When in Zoom mode, the screen is split into 2 sections. The top of the display shows the full record length, while the bottom of the screen shows the normal view.

Panel Operation 1. Press the *Zoom* key.



2. The Zoom mode screen appears.

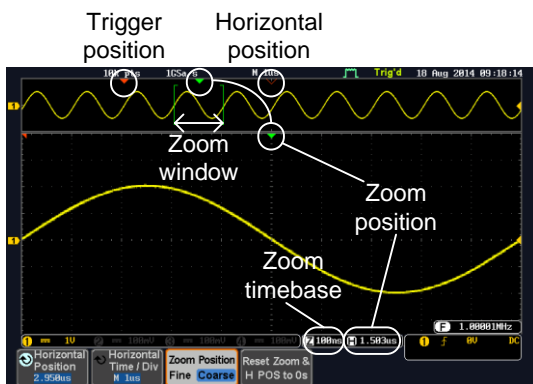

Horizontal Navigation

To scroll the waveform left or right, press *Horizontal Position* and use the *Variable Position* knob.



The horizontal position will be shown on the *Horizontal Position* icon.

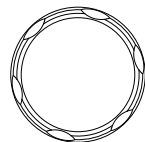

Horizontal Scale To change the horizontal scale, press *Horizontal Time/Div* and use the *Variable Position* knob.



The scale will be shown on the *Horizontal Time/Div* icon.

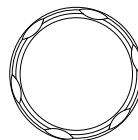

Zoom To increase the zoom range, use the horizontal *Scale* knob.

SCALE

The zoom time base (Z) at the bottom of the screen will change accordingly.

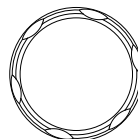

Move the Zoom Window Use the *Horizontal Position* knob to pan the zoom window horizontally.



To reset the zoom position, press the *Horizontal Position* knob.



The position of the zoom window, relative to the horizontal position is shown at the bottom of the screen next to the Zoom timebase.



Scroll Sensitivity To alter the scrolling sensitivity of the zoom window, press the *Zoom Position* key to toggle the scrolling sensitivity.

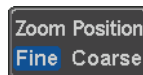

Sensitivity Fine, Coarse

Reset the Zoom & Horizontal Position To reset both the zoom and horizontal position, press *Reset Zoom & H POS to 0s*.

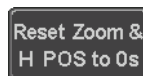

Exit

To go back to the original view, press
the *Zoom* key again.

A rounded rectangular button with a thin border and the word "Zoom" centered inside.

Play/Pause

Background The Play/Pause key can be used to play through signals in the Zoom mode.

Note If the Segmented memory function is turned on, pressing the play pause key will play through memory segments. See page 91 for information.

Panel Operation 1. Press the *Play/Pause* menu key.



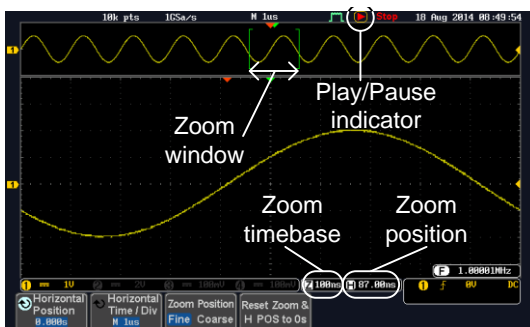

2. The scope will go into the Zoom Play mode and begin to scroll through the acquisition (from left to right).

The full-record length waveform will be shown at the top and the zoomed section will be shown at the bottom. The Play/Pause indicator shows the play status.

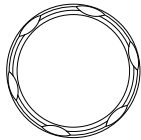

Zoom To increase the zoom range, use the horizontal *Scale* knob.

The zoom time base (Z) at the bottom of the screen will change accordingly.

Scroll Speed To alter the scrolling speed of the zoom window, press the *Zoom Position* key to toggle the scrolling speed.



Sensitivity Fine, Coarse

Alternatively, use the horizontal position knob to control the scroll speed.

- Turning the Horizontal knob determines the speed and direction of the scrolling.

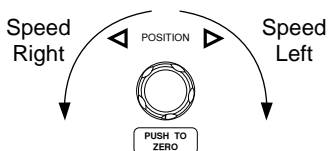

Reset the Zoom Position To reset both the zoom position and horizontal position, press *Reset Zoom & H POS to 0s*.

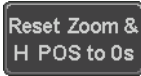

Pause Press the *Play/Pause* key to pause or resume playing the waveform.



Reverse Direction Press the *Play/Pause* key when at the end of the record length to play back through the waveform in reverse.



Exit

To exit, press the Zoom key.



Vertical View (Channel)

This section describes how to set the vertical scale, position, and coupling mode.

Move Waveform Position Vertically

Panel Operation





1. To move the waveform up or down, turn the *vertical position* knob for each channel.

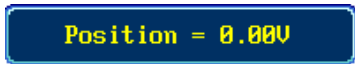

2. As the waveform moves, the vertical position of the cursor appears at the bottom half of the display.



View or Set the Vertical Position

1. Press a channel key. The vertical position is shown in the  *Position* /  *Set to 0* soft key.
2. To change the position, press  *Position* /  *Set to 0* to reset the vertical position or turn the *vertical position* knob to the desired level.



Run/Stop Mode

The waveform can be moved vertically in both Run and Stop mode.

Select Vertical Scale

Panel Operation To change the vertical scale, turn the vertical SCALE knob; left (down) or right (up).

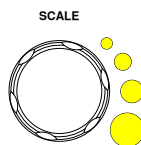

The vertical scale indicator on the bottom left of the display changes accordingly for the specific channel.

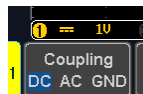

Range 1mV/div ~ 10V/div. 1-2-5 increments

Stop Mode In Stop mode, the vertical scale setting can be changed.

Select Coupling Mode

Panel Operation 1. Press a *channel* key.



2. Press *Coupling* repeatedly to toggle the coupling mode for the chosen channel.



Range

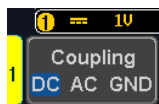

DC coupling mode. The whole portion (AC and DC) of the signal appears on the display.

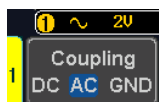

AC coupling mode. Only the AC portion of the signal appears on the display. This mode is useful for observing AC waveforms mixed with DC signals.

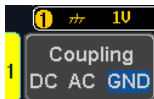

Ground coupling mode. The display shows only the zero voltage level as a horizontal line.

Example

Observing the AC portion of the waveform using AC coupling

DC coupling

AC coupling



Input Impedance

Background

The input impedance of the GDS-2000E is fixed at 1MΩ. The impedance is displayed in the channel menu.

View Impedance

1. Press the *Channel* key.

CH1

2. The impedance is displayed in the bottom menu.

Impedance
1MΩ

Invert Waveform Vertically

Panel Operation

1. Press the *Channel* key.

CH1

2. Press *Invert* to toggle Invert On or Off.

Invert
On Off

Limit Bandwidth

Background Bandwidth limitation puts the input signal into a selected bandwidth filter.

This function is useful for cutting out high frequency noise to see a clear waveform shape.

The bandwidth filters available are dependent on the bandwidth of the oscilloscope model.

Panel Operation 1. Press the *Channel* key.



2. Press *Bandwidth* from the bottom menu.



3. Choose a bandwidth* from the side menu.
*Depending on the bandwidth of the oscilloscope.

Range 70MHz models: Full, 20MHz
 100MHz models: Full, 20MHz
 200MHz models: Full, 20MHz,
 100MHz

Example

BW Full

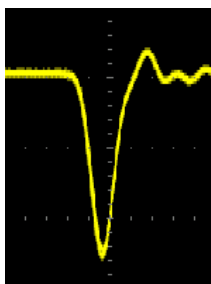

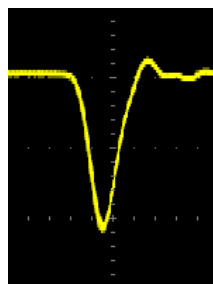

BW Limit 20MHz



Expand by Ground/Center

Background When the voltage scale is changed, the Expand function designates whether the signal expands from the center of the screen or from the signal ground level. Expand by center can be used to easily see if a signal has a voltage bias. Expand by ground is the default setting.

Panel Operation

1. Press a *channel* key. 
2. Press *Expand* repeatedly to toggle between expand *By Ground* and *Center*. 

Range By Ground, By Center

Example If the vertical scale is changed when the Expand function is set to ground, the signal will expand from the ground level*. The ground level does not change when the vertical scale is changed.

If the vertical scale is changed when the Expand function is set to center, the signal will expand from the center of the screen. The ground level will suit to match the signal position.

*Or from the upper or lower edge of the screen if the ground level is off-screen.

Expand by Ground

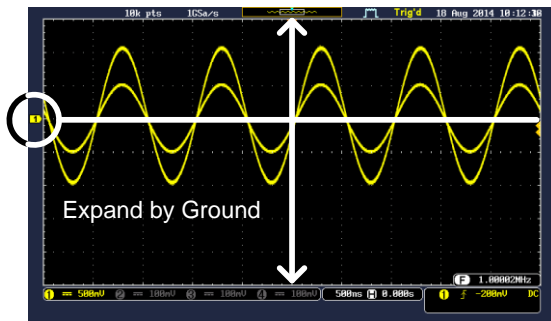

Expand by Center

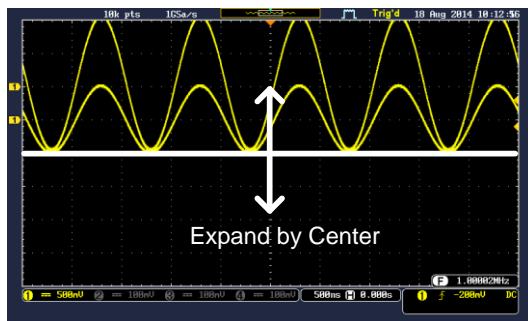

Select Probe Type

Background A signal probe can be set to voltage or current.

Panel Operation 1. Press the *Channel* key.



2. Press *Probe* from the bottom menu.

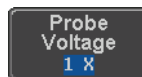



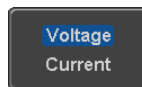

3. Press the *Voltage/Current* soft-key to toggle between voltage and current.



Select Probe Attenuation Level

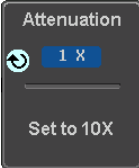

Background An oscilloscope probe has an attenuation switch to lower the original DUT signal level to the oscilloscope input range, if necessary. The probe attenuation selection adjusts the vertical scale so that the voltage level on the display reflects the real value on a DUT.

- Panel Operation**
1. Press the *Channel* key. 
 2. Press *Probe* from the bottom menu. 
 3. Press *Attenuation* on the side menu and use the Variable knob to set the attenuation. 
 Alternatively, press *Set to 10X*. 
- Range 1mX ~1kX (1-2-5 step)

 **Note** The attenuation factor adds no influence on the real signal. It just changes the voltage/current scale on the display.

Set the Deskew

Background The deskew function is used to compensate for the propagation delay between the oscilloscope and the probe.

- Panel Operation**
1. Press one of the *Channel* keys. 
 2. Press *Probe* from the bottom menu. 

3. Press *Deskew* on the side menu and use the Variable knob to set the deskew time.



Alternatively, press *Set to 0s* to reset the deskew time.

Range -50ns~50ns, 10ps increments

4. Repeat the procedure for another channel if necessary.

Bus Key Configuration

The Bus key is used to configure the Serial bus inputs. The Bus menu also features event tables to track and save your bus data. The Bus key is used in conjunction with the Bus trigger (page 163) to decode serial bus signals.

Bus Display

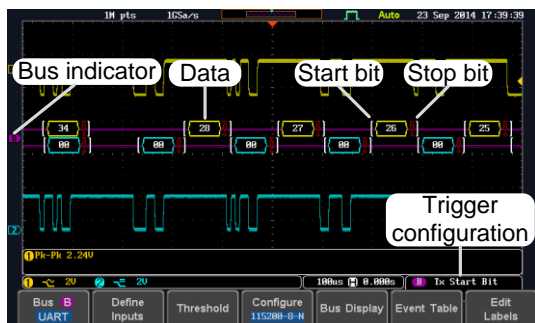

Start Bit/Start of Frame [The Start bit is shown as an open bracket.

Stop Bit/End of Frame] The Stop bit is shown as a closed bracket.

Data . F9 Data packets/frames can be shown in Hex or Binary. The color of the bus data indicates the type of data or the channel the data is coming from, depending on the bus type.

UART: Color of packet = Color of source channel.

I²C: Color packet = SDA source channel.

SPI: Color of packet = MOSI or MISO source channel.

- CAN: Purple = Error frame, Data length control (DLC), Overload.
 Yellow = Identifier.
 Cyan = Data.
 Orange = CRC.
 Red = Bit stuffing error
- LIN: Purple = Break, Sync and Checksum errors, Wakeup
 Yellow = Identifier, Parity
 Cyan = Data
 Red = Error type

Error Indicator/
Missing Ack

 If there is an error/missing acknowledge in decoding the serial data, a red error indicator will be shown.

Bus Indicator

The Bus indicator shows the bus position. The active bus is shown with a solid color. The Variable knob can be used to horizontally position the Bus indicator when it is active.

-  Active bus (solid indicator)
-  Activated bus (transparent indicator)

Trigger Configuration

Shows the bus trigger (B) and the *Trigger On* settings.

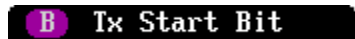

Serial Bus

The Serial Bus includes support for 5 common serial interfaces, SPI, UART, I²C, CAN and LIN. Each interface is fully configurable to accommodate variations in the basic protocols.

Each input can be displayed as binary, hexadecimal or ASCII. An event table can also be created to aid in debugging.

Serial Bus Overview

UART	<p>Universal Asynchronous Receiver Transmitter. The UART bus is able to accommodate a wide range of various common UART serial communications.</p> <p>The UART serial bus software is suitable for a number of RS-232 protocol variants.</p> <p>Inputs Tx, Rx</p> <p>Threshold Tx, Rx</p> <p>Configuration Baud rate, Parity, Packets, End of packets, Input polarity</p> <p>Trigger On Tx Start Bit, Rx Start Bit, Tx End of Packet, Rx End of Packet, Tx Data, Rx Data, Tx Parity Error, Rx Parity Error</p>
I ² C	<p>Inter Integrated Circuit is a two line serial data interface with a serial data line (SDA) and serial clock line (SCLK). The R/W bit can be configured.</p> <p>Inputs SCLK, SDA</p> <p>Threshold SCLK, SDA</p> <p>Configuration Addressing mode, Read/Write in address</p> <p>Trigger On Start, Repeat Start, Stop, Missing Ack, Address, Data, Address/Data</p>

SPI	<p>The SPI (Serial Interface Peripheral) bus is fully configurable to accommodate the wide variety of SPI interfaces. This bus is only available on 4 channel models.</p> <p>Inputs SCLK, SS, MOSI, MISO</p> <p>Threshold SCLK, SS, MOSI, MISO</p> <p>Configuration SCLK edge, SS logic level, Word size, Bit order</p> <p>Trigger On SS Active, MOSI, MISO, MOSI&MISO</p>
-----	---

CAN	<p>The CAN (Controller Area Network) bus is a 2-wire, message-based protocol.</p> <p>Inputs CAN Input</p> <p>Threshold CAN Input</p> <p>Configuration Signal Type, Bit Rate</p> <p>Trigger On Start of Frame, Type of Frame, Identifier, Data, Id & Data, End of Frame, Missing Ack, Bit Stuffing Err.</p>
-----	---

LIN	<p>The LIN (Local Interconnect Network) bus is used to decode a wide range of common LIN configurations.</p> <p>Inputs LIN Input</p> <p>Threshold LIN Input</p> <p>Configuration Bit Rate, LIN Standard, Include Parity Bits with Id</p> <p>Trigger On Sync, Identifier, Data, Id & Data, Wakeup Frame, Sleep Frame, Error</p>
-----	---

UART Serial Bus Configuration

The UART bus menu is designed to decode RS-232 and other common RS-232 variants such as RS-422, RS-485. The software configuration is also flexible enough to decode the many proprietary protocols based on RS-232.

Background

Basic RS-232 protocol uses single-ended data transmissions. The signal voltage levels can be high ($\pm 15V$) and employ active low signaling.

High speed variants of RS-232, such as RS-422 and RS-485 use differential signaling and commonly employ low voltage differential signals with active high signaling.

Universal Asynchronous Receiver/Transmitter (UART) or RS-232 driver/receiver ICs commonly used for embedded applications typically use active high signaling with standard IC signal levels.

Operation

1. Connect each of the bus signals (T_x , R_x) to one of the oscilloscope channels. Connect the ground potential of the bus to one of the probes' ground clip.

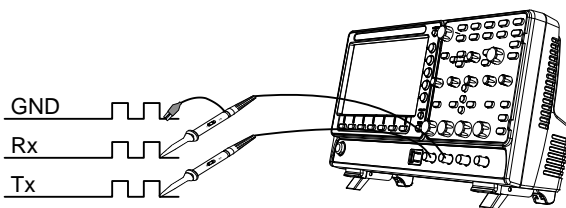

2. Press the *BUS* key.

BUS



3. Press *Bus* from the bottom menu and choose the *UART* serial bus on the side menu.



Define Inputs

4. Press *Define Inputs* from the bottom menu.

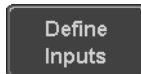

5. From the side menu choose the *Tx Input* and the *Rx Input* source and the signal polarity.

Tx OFF, CH1 ~ CH4

Rx OFF, CH1 ~ CH4

Polarity Normal (High = 0), Inverted (High = 1)

Configuration

The Configure key sets the baud rate, number of data bits and parity.

6. Press *Configure* from the bottom menu.

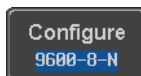

7. From the side menu select the *Baud rate*, *Data bits*, *Parity*, *Packets* and *End of Packet bits*.

Baud Rate 50, 75, 110, 134, 150, 300, 600, 1200, 1800, 2000, 2400, 3600, 4800, 7200, 9600, 14400, 15200, 19200, 28800, 31250, 38400, 56000, 57600, 76800, 115200, 128000, 230400, 460800, 921600, 1382400, 1843200, 2764800

Data Bits 8 (fixed)

Parity Odd, Even, None

Packets On, Off

End of Packet (Hex) 00(NUL), 0A(LF), 0D(CR), 20(SP), FF

I²C Serial Bus Interface

The I²C bus is a 2 wire interface with a serial data line (SDA) and serial clock line (SCLK). The I²C protocol supports 7 or 10 bit addressing and multiple masters. The scope will trigger on any of the following conditions: a start/stop condition, a restart, a missing acknowledge message, Address, Data or Address&Data frames. The I²C trigger can be configured for 7 or 10 bit addressing with the option to ignore the R/W bit as well as triggering on a data value or a specific address and direction (read or write or both).

- Panel operation
1. Connect each of the bus signals (*SCLK*, *SDA*) to one of the oscilloscope channels. Connect the ground potential to one of the probes' ground clip.

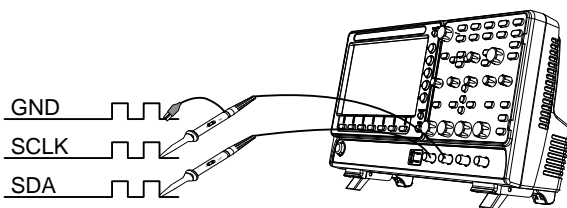

2. Press the *Bus* key.



3. Press *Bus* from the bottom menu and choose *I²C* from the side menu.

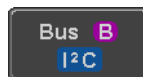

- Define Inputs
4. Press *Define Inputs* from the bottom menu.

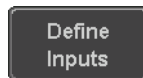

5. From the side menu choose the *SCLK* input and the *SDA* Input.

SCLK	CH1 ~ CH4
SDA	CH1 ~ CH4

Include R/W in address

To configure whether you want the R/W bit to be included in the address, press *Include R/W in address* and set to Yes or No in the side menu.

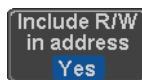

R/W Bit Yes, No

SPI Serial Bus Interface

The serial peripheral interface (SPI) is a full duplex 4 wire synchronous serial interface. The 4 signals lines: Serial clock line (SCLK), slave select (SS), Master output/slave input (MOSI, or SIMO) and the Master input/slave output (MISO, or SOMI). The word size is configurable from 4 to 32 bits. The SPI triggers on the data pattern at the start of each framing period. Note: The SPI bus is only available for 4 channel models.

- Panel operation
1. Connect each of the bus signals (*SCLK*, *SS*, *MOSI*, *MISO*) to one of the channel inputs. Connect the ground potential of the bus to one of the probes' ground clip.

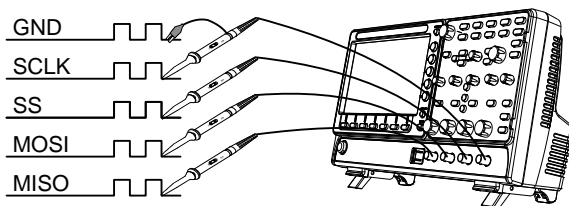



2. Press the *Bus* key.

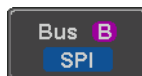

3. Press *Bus* from the bottom menu and choose the *SPI* serial bus.

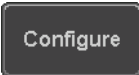

Define Inputs	<p>4. Press <i>Define Inputs</i> from the lower menu.</p> <p style="text-align: right;"></p> <p>5. From the side menu choose the <i>SCLK</i>, <i>SS</i>, <i>MOSI</i> and <i>MISO</i> inputs.</p> <p style="margin-left: 40px;"><i>SCLK</i> CH1 ~ CH4</p> <p style="margin-left: 40px;"><i>SS</i> CH1 ~ CH4</p> <p style="margin-left: 40px;"><i>MOSI</i> OFF, CH1 ~ CH4</p> <p style="margin-left: 40px;"><i>MISO</i> OFF, CH1 ~ CH4</p> <hr/>
Configuration	<p>The <i>Configure</i> menu sets the data line logic level, <i>SCLK</i> edge polarity, word size and bit order.</p> <p>6. Press <i>Configure</i> from the bottom menu.</p> <p style="text-align: right;"></p> <p>7. From the side menu select <i>SCLK</i> edge, <i>SS</i> logic level, word Size and Bit order.</p> <p style="margin-left: 40px;"><i>SCLK</i> rising edge , falling edge </p> <p style="margin-left: 40px;"><i>SS</i> Active High, Active Low</p> <p style="margin-left: 40px;">Word Size 4 ~ 32 bits</p> <p style="margin-left: 40px;">Bit Order MS First, LS First</p> <hr/>

CAN Serial Bus Interface

The controller area network (CAN) bus is a half duplex 2 wire synchronous serial interface. The CAN bus is a multi-master communication system that relies on arbitration to solve contention issues. The GDS-2000E supports both CAN 2.0A and 2.0B. The CAN bus uses two wires, CAN-High and CAN-Low. These wires are voltage inverted, and as such, the GDS-2000E only needs one wire, CAN-High or CAN-Low for decoding.

- Panel operation
1. Connect the bus signal (*CAN Input*) to one of the channel inputs. Connect the ground potential of the bus to the probe's ground clip.

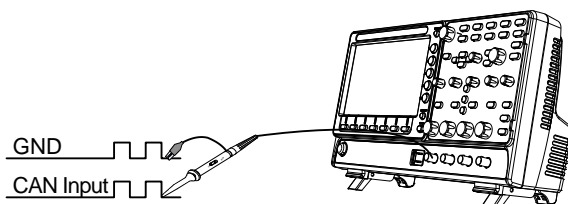

2. Press the *Bus* key.



3. Press *Bus* from the bottom menu and choose the *CAN* serial bus.

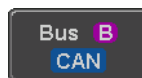

Define Inputs

4. Press *Define Inputs* from the lower menu.

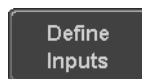

5. From the side menu choose the *CAN Input* inputs and the signal type.

CAN Input CH1 ~ CH4

Signal CAN_H, CAN_L, Tx, Rx.

Type



Note

The *Sample Point* soft-key indicates the sampling position of each bit. This parameter is fixed.

Bit Rate

The *Bit Rate* menu sets the bit rate of the bus. The bit rate is usually tied to the bus length.

6. Press *Bit Rate* from the bottom menu and set the bit rate.



Bit Rate 10kbps, 20kbps, 50kbps, 125kbps,
250kbps, 500kbps, 800kbps, 1Mbps

LIN Serial Bus Interface

The local interconnect network (LIN) bus is a single wire interface.

Panel operation

1. Connect the bus signal (*LIN Input*) to one of the channel inputs. Connect the ground potential of the bus to the probe's ground clip.

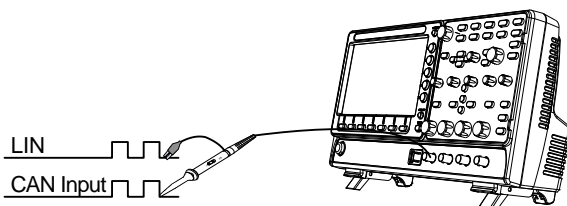

2. Press the *Bus* key.



3. Press *Bus* from the bottom menu and choose the *LIN* serial bus.



Define Inputs

4. Press *Define Inputs* from the lower menu.

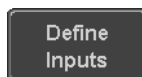

- From the side menu choose the LIN input and the polarity of the bus.

LIN Input CH1 ~ CH4

Polarity Normal (High = 1),
Inverted(High = 0)



Note

The *Sample Point* soft-key indicates the sampling position of each bit. This parameter is fixed.

Configuration

The *Configure* menu sets the bit rate, the LIN standard and the parity options for the Id frame.

- Press *Configure* from the bottom menu.

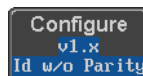

- From the side menu select configuration items.

Bit Rate 1.2kbps, 2.4kbps, 4.8kbps,
9.6kbps, 10.417kbps, 19.2kbps

LIN Standard V1.x, V2.x, Both

Include Parity On, Off
Bits with Id

Bus Encoding

Background

The bus that is displayed on the screen or in the event tables can be set to either hex or binary formats.

Operation

Press *Bus Display* from the Bus menu and choose either Hex or Binary from the side menu.

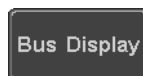

Threshold Configuration

Background The threshold levels for the Serial buses can be set to either a user-defined threshold level or to pre-set threshold.

Set the Threshold 1. Press *Threshold* from the bottom menu.

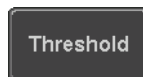

2. Press *Select* from the side menu and choose a one of the serial bus lines.



UART	Tx, Rx
I ² C	SCLK, SDA
SPI	SCLK, SS, MOSI, MOSI
CAN	CAN_H, CAN_L, Tx, Rx
LIN	LIN Input

3. Press *Choose Preset* to select a pre-set logic threshold.

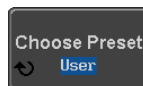

Logic Type	Threshold
TTL	1.4V
5.0V CMOS	2.5V
3.3V CMOS	1.65V
2.5V CMOS	1.25V
ECL	-1.3V
PECL	3.7V
0V	0V

4. Press *Threshold* to set a user defined threshold for the currently selected group. The threshold level depends on vertical scale.

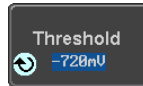

Scale	Range	Scale	Range
10V/Div	±290V	50mV/Div	±5.2V
5V/Div	±270V	20mV/Div	±580mV
2V/Div	±33V	10mV/Div	±540mV
1V/Div	±29V	5mV/Div	±520mV
500mV/Div	±27V	2mV/Div	±508mV
200mV/Div	±5.8V	1mV/Div	±504mV
100mV/Div	±5.4V		

Serial Bus Event Tables

Background The serial bus event tables list when each data event on the bus occurred. The data is displayed as either hex or binary, depending on the bus display settings.

Event tables can be saved to disk in a CSV format. The files will be named "Event_TableXXXX.CSV", where XXXX is a number from 0000 to 9999. See page 139 for details.

Operation

1. Press *Event Table* from the bottom menu.

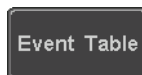

2. Press *Event Table* from the side menu to turn the event table on or off.

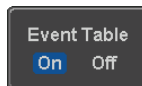

Event On, Off

Use the Variable knob to scroll through the event table.

Data Detail (I²C only)

3. To view the data at a particular address in more detail, turn *Data Detail* On. This is only available for the I²C bus.

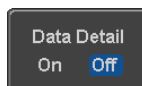

Detail On, Off

Use the Variable knob to scroll through the Data Detail event table.

- Save Event Table 4. To save the event table, press *Save Event Table*. The Event table will be saved to the current file path in a CSV format. See page 139 for details.

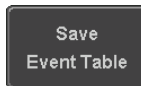

Use the variable knob to scroll through the event table.

Example:
UART Event table

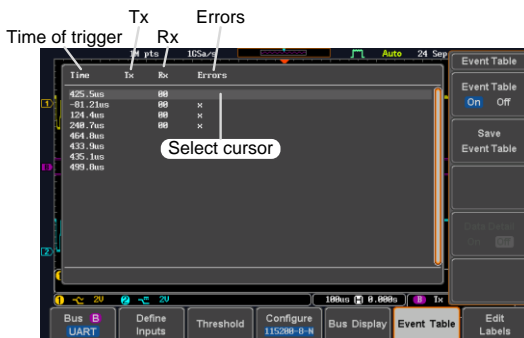

Example:
I²C Event table

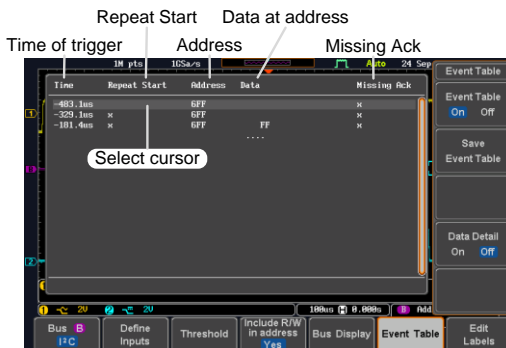

Example:
LIN Event table

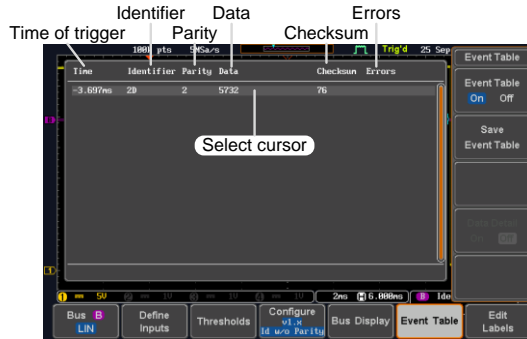

Event Tables Format

Each bus type (UART, I²C, SPI, CAN, LIN) can have an event table saved containing each bus event as a .CSV file. For serial buses, an event is defined as the data on the bus when a Stop or End of Packet (UART) is encountered. The data associated with each event and the time of each event is recorded.

File Type Each event table is saved as Event_TableXXXX.CSV into the designated file path. Each event table is numbered sequentially from 0000 to 9999. For example the first event table will be saved as Event_Table0000.CSV, the second as Event_Table0001.CSV, and so on.

Event Table Data Each event table saves a timestamp of each event relative to the trigger as well as the data in each frame/packet at the time of an event. The frame/packet data is saved in HEX format.

The table below lists in order the data saved for each event table.

UART	Time, Tx frame data, Rx frame data, Errors.
I ² C	Time, Repeat Start, Address, Data, Missing Ack.
SPI	Time, MISO frame data, MOSI frame data.
CAN	Time, Identifier, DLC, Data, CRC, Missing Ack.
LIN	Time, Identifier, Parity, Data, Checksum, Errors.

Example Below shows the data associated with an SPI event table in a spreadsheet.

Time	MOSI	MISO
-11.60us	0D87	0D87
-10.16us	06C0	06C0
-8.720us	8343	343
-7.282us	243	243
-5.840us	0C88	0C88

Adding a Label to the Serial Bus

Background A Label can be added to the serial buses. This label will appear next to the bus indicator on the left hand-side of the display.

Panel Operation 1. To add a label to the bus, press *Edit Labels* from the Bus menu. 

2. To choose a preset label, Press *User Preset* from the side menu and choose a label. 

Labels ACK, AD0, ADDR, ANALOG, BIT, CAS, CLK, CLOCK, CLR, COUNT, DATA, DTACK, ENABLE, HALT, INT, IN, IRQ, LATCH, LOAD, NMI

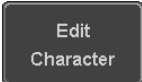
Edit Label 3. Press *Edit Character* to edit the current label. 

- The Edit Label window appears.

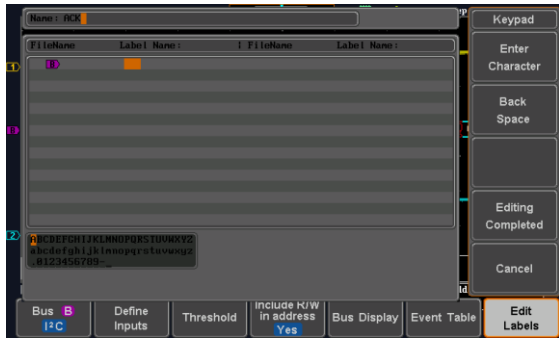

- Use the Variable knob to highlight a character.



Press *Enter Character* to select a number or letter.

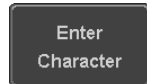

Press *Back Space* to delete a character.



Press *Editing Completed* to create the new label and return to the previous menu.

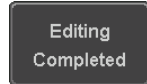

Note: this key must be pressed to save the label, even for the preset labels.

Press *Cancel* to cancel the editing and return to the Edit Label menu.

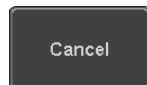

- The label will appear next to the bus indicator.

Below, the label “ACK” was created for the bus.



Remove Label Press *Label Display* to toggle the label on or off.

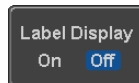

Using Cursors with the Serial Bus

Background The cursors can be used to read bus values at any position.



Note

Ensure that one of the serial buses has been selected and is activated.

Panel Operation 1. Press the *Cursor* key. Horizontal cursors appear on the display.

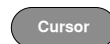

2. Press the *H Cursor* soft-key and select which cursor(s) you wish to position.

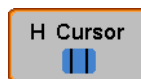

Range	Description
∷	Left cursor (1) movable, right cursor position fixed
∷	Right cursor (2) movable, left cursor position fixed
∷	Left and right cursor (1+2) movable together

3. The cursor position information appears on the top left hand side of the screen.

❶	-268us	Addr :0x6FF
❷	232us	Data :0xFF
	Δ500us	

Example: I²C cursors.

Cursor ❶ Hor. position, Bus value(s)

Cursor ❷ Hor. position, Bus value(s)

4. Use the *Variable knob* to move the movable cursor(s) left or right.

VARIABLE

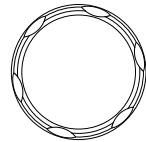

Trigger

The trigger configures the conditions for when the GDS-2000E captures a waveform.

Trigger Type Overview

Edge The edge trigger is the simplest trigger type. An edge trigger triggers when the signal crosses an amplitude threshold with either a positive or negative slope.

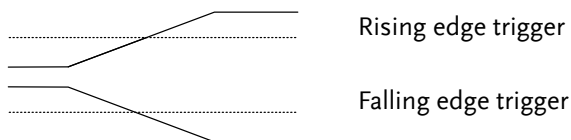

Delay The Delay trigger works in tandem with the edge trigger, by waiting for a specified time (duration) or number of events before the delay trigger starts. This method allows pinpointing a location in a long series of trigger events.

Note: when using the delay trigger, the edge trigger source can be any one of the channel inputs, the EXT* input or the AC line. *EXT only available on 2 channel models.

Delay trigger example (by event)

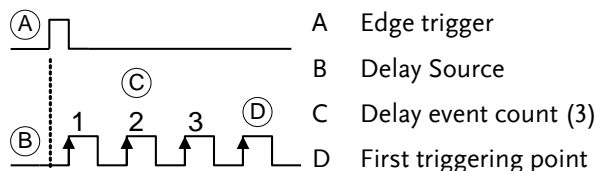

Delay trigger example (by time)

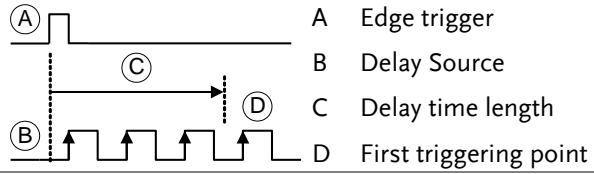

Pulse Width

Triggers when the pulse width of the signal is less than, equal, not equal or greater than a specified pulse width.

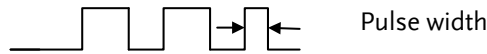

Video

Extracts a sync pulse from a video format signal, and triggers on a specific line or field.

Pulse and Runt

Triggers on a "runt". A runt is a pulse that passes a specified threshold but fails to pass a second threshold. Both positive and negative runts can be detected.

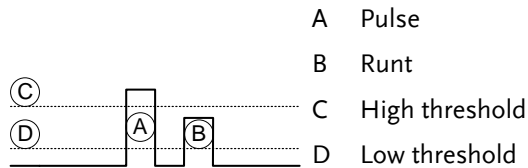

Rise and Fall (Slope)

Trigger on rising and or falling edges, below or over a specified rate. The threshold can also be specified.

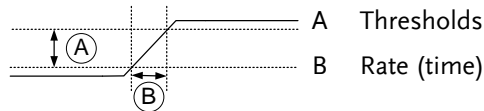

Timeout Triggers when the signal stays high, low or either for a designated amount of time. The trigger level determines when a signal is high or low.

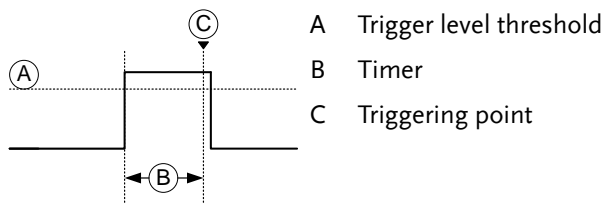



Bus Triggers on SPI, UART, I2C, CAN or LIN bus.



Trigger Parameter Overview





All the following parameters are common for all the trigger types unless stated otherwise.





Trigger Source	CH1 ~ 4	Channel 1 ~ 4 input signals	
	EXT	External trigger input signal	EXT TRIG
			
	AC Line	AC mains signal	
	Alternate	Alternate between channel sources for the trigger source.	
	EXT Probe	Probe trigger source. Set the probe as either current or voltage.	

Source Bus	UART	UART bus
	I ² C	Inter-Integrated Circuit
	SPI	Serial Peripheral Bus
	CAN	Controller Area Network bus

	LIN	Local Interconnect Network
Trigger Mode	Auto (un-triggered roll)	The GDS-2000E generates an internal trigger if there is no trigger event, to make sure waveforms are constantly updated regardless of trigger events. Select this mode especially when viewing rolling waveforms at slower timebases.
	Normal	The GDS-2000E acquires a waveform only when a trigger event occurs.
	Single	The GDS-2000E acquires a waveform once when a trigger event occurs, then stops acquiring. Press the Single key to acquire a waveform again. Single
Coupling (Edge, Delay, Timeout)	DC	DC coupling.
	AC	AC coupling. Blocks DC components from the trigger circuits.
	HF reject	High frequency filter above 70kHz
	LF reject	Low frequency filter below 70kHz
	Reject noise	DC coupling with low sensitivity to reject noise.
Slope (Edge, Delay, Rise & Fall)		Trigger on a rising edge.
		Trigger on a falling edge.
		Either. (either rising or falling edge) (Edge, Delay, Rise & Fall trigger type only)

Trigger Level (Edge, Delay)	Level	Adjusts the trigger manually using the Trigger LEVEL knob.	
	Set to TTL 1.4V	Sets the trigger level to 1.4V, suitable for triggering on TTL signals.	
	Set to ECL - 1.3V	Sets the trigger to -1.3V. This is suitable for ECL circuits.	
	Set to 50%	Sets the trigger level to 50% of the waveform amplitude.	
Holdoff	Holdoff	Sets the holdoff time.	
	Set to Minimum	Set the holdoff time to the minimum.	
Delay (Delay)	Time	Sets the delay time (4ns ~ 10s) between the trigger event and the real trigger timing.	
	Event	Sets the number of events (1 ~ 65535) passed after the trigger event, until the real trigger timing.	
	Set to Minimum	Sets the source trigger to the minimum time.	
When (Pulse Width)	Sets the pulse width (4ns ~ 10s) and the triggering condition.		
	>	Longer than	= Equal to
	<	Shorter than	≠ Not equal to
Threshold (Pulse Width)	Sets the amplitude threshold level for the pulse widths.		
	Threshold	-XXV ~ +XXV, user-set level	

	Set to TTL	1.4V
	Set to ECL	-1.3V
	Set to 50%	Sets the threshold to 50%
Standard (Video)	NTSC	National Television System Committee
	PAL	Phase Alternate by Line
	SECAM	SEquential Couleur A Memoire
Polarity (Pulse Width, Video)		Positive polarity (triggered on the high to low transition)
		Negative polarity (triggered on the low to high transition)
Polarity (Pulse Runt)		Positive polarity (positive runt)
		Negative polarity (negative runt)
		Either (either negative or positive runt)
Trigger On (Video)	Selects the trigger point in the video signal.	
	Field	1 or 2 or all.
	Line	1~263 for NTSC 1~313 for PAL/SECAM
Trigger On (Bus)	Selects the conditions for the bus triggers.	
	UART Bus	Tx Start Bit, Rx Start Bit, Tx End of Packet, Rx End of Packet, Tx Data, Rx Data, Tx Parity Error, Rx Parity Error
	I ² C	Start, Repeat Start, Stop, Missing Ack, Address, Data, Address/Data
	SPI	SS Active, MOSI, MISO, MOSI&MISO
	CAN	Start of Frame, Type of Frame, Identifier, Data, Id & Data, End of Frame, Missing Ack, Bit Stuffing Err

	LIN	Sync, Identifier, Data, Id & Data, Wakeup Frame, Sleep Frame, Error
Threshold (Pulse Runt)		Sets the upper threshold limit.
		Sets the lower threshold limit.
Threshold (Rise & Fall)		High Sets the High threshold.
		Low Sets the Low threshold.
Trigger When (Timeout)	Stays High	Triggers when the input signal stays high for a designated amount of time.
	Stays Low	Triggers when the input signal stays low for a designated amount of time.
	Either	Triggers when the input signal stays high or low for a designated amount of time.
Timer (Timeout)	4nS~10.0S	Sets the amount of time that a signal must stay high or low for the timeout trigger.

Setup Holdoff Level

Background The holdoff function defines the waiting period before the GDS-2000E starts triggering again after a trigger point. The holdoff function ensures a stable display if there are a number of points in a periodic waveform that can be triggered. Holdoff applies to all the triggering types.

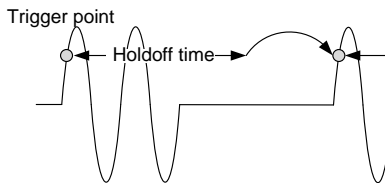

Panel Operation 1. Press the trigger *Menu* key.



2. To set the Holdoff time, press the *Holdoff* (or *Mode/Holdoff*) menu button on the bottom bezel.



3. Use the side menu to set the Holdoff time.

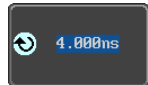

Range 4ns~10s

Pressing *Set to Minimum* sets the Holdoff time to the minimum, 4ns.





Note



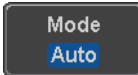

Note: The holdoff function is automatically disabled when the waveform update mode is in roll mode (page106).

Setup Trigger Mode

Background The trigger mode can be set to Normal or Auto (untriggered roll). The triggering mode applies to all the trigger types. See page 106.

- Panel Operation**
1. Press the Trigger menu key. 
 2. Press *Mode* from the bottom menu to change the triggering mode. 
 3. Use the side panel to select *Auto* or *Normal* triggering modes.
Range Auto, Normal

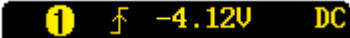
Using the Edge Trigger

- Panel Operation**
1. Press the trigger *Menu* key. 
 2. Press *Type* from the lower bezel menu. 
 3. Select *Edge* from the side menu. The edge trigger indicator appears at the bottom of the display. 

From left: trigger source, slope, trigger level, coupling
 4. Press *Source* to change the trigger source. 

5. Use the side menu to select the trigger source type.

Range Channel 1 ~ 4 (Alternate On/Off),
EXT (Ext Probe: Volt/Current,
Attenuation: 1mX~1kX, CH2
models only), AC Line

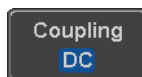
6. Press *Coupling* from the bottom bezel menu to select the trigger coupling or frequency filter settings.



Choose the coupling from the side menu.

Range DC, AC, HF Reject, LF Reject

7. Toggle *Noise Rejection* On or Off from the side menu.

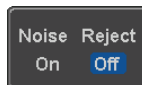

Range On, Off

8. From the bottom menu press *Slope* to toggle the slope type.



Range Rising edge, falling edge, either

9. To set the external trigger level, select *Level* from the bottom bezel menu (Not applicable for AC line source).



10. Set the external trigger level using the side menu.



Range 00.0V~ 5 screen divisions
Set to TTL 1.4V
Set to ECL -1.3V
Set to 50%

Using Advanced Delay Trigger

Panel Operation 1. Set the edge trigger source. This will set the initializing trigger for the delay source. Page 152

2. Press the trigger *Menu* key.



3. Press *Type* from the lower bezel menu.



4. Select *Delay* from the side menu. The delay trigger indicator appears at the bottom of the display.

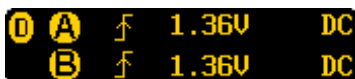

From left: Delay trigger indicator (D), edge trigger (A), edge slope, edge level, edge coupling, delay trigger (B), delay slope, delay trigger level, delay coupling.

5. To set the delay source, press *Source* and select a source from the side menu.

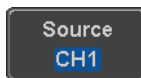

Source CH1 ~ CH4, AC Line, EXT*
*2 channel models only.

6. Press *Coupling* from the bottom bezel menu to select the trigger coupling or frequency filter settings.

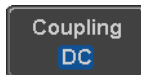

Choose the coupling from the side menu.

Range DC, AC, HF Reject, LF Reject

7. To set the delay press *Delay* from the bottom bezel.

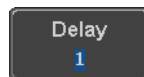

8. To Delay by Time (Duration), press *Time* from the side menu and set the delay time.

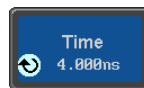

Range 4ns ~ 10s (by time)
Set to minimum

9. To Delay by Event, press *Event* from the side menu and set the number of events.



Range 1 ~ 65535 events
Set to Minimum

Using Pulse Width Trigger

- Panel Operation 1. Press the trigger *Menu* key.



2. Press the *Type* key from the lower bezel menu.



3. Select *Pulse Width* from the side menu. The pulse width trigger indicator appears at the bottom of the display.



From left: source, polarity, when, coupling

4. Press *Source* from the lower bezel.

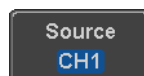

5. Use the side menu to select the pulse width trigger source.
 - Range Channel 1 ~ 4 (Alternate On/Off),
EXT (Ext Probe: Volt/Current,
Attenuation: 1mX~1kX), AC Line

6. Press *Polarity* to toggle the polarity type.

Polarity

 - Range Positive (high to low transition)
Negative (low to high transition)

7. Press *When* from the lower bezel.

When
 > 4.000ns

Then use the side menu to select the pulse width condition and width.

Condition > , < , = , ≠

Width 4ns ~ 10s







8. Press *Threshold* from the lower bezel to edit the pulse width threshold.

Threshold
 40mV

Use the side menu to set the threshold.

Range -XXV~XXV
 Set to TTL 1.4V
 Set to ECL -1.3V
 Set to 50%

Using Video Trigger

- Panel Operation
- Press the trigger *Menu* key. 
 - Press the *Type* key from the lower bezel menu. 
 - Select *Video* from the side menu. The video trigger indicator appears at the bottom of the display. 

 From left: source, video standard, field, line, coupling
 - Press *Source* from the lower bezel. 
 - Use the side menu to select the video trigger source.
 Range Channel 1 ~ 4
 - Press *Standard* on the bottom bezel. 
 Use the side menu to select the video standard.
 Range NTSC, PAL, SECAM, EDTV(480P, 576P), HDTV(720P, 1080i, 1080P)

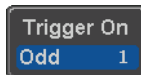
7. Press *Trigger On* to edit the video field and line.



Use the side menu to select the field and line.

Field 1, 2, All

Video line NTSC: 1 ~ 262 (Even), 1 ~ 263 (Odd)
 PAL/SECAM: 1 ~ 312 (Even),
 1 ~ 313 (Odd)
 EDTV: 1~525(480P), 1~625(576P)
 HDTV: 750(720P),
 odd:1~563,even:1~562(1080i),
 1~1125(1080P)

8. Press *Polarity* to toggle the polarity type.



Range positive, negative

Pulse Runt trigger

- Panel Operation 1. Press the trigger *Menu* key.



2. Press the *Type* key from the lower bezel menu.



3. Select *Others* → *Pulse Runt* from the side menu. The Pulse and Runt indicator appears at the bottom of the display.

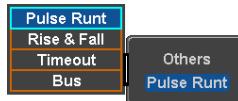

From left: polarity, source, high/low threshold, threshold level, coupling

4. Press *Source* from the lower menu.



Use the side menu to select a source.

Range Channel 1 ~ 4(Alternate On/Off)

5. Press *Polarity* to toggle the polarity.

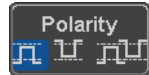

Range Rising edge, falling edge, either.

6. Press *When* from the lower menu.

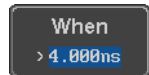

Then use the side menu to select the condition and width.

Condition > , < , = , ≠

Width 4ns ~ 10s

7. Press *Threshold* from the lower bezel to edit the threshold for the upper and lower threshold.



8. Use the side menu to set the upper threshold.



Range -XXV~XXV

9. Use the side menu to set the lower threshold.



Range -XXV~XXV

Using Rise and Fall Trigger

Panel Operation 1. Press the trigger *Menu* key.



2. Press the *Type* key from the lower bezel menu.



3. Select *Others* → *Rise and Fall* from the side menu. The Rise and Fall indicator appears at the bottom of the display.

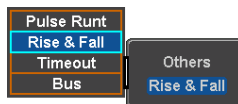

From left: slope, source, high/low threshold, threshold level, coupling

4. Press *Source* from the lower menu.



Use the side menu to select a source.

Range Channel 1 ~ 4(Alternate On/Off)

5. Press *Slope* from the bottom menu to toggle the slope.

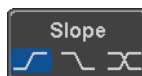

Range Rising edge, falling edge, either

6. Press *When* from the lower menu.

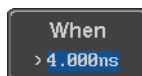

Then use the side menu to select the logic conditions and true or false status.

Condition > , < , = , ≠

Width 4ns ~ 10s

7. Press *Threshold* from the lower bezel to edit the High and Low threshold.



Range High: -XXV~XXV
Low: -XXV~XXV

Using the Timeout Trigger

- Panel Operation
1. Press the trigger *Menu* key.



2. Press the *Type* key from the lower bezel menu.



3. Select *Others* → *Timeout* from the side menu. The Timeout indicator appears at the bottom of the display.

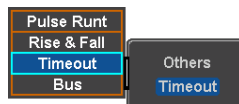

① Timeout 1.40V DC

From left: Source, Trigger type, threshold level, coupling

4. Press *Source* from the lower menu.



Use the side menu to select a source.

Range Channel 1 ~ 4, EXT (Ext Probe: Volt/Current, Attenuation: 1mX~1kX), AC Line

5. Press *Coupling* from the bottom bezel menu to select the trigger coupling or frequency filter settings.

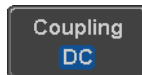

Choose the coupling from the side menu.

Range DC, AC, HF Reject, LF Reject

6. Toggle *Noise Rejection* On or Off from the Coupling side menu.

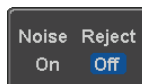

Range On, Off

7. Press *Trigger When* from the lower menu.



Then use the side menu to select trigger conditions.

Condition Stays High, Stays Low, Either

8. Press *Level* from the lower bezel to set the trigger level.

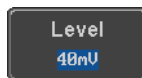

Range -XXV~XXV

Set to TTL 1.4V

Set to ECL -1.3V

Set to 50%

9. Press *Timer* from the lower bezel to set the timer time.

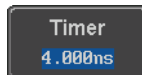

Range 4ns~10.0S

Using the Bus Trigger

Background The Bus trigger is used to trigger and decode UART, I2C, SPI, CAN and LIN serial bus signals.

UART BUS Trigger Settings

The UART bus trigger conditions can be set at any time after the bus settings have been set to *UART*.

Panel Operation 1. Set the Bus to UART in the bus menu. Page 125

2. Press the *Trigger Menu* key.



3. Press *Type* from the bottom menu.



4. Press *Others* from the side menu and select *Bus*.

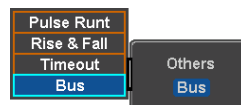

The Trigger on settings will be reflected on the Trigger Configuration icon.



From left: Bus trigger, Trigger source

5. Press *Trigger On* and select the triggering condition for the UART bus.

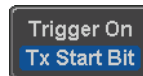

Trigger On Tx Start Bit, Rx Start Bit, Tx End of Packet, Rx End of Packet, Tx Data, Rx Data, Tx Parity Error, Rx Parity Error

Trigger On – Tx Data, Rx Data If Tx Data or Rx Data was configured for the Trigger On setting, then the number of bytes and data can also be configured.

6. Press *Data* from the bottom menu.

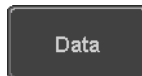

7. Press *Number of Bytes* from the side menu and choose the number of bytes for the data.

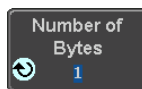

UART 1~10 Bytes

8. Press *Data* from the side menu to edit the triggering data.

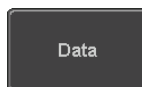

To edit the data, use the *Variable* knob to highlight a binary or hex digit and press *Select*. Use the *Variable* knob to choose a value for the digit and press *Select* to confirm.

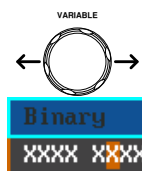

- Binary 0,1,X (don't care)
- Hex 0~F, X (don't care)
- ASCII ASCII characters for the equivalent Hex characters 00 to FF

I²C Bus Trigger Settings

The I²C bus trigger conditions can be set at any time after the bus settings has been set to I²C.

Panel Operation 1. Set the Bus to I²C in the bus menu. Page 127

2. Press the *Trigger Menu* key.



3. Press *Type* from the bottom menu.



4. Press *Others* from the side menu and select *Bus*.

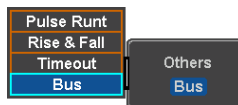

The Trigger on settings will be reflected on the Trigger Configuration icon.



From left: Bus trigger, Trigger source

5. Press *Trigger On* and select the triggering condition for the selected bus.



Trigger On Start, Repeat Start, Stop, Missing Ack, Address, Data, Address/Data

Trigger On – Data

If Data or Address/Data was configured for the Trigger On setting, then the number of bytes, data and addressing mode (I²C) can be configured.

6. Press *Data* from the bottom menu.



7. Press *Number of Bytes* from the side menu and choose the number of bytes for the data.

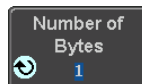

I²C 1~5 Bytes

8. Press *Addressing Mode* to toggle between 7 and 10 bit addressing modes.



9. Press *Data* from the side menu to edit the triggering data.

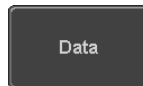

To edit the data, use the *Variable* knob to highlight a binary or hex digit and press *Select*. Use the *Variable* knob to choose a value for the digit and press *Select* to confirm.

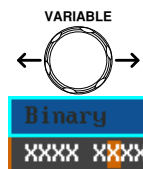

Binary 0,1,X (don't care)

Hex 0~F, X (don't care)

Trigger On -
Address

If Address or Address/Data was configured for the Trigger On setting, then the triggering address must be configured.

10. Press *Address* on the bottom menu.

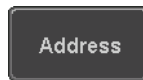

11. Press *Addressing Mode* to toggle between 7 and 10 bit addressing modes.



12. To choose a preset address as the default address, press *Choose Preset* and select a preset address.

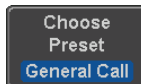

Address	Description
0000 000 0	General Call
0000 000 1	START Byte
0000 1XX X	Hs-mode
1010 XXX X	EEPROM
0000 001 X	CBUS

Press *Apply Preset* to set the default address to the preset.



Note

- Presets are not available for *Trigger On Address/Data*.

13. Press *Address* from the side menu to manually edit the triggering address.

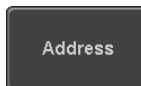

To edit the address, use the *Variable* knob to highlight a binary or hex digit and press *Select*. Use the *Variable* knob to choose a value for the digit and press *Select* to confirm.

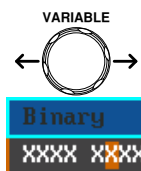

Binary	0,1, X (don't care)
Hex	0~F, X (don't care)

Direction

14. Press *Direction* on the bottom menu and choose the direction from the side menu.



Direction	Write, Read, Read or Write
-----------	----------------------------

SPI Bus Trigger Settings

The SPI bus trigger conditions can be set at any time after the bus setting has been set to SPI.

Panel Operation 1. Set the Bus to SPI in the bus menu. Page 128

2. Press the *Trigger Menu* key.



3. Press *Type* from the bottom menu.



4. Press *Others* from the side menu and select *Bus*.

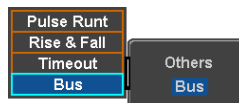

The Trigger on settings will be reflected on the Trigger Configuration icon.



From left: Bus trigger, Trigger source

5. Press *Trigger On* and select the triggering condition for the SPI bus.

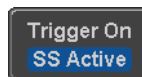

SPI SS Active, MOSI, MISO, MOSI&MISO

Trigger On – Data

If MOSI, MISO or MISO/MOSI was configured for the Trigger On setting, then the number of words and the data can be configured.

6. Press *Data* from the bottom menu.



7. Press *Number of Words* from the side menu and choose the number of words for the data.



SPI 1~32 Words

8. Press *MOSI* or *MISO* from the side menu to edit the triggering data.



To edit the data, use the *Variable* knob to highlight a binary or hex digit and press *Select*. Use the *Variable* knob to choose a value for the digit and press *Select* to confirm.

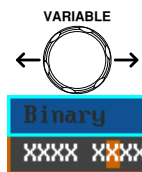

Binary 0,1,X (don't care)

Hex 0~F, X (don't care)

CAN Bus Trigger

The CAN bus trigger conditions can be set at any time after the bus setting has been set to CAN.

Panel Operation 1. Set the Bus to CAN in the bus menu. Page 130

2. Press the *Trigger Menu* key.



3. Press *Type* from the bottom menu.



4. Select *Others* → *Bus* from the side menu. The Bus indicator appears at the bottom of the display.

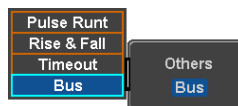

The Trigger on settings will be reflected on the Trigger Configuration icon.



From left: Bus trigger, Trigger source

5. Press *Trigger On* and select the triggering condition for the selected bus.



Trigger On Start of Frame, Type of Frame, Identifier, Data, Id & Data, End of Frame, Missing Ack, Bit Stuffing Err

Trigger On –Type of Frame 6. If *Type of Frame* was configured for the Trigger On setting, then the type of frame can be configured from the side menu.

Type Data Frame, Remote Frame, Error Frame, Overload Frame

Trigger On – Identifier

- If *Identifier/Id & Data* was configured for the Trigger On setting, select the format from the side menu.

Format Standard, Extended

- Press *Identifier* from the side menu to set the identifier data.

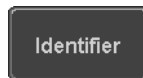

To edit the identifier, use the *Variable* knob to highlight a binary or hex digit and press *Select*. Use the *Variable* knob to choose a value for the digit and press *Select* to confirm.

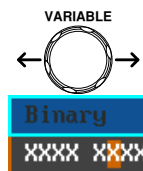

Binary 0,1,X (don't care)

Hex 0~F, X (don't care)

- Press *Direction* on the bottom menu and select the CAN Direction from the side menu.

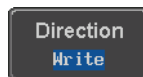

CAN Direction Write, Read, Read or Write

Trigger On - Data

If *Data/Id and Data* was configured for the Trigger On setting, then the triggering data must be configured.

- Press *Data* on the bottom menu.

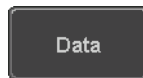

- Press *Number of Bytes* from the side menu and choose the number of bytes for the data.

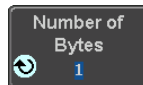

Bytes 1~8 Bytes

12. Press *Data* from the side menu to edit the triggering data.

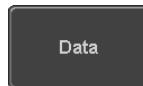

To edit the data, use the *Variable* knob to highlight a binary or hex digit and press *Select*. Use the *Variable* knob to choose a value for the digit and press *Select* to confirm.

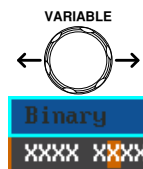

Binary 0,1,X (don't care)

Hex 0~F, X (don't care)

13. Press *Trigger When* from the side menu to choose the triggering condition for the data.

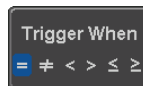

When =, ≠, <, >, ≤, ≥

14. The bus will now trigger when the specified data matches the *Trigger When* conditions.

LIN Bus Trigger

The LIN bus trigger conditions can be set at any time after the bus setting has been set to LIN.

Panel Operation 1. Set the Bus to LIN in the bus menu. Page 131

2. Press the *Trigger Menu* key.



3. Press *Type* from the bottom menu.



4. Select *Others* → *Bus* from the side menu. The Bus indicator appears at the bottom of the display.

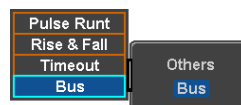

From left: Bus trigger, Trigger source

5. Press *Trigger On* and select the triggering condition for the selected bus.



Trigger On Sync, Identifier, Data, Id and Data, Wakeup Frame, Sleep Frame, Error.

Trigger On – Identifier

6. If *Identifier* or *Id & Data* was configured for the Trigger On setting, press *Identifier* from the bottom menu.

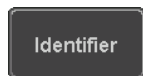

7. Press *Identifier* from the side menu to set the identifier data.

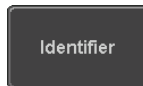

To edit the identifier, use the *Variable* knob to highlight a binary or hex digit and press *Select*. Use the *Variable* knob to choose a value for the digit and press *Select* to confirm.

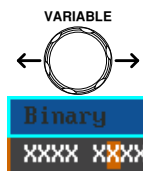

Binary 0,1,X (don't care)

Hex 0~F, X (don't care)

Trigger On - Data

If *Data/Id and Data* was configured for the *Trigger On* setting, then the triggering data must be configured.

8. Press *Data* on the bottom menu.

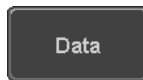

9. Press *Number of Bytes* from the side menu and choose the number of bytes for the data.

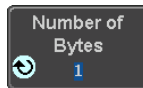

Bytes 1~8 Bytes

10. Press *Data* from the side menu to edit the triggering data.

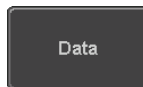

To edit the data, use the *Variable* knob to highlight a binary or hex digit and press *Select*. Use the *Variable* knob to choose a value for the digit and press *Select* to confirm.

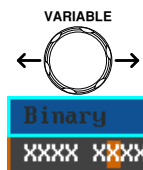

Binary 0,1,X (don't care)

Hex 0~F, X (don't care)

11. Press *Trigger When* from the side menu to choose the triggering condition for the data.

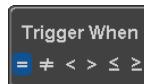

When =, ≠, <, >, ≤, ≥

12. The bus will now trigger when the specified data matches the *Trigger When* conditions.

Common Bus Trigger Settings

Bus Trigger Mode

- Trigger Mode
1. Like the other trigger configurations, the Bus Trigger mode can be set to Auto (Untriggered Roll) and Normal.

2. Press *Mode* from the bottom menu to change the triggering mode.



3. Use the side panel to select *Auto* or *Normal* triggering modes.

Range Auto, Normal

Search

The search feature can be used to search for events on the analog input channels. The events that can be searched for are similar to the events that are used for the trigger system. The only difference is that the search feature uses the measurement threshold levels rather than the trigger level to determine events.

Configuring Search Events

Background Similar to configuring the trigger system, the Search events must first be configured before they can be found.



Luckily the trigger system configuration settings can also be used for the search events. The types of searches are listed below. Please note that a full description of the events can be found in the Trigger section on page 144.

Display

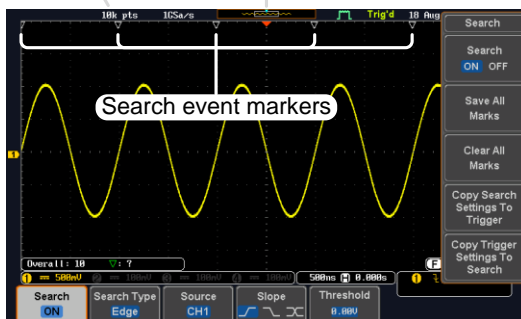
Number of search events Trigger point



Search Event Types	Edge, Pulse Width, Pulse Runt, Rise and Fall Times, FFT Peak*, Bus *The FFT Peak search event doesn't have a trigger equivalent.
--------------------	---

- Panel Operation
1. Press the *Search* menu key. 
 2. Press *Search* from the bottom menu and turn the Search function on. 
 3. Press *Search Type* from the bottom menu and select the type of search. The search events are configured in the same fashion as the trigger events. 

Please see the trigger configuration settings for details:

Event Types:	Edge, Pulse Width, Pulse Runt, Rise/Fall Time, FFT Peak*, Bus
--------------	---



*No trigger equivalent.
 4. To set the threshold levels for the search events (instead of the trigger level that is used for trigger events), use the threshold soft-key from the bottom menu. 
-



Note

The search function can support up to 10,000 events, however only 1,000 events can be displayed on screen at once.

Copying Search Event To/From Trigger Events

Background	As the trigger system and search feature have similar settings, their settings can be used interchangeably by using the Copy functions.	
Interchangeable Settings	Edge, Pulse Width, Pulse Runt, Rise and Fall Times, Bus (FFT Peak has no trigger equivalent)	
Panel Operation	<ol style="list-style-type: none"> 1. Press <i>Search</i> from the lower bezel menu. 	
	<ol style="list-style-type: none"> 2. To copy the settings of the selected search type to the trigger settings, select <i>Copy Search Settings to Trigger</i>. 	
	<ol style="list-style-type: none"> 3. To copy over the current trigger settings to the search settings, press <i>Copy Trigger Settings To Search</i>. 	



Note

If the settings cannot be copied or if there are no trigger settings configured (so that you cannot copy from the trigger settings), then those particular options will not be available.

Search Event Navigation

Background	When using the search feature, each event can be searched for according to the event settings.	
Operation	<ol style="list-style-type: none"> 1. Turn Search on and set the appropriate search type. 	176

2. Search events are marked by hollow white triangles at the top of the graticule.
3. Use the search arrow keys to move between each search event.

Search events can be navigated in both stop and run mode.

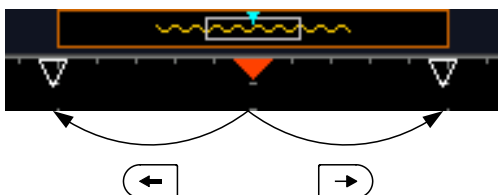

When using the arrow keys to navigate to each event, the “current event” will always be centered on the display.

Save Search Marks

Background The search events can be saved to the graticule display, allowing you to superimpose new search events. Search events are saved over the entire record length, with a maximum of 1000 marks.

Save Marks

1. Press *Search* from the lower bezel menu.
2. Press the *Save All Marks* soft-key.
3. The search event markers will become solid white triangles to indicate that they have been saved.

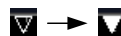
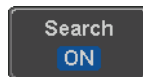



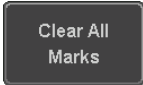

Clear All Marks To clear all the saved marks, press Clear All Marks from the side menu.



 **Note** Each time the Save All Marks function is used, the previously saved marks will also be retained, unless cleared.

Setting/Clearing Single Search Events

Background In addition to searching for search events based on Search Type settings, custom search marks can be created with the Set/Clear key.

- Set Search Event
1. Navigate to a point of interest using  POSITION  the horizontal position knob or some other method.
 

 2. Press the *Set/Clear* key.
 
 3. A marker will be saved at the center of the display.
 - This marker can be navigated to/from in the same way that a normally saved search marker can.

Clear Search Event To clear a set search event, use the search arrows to navigate to the event of interest and press the *Set/Clear* key.



The marker will be deleted from the display.

FFT Peak

Background The FFT Peak search type can be used to mark all FFT peaks that are above a certain threshold.

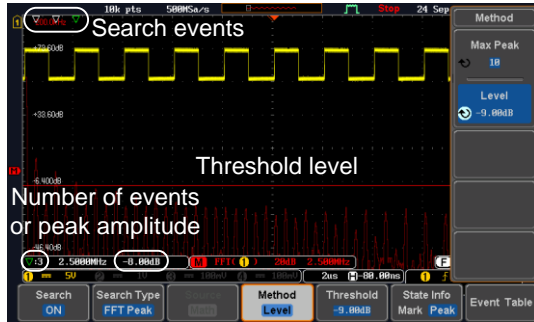

Note

The search function can support up to 10,000 events, however only 1,000 events can be displayed on screen at once.

Panel Operation

1. Turn the FFT math function on. Page 69

2. Press the *Search* menu key.



3. Press *Search* from the bottom menu and turn the Search function on.

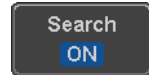

4. Press *Search Type* from the bottom menu and select *FFT Peak* from the side menu.



5. Note that the Math source is automatically selected.

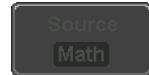

- Next, select the event search method by pressing *Method* from the bottom menu.

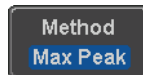

Select *Max Peak* to search by a selected number of "max" peaks.



Select *Level* to set the threshold level for the search events. Any peaks above the threshold level will be seen as a search event.

The threshold level will be mirrored in the Threshold key.



Max Peak 1 ~ 10

Level -100db ~ 100dB

View Number of Peak Events

To view the number of peak events, set *State Info* to Mark. The number of search events will be shown at the bottom of the screen.



View Amplitude of Peak Search Event

To view the position and amplitude of a selected event, set *State Info* to Peak. This information will be shown at the bottom of the display.



Peak Event Table The Event Table function tabulates the amplitude and frequency of each peak event in real time. The event table can also be saved to a USB disk drive. File names are saved as a PeakEventTbXXXX.csv, where XXXX is a number starting from 0001 and is incremented each time the event table is saved.

1. Press *Event Table* from the bottom menu and turn the Event Table function on.

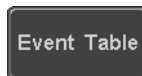

The event table will appear on the screen.

No.	Frequency	Value
1	1.0000MHz	-30.4dB
2	2.0000MHz	-31.2dB
3	3.0000MHz	-32.0dB
4	4.0000MHz	-35.2dB
5	5.0000MHz	-39.4dB
6	6.0000MHz	-44.0dB
7	7.0000MHz	-54.4dB
8	9.0000MHz	-52.0dB
9	10.0000MHz	-51.2dB
10	11.0000MHz	-52.0dB
11	12.0000MHz	-58.4dB
12	497.00MHz	-58.4dB
13	498.00MHz	-56.0dB
14	499.00MHz	-54.4dB

Amplitude

Peak frequency

Peak number

- Save Event Table**
2. To save the event table, insert a USB memory drive into the front panel USB-A port.

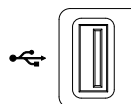

3. Press *Save Event Table*. The event table will be saved as PeakEventTbXXXX.csv.

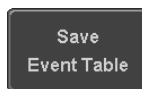

Event Table CSV Format The format for the CSV file is the same as the event table displayed on the GDS-2000E screen; No., Frequency, and Value.

For example:

No.	Frequency	Value
1	1.0000MHz	-29.6dB
2	2.0000MHz	-30.4dB
3	3.0000MHz	-32.0dB

Center Peak Results on Screen To shift the peak events to the center of the screen, press *Selected Peak To Center* from the event table side menu.

A rectangular button with rounded corners, containing the text "Selected Peak To Center" in a sans-serif font. The button has a dark background with light text.

System Settings and Miscellaneous Settings

This section describes how to set the interface, language, time/date, probe compensation signal, erase the internal memory and access useful QR codes.

Select Menu Language

Description The GDS-2000E has a number of different languages to choose from.

Panel Operation 1. Press the *Utility* key.



2. Press *Language* on the lower menu.

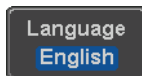

3. Select the language* from the side menu.

*Language selection may differ based on region, and as such are not listed here.

View System Information

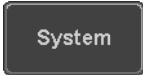
- Panel Operation
1. Press the *Utility* key. 
 2. Press *System* from the lower menu. 
 3. Press *System Info* from the side menu. A display panel will appear showing:
 - Manufacturer name
 - Model name
 - Serial number
 - Firmware version
 - Manufacturer URL

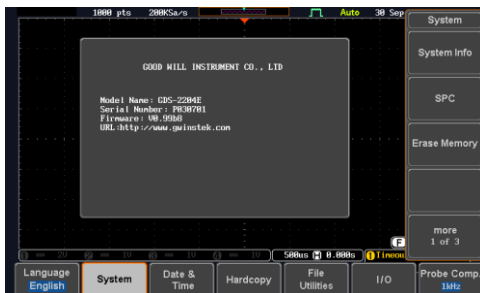

Erase Memory

Background The Erase Memory function will erase all internal waveforms, setup files and labels from internal memory.

Erased Items Waveform 1~20, Setting memory 1~20, Reference 1~4, Labels

- Panel Operation
1. Press the *Utility* key. 

2. Press *System* from the lower menu.

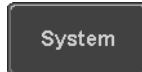

3. Press *Erase Memory* from the side menu.

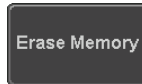

A message will prompt you to press *Erase Memory* again to confirm the process. Pressing any other key will cancel erasing the memory.

4. Press *Erase Memory* again.

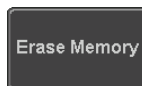

Set Date and Time

- Panel Operation/
Parameter
1. Press the *Utility* key.



2. Press *Date & Time* on the lower menu.

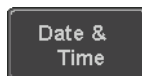

3. Set the *Year*, *Month*, *Day*, *Hour* and *Minute* from the side menu.

Year 2000 ~ 2037

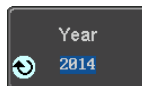

Month 1 ~ 12

Day 1 ~ 31

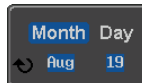

Hour 1~23

Minute 0~59



4. Press *Save Now* from the side menu to save the date and time.

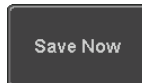

5. Make sure the date/time setting is correctly reflected at the top of the display.



Probe Compensation Frequency

Background The probe compensation output can be set from 1kHz (default) to 200kHz, in steps of 1kHz.

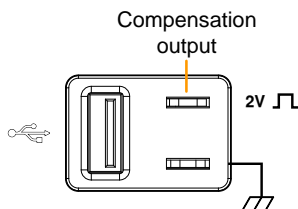

Panel Operation/ Parameter

1. Press the *Utility* key.
2. Press *Probe Comp.* on the lower menu.
3. Press *Frequency* and change the frequency of the probe compensation signal.

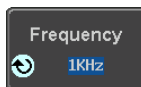

Default Frequency

4. Press *Default* to set the frequency of the probe compensation signal to 1kHz default.

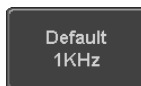





QR Code Reader Function

Background

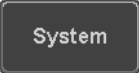
The QR Code reader function displays a number of preset QR codes that link to useful websites.

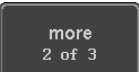
- QR Code Items
- GW Instek website
 - GW Instek contact window (marketing department)

- Panel Operation/ Parameter
1. Press the *Utility* key. 
 2. Press *System* from the lower menu. 
 3. Press *More 1 of 3*, *More 2 of 3* from the side menu. 

 4. Press *QR Code* from the side menu. There will be two pages of QR codes to choose from. 

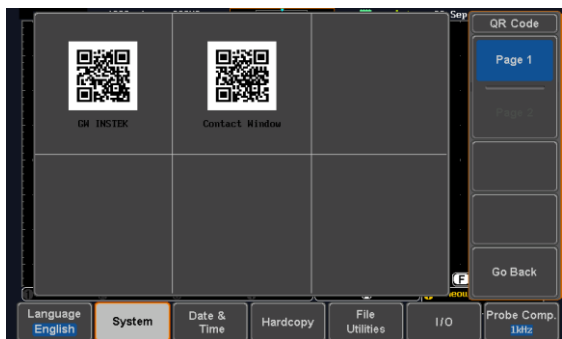
Press *Page 1* or *Page 2* to navigate to each page.



5. Use a QR code reader app on your smart phone or tablet to read one of the QR codes.

APPS

Applications.....	191
Overview	191
Running Applications	192
Using Go-NoGo	193
Using the DVM.....	198
Using the Data Logger	200
Using the Digital Filter.....	202
Remote Disk.....	204
Demo App.....	207

Applications

Overview

Background The APP function allows different software applications to be run. The GDS-2000E comes pre-installed with a number of apps, as described below. Please see your local GW Instek distributor for the latest information on new apps.

Included Applications **Go/No-Go** The Go/No-Go application can be used to set threshold boundaries for input signals. Go/No-Go tests to see if a waveform will fit inside a user-specified maximum and minimum amplitude boundary (template).

DVM The DVM application displays a digital voltage meter readout that floats on the top left-hand side of the screen.

Data Log The Data Log app will log waveform data and/or screenshots at set intervals for set duration of time.

Digital Filter Adds a digital low or high filter to any of the input channels. Each filter can have a user-defined cutoff frequency set.

Mount Remote Disk This app allows the scope to mount a network share drive.

Demo	The Demo app, when combined with the GDB-003 demo board, allows the scope to trigger a number of different signals from the demo board.
------	---

Running Applications

Background	The APP function can host a number of different applications that can be downloaded from the GW Instek website.
------------	---

Panel Operation 1. Press the *APP* key.



2. Press *APP* from the bottom menu.



3. Scroll through each application using the *Variable* knob.

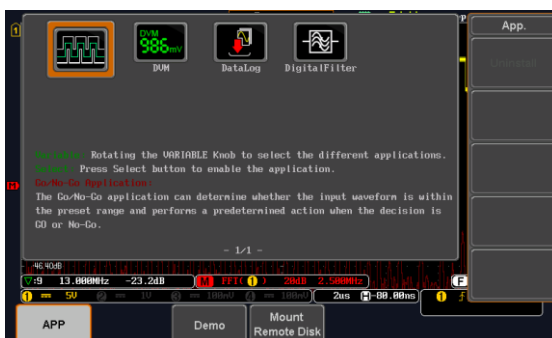

4. Select an application by pressing the *Select* key twice.

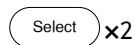

Using Go-NoGo

Background The Go-NoGo test checks if a waveform fits inside a user-specified maximum and minimum boundary. Boundary templates are automatically created from a source channel. Boundary tolerances and violation conditions can be set.

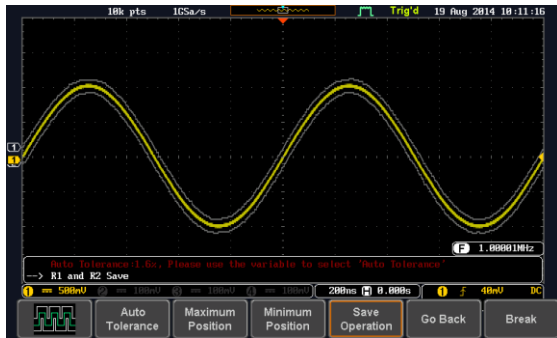

Choose the Go_NoGo application from the APP menu. See page 192.

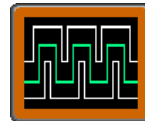

Set Go-NoGo Conditions Select the Go-NoGo conditions (NG When) and actions when a Go-NoGo condition has been met (Violating).

1. Press *NG When* from the bottom menu and select the NoGo conditions:

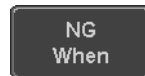

Enter: Sets the NoGo condition to when the input signal stays within the limit boundary.

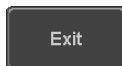

Exit: Sets the NoGo condition to when the input signal exceeds the limit boundary.

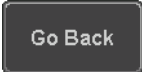
2. Press *Go Back* to return to the previous menu. 

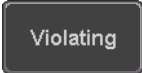
Set Go-NoGo Actions 1. Press *Violating* to set what action to perform when a signal violates the Go-NoGo conditions. 

 The waveform stops when the conditions are violated.

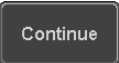
 Ignore violations and continue to monitor the signal. Each violation is counted.

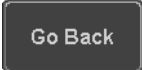
2. Press *Go Back* to return to the previous menu. 

Set Go-NoGo Source 1. Press *Compare Source* from the bottom menu to set the Go-NoGo boundary source. 

 Sets CH1 as the source.

 Sets CH2 as the source.

 Sets CH3 as the source.

 Sets CH4 as the source.

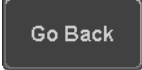
2. Press *Go Back* to return to the previous menu. 

Set Boundary Tolerance 1. To set the Go-NoGo boundary tolerance, press *Reference Mode*. 

Auto Tolerance 2. To set the boundary tolerance as a percentage offset from the source waveform, press *Auto Tolerance* and use the Variable knob.

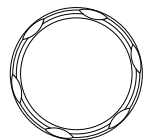

Offset 0.4% ~ 40% (.4% steps)

Maximum and Minimum Position 3. To manually set the template tolerance, press *Minimum Position* or *Maximum Position* and use the Variable knob to set the absolute minimum or maximum position.



or

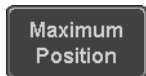

Range Voltage division range

Save Boundary Template 4. Press *Save Operation* to save the tolerance boundaries.

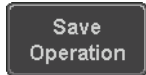

5. The Maximum Position tolerance will be saved to reference waveform R1, and the Minimum Position tolerance to R2.

6. Press *Go Back* to return to the previous menu.

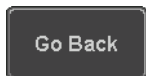

Start Go-NoGo Press *Enable* to start the Go-NoGo test. The Enable button will change to Disable. Pressing *Disable* will stop the Go-NoGo test and toggle the button back to Enable.

If the Violating setting was set to Stop, press *Enable* to restart the test after it has stopped.

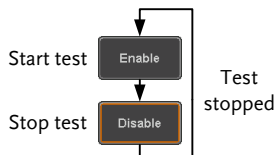

Results

When Go-NoGo is running, the violation/test ratio is displayed in the bottom left-hand corner. The first digit represents the number of violations, and the right hand digit represents the number of tests.

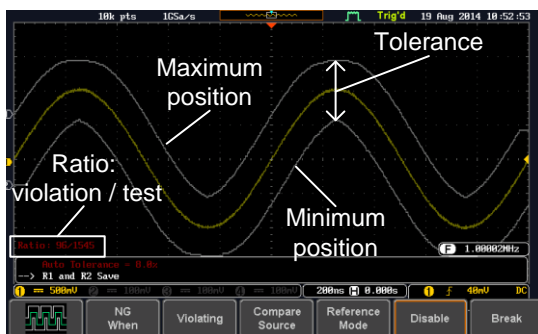

Exit the Application

To exit the application, press *Break*.



 **Note**

After you exit the Go/NoGo app, the boundary templates that were saved to R1 & R2 reference waveforms will still be turned on. See page 236 to turn the reference waveforms off.

Using the Go-NoGo Output

To output the Go-NoGo results to an external device, the Go-NoGo rear panel terminal (open collector) can be used. The Go-NoGo terminal will output a positive pulse each time a NoGo violation has occurred for a minimum of 500us. The voltage of the pulse depends on the external pull-up voltage.



Timing Diagram

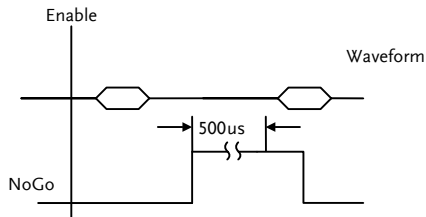

Circuit Diagram

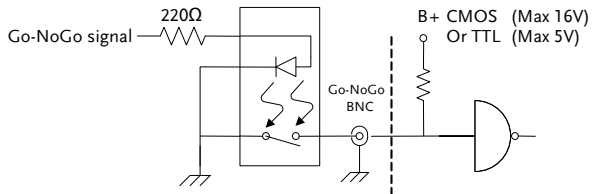

Using the DVM

Background

The DVM app is a digital voltage meter or digital current meter readout that floats on the top left-hand side of the screen. However, please note that if the cursors (refer to page 59) are turned on, the DVM readout will be replaced by the cursor readout.

The DVM app allows you to measure the AC RMS, DC, DC RMS, Duty and frequency of an input signal. This software is especially useful for those measurement applications that require both a DSO and a basic DVM to be used at the same time.

Basic Features:

- 300V input (peak AC + DC) CAT 1
- 3 digit resolution for voltage measurements
- 5 digit resolution for frequency
- Input channel selection

Example

DVM function indicator

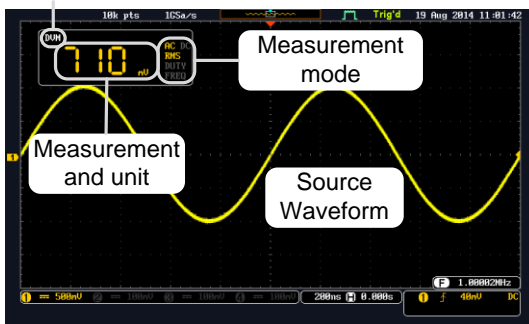

Panel Operation Choose the DVM application from the APP menu. See page 192.



Set Source

1. Press *Source* and select the source channel for the DVM. The probe type setting (voltage or current) determines whether the function acts as a digital volt meter or as a digital current meter for the selected source. See page 118 to set the probe type.

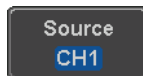

Source CH1 ~ CH4

Mode

The Mode setting determines the measurement mode for the meter.

2. Press *Mode* and select the mode.

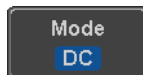

Mode AC RMS, DC, DC RMS, Duty, Frequency

Turn On/Off

3. Press *DVM* and toggle DVM on.



The DVM app will remain running in the background even if other functions are turned on.

Using the Data Logger

Background The Data Log app will log the current waveform data or screenshot at set intervals for a set duration of time.

Basic Features:

- Log up to 100 hours of images or waveform data.
- Interval times of up to 2 seconds (waveform) or 5 seconds (images).

Example

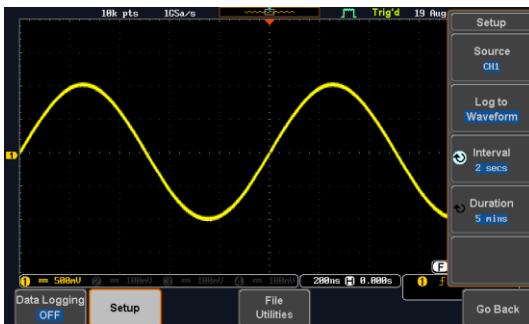

Panel Operation Choose the Data Log application from the APP menu. See page 192.



1. Press *Setup*.



2. Press *Log to* from the side menu and select what type of data to log, waveform data or screenshots.

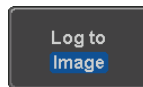

Log to Image, Waveform

3. Press *Source* from the side menu and select a source channel to log if waveforms are to be logged.



Source CH1 ~ CH4, All Displayed

4. Press *Interval* and set the logging interval time.



Interval Data: 2secs ~ 2mins
Image: 5secs ~ 2mins

5. Press *Duration* and select the logging duration time.



Duration 5mins ~ 100hrs.

6. From the bottom menu, press *File Utilities* and set the save file path. See the File Utilities chapter (page 238) for details.

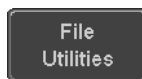

Page 238

Turn On/Off

7. Press *Data Logging* from the bottom menu and toggle Data Logging on.



The data/images will be saved to the designated file path when Data Logging is turned on.

The Data Logging app will remain running in the background even if other functions are turned on.

Set File Path

8. Press *File Utilities* to set the file path.

Page 238

Using the Digital Filter

Background The Digital Filter app is a digital high or low pass filter with a selectable cutoff frequency. The digital filter can be applied to each channel individually or together using the tracking functionality.

Basic Features:

- High pass or low pass filtering of analog channels.
- Selectable cutoff frequencies.
- Tracking function

Example

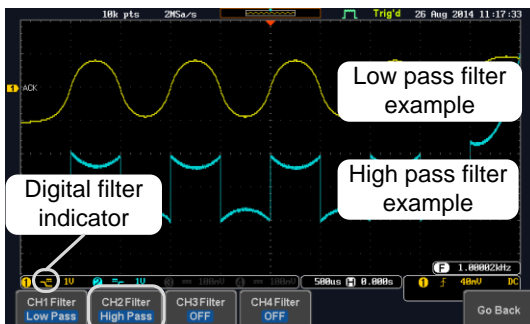

Digital filter type or status

CH1 input: 2Vpp 1kHz square wave, low pass filter with 1kHz cutoff frequency.

CH2 input: 2Vpp 1kHz square wave, high pass filter with 1kHz cutoff frequency.

Panel Operation Choose the Digital filter application from the APP menu. See page 192.



Set Source

1. Select a source channel by pressing *CH1 Filter*, *CH2 Filter*, *CH3 Filter* or *CH4 Filter*.



2. From the side menu press *Filtering* and turn on.

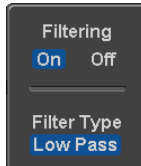

3. Press *Filter Type* and select low or high pass filter.

Type Low Pass, High Pass

4. If Low Pass was selected, press *Upper Limit* to set the low pass cutoff frequency. Likewise if High Pass was selected, press *Lower Limit* to set the high pass cutoff frequency. Only one option will be available at a time.

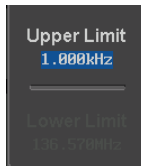

Upper Limit 1Hz ~ 500MHz

Lower Limit 1Hz ~ 500MHz

Tracking

5. Press *Tracking* if you want the settings of the digital filter on each channel to be the same. When a setting is changed on one channel, it is reflected on the other channels.

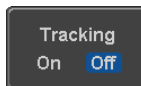

Note

The digital filter settings will still apply to the relevant input signals after leaving the app, unless turned off.

Remote Disk

Background The Remote Disk app allows the scope to mount a network share drive.

Basic Features:

- Save and load files from the network share drive.
- Ability to automatically mount the network share drive at startup.

Example

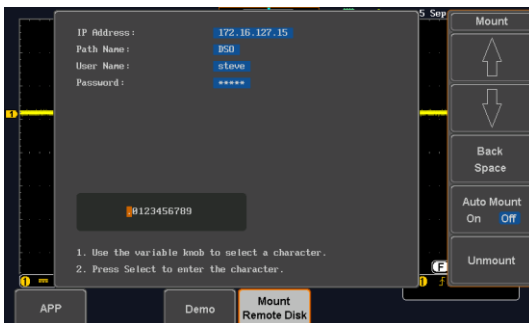

Panel Operation 1. Press the *APP* key.



2. Press *Mount Remote Disk* from the bottom menu.



3. A form will appear (above) prompting you to enter the IP Address, Path Name, User Name and Password.
 - IP Address refers to the IP address of the network share drive.
 - Path Name refers to name of the shared directory of the network drive. This path must be in the root directory of the boot drive of the network disk. No sub-directories are allowed in the path name. For example a path name of "DSO" would be equivalent to C:/DSO.
 - User Name refers to a username with permission to access the share drive.
 - Password refers to the password for the username above.
 - Use the Up and Down soft-keys navigate to each item in the form.
 - Use the Variable knob and Back Space soft-key to enter characters for each item in the form.

-
- Mount/Unmount 4. To mount the network share driver, press *Mount* from the side menu. Press again to unmount.



When the drive is successfully mounted, "Complete!" will be shown on the display.

-
- Auto Mount 5. Press *Auto Mount* to automatically mount the network share drive at startup.

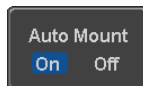

- Set File Path
6. When accessing the file utilities, the network share drive is shown as "Z" drive. Files can be saved to or recalled from the network share drive in the same manner as the internal memory or a USB flash disk. See the File Utilities chapter for usage details.
- Page 238

Example

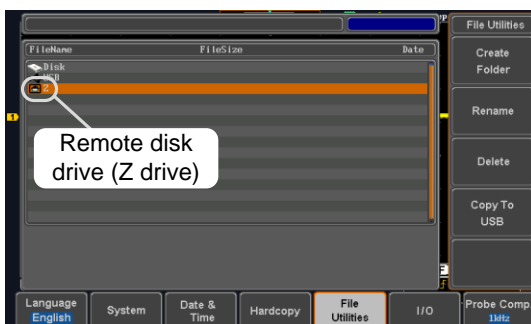

Demo App

Background The Demo app can be used to demonstrate how a number of different signals can be triggered using the GDB-003 demo board.

Basic Features:

- Automatically control the output of the GDB-003 demo board.
- Automatically set the triggering conditions for the signal that is output from the demo board.

Each category/mode are shown below:

Category:Analog

Mode	Function	Mode	Function
1	Auto set	2	XY Mode
3	Gating	4	Pulse Runt
5	Rise Fall	6	Search for analog signals
7	Segments	8	Parallel
9	Update Rate		

Category:Digital

Mode	Function	Mode	Function
1	Pulse Width	2	Delay
3	LM (Long mem.)	4	Logic
5	UART	6	I ² C
7	SPI	8	CAN
9	LIN		

Category:FM

Mode	Function	Mode	Function
1	FM		

Category:Generator

Mode	Function	Mode	Function
1	Generator		

Category:Video

Mode	Function	Mode	Function
1	Video		

Category:CH Decode

Mode	Function	Mode	Function
1	UART	2	I ² C
3	SPI	4	CAN
5	LIN		

Example

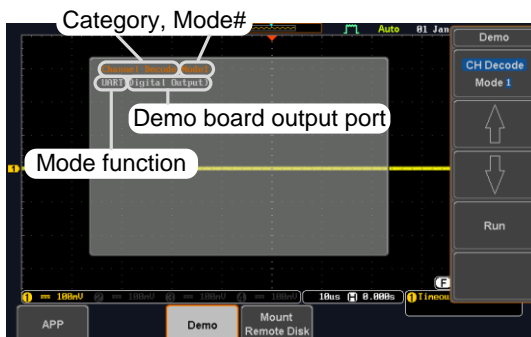

As shown above, the demo category, mode number, mode function and the relevant demo board output ports are shown on the pop-up window.

Panel Operation 1. Press the *APP* key.



2. Press *Demo* from the bottom menu.

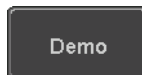

3. Press the *Mode* key from the side menu and choose a demo category.

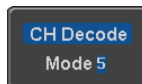

Category Analog, Digital, FM, Generator, Video, CH Decode.

4. Use the *Up* and *Down* arrows on the side menu to select a mode for the selected category.

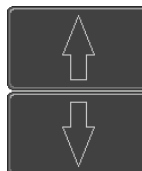

Each mode number refers to a specific demonstration function, listed in the pop-up window.

Demo Board Connection

5. Connect a USB Type A-B cable from the DSO front panel USB A port to the Type B port on the demo board.

After a few moments the demo board will boot up. You will be prompted to select a “Demo Mode” on the demo board LCD screen.

6. Turn the demo board variable knob clockwise until “New GDS Series” appears.
7. Press the Select button on the demo board to select the “New GDS Series” mode.

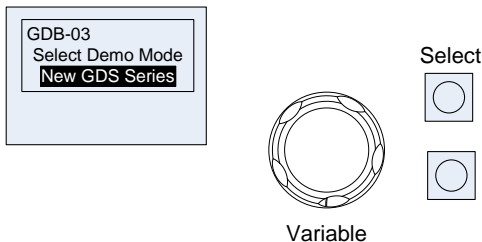

8. Press the Mode key from the side menu and choose a demo function.

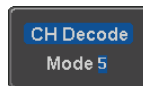

9. For *Analog* category modes, connect 4 probes from CH1 to CH4 on the DSO to the corresponding CH1 to CH4 ANALOG ports on the demo board. Connect the ground clips to the GND ports.

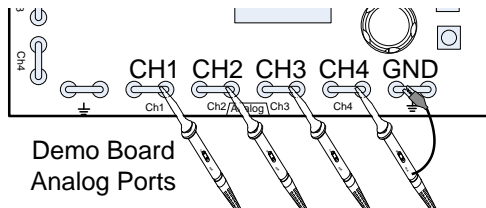

- For *Digital* or *CH Decode* category modes, connect 4 probes from CH1 to CH4 on the DSO to the corresponding CH1 to CH4 DIGITAL ports on the demo board. Connect the ground clips to the GND ports.

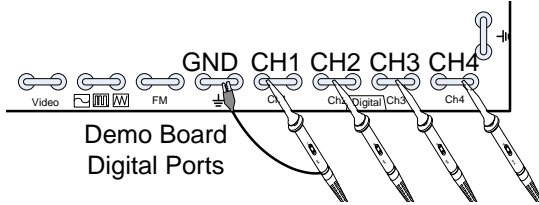

- For the *FM* category mode, connect a probe from CH1 on the DSO to the FM port on the demo board. Connect the ground clip to the GND port.

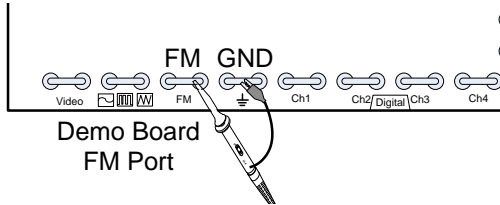

- For the *Generator* category mode, connect a probe from CH1 on the DSO to the Sine, Square, Ramp icon port on the demo board. Connect the ground clip to the GND port.

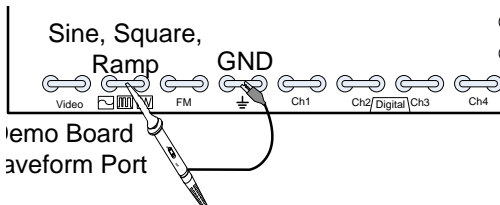

13. For the *Video* category mode, connect a probe from CH1 on the DSO to the Video port on the demo board. Connect the ground clip to the GND port.

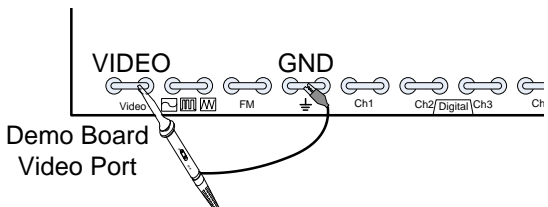

Running the Demo

14. After the demo board has been setup, simply press *Run* from the side panel.

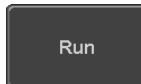

The chosen signal from the demo board will automatically be output and the DSO will be automatically setup to trigger the demo signal.

SAVE/RECALL

File Format/Utility	214
Image File Format.....	214
Waveform File Format.....	214
Spreadsheet File Format.....	215
Setup File Format.....	217
Create/Edit Labels	219
Save	222
File Type/Source/Destination.....	222
Save Image	223
Save Waveform	226
Save Setup.....	228
Recall	230
File Type/Source/Destination.....	230
Recall Default Panel Setting.....	231
Recall Waveform.....	233
Recall Setup.....	234
Reference Waveforms	236
Recall and Display Reference Waveforms	236

File Format/Utility

Image File Format

Format	*.bmp or *.png
Default Filename	DSxxxx.bmp/png
Contents	The display image is 800 by 480 pixels. The background color can be inverted (Ink saver function). Each image file is saved to the current file path as a bitmap or PNG file.

Waveform File Format

Format	DSxxxx.lsf, CH1~CH4.lsf	
	The LSF file format efficiently stores waveforms. This is the file format used for storing and recalling all waveforms that are used with the GDS-2000E series.	
Filename	DSxxxx.lsf, CH1 ~ CH4.lsf	
Waveform Type	CH1 ~ 4	Input channel signal
	REF	Reference waveform
	Math	Math operation result (page 67)
Storage Location	Wave1 ~ Wave20	Waveform files stored to the internal memory. Stored waveforms can be transferred to Ref. 1 ~ 4 to be viewed on the display. (W1 ~ W20 waveforms cannot be directly recalled on the display).

Ref 1~4 Reference waveforms stored in the internal memory, separate from W1 ~ W20. Reference waveforms (Ref 1 ~ 4) can be displayed directly onto the display with amplitude and frequency information. Ref 1~4 are useful for reference purposes. Other waveforms (LSF and W1~20) must be recalled to R1~4 before being displayed.

Contents: The waveform data can be used for detailed
Waveform Data analysis. It consists of the horizontal and vertical data used by the waveform.

Spreadsheet File Format

Format *.csv (Comma-separated values format, can be opened in spreadsheet applications such as Microsoft Excel).

CSV-formatted files can be stored in either a short-memory format or a long-memory format: Detail CSV, Fast CSV. The number of points that are saved depends on the record length settings.

Detail CSV will record both the horizontal and vertical sample points of the waveform. All the points are recorded in scientific notation for analog data.

Fast CSV will only record the vertical amplitude of the sample points. Fast CSV also contains data that enables the horizontal data points to be reconstructed, such as trigger position, etc. Data is recorded as integers.

Note, however, that only fast CSV can be recalled to the internal memory. Detailed CSV cannot be recalled.

Filename DSxxxx.csv

Waveform Type	CH1 ~ 4	Input channel signal
	Ref1~4	Reference waveform
	Math	Math operation result (page 67)
	All Displayed	All the waveforms on the display.

Contents: Detail CSV	<p>Detail CSV waveform data contains channel information such as vertical and horizontal position of a signal for all the recorded points. The following information is included in Detail CSV, where applicable:</p> <ul style="list-style-type: none"> • Format (scope type) • Trigger Level • Label • Vertical units • Vertical position • Horizontal scale • Horizontal mode • Firmware • Mode • Horizontal data • Memory length • Source • Probe ratio • Vertical scale • Horizontal units • Horizontal position • Sampling period • Time • Vertical data
-------------------------	---

Contents: Fast CSV	<p>The following information is included in the Fast CSV waveform files, where applicable:</p> <ul style="list-style-type: none"> • Format (scope type) • IntpDistance (input trigger distance) • Trigger level • Vertical units • Vertical units extend div • Memory length • Trigger address • Source • Vertical units div • Label
-----------------------	--

- Probe type
- Vertical scale
- Horizontal units
- Horizontal position
- SincET mode (sampling mode)
- Horizontal old scale
- Firmware
- Mode
- Probe ratio
- Vertical position
- Horizontal scale
- Horizontal mode
- Sampling period
- Horizontal old position
- Time
- Raw vertical waveform data

Setup File Format

Format DSxxxx.set (proprietary format)
 The setup file saves or recalls the following settings.

Contents	Acquire <ul style="list-style-type: none"> • Mode • Sample rate • XY 	<ul style="list-style-type: none"> • Sample mode • Record Length
	Display <ul style="list-style-type: none"> • Mode • Persistence • Waveform intensity • Graticule intensity 	<ul style="list-style-type: none"> • Backlight intensity • Graticule • Backlight • Auto-dim

Channel	<ul style="list-style-type: none"> • Scale • Channel • Coupling • Impedance • Invert • Bandwidth 	<ul style="list-style-type: none"> • Expand • Position • Probe • Probe attenuation • Deskew
Cursor	<ul style="list-style-type: none"> • Horizontal cursor • H Unit 	<ul style="list-style-type: none"> • Vertical cursor • V Unit
Measure	<ul style="list-style-type: none"> • Source • Gating • Statistics 	<ul style="list-style-type: none"> • Display • High-Low • Reference levels
Horizontal	<ul style="list-style-type: none"> • Scale 	
Math	<ul style="list-style-type: none"> • Source1 • Operator • Source2 	<ul style="list-style-type: none"> • Position • Unit/Div • Math Off
FFT Math	<ul style="list-style-type: none"> • Source • Vertical Units • Window 	<ul style="list-style-type: none"> • Vertical position • Horizontal position
Advanced Math	<ul style="list-style-type: none"> • Expression • VAR1 • VAR2 	<ul style="list-style-type: none"> • Position • Unit/Div
Trigger	<ul style="list-style-type: none"> • Type • Source • Coupling • Alternate • Rejection • Noise Rejection 	<ul style="list-style-type: none"> • Slope • Level • Mode • Trigger When • Timer • Holdoff

- | | | |
|-----------------|---|---|
| Utility | <ul style="list-style-type: none"> • Language • Hardcopy key • File Format | <ul style="list-style-type: none"> • Ink Saver • Buzzer • Assign Save • Probe Comp. |
| Save/
recall | <ul style="list-style-type: none"> • Image file format | <ul style="list-style-type: none"> • Data file format |

Create/Edit Labels

Overview Reference files, Setup files and the analog input channels can have individual file labels set.

For the analog channels and reference waveforms, the file label can be displayed next to the channel/reference indicator.

The file labels are also used to easily identify reference files, setup files or channels when saving or recalling waveforms and setups.

Example

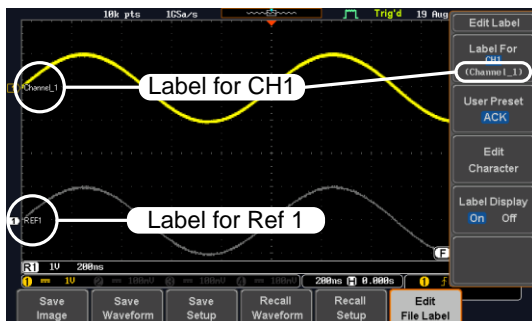

In the example above, the file label for channel 1 is displayed next to the channel indicator and is also displayed in the *Edit Label* menu. The Ref_1 file label is shown next to the reference indicator.

Panel Operation 1. Press the *Save/Recall* key from the front panel.



2. Press *Edit File Label* from the bottom menu.

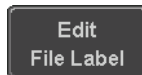

3. Press *Label For* and select the item that you want to create the label for.



Label For CH1~CH4, Ref1~4, Set1~20, Math

4. To choose a preset label, Press *User Preset* from the side menu and choose a label.



Labels ACK, AD0, ANALOG, BIT, CAS, CLK, CLOCK, CLR, COUNT, DATA, DTACK, ENABLE, HALT, INT, IN, IRQ, LATCH, LOAD, NMI

Edit Label

1. Press *Edit Character* to edit the current label.

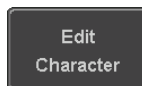

2. The Edit Label window appears.

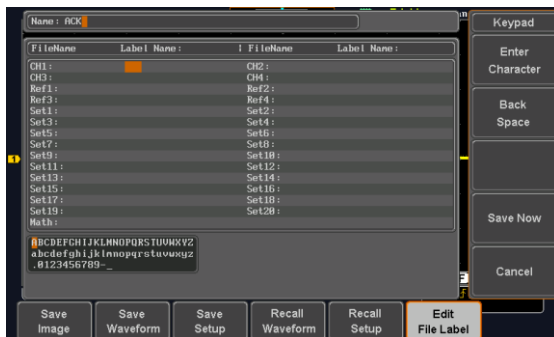

3. Use the Variable knob to highlight a character.

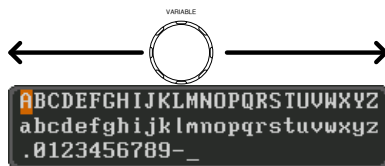

Press *Enter Character* to select a number or letter.

Enter
Character

Press *Back Space* to delete a character.

Back
Space

Press *Save Now* to save the label and return to the previous menu.

Save Now

To cancel the editing the label and return to the previous menu, press *Cancel*.

Cancel

Display Label

To display the currently selected file label on the screen next to its respective indicator, toggle *Label Display* to On.

Label Display
On Off

Conversely, if you want to remove the currently selected file label from the display, toggle *Label Display* to Off.

Save

File Type/Source/Destination

Item	Source	Destination
Panel Setup (DSxxxx.set)	<ul style="list-style-type: none"> • Front panel settings 	<ul style="list-style-type: none"> • Internal memory: Set1 ~ Set20 • File system: Disk, USB
Waveform Data (DSxxxx.csv) (DSxxxx.lsf) (CH1~CH4.lsf, Ref1~Ref4.lsf, Math.lsf)* ALLxxxx.csv	<ul style="list-style-type: none"> • Channel 1 ~ 4 • Math operation result • Reference waveform Ref1~4 • All displayed waveforms 	<ul style="list-style-type: none"> • Internal memory: Reference waveform Ref1~4, Wave1 ~ Wave20 • File system: Disk, USB

Display Image (DSxxxx.bmp/png)
(Axxx1.bmp/png)**

- Display image
- File system: Disk, USB

*Stored in ALLXXXX directories when All Displayed waveforms are saved.

**Stored in ALLXXXX directories when the Hardcopy key is assigned to save Waveform, Setup or All.

Note: By default all filenames/ directories are named DSxxxx/ ALLxxxx where xxxx is a number starting from 0001 and is incremented by one after each save.

Save Image

Images can be saved either using the Save/Recall key or by using the Hardcopy key. To save images using the Hardcopy key, see the hardcopy section on page 245.

- Panel Operation
1. To save to USB, connect a USB drive to the front panel USB port. If a USB drive is not connected, images can still be saved to the internal memory.

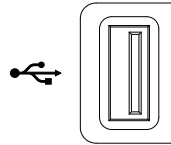

2. Press the *Save/Recall* key from the front panel.



3. Press *Save Image* from the bottom menu.



4. Press *File Format* to choose PNG or BMP file types.

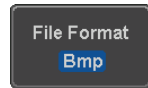

Range DSxxxx.bmp, DSxxxx.png

5. Press *Ink Saver* to toggle Ink Saver On or Off.

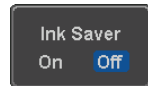

Ink Saver On

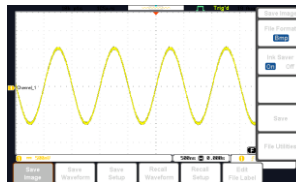

Ink Saver Off

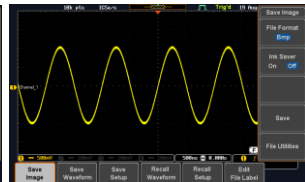

6. Press *Save* from the side menu to save the display as an image file.



7. You will automatically be taken to a file utility where you will be able to edit the name of the file.

8. To edit the file name, use the *Variable* knob to highlight a character.

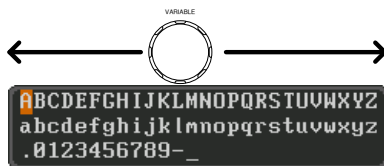

Press *Enter Character* or the *Select* key to select a number or letter.

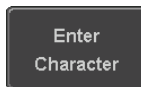

Press *Back Space* to delete a character.



9. Press *Save Now* to save the file. The file name need not have been edited to save the file.



Note: Pressing *Cancel* will cancel the save operation and return you to the *Save/Recall* menu.

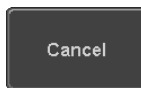

After *Save Now* has been pressed the file will be saved.



Note

The file will not be saved if the power is turned off or the USB drive is taken out before the message ends.

File Utility

To edit the internal memory or the USB flash drive contents (create/delete/rename files and folders) or to edit the default file path, press *File Utilities* from the side menu. See page 238 for details.



Save Waveform

- Panel Operation
- To save to an external USB flash drive, connect the drive to the front panel USB port. If a USB drive is not connected, files can still be saved to the internal memory.

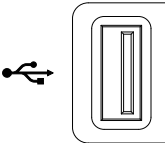

 - Press the *Save/Recall* key from the front panel.

 - Press *Save Waveform* from the bottom menu.

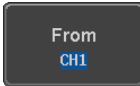
 - Choose the *From* waveform on the side menu.

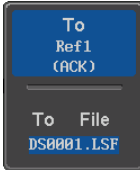

Source CH1~4, Math, Ref1~4, All Displayed
 - Press *To* (internal memory) or *To File* and choose a destination to save.



To Ref1~4, Wave1~20

To File Format: LSF, Detail CSV, Fast CSV
 - Press *Save* to save the file.

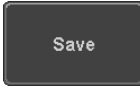
 - If you are saving to a file, a file utility appears where you will be able to edit the name of the file from the default "DSXXX" filename.

- To edit the filename, use the *Variable* knob to highlight a character.



Press *Enter Character* or the *Select* key to select a number or letter.

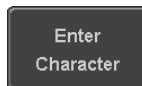

Press *Back Space* to delete a character.



- Press *Save Now* to save the file. The filename need not have been edited to save the file.

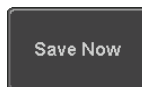

Note: Pressing *Cancel* will cancel the save operation and return you to the Save/Recall menu.

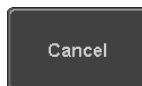

After *Save Now* has been pressed the file will be saved.

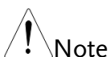

Note

The file will not be saved if the power is turned off or the USB drive is taken out before the message ends.

File Utility

To edit the internal memory or the USB flash drive contents (create/delete/rename files and folders), press *File Utilities*. For details, see page 238.

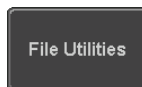

Save Setup

Panel Operation

- To saving to an external USB flash drive connect the drive to the front or rear panel USB port. If a USB drive is not connected, files can be saved to the internal memory.

Front Panel

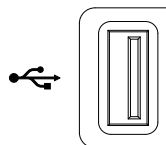

- Press the *Save/Recall* key from the front panel.



- Press *Save Setup* from the bottom menu.



- Press *To* (internal memory) or *To File* and choose a destination to save to.

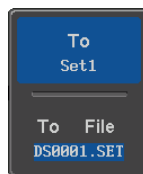

To Set1~Set20

To File DSxxxx.set

- Press *Save* to confirm saving. When completed, a message appears at the bottom of the display.



- If you are saving to a file, a file utility appears where you will be able to edit the name of the file from the default "DSxxxx" filename.

- To edit the filename, use the *Variable* knob to highlight a character.

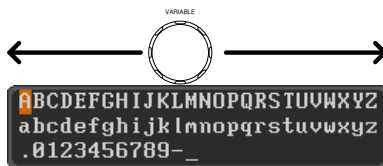

Press *Enter Character* or the *Select* key to select a number or letter.

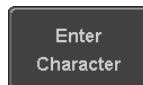

Press *Back Space* to delete a character.



8. Press *Save Now* to save the file. The filename need not have been edited to save the file.



Note: Pressing *Cancel* will cancel the save operation and return you to the *Save/Recall* menu.

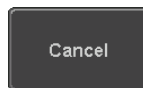

After *Save Now* has been pressed the file will be saved.

Setup saved to USB : /DS0001.SET.

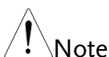

Note

The file will not be saved if the power is turned off or the USB drive is taken out before the message ends.

File Utility

To edit the internal memory or the USB flash drive contents (create/delete/ rename files and folders) or to set the file path, press *File Utilities*. For details, see 238.

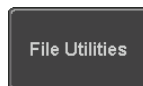

Edit Label

To edit labels for Setup files, press *Edit Label*. For more details on editing labels, see page 219.

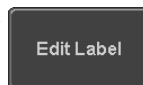

Recall

File Type/Source/Destination

Item	Source	Destination
Default Panel Setup	<ul style="list-style-type: none"> Factory installed setting 	<ul style="list-style-type: none"> Current front panel
Reference Waveform	<ul style="list-style-type: none"> Internal memory: Ref1~4 	<ul style="list-style-type: none"> Current front panel
Panel Setup (DSxxxx.set)	<ul style="list-style-type: none"> Internal memory: S1 ~ S20 File system: Disk, USB 	<ul style="list-style-type: none"> Current front panel
Waveform Data (DSxxxx.lsf, DSxxxx.csv**, (CH1~CH4.lsf, Ref1~Ref4.lsf, Math.lsf)*	<ul style="list-style-type: none"> Internal memory: Wave 1 ~ Wave20 File system: Disk, USB 	<ul style="list-style-type: none"> Reference waveform 1 ~ 4

*Recalled from ALLXXX directories. Note that Allxxxx.csv cannot be recalled to the oscilloscope.

**Detail CSV files cannot be recalled to the oscilloscope.

Recall Default Panel Setting

- Panel Operation
1. Press the *Default* key. Default
 2. The screen will update with the default panel settings.

Setting Contents The following is the default (factory) setting contents.

Acquire	Mode: Sample	XY: OFF
	Record Length: 10k	Expand: By Center
Display	Mode: Vector	Persistence: 240ms
	Waveform intensity: 50%	Graticule intensity: 50%
	Backlight Intensity: 80%	Backlight Auto-dim: On
	Time: 10min	Graticule: full 
Channel	Scale: 100mV/Div	CH1: On
	Coupling: DC	Impedance: 1MΩ
	Invert: Off	Bandwidth: full
	Expand: By Ground	Position: 0.00V
	Probe: Voltage	Probe attenuation: 1x
	Deskew: 0s	
Cursor	Horizontal cursor: Off	Vertical Cursor: Off
Measure	Source: CH1	Gating: Screen
	Display All: Off	High-Low: Auto
	Statistics: Off	Mean & Std Dev
		Samples: 2
	High Ref: 90.0%	Mid Ref: 50.0%
	Low Ref: 10.0%	

Horizontal	Scale: 10us/Div	Position: 0.000s
Math	Source1: CH1	Operator: +
	Source2: CH2	Position: 0.00 Div
	Unit/Div: 200mV	Math Off
FFT	Source: CH1	Vertical Units: dBV RMS
	Window: Hanning	Vertical: 20dB
	Horizontal:5MHz/div	
Advanced Math	Expression: CH1+CH2	VAR1: 0
	VAR2: 1	Position: 0.00Div
	Unit/div: 500mV	
APP	App: Go-NoGo, DVM, Datalog, Mount Remote Disk	
Trigger	Type: Edge	Source: CH1
	Coupling: DC	Alternate: Off
	Noise Rejection: Off	Slope: Positive
	Level: 0.00V	Mode: Auto
	Holdoff: 10.0ns	
Utility	Hardcopy: Save	Ink Saver: Off
	Assign Save To: Image	File Format: Bmp
	Probe Comp.: 1kHz	

Recall Waveform

- Panel Operation
1. For recalling from an external USB flash drive, connect the drive to the front or rear panel USB port.

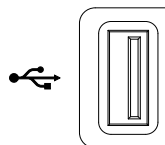

2. The waveform must be stored in advance. See page 226 for waveform store details.

3. Press the *Save/Recall* key.



4. Press *Recall Waveform* from the bottom menu. The Recall menu appears.

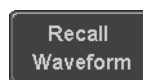

5. Press *From* (internal memory) or *From File* and choose a source to recall from.

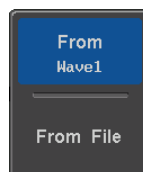

From Wave1~20

From File* File format: Lsf, Fast Csv

*Only files in the current file path will be available, this includes files saved in the ALLxxxx directories.

Allxxxx.csv files cannot be recalled to the oscilloscope.

Only the "Fast CSV", "LSF" files can be recalled to the oscilloscope.

6. Press *To* and select the reference waveform to recall to.

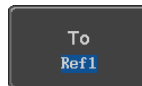

To Ref1~4

7. Press *Recall Now* to recall the waveform. The reference waveform will appear on the screen when successful.

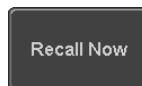

File Utility

To edit USB flash drive contents (create/ delete/ rename files and folders) or to set the file path, press *File Utilities*. For details, see page 238.

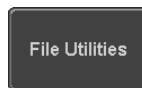

Recall Setup

- Panel Operation
1. (For recalling from an external USB flash drive) Connect the drive to the front or rear panel USB port.

Front Panel

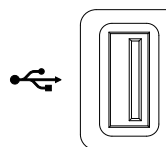

2. Press the *Save/Recall* key.
3. Press *Recall Setup* from the bottom menu.

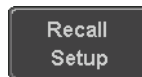

4. Press *From* (internal memory) or *From File* and choose a source to recall from.

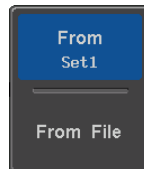

From Set1~20

From File DSxxxx.set (USB, Disk)*

* Only files in the current file path will be available.

5. Press *Recall Now* to confirm recalling. When completed, a message appears at the bottom of the display.

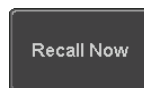

Setup recalled from Set1.



The file will not be recalled if the power is turned off or the USB drive is taken out before the message appears.

File Utility

To edit the internal memory or the USB flash drive contents (create/delete/ rename files and folders) or to set the file path, press *File Utilities*. For details, see page 238.

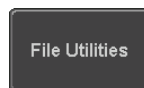

Edit Label

To edit labels for Setup files, press *Edit label*. For more details on editing labels, see page 219.

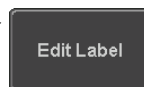

Reference Waveforms

Recall and Display Reference Waveforms

Panel Operation A reference waveform must be stored in advance. See page 226 to store waveforms as reference waveforms.

1. Press the *REF* key on the front panel.







2. Pressing *R1~R4* repeatedly will toggle the corresponding reference waveform OFF/ON.

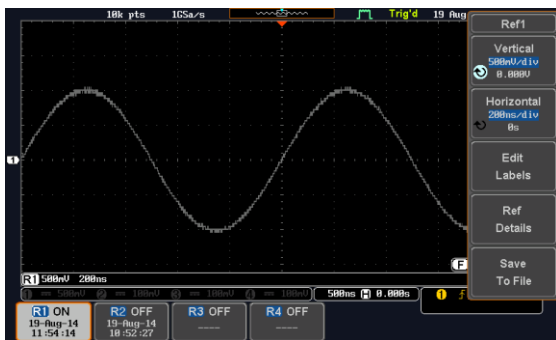
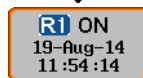
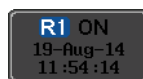

Turning *R1~R4* ON will open the corresponding reference menu.

3. If a reference waveform is ON but not active, its reference menu can be opened by pressing the corresponding *R1~R4* key from the bottom menu.

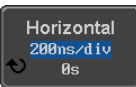
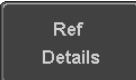

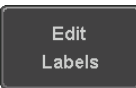
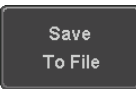
Vertical Navigation	Press <i>Vertical</i> repeatedly from the side menu to choose to edit the vertical position or Unit/Div. Use the Variable knob to edit the values.	
Horizontal Navigation	Press <i>Horizontal</i> repeatedly from the side menu to choose to edit the Time/Div or the horizontal position. Use the Variable knob to edit the value.	
View Reference Waveform Details	Pressing <i>Ref Details</i> will display the reference waveform details.	
Details: Sample Rate, Record Length, Date		
		
Edit Labels	To edit labels for Setup files, press <i>Edit Labels</i> . For more details on editing labels, see page 219.	
Save Reference Waveforms	To save reference waveforms, press <i>Save to File</i> . For more details on saving waveforms, see page 226.	

FILE UTILITIES

The file utilities are used each time files need to be saved to internal or external memory. The file utilities can create directories, delete directories, rename files as well as copy files from internal memory to USB. The File Utilities menu also sets the file path for saving and recalling files from the Save/Recall menu.

File Navigation	239
Create Folder	241
Rename File	242
Delete File or Folder	243
Copy File to USB	244

File Navigation

The File Utilities menu can be used to choose files or to set the file path for saving/recalling files.

File System

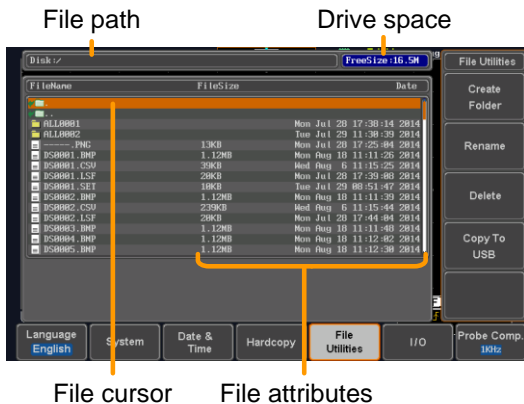

Panel Operation

1. Press the *Utility* key.
2. Press *File Utilities* from the bottom menu.

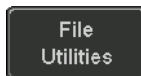

3. The file system appears.

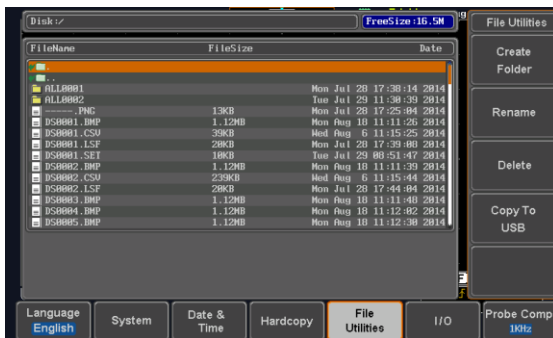

4. Use the *Variable* knob to move the file cursor up and down.

Use the *Select* key to choose a file or directory or to set the file path.

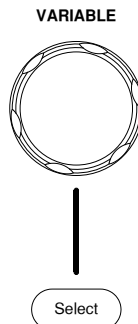

Note

- When a USB flash drive is used, the file path is remembered each time the USB flash drive is used. This saves you the hassle of setting the USB file path each time the USB flash drive is inserted into the scope.

Create Folder

Panel Operation 1. Press the *Utility* key.



2. Press *File Utilities* from the bottom menu.



3. Use the *Variable* knob and *Select* key to navigate the file system.

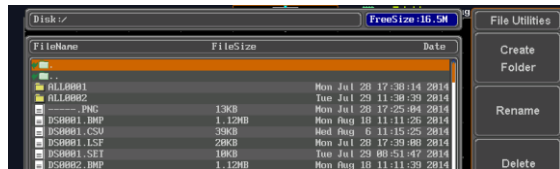

Create Folder 4. Press *Create Folder* to make a new directory at the selected location.

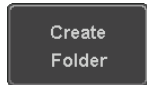

5. Use the *Variable* knob to highlight a character.



Press *Enter Character* or the *Select* key to select a number or letter.

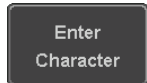

Press *Back Space* to delete a character.

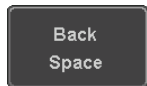

6. Press *Save Now* to create the folder.

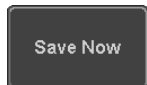

Cancel Press *Cancel* to cancel the operation.

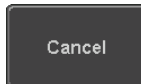

Rename File

Panel Operation 1. Press the Utility key.



2. Press *File Utilities* from the bottom menu.

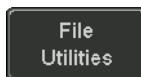

3. Use the Variable knob and select key to choose a file to rename.



4. Press *Rename* when a file is chosen.

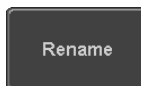

5. Use the *Variable* knob to highlight a character.



Press *Enter Character* or the *Select* key to select a number or letter.

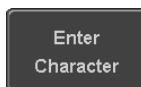

Press *Back Space* to delete a character.



6. Press *Save Now* to rename the folder or file.

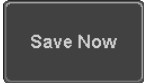

Delete File or Folder

Panel Operation

1. Press the *Utility* key.
2. Press *File Utilities* from the bottom menu.
3. Use the Variable knob and select key to navigate the file system to choose a file.

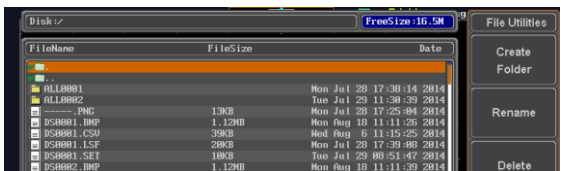
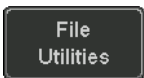
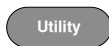

4. Press *Delete* to delete the selected file.
5. Press *Delete* again to confirm the deletion.

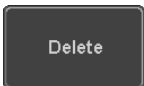
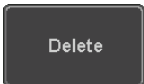

Copy File to USB

- Panel Operation
1. Connect a USB drive to the front panel USB port.

Front Panel

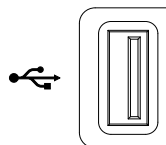

2. Press the *Utility* key.



3. Press *File Utilities* from the bottom menu.

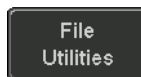

4. Use the *Variable* knob and *Select* key to navigate the file system to choose a file from internal memory.



5. Press *Copy to USB* to copy the selected file to the USB drive.



If the same file name already exists on the USB drive, it will be copied over.

HARDCOPY KEY

The Hardcopy key is used as quick-save or quick-print key. The Hardcopy key can be assigned either to printout screenshots or to save files.

When assigned to “Print” the screen image can be printed to a PictBridge compatible printer using the USB device port. To reduce the amount of printer ink used for each print, images can be printed using the Ink Saver function.

When assigned to “Save”, pressing the Hardcopy key can be used to save a screen shot, a waveform, or the current setup, depending on the configuration.

Printer I/O Configuration

- Panel Operation
1. Connect a PictBridge printer to the USB device port on the rear panel.

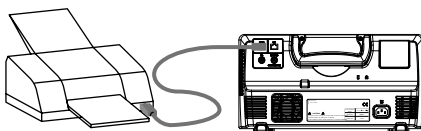



2. Press the *Utility* key.
3. Press *I/O* from the bottom menu.
4. Press *USB Device Port* from the side menu and select *Printer*.

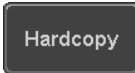
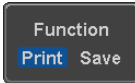

Print Output

Ensure the USB port has been configured for the printer and the printer is connected to the scope before trying to print, see page 245.

- Panel Operation
1. Press the *Utility* key. 
 2. Press *Hardcopy* from the bottom menu. 
 3. On the side menu, press *Function* and select *Print*. 
 4. Press the *Hardcopy* key to print. The display image is printed out. 

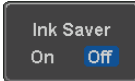
Ink Saver To have a white background on the printed display image, set *Ink Saver* to On. 

Ink Saver On

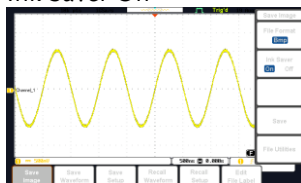

Ink Saver Off

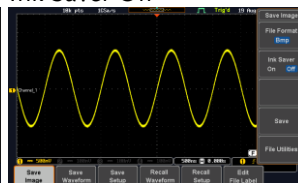

Save - Hardcopy Key

Background When the Hardcopy key is assigned to “Save”, pressing the Hardcopy key can be used to save a screen shot, a waveform, or the current setup, depending on the configuration.

Panel Operation 1. If you wish to save to USB, connect a USB drive to the front panel USB port, otherwise the file will save to internal memory.

Front

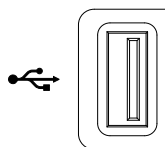

2. Press the *Utility* key.



3. Press *Hardcopy* from the bottom menu.

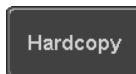

4. On the side menu, press *Function* to select Save.

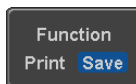

5. Press *Assign Save To* and select which type of file will be saved when the Hardcopy key is pressed.

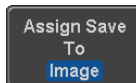

File Type: Image, Waveform, Setup, All

6. Press the *Hardcopy* key to save the file*.



A message will appear when the save is successful.

Image saved to USB :/DS0197.BMP.

Image File Format

1. For image files the file format can be selected with the *File Format* key.

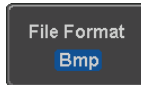

Format: BMP, PNG

Ink Saver

2. To have a white background for image files, set *Ink Saver* to On.

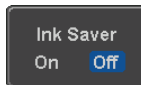

Ink Saver On

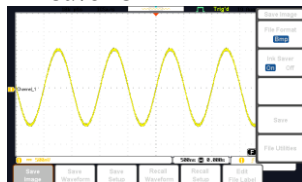

Ink Saver Off

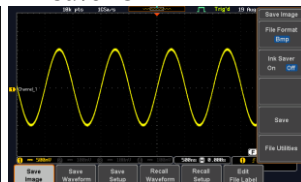

*Each time the Hardcopy key is used to save waveforms or setup files, the files are saved into a new directory each time. The save directory is labeled ALLXXXX, where XXXX is a number that is incremented with each save. This directory is created in either the internal memory or to a USB flash drive.

REMOTE CONTROL CONFIG





This chapter describes basic configuration for remote control. For a command list, refer to the programming manual downloadable from GWInstek website, www.gwinstek.com

Interface Configuration	250
Configure USB Interface.....	250
USB Functionality Check.....	251
Configure the Ethernet Interface.....	252
Configure Socket Server.....	254
Socket Server Functionality Check	255

Interface Configuration

Configure USB Interface

USB Configuration	PC side connector	Type A, host
	GDS-2000E side connector	Type B, device
	Speed	1.1/2.0
	USB Class	CDC (communications device class)

- Panel Operation
1. Press the Utility key. 
 2. Press I/O from the bottom menu. 
 3. Press *USB Device Port* from the side menu and select *Computer*. 
 4. Connect the USB cable to the rear panel device port. 
 5. When the PC asks for the USB driver, select the USB driver included on the accompanying User Manual CD or download the driver from the GW Instek website, www.gwinstek.com, in the GDS-2000E Download section. The driver automatically sets the GDS-2000E as a serial COM port (Shown as VPO in the PORTS node).

USB Functionality Check

Terminal Application

Invoke a terminal application such as RealTerm.

Set the COM port, baud rate, stop bit, data bit, and parity accordingly.

To check the COM port number and associated port settings, see the Device Manager in the PC. For Windows 7:

Control panel → *Hardware and Sound* → *Device Manager*

Example: Configuring RealTerm:

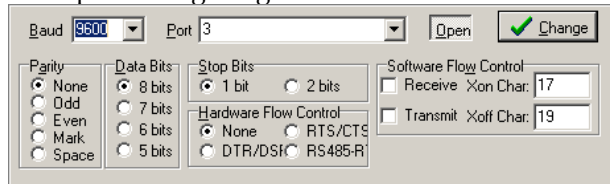

Functionality Check

Key in this query command via the terminal application.

*idn?

This should return the Manufacturer, Model number, Serial number, and Firmware version in the following format.

GW,GDS-2202E,PXXXXXX,V1.00





Note

For further details about remote control and remote commands, please see the GDS-2000E programming manual, available on the GW Instek website.

Configure the Ethernet Interface

Ethernet Configuration	MAC Address	Domain Name
	Instrument Name	DNS IP Address
	User Password	Gateway IP Address
	Instrument IP Address	Subnet Mask
		HTTP Port 80 (fixed)

Background The Ethernet interface is used for remote control using a socket server connection. For details, please see the Socket Server section on page 254.

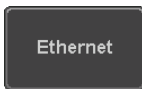
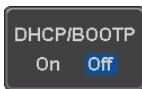
- Panel Operation**
1. Connect the Ethernet cable to the LAN port on the rear panel. 
 2. Press the *Utility* key. 
 3. Press *I/O* from the bottom menu. 
 4. Press *Ethernet* from the side menu. 
 5. Set *DHCP/BOOTP* to *On* or *Off* from the side menu. 

 **Note**

IP addresses will automatically be assigned with DHCP/BOOTP set to on. For Static IP Addresses, DHCP/BOOTP should be set to off.

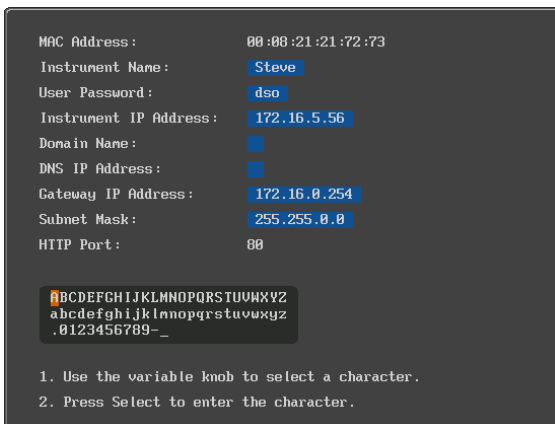

6. Use the *Up* and *Down* arrows on the side menu to navigate to each Ethernet configuration item.

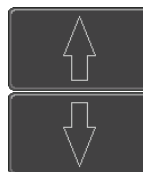

Items MAC Address, Instrument Name, User Password, Instrument IP Address, Domain Name, DNS IP Address, Gateway IP Address, Subnet Mask

Note: HTTP Port is fixed at 80.

7. Use the *Variable* knob to highlight a character and use the *Select* key to choose a character.

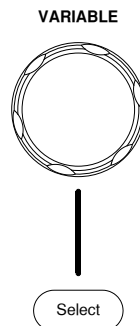

Press *Backspace* to delete a character.



Press *Save Now* to save the configuration. Complete will be displayed when successful.



Configure Socket Server

The GDS-2000E supports socket server functionality for direct two-way communication with a client PC or device over LAN. By default, the Socket Server is off.

Configure Socket Server

1. Configure the IP address for the GDS-2000E.

Page 252

2. Press the *Utility* key.



3. Press *I/O* from the bottom menu.

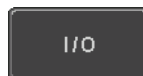

4. Press *Socket Server* from the side menu.

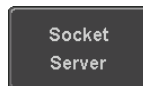

5. Press *Select Port* and choose the port number with the Variable knob.



Range 1024~65535

6. Press *Set Port* to confirm the port number.

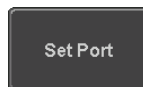

7. The Current Port icon will update to the new port number.



8. Press *Server* and turn the socket server On.

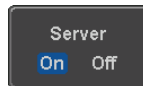

Socket Server Functionality Check

NI Measurement and Automation Explorer To test the socket server functionality, National Instruments Measurement and Automation Explorer can be used. This program is available on the NI website, www.ni.com.

- | | | |
|-----------|--|---|
| Operation | 1. Configure the IP address for the GDS-2000E. | Page 252 |
| | 2. Configure the socket port. | Page 254 |
| | 3. Start the NI Measurement and Automation Explorer (MAX) program. Using Windows, press: |  |

Start>All Programs>National Instruments>Measurement & Automation



4. From the Configuration panel access;

My System>Devices and Interfaces>Network Devices

5. Right click *Network Devices* and select *Create New Visa TCP/IP Resource...*

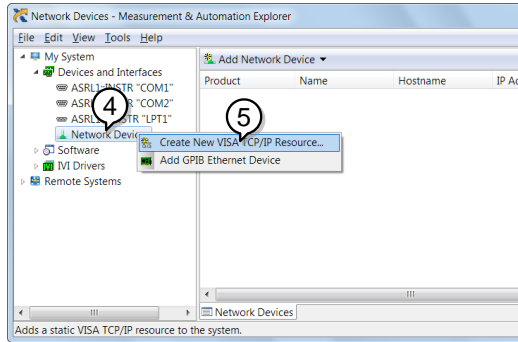

6. Select *Manual Entry of Raw Socket* from the popup window.
7. Click *Next*.

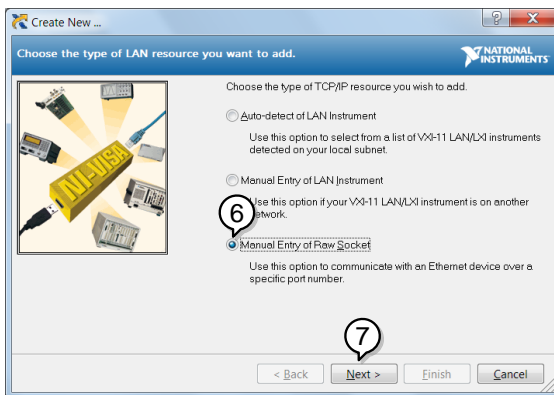

8. Enter the GDS-2000E's IP address and socket port number.
9. Click *Validate*.
10. A popup will appear to tell you if a VISA socket session was successfully created.
11. Click *Next*.

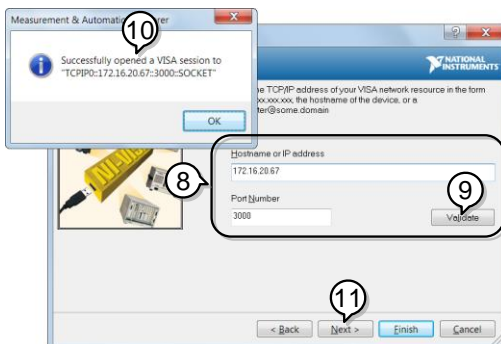

12. Choose an alias for the socket connection if you like.
13. Click *Finish* to finish the configuration.



14. The GDS-2000E will now appear under Network Devices in the Configuration Panel.

Functionality
Check

15. Click the *Open Visa Test Panel* to send a remote command to the GDS-2000E.

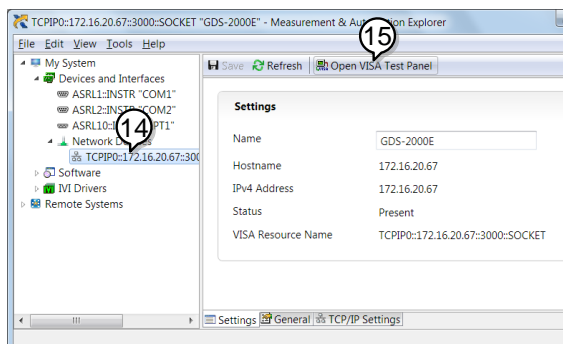

16. Click on the *Configuration* icon.
17. Select the *I/O Settings* tab.
18. Mark the *Enable Termination Character* checkbox.
Make sure the termination character is a line feed (/n, value: xA).
19. Click *Apply Changes*.

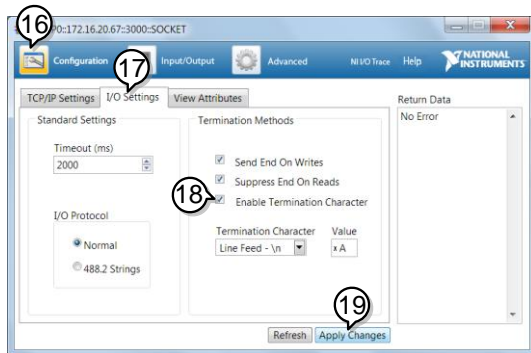

20. Click the *Input/Output* icon.
21. Make sure the **IDN?* query is selected in the *Select or Enter Command* drop box.
22. Click on *Query*.
23. The manufacturer, model number, serial number and firmware version will be displayed in the buffer. For example:
 GW,GDS-2202E,PXXXXXX,V1.00

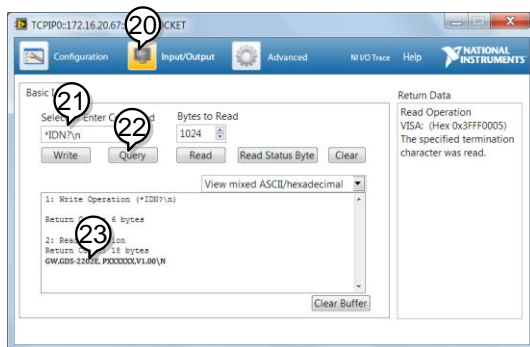

Note

For further details about remote control and remote commands, please see the GDS-2000E programming manual.



M AINTENANCE

Two types of maintenance operations are available: calibrate vertical accuracy, and compensate the probe. Run these operations when using the GDS-2000E in a new environment.

How to use SPC function	262
Vertical Accuracy Calibration	263
Probe Compensation	264

How to use SPC function

Background Signal Path Compensation (SPC) is used to compensate the internal signal path due to ambient temperature. SPC is able to optimize the accuracy of the oscilloscope with respect to the ambient temperature.

- Panel Operation**
1. Press the *Utility* key. 
 2. Press *System* from the bottom menu. 
 3. Press *SPC* from the side menu. A message showing a brief introduction to SPC appears on the screen. 





Note

Disconnect all probes and cables from all channels before calibrating.

The DSO needs to be warmed up for at least 30 minutes before using the SPC function.

4. Press *Start* on the side menu to start SPC calibration. 
5. The SPC Calibration will proceed one channel at a time, from channel 1 to channel 4.

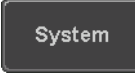
Vertical Accuracy Calibration

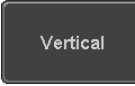
- Panel Operation
1. Press the *Utility* key. 
 2. Press *System* from the bottom menu. 
 3. Press *more 1 of 3* from the side menu. 
 4. Press *Self Cal* on the side menu. 
 5. Press *Vertical* on the side menu. 
 6. A message appears to “Now performing vertical calibration...
CH1
Connect the CAL output to channel, then press the Vertical key”.
 7. Connect the calibration signal from the rear panel to the Channel 1 input with a BNC cable.

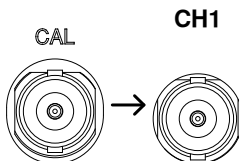

8. Press *Vertical* again after connecting CAL to the channel 1 input.

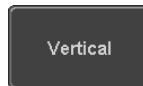

The calibration for Channel 1 starts and ends automatically, in less than 5 minutes. A message is displayed when the calibration procedure has ended.

9. Repeat the above step for Channel 2, 3* and 4* when prompted.

*4 channel models only.

10. When the calibration for all channels has completed, the display goes back to the default state.

Probe Compensation

- Panel Operation
1. Connect the probe between the Channel 1 input and the probe compensation output (default set as 2V_{p-p}, 1kHz square wave) on the front panel. Set the probe attenuation to x10.
 2. Alternatively, the probe compensation frequency can be changed. See page 188 for details.

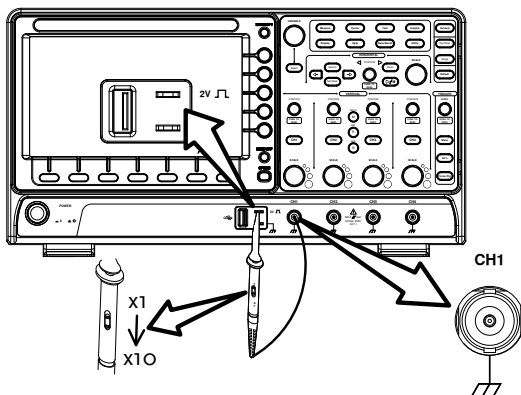

3. Press the *CH1* key to activate CH1.



4. Set the *Coupling* to DC from the bottom menu.

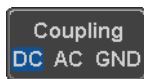

5. Set the Probe attenuation to *Voltage, 10X*.

Page 119

6. Press the *Autoset* key. The compensation signal appears on the display.



7. Press the *Display* key, then set the display type to *Vector*.

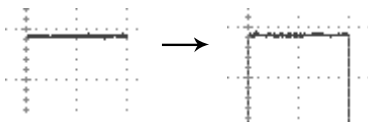
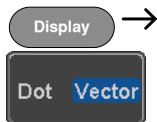

- Turn the adjustment point on the probe to make the waveform as square as possible.

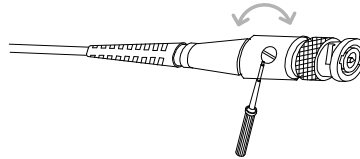
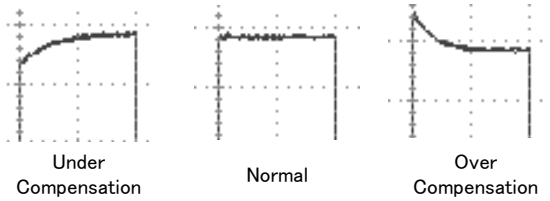

F AQ

- I connected the signal but it does not appear on the display.
- I want to remove the (Measurement result / FFT result / Help contents) from the display.
- The waveform does not update (frozen).
- The probe waveform is distorted.
- Autoset does not catch the signal well.
- The display image printout is too dark on the background.
- The date and time settings are not correct.
- The accuracy does not match the specification.

I connected the signal but it does not appear on the display.

Make sure you have activated the channel by pressing the Channel key (the channel key lights up).

I want to remove the (Measurement result / FFT result / Help contents) from the display.

To clear automatic measurement results, press the Measure key, select Remove Measurement and choose Remove All. See page 51.

To clear individual measurements from the screen, press the Measure key, select Display All and choose Off. See page 53.

To clear the FFT result, press the Math key twice. See page 67 for details.

To clear the Help result, press the Help key again. See page 36 for details.

The waveform does not update (frozen).

Press the Run/Stop key to unfreeze the waveform. See page 41 for details.

If this does not help, the trigger mode might be set to Single. Press the Single key to exit Single mode. See page 41 for Single trigger details.

The probe waveform is distorted.

You might need to compensate the probe. For details, see page 264.

Autoset does not catch the signal well.

The Autoset function cannot catch signals under 10mV or 20Hz. Please use the manual operation. See page 39 for Autoset details.

The display image printout is too dark on the background.

Use the Ink Saver function which reverses the background color. For details, see page 246.

The date and time settings are not correct.

For date and time setting details, please see page 187. If it does not help, the internal battery controlling the clock might be worn out. Contact your dealer or GW Instek.

The accuracy does not match the specification.

Make sure the device is powered On for at least 30 minutes, within +20°C~+30°C. This is necessary to stabilize the unit to match the specification.

For more information, contact your local dealer or GW Instek at www.gwinstek.com / marketing@goodwill.com.tw.

APPENDIX

GDS-2000E Specifications

The specifications apply when the GDS-2000E is powered on for at least 30 minutes under +20°C~+30°C.

Model-specific

GDS-2072E	Channels	2 + Ext
	Bandwidth	DC ~ 70MHz (-3dB)
	Rise Time	5ns
	Bandwidth Limit	20MHz
GDS-2074E	Channels	4
	Bandwidth	DC ~ 70MHz (-3dB)
	Rise Time	5ns
	Bandwidth Limit	20MHz
GDS-2102E	Channels	2 + Ext
	Bandwidth	DC ~ 100MHz (-3dB)
	Rise Time	3.5ns
	Bandwidth Limit	20MHz
GDS-2104E	Channels	4
	Bandwidth	DC ~ 100MHz (-3dB)
	Rise Time	3.5ns
	Bandwidth Limit	20MHz
GDS-2202E	Channels	2 + Ext
	Bandwidth	DC ~ 200MHz (-3dB)
	Rise Time	1.75ns
	Bandwidth Limit	20MHz/100MHz
GDS-2204E	Channels	4
	Bandwidth	DC ~ 200MHz (-3dB)
	Rise Time	1.75ns
	Bandwidth Limit	20MHz/100MHz

Common

Vertical Sensitivity	Resolution	8 bit :1mV*~10V/div *: When the vertical scale is set to 1mV/div, the bandwidth limit will be set to 20MHz automatically.	
	Input Coupling	AC, DC, GND	
	Input Impedance	1MΩ// 16pF approx.	
	DC Gain	±3% when 2mV/div or greater is selected.	
	Accuracy*	±5% when 1mV/div is selected.	
	Polarity	Normal & Invert	
	Maximum Input Voltage	300Vrms, CAT I(300Vrms CAT II with GTP-070A-4/150A-4/300A-4 10:1 probe	
	Offset Position Range	1mV/div ~ 20mV/div : ±0.5V 50mV/div ~ 200mV/div : ±5V 500mV/div ~ 2V/div : ±25V 5V/div ~ 10V/div : ±250V	
	Waveform Signal Process	+, -, x, ÷, FFT, FFTrms, User Defined Expression FFT: Spectral magnitude. Set FFT Vertical Scale to Linear RMS or dBV RMS, and FFT Window to Rectangular, Hamming, Hanning, or Blackman-Harris.	
	Trigger	Source	CH1, CH2, CH3*, CH4*, Line, EXT** *four channel models only. **two channel models only.
		Trigger Mode	Auto (supports Roll Mode for 100 ms/div and slower), Normal, Single Sequence
		Trigger Type	Edge, Pulse Width, Video, Pulse Runt, Rise & Fall, Timeout, Alternate, Event-Delay(1~65535 events), Time-Delay(Duration, 4nS~10S), Bus
		Holdoff range	4nS to 10S
Coupling Sensitivity		AC, DC, LF rej., Hf rej., Noise rej. 1div	
External Trigger	Range	±15V	
	Sensitivity	DC ~ 100MHz Approx. 100mV 100MHz ~ 200MHz Approx. 150mV	
	Input Impedance	1MΩ±3%~16pF	
Horizontal	Time base Range	1ns/div ~ 100s/div (1-2-5 increments)	
	Pre-trigger	ROLL: 100ms/div ~ 100s/div 10 div maximum	

	Post-trigger	2,000,000 div maximum.
	Timebase	±50 ppm over any ≥ 1 ms time interval
	Accuracy	
	Real Time	1GSa/s max. (4ch models);
	Sample Rate	1GSa/s per channel (2ch models)
	Record Length	Max. 10Mpts
	Acquisition Mode	Normal, Average, Peak Detect, Single
	Peak Detection	2nS (typical)
	Average	selectable from 2 to 256
X-Y Mode	X-Axis Input	Channel 1; Channel 3* *four channel models only
	Y-Axis Input	Channel 2; Channel 4* *four channel models only
	Phase Shift	±3° at 100kHz
Cursors and Measurement	Cursors	Amplitude, Time, Gating available; Unit:Seconds(s), Hz(1/s), Phase(degree), Ration(%).
	Automatic Measurement	36 sets: Pk-Pk, Max, Min, Amplitude, High, Low, Mean, Cycle Mean, RMS, Cycle RMS, Area, Cycle Area, ROVShoot, FOVShoot, RPREShoot, FPREShoot, Frequency, Period, RiseTime, FallTime, +Width, -Width, Duty Cycle, +Pulses, -Pulses, +Edges, -Edges, FRR, FRF, FFR, FFF, LRR, LRF, LFR, LFF, Phase.
	Cursors measurement	Voltage difference between cursors (ΔV) Time difference between cursors (ΔT)
	Auto counter	6 digits, range from 2Hz minimum to the rated bandwidth
Control Panel Function	Autoset	Single-button, automatic setup of all channels for vertical, horizontal and trigger systems, with undo Autoset
	Save Setup	20set
	Save Waveform	24set
Display	TFT LCD Type	8" TFT LCD WVGA color display
	Display Resolution	800 horizontal × 480 vertical pixels (WVGA)
	Interpolation	Sin(x)/x
	Waveform Display	Dots, vectors, variable persistence (16ms~4s), infinite persistence
	Waveform Update Rate	120,000 waveforms per second, maximum
	Display Graticule	8 x 10 divisions
	Display Mode	YT, XY

Interface	USB Port	USB 2.0 High-speed host port X1, USB High-speed 2.0 device port X1
	Ethernet Port	RJ-45 connector, 10/100Mbps with HP Auto-MDIX (LAN)
	Go-NoGo BNC	5V Max/10mA TTL open collector output
	Kensington Style Lock	Rear-panel security slot connects to standard Kensington-style lock.
	Miscellaneous	Multi-language menu
	Operation Environment	Temperature: 0°C to 50°C. Relative Humidity ≤ 80% at 40°C or below; ≤ 45% at 41°C ~ 50°C.
	On-line help	Available
	Time clock	Time and Date ,Provide the Date/Time for saved data
	Dimensions	380mmX208mmX127.3mm
	Weight	2.8kg

Probe Specifications

GTP-070A-4

Applicable to: GDS-2072E & GDS-2074E

Position x10	Attenuation Ratio	10:1
	Bandwidth	DC to 70MHz
	Input Resistance	10M Ω when used with oscilloscopes with 1M Ω input.
	Input Capacitance	28pF~32pF
	Max. Input Voltage	\leq 600Vpk, Derating with frequency
Position x1	Attenuation Ratio	1:1
	Bandwidth	DC to 6MHz
	Input Resistance	1M Ω when used with 1M Ω input
	Input Capacitance	120pF~220pF
	Max. Input Voltage	\leq 200Vpk, Derating with frequency
Operating Cond.	Temperature	-10°C ~ 50°C
	Relative Humidity	\leq 85%
Safety	EN61010-031 CAT II	

GTP-150A-4

Applicable to: GDS-2102E & GDS-2104E

Position X10	Attenuation Ratio	10:1
	Bandwidth	DC to 150MHz
	Input Resistance	10M Ω when used with oscilloscopes with 1M Ω input.
	Input Capacitance	8.5pF~18.5pF
	Compensation Range	5 to 30pF
	Max. Input Voltage	<600V DC + ACpk
Position X1	Attenuation Ratio	1:1
	Bandwidth	DC to 10MHz
	Input Resistance	1M Ω (Oscilloscope Input)
	Input Capacitance	45pF~65pF
	Max. Input Voltage	<200V DC + ACpk
Operating Cond.	Temperature	-10°C ~ 45°C
	Relative Humidity	\leq 85%

GTP-300A-4

Applicable to: GDS-2202E & GDS-2204E

Position X10	Attenuation Ratio	10:1
	Bandwidth	DC to 300MHz
	Input Resistance	10M Ω when used with oscilloscopes with 1M Ω input.
	Input Capacitance	8.5pF~18.5pF
	Compensation Range	5pF to 30pF
	Max. Input Voltage	<600V DC + ACpk
Position X1	Attenuation Ratio	1:1
	Bandwidth	DC to 10MHz
	Input Resistance	1M Ω (Oscilloscope Input)
	Input Capacitance	45pF~65pF
	Max. Input Voltage	<200V DC + ACpk
Operating Cond.	Temperature	-10°C ~ 45°C
	Relative Humidity	≤85%

GDS-2000E Dimensions

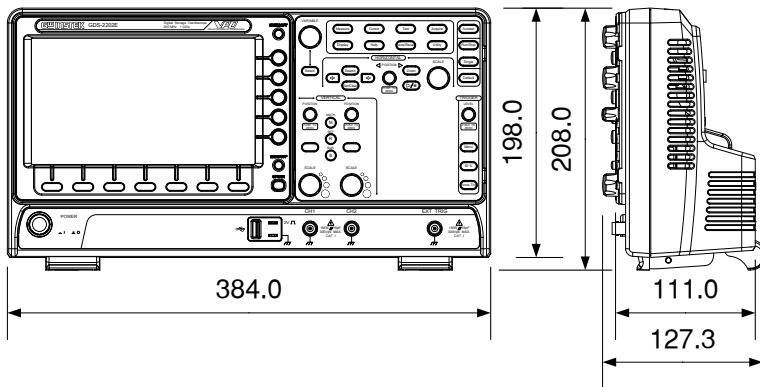
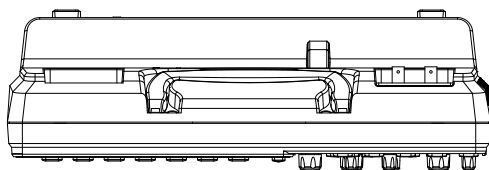

Declaration of Conformity

We

GOOD WILL INSTRUMENT CO., LTD.

No. 7-1, Jhongsing Rd, Tucheng Dist., New Taipei City 236. Taiwan.

GOOD WILL INSTRUMENT (SUZHOU) CO., LTD.

No. 69 Lushan Road, Suzhou New District Jiangsu, China.

declare that the below mentioned product

Type of Product: **Digital Storage Oscilloscope**

Model Number: **GDS-2072E, GDS-2074E, GDS-2102E, GDS-2104E,
GDS-2202E, GDS-2204E**

are herewith confirmed to comply with the requirements set out in the Council Directive on the Approximation of the Law of Member States relating to Electromagnetic Compatibility (2004/108/EC) and Low Voltage Directive (2006/95/EC).

For the evaluation regarding the Electromagnetic Compatibility and Low Voltage Directive, the following standards were applied:

© EMC	
EN 61326-1: EN 61326-2-1:	Electrical equipment for measurement, control and laboratory use -- EMC requirements (2013)
Conducted & Radiated Emission EN 55011: 2009+A1: 2010	Electrostatic Discharge EN 61000-4-2: 2009
Current Harmonics EN 61000-3-2: 2006+A1: 2009+A2: 2009	Radiated Immunity EN 61000-4-3: 2006+A1: 2008 +A2: 2010
Voltage Fluctuations EN 61000-3-3: 2013	Electrical Fast Transients IEC 61000-4-4: 2012
-----	Surge Immunity EN 61000-4-5: 2006
-----	Conducted Susceptibility EN 61000-4-6: 2009
-----	Power Frequency Magnetic Field EN 61000-4-8: 2010
-----	Voltage Dip/ Interruption EN 61000-4-11: 2004

Low Voltage Equipment Directive 2006/95/EC	
Safety Requirements	EN 61010-1: 2010 (Third Edition) EN 61010-2-030: 2010 (First Edition)

INDEX

2-4 channel differences	11	exception.....	40
AC coupling.....	114	Fit Screen mode	40
AC Priority mode	40	Bandwidth filter.....	116
Acquisition	80	Blackman window.....	70
average	80	Built-in help.....	36
indicator	26	Caution symbol.....	5
peak detect.....	80	Channel	38
record length.....	84	status indicator	26
sample	80	Cleaning the instrument	7
XY mode.....	82	Control panel function	
Advanced math		specification.....	272
expression.....	72	Conventions	31
operation.....	73	Coupling mode	114
source	72	Cursor	
Amplitude measurements.....	46	horizontal.....	59
APP		specification.....	272
Data Log.....	200	vertical.....	63
Demo	207	Data logging	200
Digital filter	202	Date setting.....	187
DVM	198	indicator	25
Go-NoGo.....	193	DC coupling	114
overview	191	Declaration of conformity.....	277
Remote disk.....	204	Default setup	231
run.....	192	contents	231
Area measurements	46	effect on channel.....	39
Auto trigger.....	147	Delay measurements.....	48
Auto-dim.....	101	Demo App	207
Automatic measurement		Deskew.....	119
Add measurement.....	49	digital filter	202
display all.....	53	Dimensions	
gated mode.....	52	diagram.....	276
High-Low.....	54	Display	
overview	45	Bus	121
Reference levels	58	diagram.....	25
remove measurement	51	search.....	176
Statistics	55	segmented memory	87
Autoset.....	39	specification.....	272
AC Priority mode	40	Disposal instructions.....	8
effect on channel.....	40		

- Dots..... 98
- DVM..... 198
- Edge Trigger..... 152
- EN61010
 - measurement category 6
 - pollution degree..... 7
- Environment
 - safety instruction 7
- Erase memory 186
- Ethernet
 - interface..... 252
- Event table format 139
- Expand by ground/center..... 117
- External trigger 146
 - input terminal 21
 - specification..... 271
- FAQ 267
- FFT
 - horizontal cursor 61
 - vertical cursor 64
- File
 - create folder..... 241
 - delete 243
 - rename..... 242
- File navigation..... 239
- File path 240
- Firmware version..... 186
- First time use 29
- Fit Screen mode..... 40
- Frequency measurements 47
- Front panel diagram..... 15
- Go-NoGo
 - circuit diagram..... 197
- Go-NoGo..... 193
 - timing 197
- Ground
 - coupling 115
 - symbol 5
 - terminal 22
- Hamming window 70
- Hanning window..... 69
- Holdoff..... 151
- Horizontal
 - basic operation..... 42
 - position..... 104
 - scale 105
 - specification..... 271
- Image file format 214
- Impedance..... 115
- Initialization..... 29
- Input frequency indicator 26
- Intensity..... 99
- Interface..... 250
 - specification..... 273
- Invert waveform 115
- Keys overview 16
- Labels..... 219
- Language selection 185
- List of features 12
- Math
 - Advanced math overview..... 72
 - basic 67
 - FFT operation..... 70
 - FFT overview 69
- Mean measurements..... 46
- Memory bar
 - indicator 26
- Menu on/off 103
- Miscellaneous
 - specification..... 273
- Model difference 11
- Normal trigger..... 147
- NTSC 149
- On-screen help 36
- Overshoot measurements 46
- PAL 149
- Peak measurements 45
- Peak to peak measurement..... 45
- Persistence..... 99
- Play waveform 110
- Power on/off
 - safety instruction 7
- Printing
 - connection..... 245
 - Hardcopy key..... 246
 - ink saver..... 246
- Probe
 - attenuation level 119
 - attenuation type..... 118
 - deskew 119
- Probe compensation 264
- Probe compensation frequency 188

Pulse runt trigger.....	158	play back.....	91
Pulse measurements	47	run.....	89
Pulse width trigger.....	155	statistics.....	93
QR code reader function.....	188	Serial bus	
Rear panel diagram.....	23	cursors	142
Recall.....	230	encoding.....	132
default setup.....	231	event tables.....	135
reference.....	236	labels.....	140
setup	234	overview	123
waveform.....	233	threshold.....	133
Rectangular window.....	70	trigger settings	
Reduce any menu	35	CAN.....	170
Reduce lower menu	34	I ² C.....	164
Reduce side menu	34	LIN.....	173
Remote control.....	249	mode.....	175
interface configuration	250	SPI.....	168
Remote disk.....	204	UART.....	163
Rise and fall trigger.....	160	Serial Bus	123
RMS measurements	46	CAN.....	130
Roll mode	106	I ² C.....	127
RS-232C		LIN.....	131
function check	251	SPI.....	128
Run/Stop.....	41, 103	UART.....	125
horizontal position	104	Serial number.....	186
Horizontal scale	105	Service operation	
Save	222	about disassembly.....	6
Hardcopy key.....	247	contact	269
image	223	Setup	
setup	228	default contents	231
waveform.....	226	file format	217
Screen dimmer.....	101	Signal path compensation	262
Search		Single trigger mode.....	147
configuration.....	176	Run/Stop.....	41
copying search events.....	178	Socket server	
copying trigger events.....	178	function check.....	255
FFT Peak.....	181	Socket server	
navigation	178	interface.....	254
save marks	179	SPC	262
set/clear events.....	180	Specifications.....	270
SECAM.....	149	Spreadsheet file format	215
Segmented memory		Stop icon	41
configuration.....	88	System information	186
information	97	Tilt stand	27
list.....	93	Time setting.....	187
measurement.....	93	indicator.....	25
navigation.....	91	Trigger.....	144
overview	85	Bus	
		CAN.....	170

I ² C.....	164	Vertical	113
LIN.....	173	accuracy calibration	263
SPI.....	168	basic operation.....	44
UART.....	163	position.....	113
edge.....	152	scale	114
holdoff.....	151	specification.....	271
indicator	26	Video trigger.....	157
mode.....	152	Warning symbol.....	5
parameters.....	146	Waveform	
pulse runt.....	158	CSV file contents.....	216
pulse width.....	155	file contents	215
Rise and fall	160	how to recall.....	233
Single	41	how to save.....	226
specification.....	271	invert waveform	115
status indicator	26	play/pause key.....	110
Timeout.....	161	roll mode.....	106
overview	150	zoom mode.....	107
video	157	Waveform color.....	25
UK power cord.....	9	Waveform file format	214
USB		XY	
function check.....	251	specification.....	272
remote control interface	250	Zoom waveform.....	107
Vectors.....	98		