

Signet 2760 DryLoc® pH/ORP Preamplifiers

(Not for new designs or installations)



In-line
2760



Submersible
2760

DryLoc® Electrodes sold separately.

The Signet 2760 pH/ORP Preamplifiers feature a DryLoc® connector, providing a robust connection to Signet DryLoc electrodes.

The 2760 preamplifier allows DryLoc pH/ORP electrodes to work with Signet ProcessPro® and ProPoint® pH/ORP instruments.

The DryLoc electrode connector system quickly forms a robust assembly for submersible and in-line installations. Optional NEMA 4X junction enclosures extend the preamplifier cable to long distances.

The 2760 submersible preamplifier can also be used as an in-line preamplifier when used with the ¾ in. or 1 in. threaded sensors including the 2724, 2774 and 2764 series electrodes. The 2760 in-line preamplifier can be used with Signet fittings up to DN100 (4 in.) and Wet-Tap assemblies.

The 2760 pH/ORP preamplifiers are compatible with the Signet 8750 and older analog transmitters. The 8900 and 9900 instruments and Profibus Concentrator require the use of the 2751 Smart Sensor Electronics, and are not compatible with the 2760 preamplifier.

Features

- In-line integral mount and submersible installation versions
- Compatible with pH or ORP sensors
- Patented DryLoc® connector provides a quick and secure connection to the sensor*



Applications

- Water/Wastewater Treatment
- Neutralization Systems
- Scrubber Control
- Effluent Monitoring
- Surface Finishing
- Flocculent Coagulation
- Heavy Metal Removal and Recovery
- Toxic Destruction
- Sanitization Systems
- Pool & Spa Control
- Aquatic Animal Life Support Systems

*U.S. Patent No.: 6,666,701

Specifications

General			
Compatible Electrodes	Signet DryLoc pH and ORP Electrodes Models 2724-2726, 2756-2757 Wet-Tap, 2764-2767, 2774-2777		
	All pH sensors used with the 2760/8750 must have a 3K Temperature sensor		
Compatible Instruments	8750 and 5700		
Operating Range	pH	0 to 14 pH	
	ORP	±2,000 mV	
Response Time*	pH	< 6 sec. for 95% of change	
	ORP	application dependent	
Materials	In-line	Valox® (PBT)	
	Submersible	CPVC	
Electrical			
Cable	4.6 m (15 ft) supplied, 120 m (400 ft) max		
	6 cond., foil shield with drain wire, 24 AWG		
Max. Temperature/Pressure Rating			
Operating Temperature	Submersible	0 °C to 85 °C	32 °F to 185 °F
	In-line	0 °C to 110 °C	32 °F to 230 °F
Storage Temperature	-20 °C to 85 °C	-4 °F to 185 °F	
Relative Humidity	0 to 95%, non-condensing (without electrode connected)		
Environmental			
Enclosure	Submersible	NEMA 6P/IP68 with electrode and watertight conduit and/or extension pipe connected	
	In-line	NEMA 4 with electrode and watertight conduit and/or extension pipe connected	
Shipping Weight			
	0.64 kg	1.41 lb	
Standards and Approvals			
	CE, FCC		
	RoHS compliant, China RoHS		
	Manufactured under ISO 9001 for Quality and ISO 14001 for Environmental Management and OHSAS 18001 for Occupational Health and Safety		

Dimensions



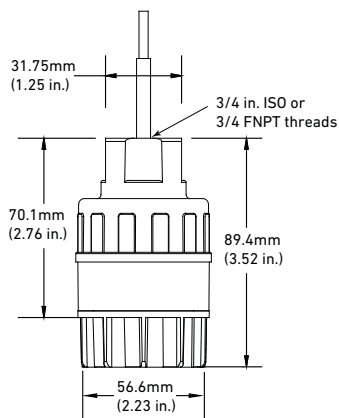

3-2760-1, -2

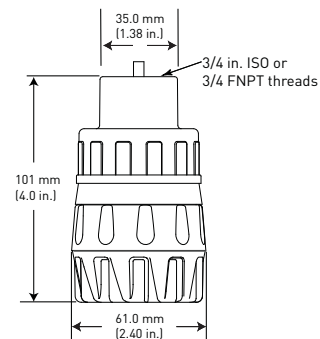

3-2760-11, -21

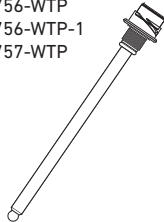
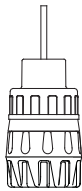
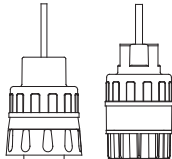
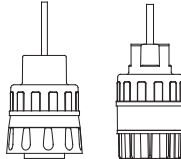
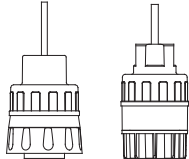

2760 Product Selection Guide

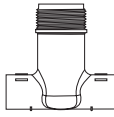
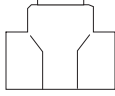
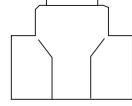
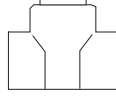
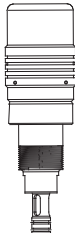
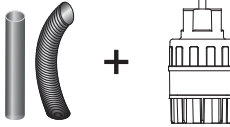
1. Choose the Electrode	2724-2726 3-2724-10,-11 3-2724-HF-10,-11 3-2725-60,-61 3-2726-10,-11 3-2726-HF-10,-11 3-2726-LC-10,-11 		2764-2767 Differential 3-2764-1 3-2765-1 3-2766-1 3-2767-1 		2774-2777 3-2774 3-2775 3-2776 3-2777 		2756 and 2757 Wet-Tap 3-2756-WTP 3-2756-WTP-1 3-2757-WTP 			
2. Determine the mounting style:	In-line  2760-11 or -21		In-line  2760-11 or -21 2760-1 or -2		In-line  2760-11 or -21 2760-1 or -2		In-line  2760-11 or -21 2760-1 or -2		In-line  2760-11 or -21	
And -In-line fitting Or	 Signet fitting		 3/4" reducing tee		 1" reducing threaded tee		 3/4" reducing tee		 3719 Wet-Tap Assembly	
Submersible	2760-1 or -2 and cable conduit (customer supplied) connected to 3/4" sensor electronics				(Submersible not applicable with Wet-Tap assembly)					

Model 2760 Ordering Information

- 1) Conduit and mounting brackets for submersion installation must always be used (customer supplied).
- 2) The 3-2759 System Tester must be ordered with the adapter cable 3-2759.391 for exclusive use with the 2760.
- 3) All sensor preamplifiers require a DryLoc electrode for full system installation.
- 4) Use Models 2724-2726, 2756-WT, 2757-WT, 2764-2767 and 2774-2777 pH and ORP electrodes with the 2760.

Application Tips

- The EasyCal feature automatically recognizes standard 4.0, 7.0, and 10.0 pH buffer or ORP Quinhydrone solutions of 87 and 264 mV and simplifies calibration
- Frequency of calibration of electrodes is dependent upon the application.

Ordering Information

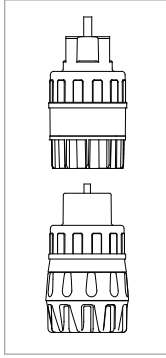

Mfr. Part No.	Code	Description
Submersible pH/ORP Preamplifier (gray body) for use with the 8750 instrument		
3-2760-1	159 000 939	¾ in. NPT threads and 4.6 m (15 ft) cable
3-2760-2	159 000 940	¾ in. ISO threads and 4.6 m (15 ft) cable
In-line pH/ORP Preamplifier (yellow body); use with Signet fittings or Wet-Tap sensors and other manufacturer's instruments		
3-2760-11	159 001 367	¾ in. NPT threads and 4.6 m (15 ft) cable
3-2760-21	159 001 368	with ¾ in. ISO threads and 4.6 m (15 ft) cable

Accessories and Replacement Parts

Mfr. Part No.	Code	Description
Calibration		
3-2700.395	159 001 605	Calibration kit: includes 3 polypropylene cups, box used as cup stand, 1 pint pH 4.01, 1 pint pH 7.00)
3822-7115	159 001 606	20 gm bottle quinhydrone for ORP calibration (must use pH 4.01 and/or pH 7.00 buffer solutions)
3-2759	159 000 762	pH/ORP system tester (adapter cable sold separately)
3-2759.391	159 000 764	2759 adapter cable for use with 2750 and 2760 DryLoc® sensor electronics
3-0700.390	198 864 403	pH buffer kit (1 each 4, 7, 10 pH buffer in powder form, makes 50 ml of each)
3822-7004	159 001 581	pH 4 buffer solution, 1 pint (473 ml) bottle
3822-7007	159 001 582	pH 7 buffer solution, 1 pint (473 ml) bottle
3822-7010	159 001 583	pH 10 buffer solution, 1 pint (473 ml) bottle
Other		
5523-0624	159 000 636	Cable, 6-cond. plus shield, 24 AWG, black/red/white (for use with 2760, orders must specify length per foot)
3-8050	159 000 184	Universal mounting kit
3-8050.390-1	159 001 702	Retaining nut replacement kit, Valox K4530

Contact:
 Industrial Process Measurement, Inc.
 3910 Park Avenue, Unit 7
 Edison, NJ 08820
 732-632-6400
 support@instrumentation2000.com
<http://www.instrumentation2000.com>