

YC-7XXUD series thermometer
K/J/T/E/R/S/N Types
Users Manual



Table of Contents

● Introduction	_____	1
● Features	_____	2
● General specifications	_____	3
● Electrical specifications	_____	4
● Names of parts	_____	5
● Operation	_____	6
● Battery replacement	_____	16
● Caution	_____	17

■ Introduction

Thank you for purchasing the temperature gauge from us. Please take a few minutes to browse through this user manual before you begin to operate the unit to ensure that you are fully familiarized with how best to operate the temperature as accurately and safely as possible.

The YC-7xx serial temperature gauges features a microprocessor-based digital temperature gauge, which according to varied input configurations and different thermocouple types, is divided into 48 modes, refer to the table below for a concise summary of subtle distinctions in their designed functions.

■ Features

1. The maximum displays for four temp. values.
2. Resolution 0.1°C/0.1°F, 1°C/1°F.
3. Swift response.
4. Setting alert temperature range.
5. With auto power off function.
6. With low battery indicator function.
7. With a perpetual calendar function.
8. With "COUNT" function.
9. With T1~T4 exchange to main display function.
(for above dual channel modes)
10. With T1-T2 function.(for dual channel modes),
T3-T4 function(for four channel).
11. Additional features include: HOLD, °C/°F/K,
REL, CHAN, MAX/MIN/AVG, 1, TYPE, TIME
(CLOCK setting), LIMIT(Hi/Lo setting).
12. CE certified, according to ITS-90 law.

■ General Specifications

1. Display Mode: Four-digit liquid crystal display.
2. Polarity indicator: No indicator is shown when readouts are in the positive value, while the symbol "-" is prompted when readouts fall into the negative value.
3. Overload indicator: The "OL" or "-OL" indicator.
4. Low-battery indicator: The symbol "B" is prompted on the LCD when the battery runs low.
5. Power source: Four DC-1.5V/UM-4 batteries.
6. Auto power off: The unit no operations are over 20-minute, the battery power will be turned off. Press the "Shift" key for 3 seconds, the auto power off will be cancelled.
7. Sample rate: 1 time/sec.
8. Battery life: Approx. 550 hours.
9. Operating Temperature and Humidity:
0°C~50°C (32°F~122°F), 0~80%RH.
10. Storage Temperature and Humidity:
-20°C~60°C (-4°F~140°F), 0~80%RH.
11. Dimension: 164x76x32mm(LxWxH).
12. Weight: Approx. 415g(include batteries).
13. Accessories:
 - (A) DC-1.5V/UM-4(4pcs).
 - (B) Housing(1pcs).
 - (C) K-type thermocouple wire.
(single channel x1pcs,
for above dual channel x2pcs).
 - (D) Users manual(1pcs).

■ Electrical Specifications

1.Temp.unit: Celsius temp.(°C). Fahrenheit temp.
(°F).Absolute temp.(K).

2.Measurement Range:(At $23 \pm 5^{\circ}\text{C}$, <80%RH)

K-type:-100°C~1300°C(-148°F~2372°F)

J-type:-100°C~1000°C(-148°F~1832°F)

T-type:-100°C~400°C(-148°F~752°F)

E-type:-50°C~800°C(-58°F~1472°F)

R&S-type:0°C~1700°C(32°F~ 3092°F)

N-type:-100°C~1300°C(-148°F~2372°F)

3. Accuracy: The basic accuracy does not include
the error of the thermocouple.

K/J/T/E/-type:

$\pm(0.1\% \text{ reading} + 0.7^{\circ}\text{C})$ -100°C~1300°C

$\pm(0.1\% \text{ reading} + 1.4^{\circ}\text{F})$ -148°F~2372°F

R/S-type:

$\pm(0.1\% \text{ reading} + 2^{\circ}\text{C})$ 0°C~1700°C

$\pm(0.1\% \text{ reading} + 4^{\circ}\text{F})$ 32°F~3092°F

N-type:

$\pm(0.1\% \text{ reading} + 1.5^{\circ}\text{C})$ -100°C~1300°C

$\pm(0.1\% \text{ reading} + 3^{\circ}\text{F})$ -148°F~2372°F

4.Resolution:

	1°C	0.1°C
K	-100°C~1300°C	-100°C~200°C
J	-100°C~1000°C	-100°C~150°C
T	-100°C~400°C	-100°C~150°C
E	-50°C~800°C	-50°C~100°C
R	0°C~1700°C	
S	0°C~1700°C	
N	-100°C~1300°C	-100°C~150°C

■ Names Of Parts



1.LCD display

2.Function control key

3.Thermocouple input jack

4.Battery cover

5.USB input jack

6.Shift button

7.Power button

■ Operation

1. Ⓞ: Power ON/OFF key.

Press the power button to turn the power ON or OFF.

2. °C / °F / K: The temperature Unit selection key.

Press the key to sequentially alternate the three temp. unit of °C, °F and K.

3. HOLD: The readout hold function key.

Press the "HOLD" key, a "HOLD" icon will display on the LCD and the readout held in; press the "HOLD" key once more to cancel the "HOLD" function.

4. MAX/MIN/AVG: The maximum/minimum/average readout function key

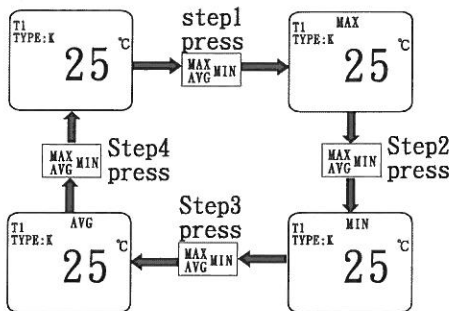

■ Operation

5. REL: The minus relative readout function key.

Press the "REL" key, a "REL" icon will display on the LCD and the original of a temp. will become to 0, and save the original temp. to make a standard value. Whenever the input temp. shifts, the LCD will show the minus value of original temp. value and input temp. Value.

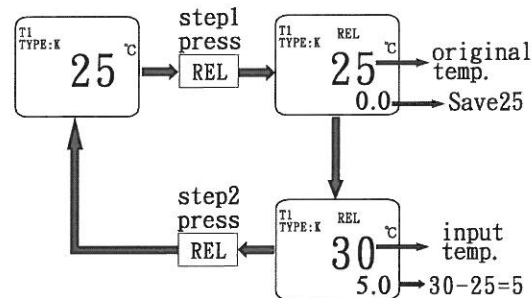

6. 1 : f or 0.1 unit selection function key.

Press the "1" key, the whole resolution will become 1°C / 1°F, and no dot. Press the key once more, the display will restore common state (the resolution will become 0.1°C / 0.1°F).

P.S: The resolution of the thermocouple types is shown in page 4.

■ Operation

7.CHAN:every input temp. value changed to main display function key.(for above dual channel modes)

A.dual channel

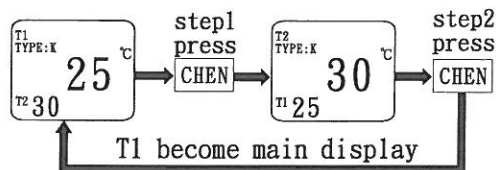

B.triple channel

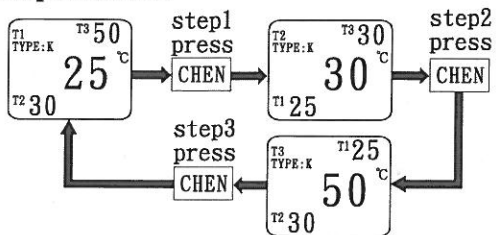

C.four channel

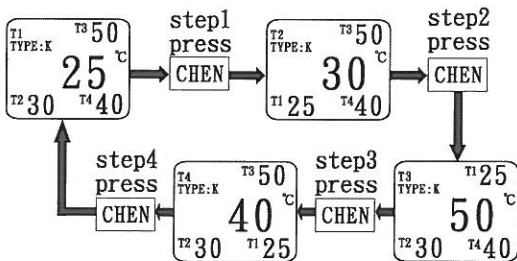

■ Operation

8.TYPE:select thermocouple type function key. YC-7XXUD series according to different modes, there are seven types in all. Other modes can be selected by users besides YC-71XUD, YC-72XUD, YC-73XUD, YC-74XUD. The method of operation as follows:

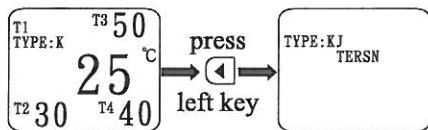

- A. Use \leftarrow , \rightarrow key to choose "type".
- B. The word will flicker for the chosen "type".
- C. To confirm it, then press "SHIFT" key.

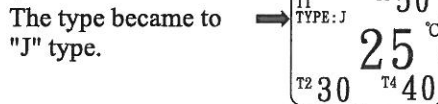

■ Operation

9.COUNT: The count time setting function key.
The max count time is 99 hours and 59 minutes.

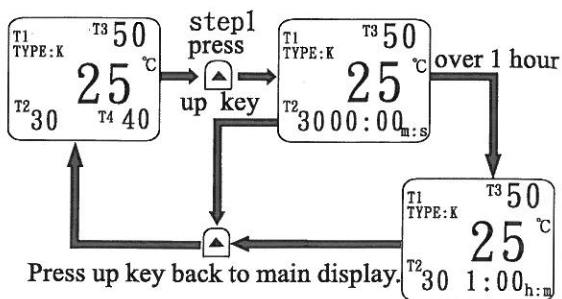

10.TIME: To see the present time function key.

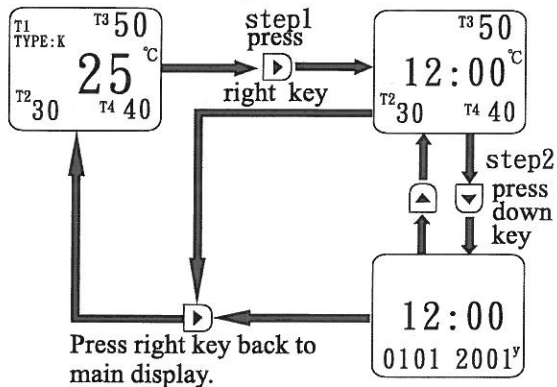

■ Operation

11.T1-T2: for above dual channel modes.

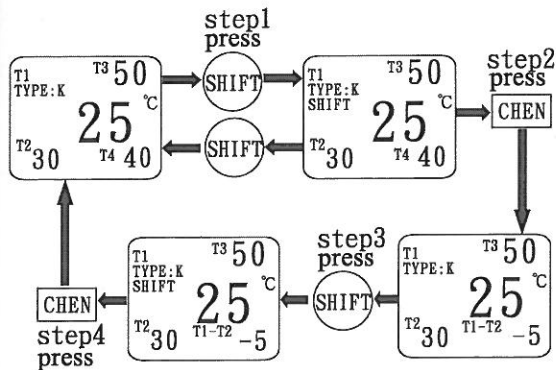

12.T3-T4: for four channel modes.

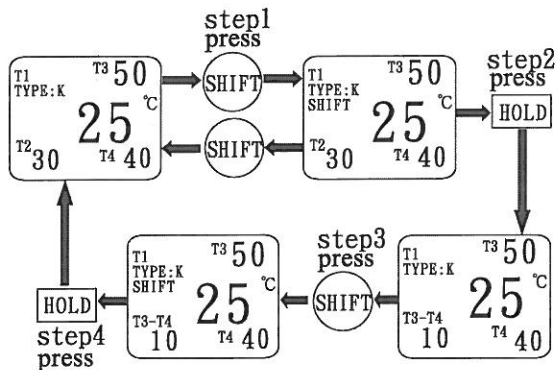

■ Operation

13.LIMIT:To enforce alarm function key.

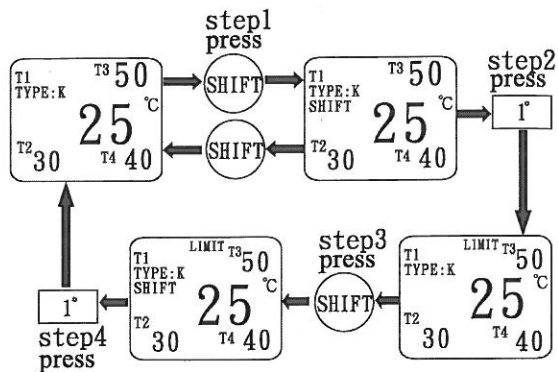

P.S1:When the main display temp.value is higher than the alarm setting Hi temp.value or lower than the alarm Lo setting temp.value, the alarm will continue send out.

2:The Hi/Lo setting temp. Value of the thermocouple types are different.

Type Hi/Lo	Hi	Lo
K	1300	-99.9
J	1000	-99.9
T	400	-99.9
E	800	-50
R	1700	0
S	1700	0
N	1300	-99.9

■ Operation

14.Hi/Lo:The alarm Hi/Lo temp.value setting.

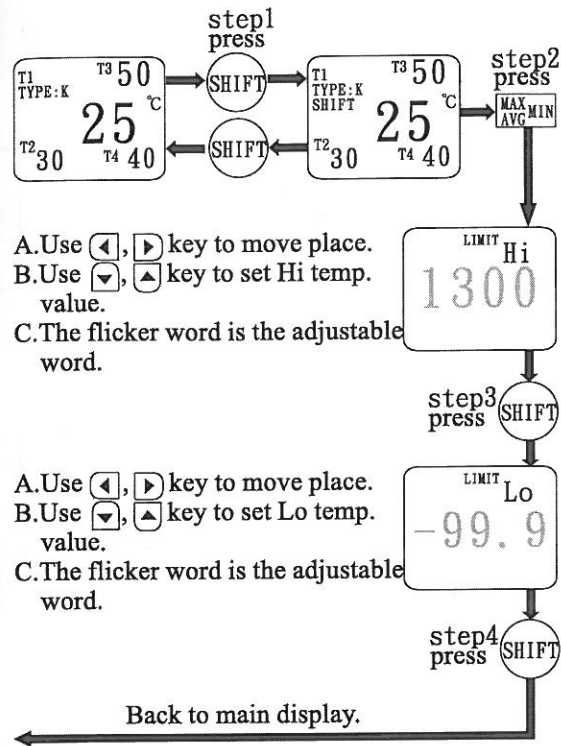

- A. Use , key to move place.
- B. Use , key to set Hi temp. value.
- C. The flicker word is the adjustable word.

- A. Use , key to move place.
- B. Use , key to set Lo temp. value.
- C. The flicker word is the adjustable word.

Back to main display.

■ Operation

15. CLOCK: To enforce date setting function key.

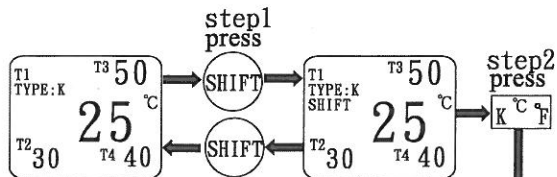

- Use , key to move place.
- Use , key to set hour & minute.
- The flicker word is the adjustable word.

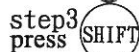
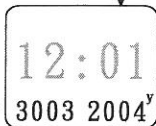

- Use , key to move place.
- Use , key to set date & month.
- The flicker word is the adjustable word.

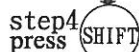
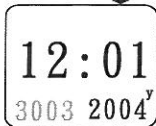

- Use , key to move place.
- Use , key to set year.
- The flicker word is the adjustable word.

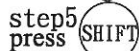
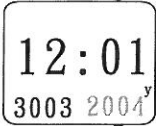

Back to main display.

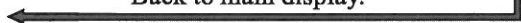

■ Operation

16. perpetual calendar:

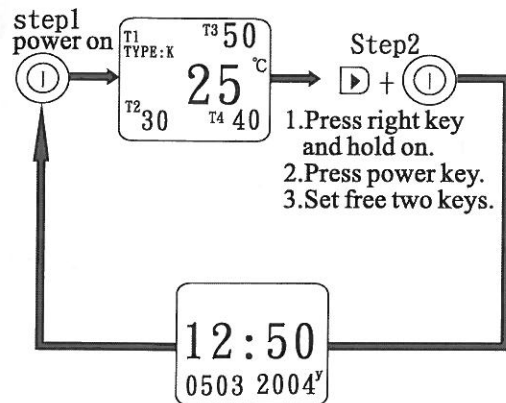

17. :backlight.(for option)

- Press the backlight button to turn the backlight ON or OFF.
- In no turn off backlight condition, the backlight function can keep on 1 minute.

■ Battery replacement

1. The symbol "**B**" that appears in the upper left of the LCD display indicates that the unit's battery is running low. Please replace the 1.5V battery at once to ensure the test accuracy.
2. Remove the battery cover by one screwdriver.
3. Replace the old battery with four new 1.5V batteries and lock the battery cover.
4. Prior to replacing the battery, please make certain to remove the thermocouple from the temperature gauge as a safety precaution.
5. When in extended idle, please remove the 1.5V battery from the temperature gauge and store the temperature gauge only in a cool and low-humidity setting.
6. To avoid combustion, DO NOT dispose of batteries in general into an open flame.
7. Caution the positive and negative polarity when loading battery.
8. Please abide by pertinent laws and regulations when disposing of used batteries.

■ Caution

1. **Input protection:** The temperature jack carried a maximum voltage of 24 volts DC or AC.
2. **Temperature jacks:** Design for the insertion of a standard small thermocouple jacks, which has a center spacing of 7.9mm between the two prongs.
3. Please DO NOT placed inside a microwave for temperature testing.
4. A correct thermocouple slot should be chosen when operating the temperature gauge.
5. Please DO NOT attempt to use a temperature gauge that is not working properly, for this may result in physical harms, send for repair service at once.
6. Please DO NOT attempt to operate the temperature gauge in the around sites where explosive gases, vapor or dust particles are present.
7. Please refrain from subject the paired thermocouple or the grounding between the thermocouples to a voltage exceeding what has been marked on the unit.
8. When gauge occur crashed, please take one battery out for above one minute. Then place the battery back and restart the gauge.

YC-7XXUD series thermometer K/J/T/E/R/S/N Types USB+Data Logger Users Manual



■ Operation

1.PC: Turn on "PC" function, the meter & PC application program communication. When turn on "PC" function, The auto power off will be canceled, and the power off will be canceled, too. For USB or Data Logger models.

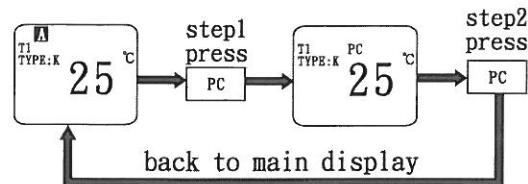

2.REC: Turn on REC function, the reading value of meter, according to transmitting the settlement of interval time, will write down in the memory real time. Can write down 10000 records at most. When turn on "REC" function, the auto power off will be canceled, and the power off will be canceled, too. When the memory is filled, the display will appeared "ou" word. For Data Logger models.

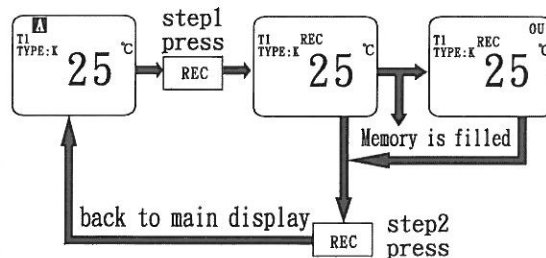

■ Operation

3.CALL: Can inquire that the data of every channel, can also inquire about the surplus space of the memory. For Data Logger models. Each time entering to inquire data by the last. When turn on "CALL" function, the auto power off will be canceled.

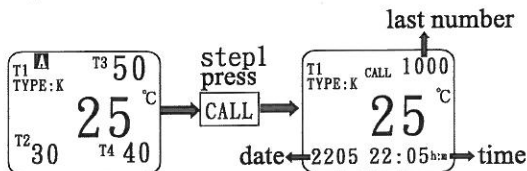

- A. Use \leftarrow , \rightarrow key to choose "channel".
 B. Use \downarrow , \uparrow key to choose "number". Hold \downarrow or \uparrow key above 1 second, the readout rate will be added. About 50 numbers/sec.

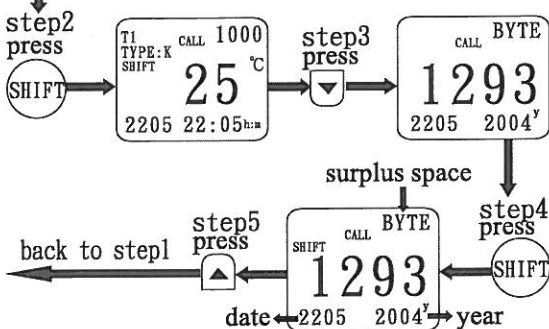

■ Operation

4. SHIFT + CALL: remove the record of the memory. For Data Logger models.

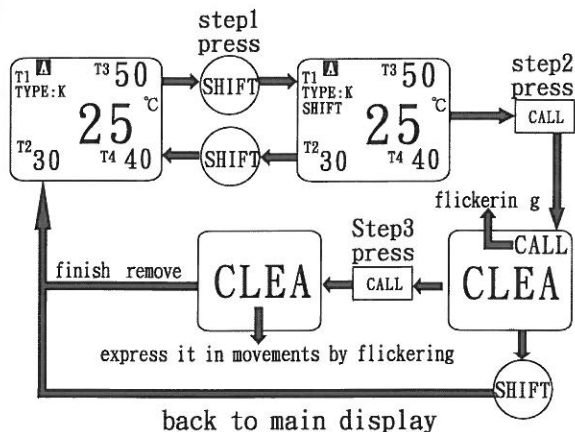

5. SHIFT + PC: Carry out the USB interval setting. The biggest settlement time is 59 minutes and 59 seconds. Minimum to set for time is one second. Enter and show 00:01 seconds of initial value for the first time. Enter and show settlement value last time for the second time after. For USB or Data Logger models.

6. **SHIFT** + **REC** : carry out the record interval

setting. The biggest settlement time is 59 minutes and 59 seconds. Minimum to set for time is one second. Enter and show 00:01 seconds of initial value for the first time. Enter and show settlement value last time after. For Data Logger models.

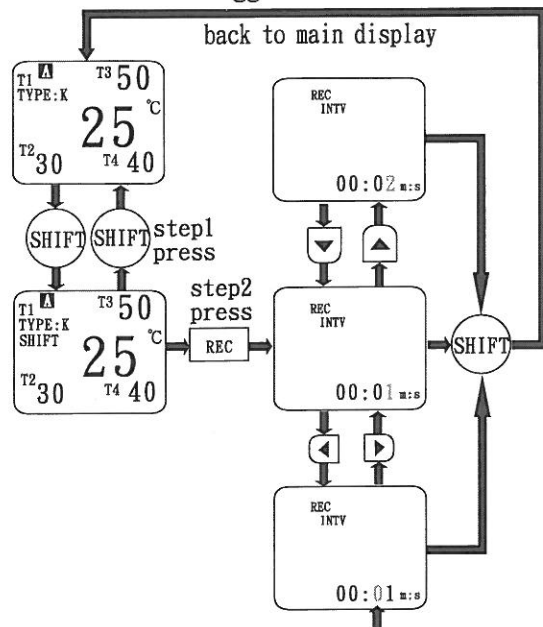

The flashing number represents adjustable number.

■ Operation

7. **SHIFT** + **PC** :

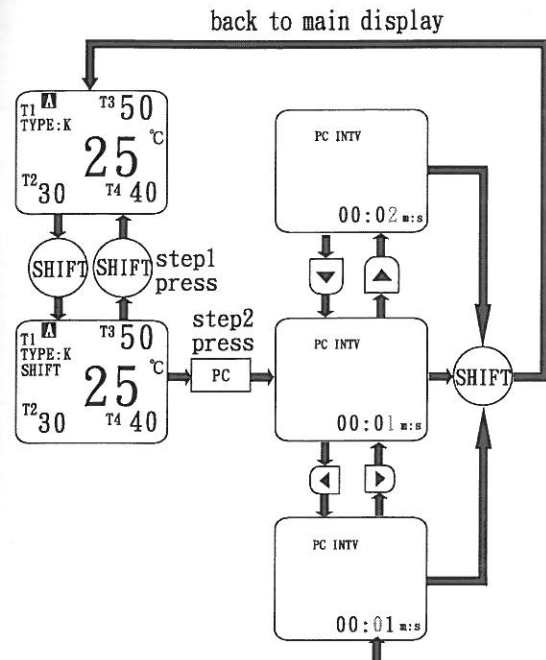

The flashing number represents adjustable number.