



Instruction Manual

PAPERLESS RECORDER

TYPE: PHU



PREFACE

Thank you for your purchasing Fuji Paperless Recorder (Type: PHU).

- Read this instruction manual carefully to ensure correct installation, operation and preparation. Incorrect handling may lead to accident or injury.
- Specifications of this unit are subject to change without prior notice for improvement.
- Modification of this unit without permission is strictly prohibited. Fuji will not be bear any responsibility for a trouble caused by such a modification.
- This instruction manual should be kept by the person who is actually using the unit.
- After reading the manual, be sure to keep it at a place easy to access.
- This instruction manual should be delivered to the end user without fail.

Manufacturer : Fuji Electric Instrumentation Co., Ltd.
Type : Shown on nameplate of Paperless Recorder
Date of manufacture : Shown on nameplate of Paperless Recorder
Product nationality : Japan

(Note) Windows 2000/XP, Excel, WORD PAD are registered trademarks of Microsoft Corporation.

(Note) Compact Flash is a trademark of SanDisk Corporation.

Request

- It is prohibited to transfer part or all of the manual without Fuji's permission.
- Description in this manual will be changed without prior notice.

© Fuji Electric Systems Co., Ltd. 2007



Issued in September, 2007

CAUTION ON SAFETY

Read this “Caution on Safety” carefully before using the instrument.

- Be sure to observe the instructions shown below, because they describe important information on safety. The degree of danger is classified into the following two levels: “DANGER” and “CAUTION.”

The signs and their meanings are as follows:

 DANGER	<p>Improper handling may cause dangerous situations that may result in death or severe injury.</p>
 CAUTION	<p>Improper handling may cause dangerous situations that may result in moderate or light injuries or property damage.</p>

 DANGER
<ul style="list-style-type: none"> • When there is a possibility that the abnormality of this instrument may cause a major accident or damage to other instruments, externally install an adequate emergency stop circuit or a protection circuit to prevent accidents. • This product is provided with a built-in fuse that cannot be replaced by the customer. Therefore, we recommend you to separately provide adequate fuses externally. (Rating: 250V, 2A) The details of the built-in fuse are as follows. Type: TR-5 19372, 3.15A (Manufactured by Wickmann-Werke GmbH) Rating: 250V, 3.15A, Type: T (Slow-blow type) • Feed the power-supply voltage to specifications to prevent damages to and breakdown of the instrument. • Never turn on the power before all the mounting and wiring work are finished to prevent electric shock, malfunction or failure of the instrument. • Never use this instrument in an environment where flammable or explosive gases exist, since this is not of intrinsically safe construction. • Never disassemble, remodel, modify, or repair this instrument. Otherwise malfunction, electric shock, or failure may result. • Never touch the terminal while the instrument is being energized. Otherwise electric shock or malfunction may result. • Turn off the power before attaching/detaching the module/unit. Otherwise electric shock, malfunction or failure may result. • We recommend you to perform periodic maintenance for the safe and continuous use of this instrument, because consumable parts or those which deteriorate with time are mounted in this instrument. • Do not block the ventilation holes at the top and the bottom of this instrument. Otherwise a failure, malfunction, shortened service life, or fire may result.

CAUTION

- Never use the instrument if it is found damaged or deformed when unpacked. Otherwise a fire, malfunction, or failure may result.
- Check that the instrument is to the proper specifications. Otherwise damage or failure may result.
- Do not give a shock to the instrument by falling or toppling it. Otherwise damage or failure may result.
- Operate the instrument paying attention to prevent foreign matters such as scraps, electric wire chips, and iron powder from entering in the instrument. Otherwise malfunction or failure may result.
- Check every six months that the terminal screws and mounting screws are securely fastened. Loose screws may cause fire, malfunction, or failure.
- When changing the setting during the operation or forcibly outputting, starting or stopping the instrument, be sure to check that safety is ensured. Improper operation may result in damage or failure of the instrument.
- Be sure to keep the attached terminal cover mounted on the terminal block during the operation. Otherwise electric shock or fire may result.
- Never install this instrument in the following environments.
 - A place where the ambient temperature goes beyond the range from 0 to 50°C (0 to 40°C when the instrument is provided with Ethernet function).
 - A place where the ambient humidity goes beyond the range from 20 to 80% RH
 - A place where condensation occurs
 - A place where corrosive gases (sulfuric gases or ammonia, etc., in particular) or flammable gases exist
 - A place where vibration or impact may be applied to the instrument (permissible continuous vibration condition: 4.9 m/s² or lower)
 - A place subjected to water, oil, chemicals, vapor, or steam
 - A place subjected to dust and high in salt or iron content
 - A place where inductive interference may have a great effect, thus causing static electricity, magnetism, or noises
 - A place subjected to heat accumulation by radiant heat or the likeIf the instrument is installed near other electronics instruments, such as TV in particular, noises may be caused. Take the following measures in these cases.
 - Place the instrument as far from the TV or the radio as possible (1m or more)
 - Change the orientation of the antenna of the TV or the radio.
 - Use separate receptacles.
- When mounting this instrument against the panel, pay attention not to apply stress to the case. Otherwise the case may be damaged.
- Stop using the instrument if it is immersed in water. Otherwise electric leak, electric shock, or fire may result.
- Do not use the wires other than the specified compensation conducting wires for the thermocouple input connection. Otherwise improper indication or malfunction may result.
- Use a wire material with low wire resistance and with small resistance difference among the three wires for the resistance bulb input connection. Otherwise improper indication or malfunction may result.

 **CAUTION**

- If a large noise is generated from the power supply, provide an isolating transformer and use a noise filter.
- Never use organic solvents such as alcohol or benzene when cleaning this instrument. Do not directly water the main unit. Otherwise deterioration, failure, electric leak, electric shock, or fire may result. When cleaning the main unit, wipe with a dry cloth.
- Dispose the instrument as an industrial waste.
- Be sure to ground the instrument. Otherwise electric shock or malfunction may result.
- Only authorized workers should perform wiring. Improper wiring may cause fire, failure, or electric shock.
- At this equipment, the electrostatic discharge is evaluated as performance criteria B in EN61326.
- This product contains a CR Coin Lithium Battery which contains Perchlorate Material-special handling may apply. See www.dtsc.ca.gov/hazardouswaste/perchlorate

CONTENTS

PREFACE.....	i
CAUTION ON SAFETY	ii
CONTENTS	v
1. INTRODUCTION	1-1
1.1 Paperless recorder	1-1
1.2 Product check.....	1-1
1.3 Check on type and specification.....	1-2
1.4 Handling memory card (Compact Flash)– Cautions on handling.....	1-2
1.5 Ethernet communication function.....	1-4
2. NAMES AND FUNCTIONS OF PARTS.....	2-1
2.1 Names and functions of parts.....	2-1
2.2 Inserting and removing the memory card	2-3
2.3 Recording data to memory card.....	2-4
3. MOUNTING METHOD.....	3-1
3.1 Mounting location.....	3-1
3.2 External dimensions and panel cutout dimensions (unit: mm)	3-1
3.3 How to mount the unit onto the panel.....	3-2
4. WIRING.....	4-1
4.1 Before wiring	4-1
4.2 Connection to terminals	4-2
4.3 Connecting recorder to loader.....	4-11
5. DISPLAY FUNCTION	5-1
5.1 Basic composition of Data Display screen	5-1
5.2 Real time trend display of measured data	5-2
5.3 Display of measured data in bar graphs or analog meters	5-4
5.4 Digital display of measured data.....	5-5
5.5 Totalizing data display	5-5
5.6 Event summary display	5-7
5.7 Ethernet log display	5-9
5.8 Historical trend display	5-10
5.9 Display on the occurrence of main unit failure.....	5-11
5.10 Cautions about power ON/OFF	5-12



CAUTION

Refer to chapters 3 and 4 only when installing this instrument. Only qualified workers should carry out mounting and wiring of this instrument.

6.	OPERATION AND ACTIONS	6-1
6.1	Before running the recorder	6-1
6.2	Power ON and state.....	6-2
6.3	Stopping and starting the recording operation	6-3
6.4	Switching data display screens	6-5
6.5	Display of alarm	6-6
7.	SETTING AND CHECKING PARAMETERS	7-1
7.1	Setting and checking	7-1
7.2	Outline of parameter setting procedure.....	7-6
7.3	Basic operation of setting screens.....	7-10
8.	SETTING PARAMETERS	8-1
8.1	Basic setting	8-1
8.2	Channel settings	8-8
8.3	Copying parameters	8-24
8.4	Setting calculation function	8-26
8.5	Setting timer for calculation.....	8-32
8.6	Setting for data display screen	8-34
8.7	Setting for F value calculation (Setting common to all channels).....	8-38
8.8	Setting totalizing (Setting common to all channels)	8-40
8.9	Setting for messages.....	8-44
8.10	Unit definition	8-46
8.11	Setting for DI (external control unit) function	8-47
8.12	Setting constant	8-49
8.13	Ethernet function setting	8-50
8.14	Setting password for parameter setting	8-53
9.	OPERATING MEMORY CARD.....	9-1
9.1	Displaying record data of memory card.....	9-1
9.2	Removing memory card (compact flash)	9-4
9.3	Totalizing start/stop setting	9-6
9.4	Function of reading settings from memory card (compact flash)	9-8
9.5	Function of writing settings in memory card (compact flash)	9-9
9.6	Setting password for memory card operation	9-11
10.	MAINTENANCE AND INSPECTION	10-1
10.1	Recommended replacement cycle of parts.....	10-1
10.2	Calibration.....	10-1
10.3	Formatting the memory card.....	10-1

11. CALIBRATION	11-1
11.1 Calibration method of measured values.....	11-1
11.2 Initializing the measured value	11-3
12. TROUBLESHOOTING.....	12-1
13. SPECIFICATIONS.....	13-1
APPENDICES.....	A-1
Appendix 1 Recording format (ASCII).....	A-1
Appendix 2 Parameters that cannot be set during recording	A-3
Appendix 3 Parameters that cannot be set while totalizing is underway	A-4
Appendix 4 Opening the PHU record data in ASCII format on Excel	A-5
Appendix 5 Timing of recording.....	A-6

1. INTRODUCTION

We thank you for purchasing Fuji Paperless Recorder PHU.

The instruction manual describes installation, operation, and maintenance of Paperless Recorder.

Read this manual carefully before use.

1.1 Paperless recorder

- (1) This recorder displays measured data in real time on the liquid crystal display. It is a paperless type that is also capable of saving the measured data to a compact flash card.
- (2) It can set up to 36 channels for the input types such as thermocouple, resistance bulb, and DC voltage (or current).
- (3) It allows the measured data saved to the compact flash card to be displayed on the display unit. Use of the support software attached to the recorder allows the saved data to be displayed on a personal computer.

1.2 Product check

Upon receiving the recorder unit, check the appearance for damage, and if the correct quantity of the accessories are supplied.

Check on accessories

This recorder comes with the accessories shown in Fig. 1-1. Check that they are all present.

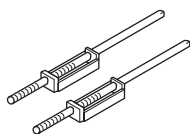

(1) Panel-mounting bracket



(2) PC support software (CD-ROM)

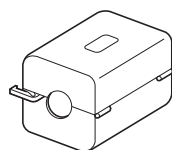

(3) Power supply noise filter

Fig. 1-1 Accessories

Product name		Quantity
(1)	Panel-mounting bracket	2
(2)	CD-ROM	1
	PC support software instruction manual	
(3)	Power supply noise filter	1
(4)	Quick reference	1

1.3 Check on type and specification

Code symbols are marked on specification nameplates. Check the type as ordered. (The specification nameplates are attached to the right of the case and at the rear of the display unit).

Digit	Specifications	Note	PHU	4	5	6	7	8	9	10	11	12	13
4	<Number of input points> 9 18 27 36			*	0	0	*	1	-	E	1	*	Y
7	<DI input> Without With (16 points)							0 1					
8	<Improvement No. (Fixed)>							1					
9	<Display language > English								E				
11	<Alarm output> Without Relay 10 points Relay 20 points Transistor (open collector) 16 points Relay 10 points + Transistor (open collector) 16 points Relay 20 points + Transistor (open collector) 16 points											0 1 2 3 4 5	
12	<Ethernet> Without With												Y E

1.4 Handling memory card (Compact Flash) – Cautions on handling

- (1) For the memory card, use SanDisk's compact flash memory (URL: <http://www.sandisk.com>).
Other memory cards may cause trouble to the recorder.

CAUTION

- 1) Be sure to format the memory card with the PC you use.
Format it as FAT16 or FAT. If it is formatted as NTFS, for example, it cannot be used because the PHU does not recognize it.
- 2) The memory card should be inserted in the proper direction and fixed securely to the slot.
- 3) Don't turn OFF the power or remove the card from the slot while data is being written in or read from the card, or recorded data may be damaged or lost.
- 4) Measured data saved to the memory card should be backed up once a month.
If the CF card should be broken, important record data will be lost. Be sure to backup the data.
Before using a CF card adaptor, check the capacity of the adaptor. If the capacity of the memory card to be formatted is larger than that of the adaptor, do not format the card. Otherwise the PHU does not recognize it even if it could be formatted on Windows.

- (2) Compact flash in the capacity range from 64MB to 512MB can be used.

Refer to the following tables for the storage capacity in the case of 9-channel recording (on condition that no events such as alarms or messages are occurring, and that integration is stopped).

(The number of days required for 18-channel recording is approximately one half of those shown in the table.)

(The number of days required for average value recording and instantaneous value recording is approximately twice of those shown in the table.)

Compact flash size		64MB				
Display refresh cycle		1 sec	10 sec	30 sec	1 min	10 min
Recordable capacity (about)	ASCII format	112 hours	46 days	140 days	280 days	7.7 years
	Binary format	448 hours	184 days	560 days	1,120 days	30.8 years

Compact flash size		128MB			
Display refresh cycle		1 sec	10 sec	30 sec	1 min
Recordable capacity (about)	ASCII format	226 hours	94 days	282 days	565 days
	Binary format	932 hours	388 days	3.2 years	6.4 years

Compact flash size		256MB			
Display refresh cycle		1 sec	10 sec	30 sec	1 min
Recordable capacity (about)	ASCII format	18 days	187 days	1.5 years	3 years
	Binary format	72 days	748 days	6 years	12 years

Note: Refer to Item 8.1 "Basic setting" for the selection of ASCII or binary format for data recording.

- (3) Data write to the memory card is performed according to the following timing. If the power is OFF in the writing cycle, note that the data will not be recorded.

Display refresh cycle	1 sec to 1min	2 min	3 min	5 min	10 min	20 min	30 min
Write cycle	1 min	2 min	3 min	5 min	10 min	20 min	30 min

Display refresh cycle	1 hour	2 hours	3 hours	4 hours	6 hours	12 hours
Write cycle	1 hour	2 hours	3 hours	4 hours	6 hours	12 hours

- (4) The data recorded in the compact flash can be regenerated on the PC by using the data viewer (contained in the attached CD-ROM).

If the data is recorded in ASCII format, it can be directly opened in a spreadsheet such as EXCEL. However, large-amount data cannot be opened (about 10MB or larger in the case of 9-point input, and about 5MB or larger in the case of 18-point input).

In those cases, read in data with the data viewer (contained in the attached CD-ROM), and perform CSV conversion to divide the file, which allows the data to be read in.

The data recorded in binary format cannot be directly opened in a spreadsheet such as EXCEL. Refer to Item 8.1 "Basic setting" for details.

Note: Be careful not to make the size of a file too large even if a large-capacity CF card is used. (Keep it to less than 10MB if possible.)

(5) Removing memory card

By prohibiting the writing on the memory card, the card can be taken out even if the recording or integration is not stopped. Refer to Item 9.2 “Removing memory card (compact flash)” for the procedure.

CAUTION

Make sure to prohibit writing before removing the memory card, when using FTP server function.

1.5 Ethernet communication function

By connecting the paperless recorder to Ethernet, the following function can be used (when E is selected for the 12th digit of the code symbols).

- FTP server function: Record files stored in the compact flash of the recorder can be downloaded from the PC on the network using Web browser (Microsoft Internet Explorer) or DOS prompt.
- Web server function: Measurements of the recorder or event log on the network can be displayed using Web browser (Microsoft Internet Explorer).
- E-mail function: E-mails can be sent to specified addresses on occurrence of an alarm or main unit failure.
- MODBUS TCP/IP function: Settings of the recorder can be read or written via the Ethernet.



2. NAMES AND FUNCTIONS OF PARTS

2.1 Names and functions of parts

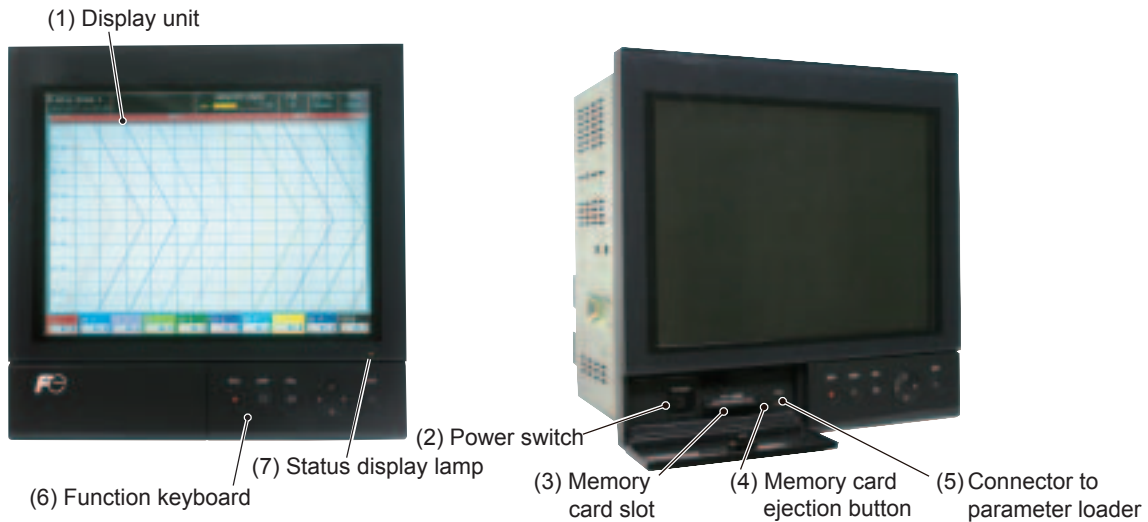

(1) Display unit

Allows the Real time trend screen, Bar Graph Display screen, Analog Meter Display screen, Digital Display screen, Totalized Value Display screen, Historical trend screen and other various Parameter Set screens to be displayed.

(2) Power switch

Used to turn the power ON or OFF.

(3) Memory card slot

Used for inserting the memory card

(4) Memory card ejection button

To remove the memory card from the slot, press this button.

CAUTION

1) Do not remove the memory card while recording is in progress (while the REC lamp on the display unit is highlighted) or during totalizing. Otherwise, the data cannot be recorded correctly, besides the past data may be damaged. Be sure to stop recording and totalizing before removing the memory card. (If the memory card is removed and inserted again while recording or totalizing is in progress, it is recorded as a new file.)

2) While the compact flash of the paperless recorder is accessed by FTP communication, do not take out the compact flash.

Furthermore, when the FTP server function is used, inhibit access to the compact flash in the “Memory card abstract” screen shown in “9.2 Removing memory card (compact flash)”, before taking out the compact flash.

(5) Connector to parameter loader

When changing parameters by using a loader, connect the exclusive cable (optional cable: PHZP1801) to the connector.

(6) Function keyboard

Used for operation, or setting and verifying each parameter.

(7) Status display lamp

Displays power ON/OFF, LCD (screen) ON/OFF, and the recording status.

Lamp ON : Power : ON, LCD : ON (recording/recording stop)





Lamp blinking (ON/OFF for 2 sec) : Power : ON, LCD : OFF (recording)

Lamp blinking (ON/OFF for 1 sec) : Power : ON, LCD : OFF (recording stop)

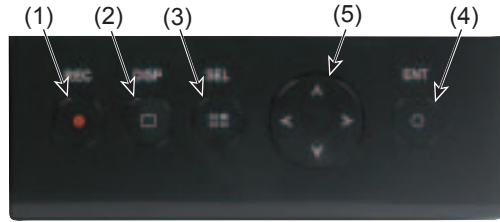
Lamp OFF : Power : OFF

Key operation



	Key name	Function
(1)	 (Record)	Used to start or stop recording. Pressing once starts recording, and pressing once again stops recording.
(2)	 (Display)	Used to switch displayed contents. Every time it is pressed, the display is switched in the following order: (1) → (2) → (3) → (4) → (5) → (6) → (7) and back to (1). (1) Real time trend display Displays the measurement data of an arbitrary channel (2) Key guidance display Displays the guide for key operation. (3) Bar graph/analog meter display Displays the measured data of the channel in a bar graph (or analog meter) (4) Digital display Displays the measured data of the channel in numerical values. (5) Totalizing data display Displays the totalizing data of an arbitrary channel in numerical values. (6) Event summary display Displays the alarm summary or message summary. (7) Ethernet log display Displays the FTP communication and E-mail sending log. Used to switch the parameter setting screen to the data display screen.
(3)	 (Select)	Used to switch from the data display screen to the parameter setting screen. Pressing the key on the parameter setting screen switches to the screen one step up. Note, however, that pressing the key on the menu screen does not change screens.
(4)	 (Entry)	(1) Used for selection on the setting screen or registration of the set data. (2) If the key is pressed while the scales are displayed on the real time trend display screen, historical trend display screen (*1), or recorded data display screen, the channels for which scales are to be displayed can be switched. (Scale of ch1 → scale of ch2 → → scale of ch9 → scale of ch1 → scale of ch2.....) *1: The screen in the past of the data currently recorded
(5)	 (Cursor)	(1) Used to select setting items. (2) Used to increase or decrease numerical values. (3) Pressing the ▼ key on the real time trend displays the historical trend screen (*1). At this time, the window can be scrolled using the cursor key. (4) Pressing the ◀ or the ▶ key on the real time trend display, bar graph/analog meter display, digital display, or totalized value display screen switches group screens as follows. ▶ key: Group 1 → 2 → 3 → 4 → 5 → 6 → 7 → 8 → 1 ... ◀ key: Group ... ← 1 ← 8 ← 7 ← 6 ← 5 ← 4 ← 3 ← 2 ← 1 *1: The screen in the past of the data currently recorded

2.2 Inserting and removing the memory card

The memory card is used for saving measured data. Before attempting to use the recorder, set it in the recorder slot securely.

This section explains how to insert the memory card into or remove it from the slot.

(1) To insert memory card

Step 1) Open the panel unit.



Step 2) Insert the memory card into the slot at the right side of the panel unit as shown in the photo.

CAUTION

Insert the card straight into the slot as shown in the photo at right.

Be careful not to forcibly press the card if it is inserted obliquely. Otherwise the pin on the PHU may be damaged.



(2) To remove memory card

Step 1) Press the memory card ejection button to remove the memory card from the slot.

CAUTION

(1) Do not remove the memory card while data is written in it (while the lamp indicating writing status is kept on). Refer to Item 9.2 “Removing memory card (compact flash)” for the removal of the memory card while recording is in progress.

(2) After inserting the memory card into the slot, don't remove the card before the recorder acknowledge it.

(3) Be careful with static electricity when removing the memory card.

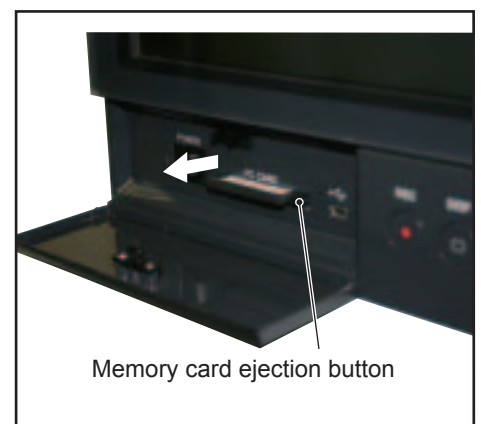

2.3 Recording data to memory card

(1) Recorded data:

Data can be recorded in the following three formats. Either ASCII or binary format can be selected for recording. Refer to Item 8.1 “Basic Setting.”

Trend data : Records the maximum and the minimum values, average value or instantaneous values of the measured value sampled at display update cycles.
Trend data file name to be created: S00****.FDT (**** is substituted by four-digit numerical value.)

Refer to “Appendix 1 (1) Trend data file” for recording format.

Event data : Records the information on occurrence or release of alarms and message issuing information.

Event data file name to be created: A00****.FDT (**** is substituted by four-digit numerical value.)

Refer to “Appendix 1 (2) Event data file” for recording format.

Totalizing data: Records the totalizing data every totalize recording cycle.

Totalizing data file name to be created as shown below.

Periodic	: T000000.FDT
Dairy	: D000000.FDT
Weekly	: W000000.FDT
Monthly	: M000000.FDT
Annual	: Y000000.FDT
Dairy (Time set)	: R000000.FDT
External	: E000000.FDT

(2) Parameter save data:

Setting file: Stores the setting created on the recorder main unit or the parameter loader.

Name of setting file: PA00000.PHU

(3) Recording capacity:

It depends on the capacity of the memory card.

Refer to the following tables for the storage capacity in the case of 9-channel recording (on condition that no events such as alarms or messages are occurring, and that totalizing is stopped).

- Maximum number of days to be recorded varies depending on a number of channel. The value of each channel in comparison with those in the table are as follows:
 - 18-channel: approximately half; 27-channel: approximately one-third;
 - 36 channel: approximately one-fourth.
- The number of days required for average value recording and instantaneous value recording is approximately twice of those shown in the table.

Compact flash size		64MB				
Display refresh cycle		1 sec	10 sec	30 sec	1 min	10 min
Recordable capacity (about)	ASCII format	112 hours	46 days	140 days	280 days	7.7 years
	Binary format	448 hours	184 days	560 days	1,120 days	30.8 years

Compact flash size		128MB			
Display refresh cycle		1 sec	10 sec	30 sec	1 min
Recordable capacity (about)	ASCII format	226 hours	94 days	282 days	565 days
	Binary format	932 hours	388 days	3.2 years	6.4 years

Compact flash size		256MB			
Display refresh cycle		1 sec	10 sec	30 sec	1 min
Recordable capacity (about)	ASCII format	18 days	187 days	1.5 years	3 years
	Binary format	72 days	748 days	6 years	12 years

Note: Refer to Item 8.1 "Basic setting" for the selection of ASCII or binary format for data recording.

(4) Recording cycle:

Refer to the following tables for the timing of writing the trend data to the compact flash.

The event data is written in the compact flash by the minute.

Display refresh cycle	1 sec to 1min	2 min	3 min	5 min	10 min	20 min	30 min
Writing cycle	1 min	2 min	3 min	5 min	10 min	20 min	30 min

Display refresh cycle	1 hour	2 hours	3 hours	4 hours	6 hours	12 hours
Writing cycle	1 hour	2 hours	3 hours	4 hours	6 hours	12 hours

(5) Timing to start recording:

The event data cannot be written in the compact flash until the first display refreshment cycle passes by.

3. MOUNTING METHOD

This unit is designed to be panel mounted.

3.1 Mounting location

Select the following location for mounting the unit.

- (1) A place that is not subject to vibration or shock.
- (2) A place where there is no dust, dirt or corrosive gas.
- (3) A place where ambient temperature falls within 0 to 50°C range with minimum temperature fluctuation (Recorder provided with Ethernet function: 0 to 40°C).
- (4) A place that is not struck directly by strong radiant heat.
- (5) A place that is free from water drip or dew condensation in the range of 20 to 80%RH.
- (6) A place that is well ventilated for the dispersion of heat generated from other devices.
- (7) A space that is accessible for wiring, and maintenance and check.
- (8) A place that is not affected by electromagnetic wave from wireless machine or portable telephones.
- (9) Mount the unit horizontally, with no tilt to the left or right (The forward tilt should be 0° but the unit may be inclined 0 to 30° rearwards.

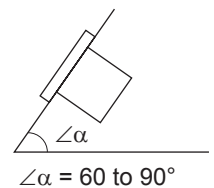

3.2 External dimensions and panel cutout dimensions

External dimensions

(unit: mm)

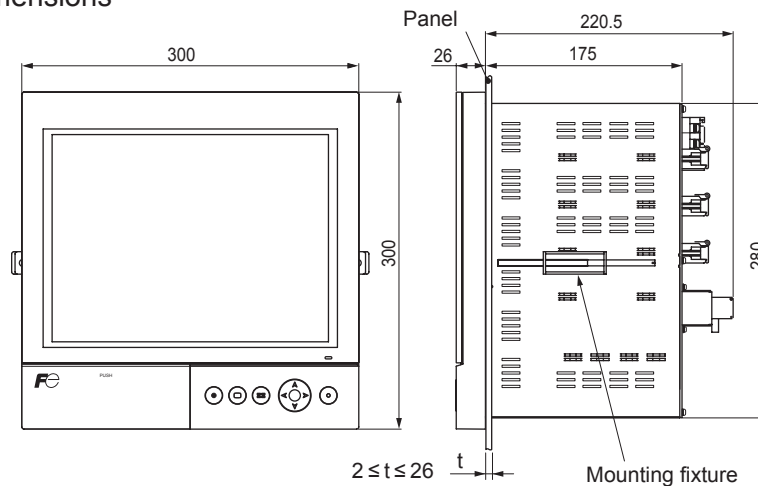

Panel cutout dimensions

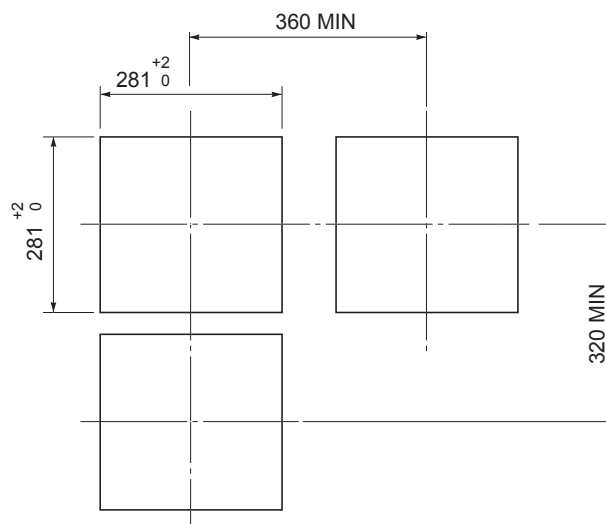

3.3 How to mount the unit onto the panel

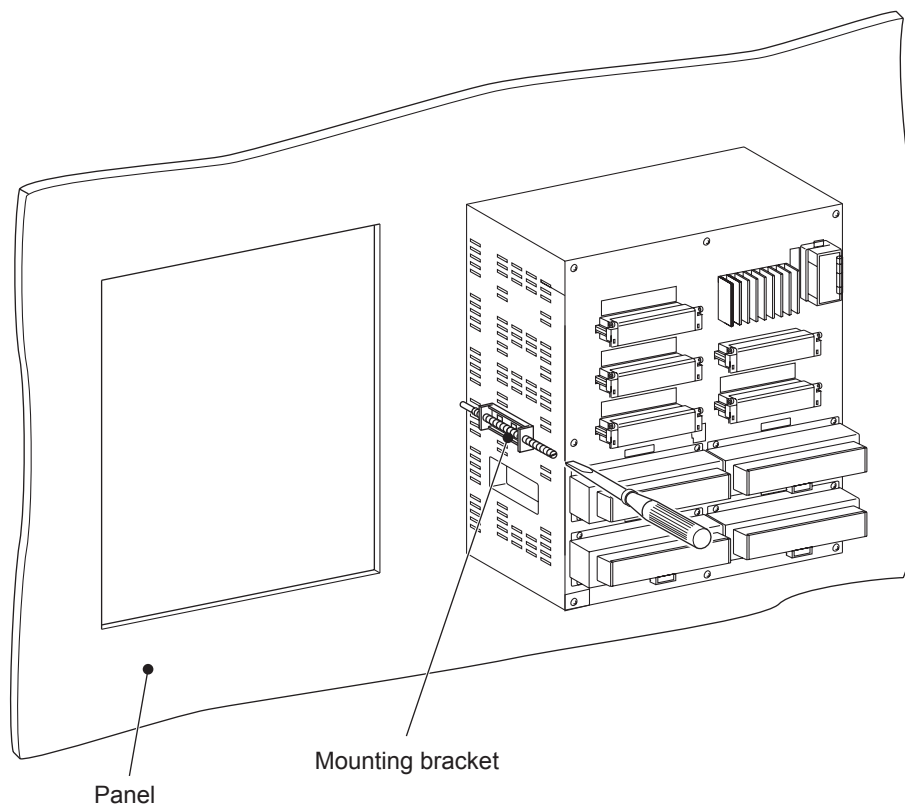

- Using the supplied mounting bracket, tighten the upper and lower screws until the panel is fixed.
- The panel to be used should be 2 mm or more in thickness.

CAUTION

Excessive torque may result in damage to front panel frame or case deformation.

Torque: 0.2 N·m

4. WIRING

4.1 Before wiring

(Note) When cables are connected to terminals of the recorder unit, do not apply pulling force to them excessively. Excessive force to the terminal may result in damage to the terminal or cable.

- (1) Use the power cable that has the performance equivalent to or higher than 600-V vinyl insulated power cable (IEC227-3). Install the attached noise filter within approximately 20cm from the power terminal of this instrument. (Wind the power cable 1 to 2 turns.)
- (2) For the thermocouple input, be sure to use a compensated lead wire.
- (3) Input signal cables should be wired separately as far as possible (30 cm or more) from power lines and high-voltage lines to minimize the effect of inductive noise. Shielded cables should preferably be used. In this case, the shield braids should be earthed at one point.
- (4) Up to 2 solderless terminals should be used when connecting cables to terminals. (Be sure to use an insulation cap.)

(Note)

- 1) At the completion of wiring of the input terminals, be sure to close the rear cover to ensure the compensation of reference contact when thermocouple input is used.

In case of thermocouple input, follow the steps to stabilize temperature at the terminal.

- Be sure to attach input terminal cover.
- Don't use a thick cable to prevent the effect of radiation. It is recommended that the cable with a diameter of 0.5 mm or less should be used.
- Don't mount other instruments near a fan to keep temperature stable.

- 2) For connection of lead wires to terminals, use of sleeve-insulated clamping terminals (for M3 screw) is recommended.

- 3) This unit has no power fuse. Mount a power fuse outside the unit as required.

Recommended fuse rating: 250V AC, 2A

- 4) Do not loosen screws that are secured to the terminal case and power terminal.

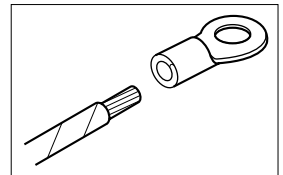

4.2 Connection to terminals

(1) Input terminal

⇒ Connect signal cable for each channel.

(2) Alarm output relay terminal -1

⇒ Connect Alarm relay output (DO1 to 10).

(3) Alarm output relay terminal -2

⇒ Connect Alarm relay output (DO11 to 20).

(4) Alarm output transistor terminal

⇒ Connect Alarm transistor output (DO21 to 36).

(5) DI input terminal

⇒ Connect DI signal input (DI1 to 16).

(6) Power terminal

⇒ Connect power cables to L N terminal.

Power source to be connected should be free from noise.

(7) Ground terminal

⇒ Connect to ⊕ terminal (Class-D, 100Ω or less).

(8) Ethernet terminal

⇒ Plug in the LAN cable for Ethernet communication.

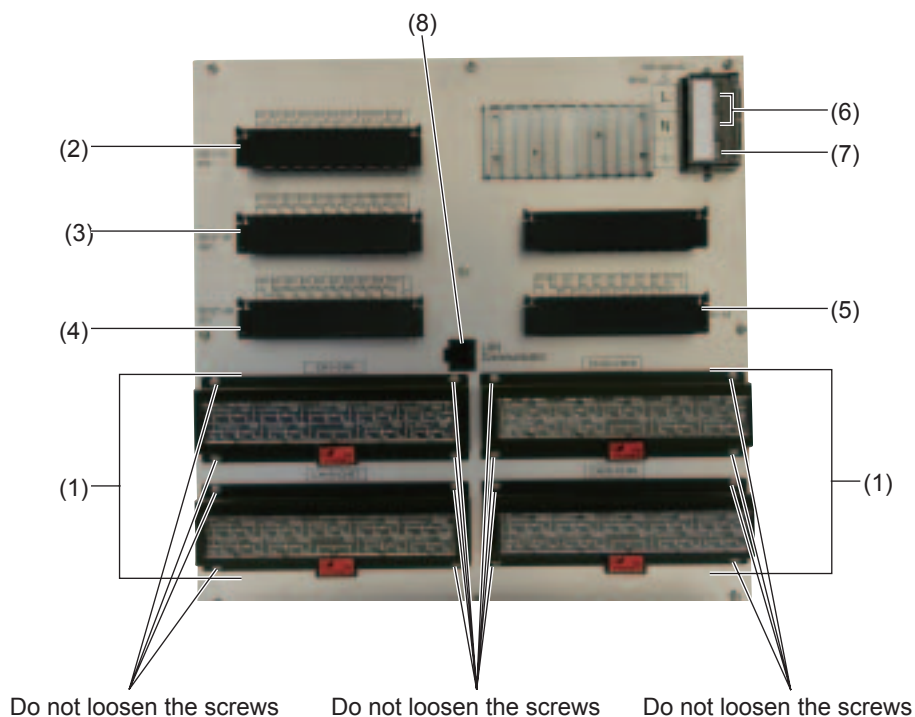

Note: Do not loosen the screws. Otherwise accurate measurement may not be carried out with thermo-couple input.

(1) Wiring of input terminal

- 1) Input terminal No. is determined for each channel.
- 2) When changing the type of input signal (see Item 8.2) after purchasing the unit, connect input terminals according to the relation between terminal No. and channel No..

CAUTION

Do not apply excessive voltage. Otherwise the PHU circuit may be damaged, and proper operation may not be performed.

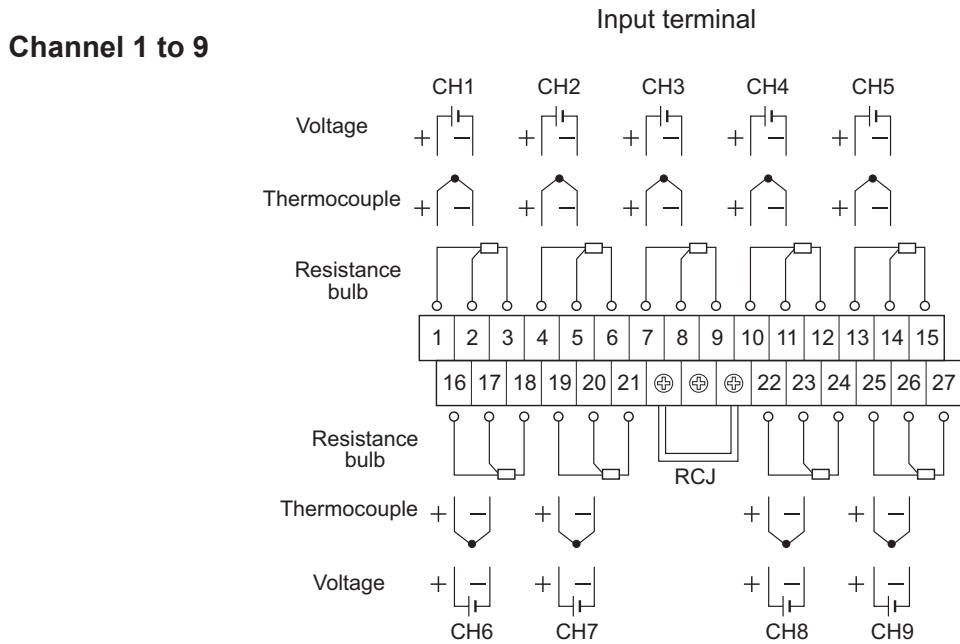

Note) For current input, connect optional shunt resistors to the voltage input terminals.

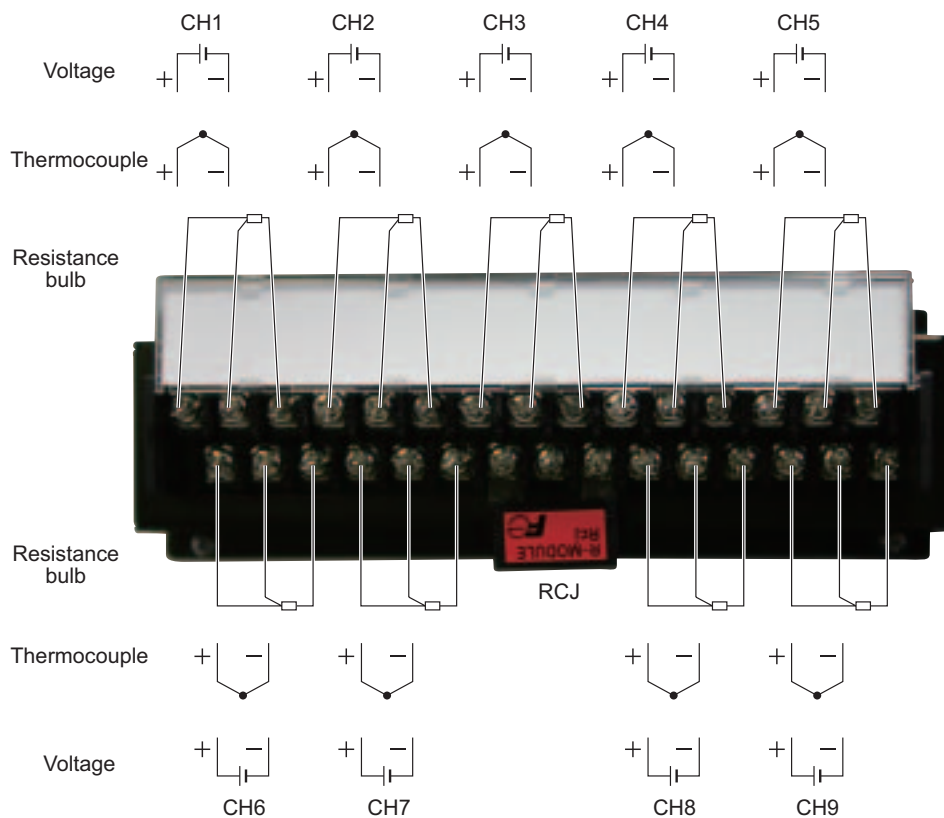

Channel 10 to 18

Input terminal

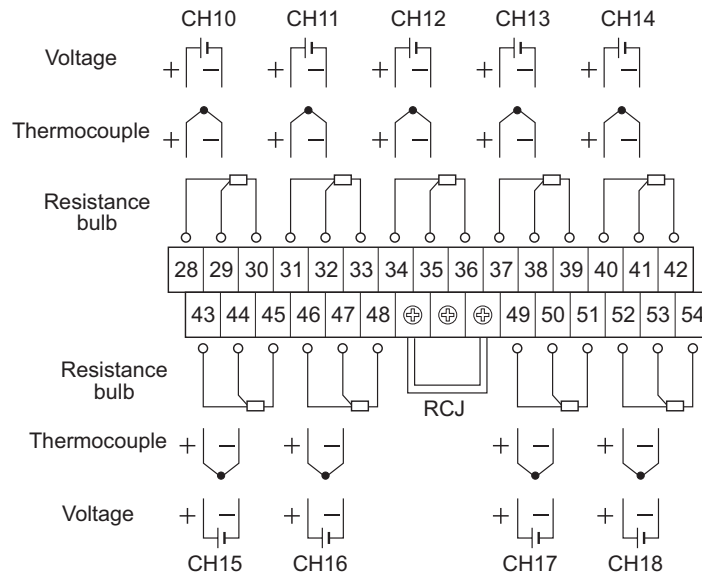

Note) For current input, connect optional shunt resistors to the voltage input terminals.

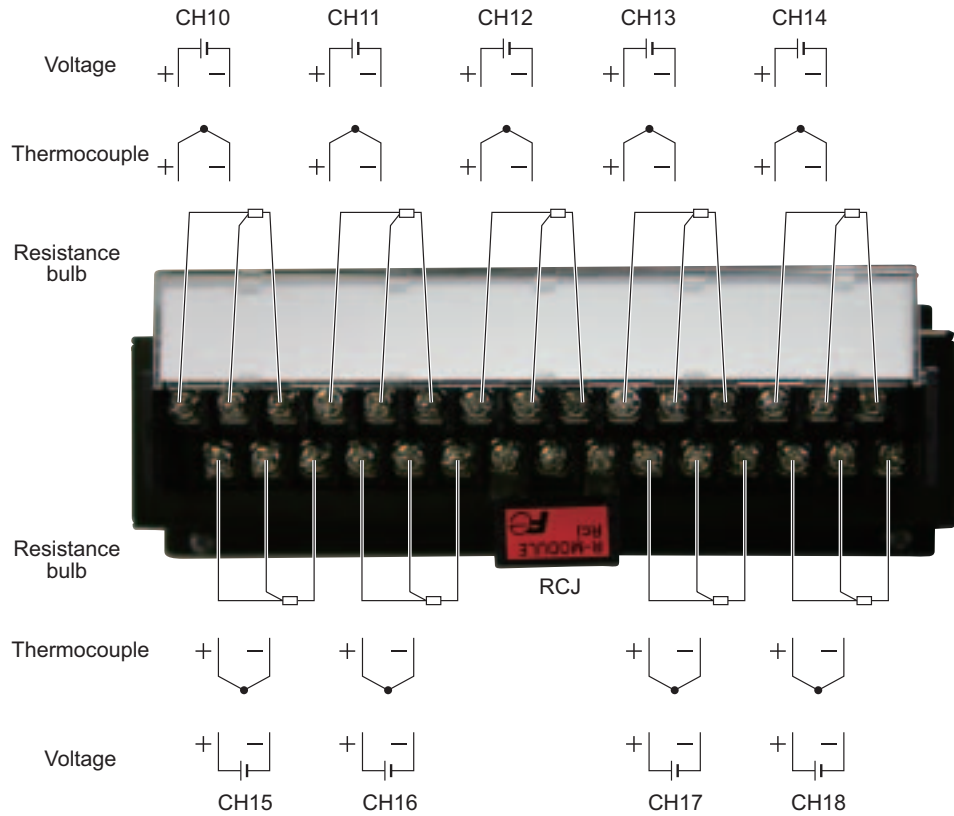

Channel 19 to 27

Input terminal

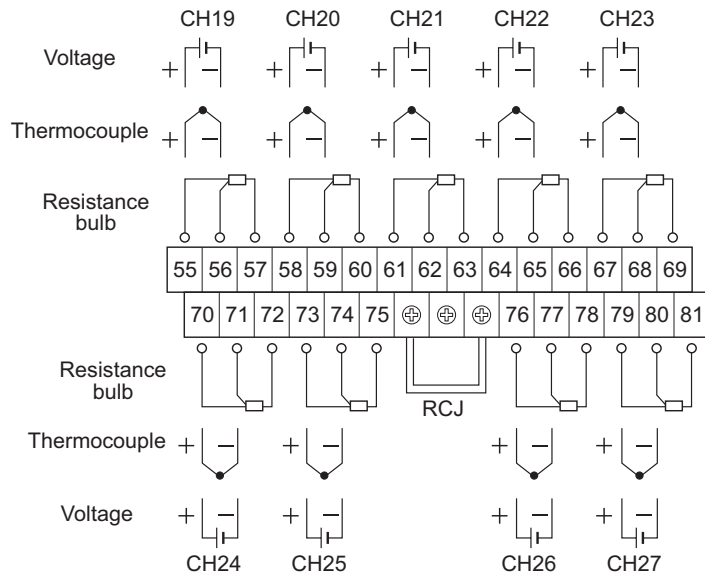

Note) For current input, connect optional shunt resistors to the voltage input terminals.

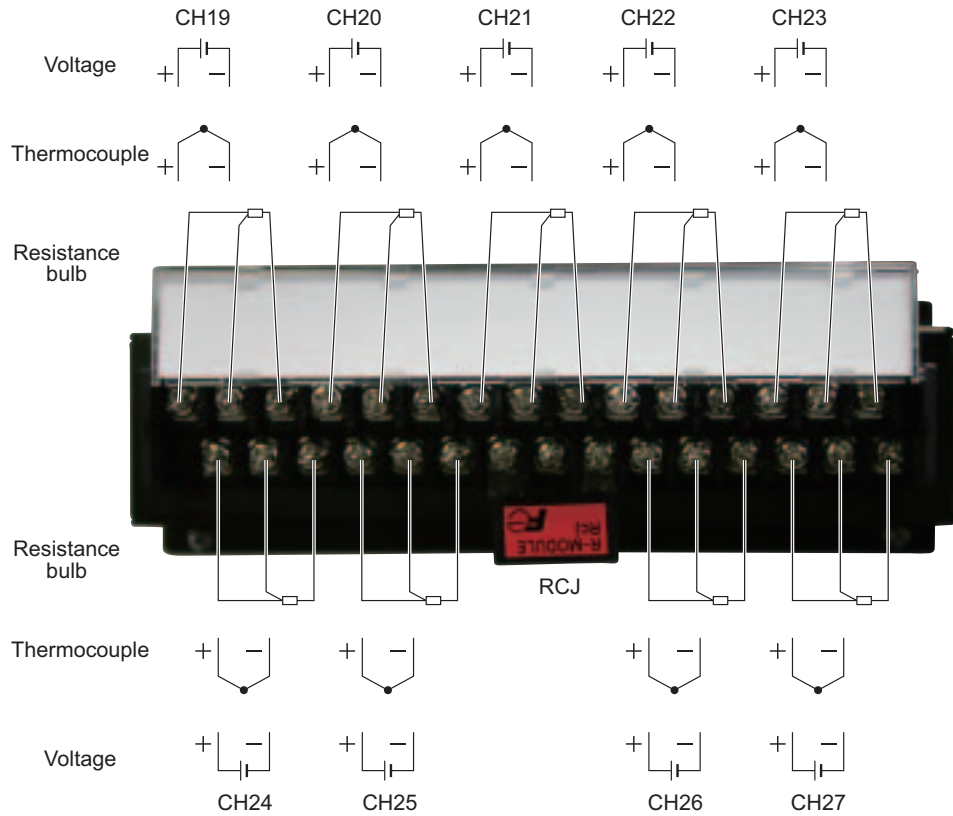

Channel 28 to 36

Input terminal

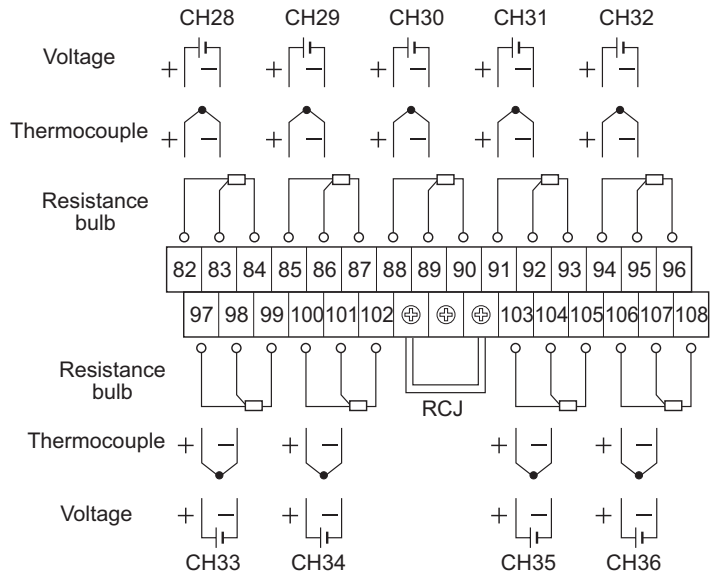

Note) For current input, connect optional shunt resistors to the voltage input terminals.

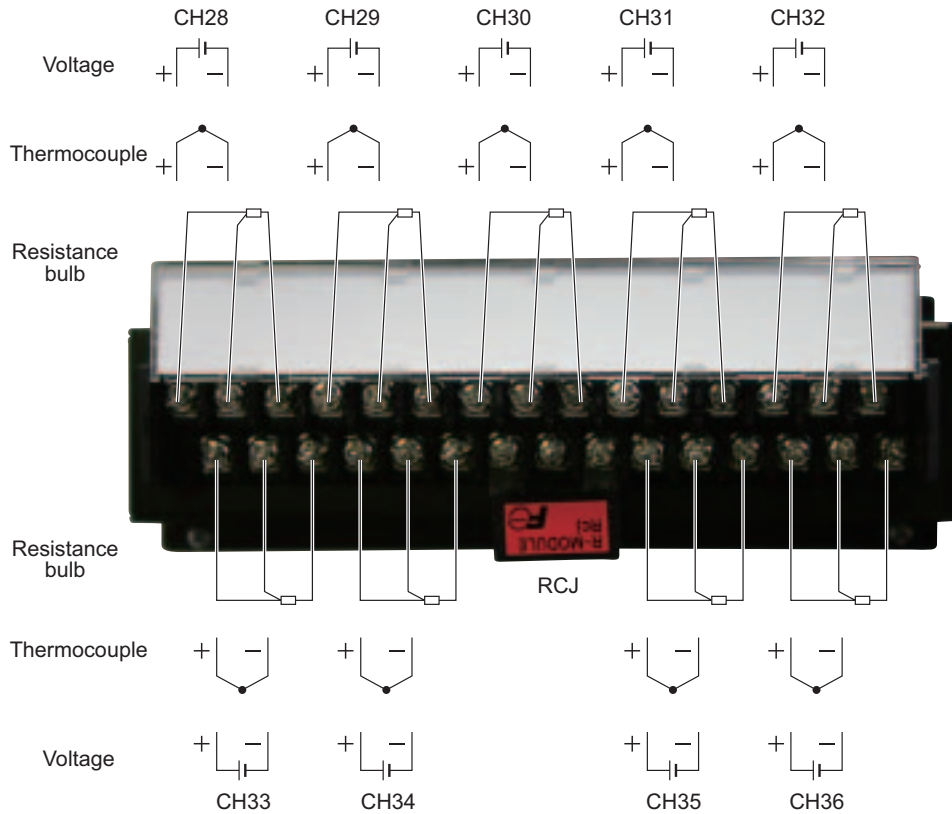

Wiring of input terminals (For an example, ch1 terminal number is noted in the parentheses)

(1) DC voltage input

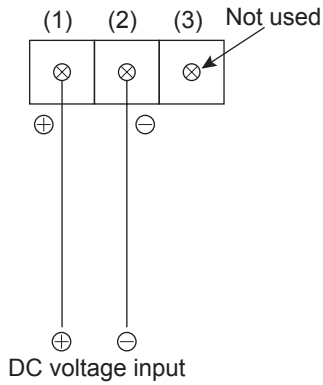

(2) DC current input

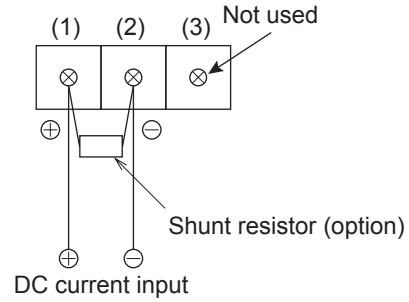

Example 1) For 4 to 20mA and 10 to 50mA input, $10\Omega \pm 0.1\%$ shunt resistance is used.
[In this case, set the input range]
to 500mV (see Item 8.2).

Voltage conversion by shunt resistance of 10Ω
4 to 20mA DC : 40 to 200mV DC
10 to 50mA DC : 100 to 500mV DC

(3) Thermocouple input

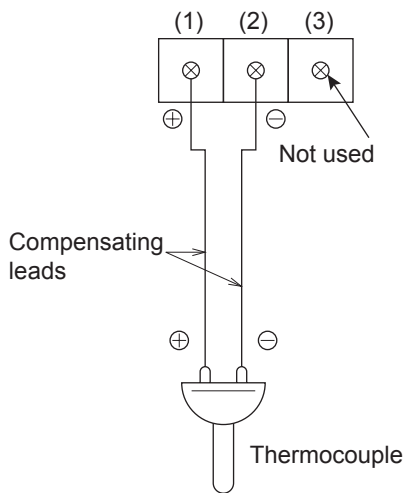

Note) Avoid using thermocouple input with wiring parallel to other instruments.

(4) Resistance input

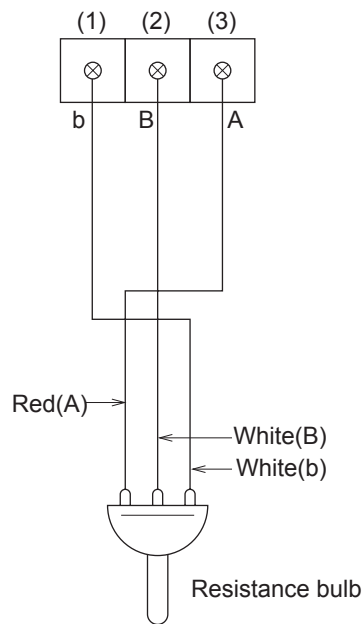

Note)

- 1) Input signals should be the same for every 2 channels.

Example) ch1: thermocouple
ch2: thermocouple } Any type of thermocouple can be set.
ch3: 5V }
ch4: 5V } 1 to 5V or 0 to 5V can be set.

For the setting method, see Item 7.4.

- 2) Do not remove RCJ module.

(2) Wiring of alarm output (DO)/DI (external control unit) (Option)

About external control unit (DI)

- This instrument is provided with the function of performing “start/stop of recording operation,” “F-value computation resetting,” “Start/stop of totalizing,” and “Message display” in response to the contact signals (DI) received from outside the instrument.

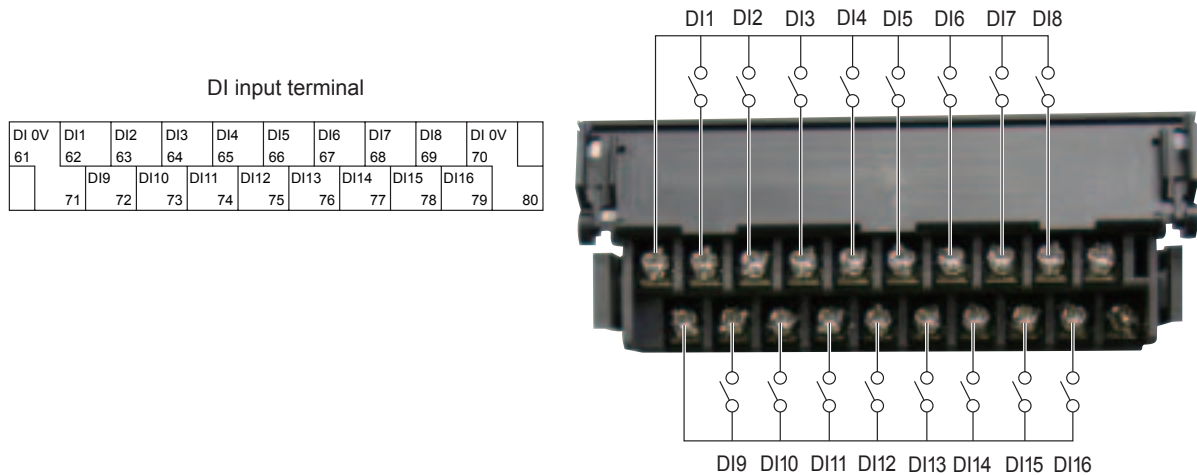

Note 1) DI (external control) unit is not insulated and should be used with a relay connected to the outside.

External contact capacity: 20V/0.05A DC, 1a contact or larger

Note 2) DI (external control) unit is operated as follows when the front switch is pressed.

(1) Recording start/stop

	External control		Front key
	Recording start/stop by DI		
	ON	OFF	
Recording suspended	Starts recording	No change	Starts recording
Recording in progress	No change	Stops recording	Stops recording

(2) F value calculation reset

	External control	
	ON	OFF
F value calculation in progress	Resets F value.	Continues calculation.

(3) Totalizing reset

	External control	
	ON	OFF
Totalizing in progress	Resets totalized value.	Continues totalizing.

(4) Totalizing start/stop

	External control	
	ON	OFF
Totalizing suspended	Starts totalizing	—
Totalizing in progress	—	Stops totalizing

(5) LCD

	External control	
	ON	OFF
LCD OFF	LCD ON	—

About alarm output (relay)

- 1) Alarm setting is provided at 4 points for each input channel. Up to 20 points for alarm output relay can be set as an option.
- 2) When an alarm occurs, the relevant terminals are shorted (ON).

1a contact output: Relay contact capacity : 240V AC/3A, 30V DC/3A (resistive load)

Alarm output (relay) -1

M3 screw

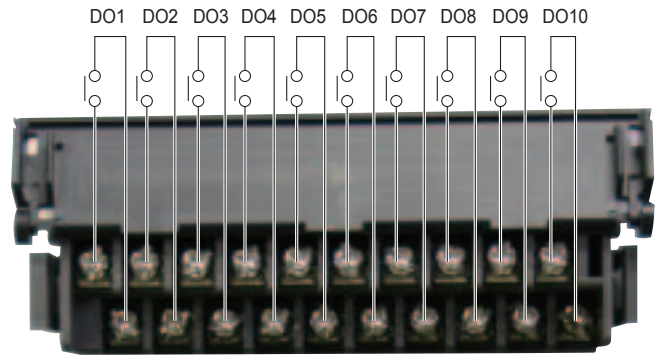
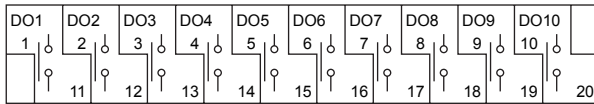

Alarm output (relay) -2

M3 screw

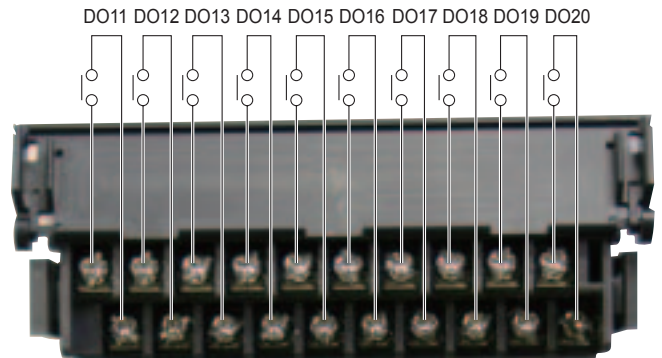
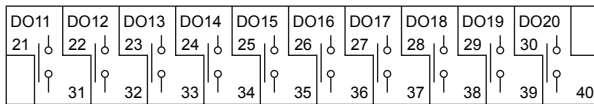

**Note: If lamps are provided on the outside, set a resistor to prevent rush current.
When relays or solenoids are used, set elements for contact protection (diodes or surge killers, etc).**

About alarm output (transistor)

- 1) Alarm setting is provided at 4 points for each input channel. Up to 16 points for alarm output (transistor) can be set as an option.
- 2) On occurrence of an alarm, the internal transistor is turned ON.

Output : Open collector

Rating : 30V DC/0.1A (resistive load)

Alarm output (transistor terminal)

M3 screw

VPD	DO21	DO22	DO23	DO24	DO25	DO26	DO27	DO28	PCD	
41	42	43	44	45	46	47	48	49	50	
	24V DC+	DO29	DO30	DO31	DO32	DO33	DO34	DO35	DO36	0V
	51	52	53	54	55	56	57	58	59	60

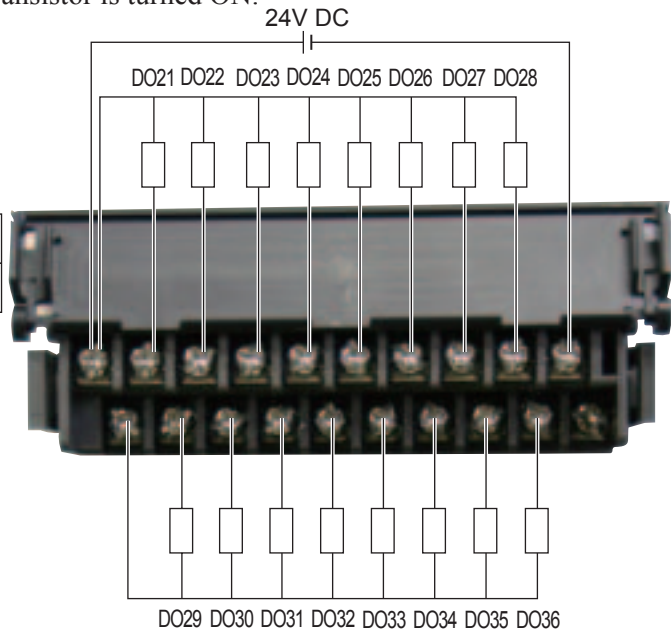

Note: This is not relay out.

Do not apply voltage or feed current larger than the rating. Otherwise the internal circuit may be damaged, and the instrument stops operating.

(3) Ethernet (option)

Note: Select E for the 12th digit of code symbols to use this option.

Ethernet communication specifications are as follows.

Note: Install the LAN cable far away from the power supply line or strong electric line as possible to avoid the influence of induction noise.

Item	Specifications 10BASE-T
Communication speed	10 Mbps
Communication mode	Base band
Maximum network length or Maximum node spacing	Up to 500 m (4-stage cascade)
Maximum segment length	Up to 100 m (between node and HUB)
Connection cable	UTP (Unshielded twisted pair cable) 22-26AWG
Communication protocol	TCP/IP

(4) Cautions on connection of input signals via barrier

- 1) When thermocouple or resistance bulb is used for input:
Measurement value error is generated because resistance value within the barrier is added.
Calibrate the measurement value in a state where the input, barrier, and the recorder are connected.
See section 9.1 for details of calibration.
- 2) Use our Zener barrier (PWZ) with 100V AC series power supply (85 to 150V AC) according the restrictions placed to maintain safety ratings.

4.3 Connecting recorder to loader

- (1) When connecting the recorder to a loader, use optional PC loader communication cable (PHZP1801) as shown below.



The loader cable should be connected to the USB port of PC.

CAUTION

Be sure to display the data display screen (refer to Item 6.4) instead of the parameter setting screen before using the loader. Otherwise, the set value may not be written.

5. DISPLAY FUNCTION

5.1 Basic composition of Data Display screen

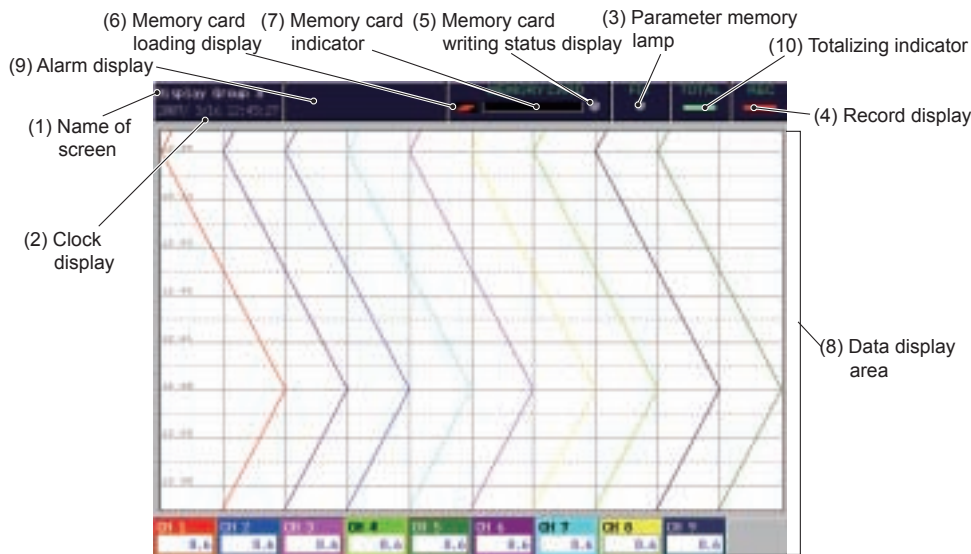

- (1) Name of screen
Displays the screen name (“Display Name”) that was set arbitrarily.
- (2) Clock display
Displays date and time.
- (3) Parameter memory lamp
If the lamp blinks in red, it means that parameters are not saved to the flash memory. Perform the “Recording set values” in the equipment.
- (4) Record display
The REC lamp is lit when the measured data is being recorded. On the “Real Time Trend” screen, data will be displayed only when the recorder is in recording.
- (5) Memory card writing status display
Turns ON when measured data is being written in a memory card.
- (6) Memory card loading display
It indicates the loading state of the memory card.
 - Gray display : Shows the state where the memory card is not loaded in the slot.
 - Green display: Shows the state where the memory card can be pulled out.
 - Red display : Shows the state where the memory card must not be pulled out.
- (7) Memory card indicator
It indicates how much of the memory card has been used in graphs. At 90%, it turns red. When the overwrite function of the recording file is set to OFF, the recorder stops recording at 100%. Replace the memory card before it is used up.
- (8) Data display area
It displays measured data in real time trend, bar graph, or digital display on the screen. (See item 5.2 to 5.4.) Measured data are displayed for channel 1 to 9 at factory shipment.
- (9) Alarm display
It displays alarm information that occurs at present (channel No. and alarm No.).
If more than 1 alarm occurs, it displays one alarm after another in every 3 seconds.
- (10) Totalizing indicator
While totalizing is in progress, the TOTAL lamp is lit. Refer to 5.5 for details of totalizing screen.

5.2 Real time trend display of measured data

Measured data can be displayed in waveforms. The vertical or horizontal directions can be selected by setting. By pressing ◀ or ▶ key, four screens with different display contents (scale display and screen structure contents [group configuration], Tag No. unit display, etc.) can be selected one after another.

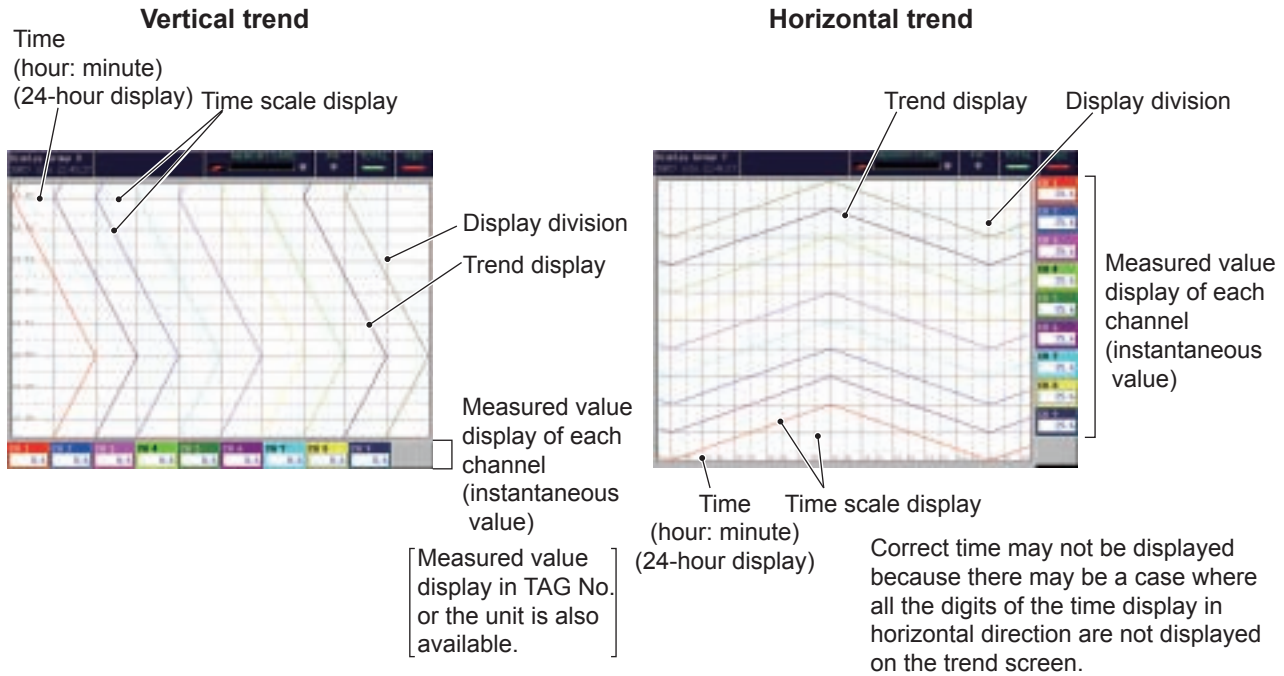

*) The screens consist of those selected in "Menu" → "Parameter setting" → "Display setting".

- 1) The display unit allows measured data to be displayed in waveforms only when recording. If the recorded values exceed the limits of 0 % and 100%, they will be displayed at 0% and 100% positions, respectively. If waveforms of more than 1 channel are displayed at the same position, the trend lines overlap each other. In this case, color of the channel with the largest number is given priority over those of other channels. (Example: In the case of ch2 and ch8, the color of ch8 is displayed.)
- 2) Display refreshment cycles are selectable from parameters of 1 sec to 12 hours. Relations between the parameter and chart speed are shown in tables below. After the start of the recording, the initial refreshment cycles will start at the time of 00: 00: 00 when the recording is continued.

(Example) When display refreshment cycles are set to 1 minute, it will start at the next cycle of m hour: n minute: 0 second.

Display refresh cycle (sec)	1	2	3	5	10	20	30
Chart speed (mm/h) as converted	1296	648	432	260	130	65	43

Display refresh cycle (min)	1	2	3	5	10	20	30
Chart speed (mm/h) as converted	22	11	7.2	4.3	2.2	1.1	0.7

Display refresh cycle (hour)	1	2	3	4	6	12
Chart speed (mm/h) as converted	0.36	0.18	0.12	0.09	0.06	0.03

-
- 3) The Historical Trend screen is displayed by pressing the cursor key (▼) when the Real Time Trend is displayed. This screen allows currently recorded waveform data to be read from the memory card, tracing back to the past. To return to the Real Time Trend screen, press the **(DISP)** key.
 - 4) The recorder performs the recording by pressing **(REC)**, and it displays waveforms without inserting the memory card into the slot. In this case, about 400 data can be displayed in historical trend. To display the data exceeding 400 items, insert the memory card into the slot before starting the recording.
 - 5) If the power is turned OFF while recording, data written in the memory card will be destroyed. Be sure to press the **(REC)** key to stop the recording, and then turn OFF the power.
 - 6) If the input signal is burnt out, or over/under range is displayed, the recording line is displayed at 0% or 100% position (at 100% position if the signal is burn-out). Note that, the line is displayed at the position equivalent to 0.26V for 0-5V input with the input kept open, and at the position equivalent to 260mV for 0-500mV input with the input kept open.

5.3 Display of measured data in bar graphs or analog meters

The measured data can be displayed either in bar graphs or analog meters. The display type can be selected by referring to Item 7.3 “Basic operation of setting screen,” and Item 8.6 “Setting for data display screen.”

1. The measured data is displayed in a bar graph.

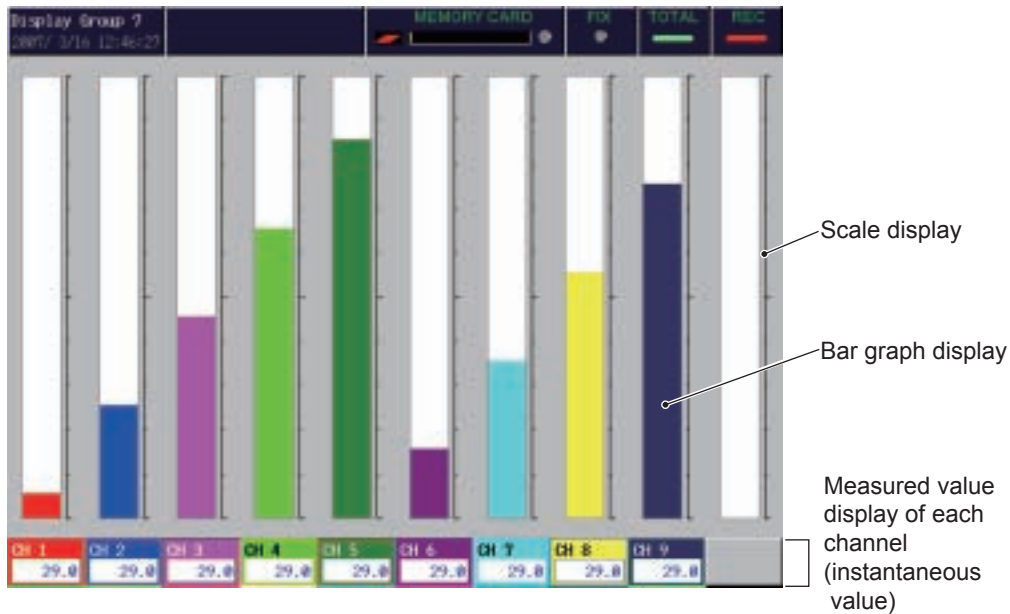

2. The measured data is displayed in analog meters.

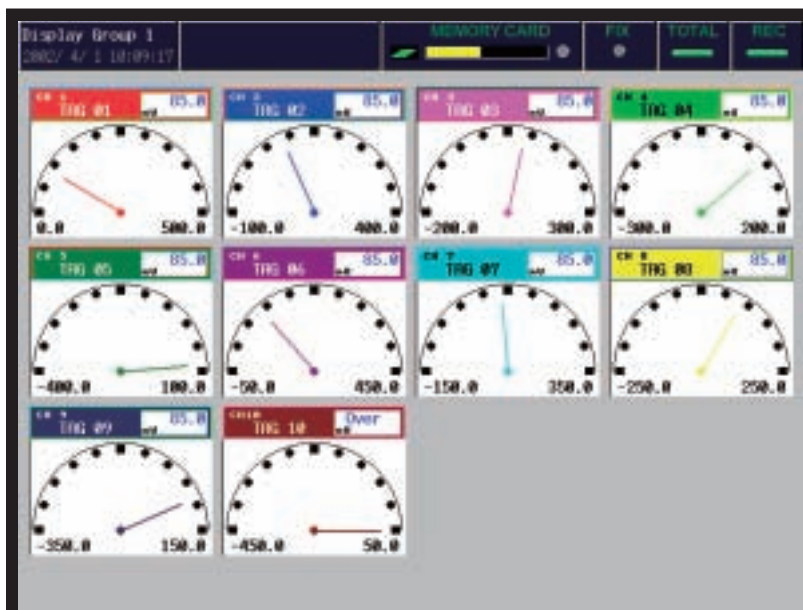

- (1) Setting of display ranging from 0 to 100% is displayed in graphs.
- (2) Display refreshment cycles are fixed to 1 sec.
- (3) The recorder displays measured data even when it stops recording.

5.4 Digital display of measured data

Measured data is displayed in numerical values.



- (1) Measured values of each channel are displayed in digital value.
- (2) Display refreshment cycles are fixed to 1 sec.
- (3) When an alarm occurs, Alarm No. at the channel is displayed in red.

5.5 Totalizing data display

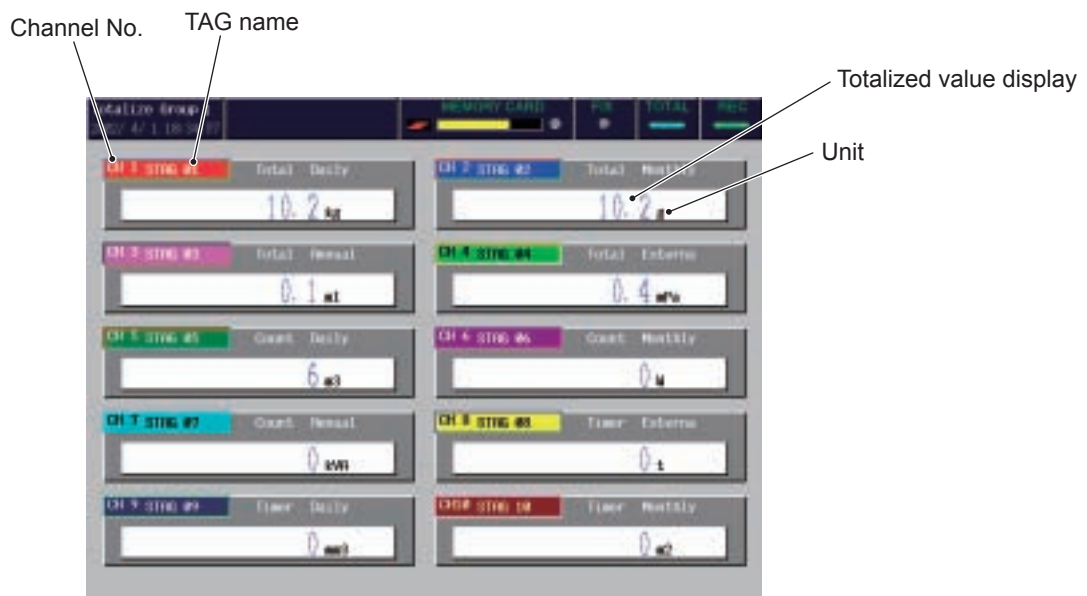

- (1) The value displayed depends on the setting of parameter “Reset operation.”
 If ON is selected, the totalized value by totalize base time is displayed.
 If OFF is selected, the total value from the start of totalizing is displayed.
- (2) Display update cycle is fixed to 1 second.

-
- (3) The value of totalized data to be recorded depends also on “Reset operation.”

If the setting is ON, totalized value is recorded at every totalize base time.

If the setting is OFF, sum total from the totalize start time is recorded.

Example: The data at the flow rate of 100L/hour is recorded as follows.

Elapsed time	Totalize reset	
	OFF	ON
1 hour	100	100
2 hours	200	100
3 hours	300	100

- (4) Totalize calculation is not reset even if the power is interrupted.

Upon restoration of the power, totalize calculation resumes starting from the data before the power interruption.

(If the file in the CF card used before the power interruption is lost at the time of power restoration, a new file is created. The data during the power interruption is not added.)

- (5) While totalize calculation is suspended, totalize data is not displayed. It is not displayed, either, while totalize calculation is suspended with “Daily (Time set)” or “External” selected as Totalize type.
- (6) The instrument can operate not only as a totalizer but also as a timer or a counter depending on the setting of “Totalize calculation.”
- a) If the setting is Totalizer, totalize function is performed.
 - b) If the setting is Counter, the number of times of DI ON or alarm ON during the totalize period is displayed and recorded.
 - c) If the setting is Timer, the duration of DI ON or alarm ON during the totalize period is displayed and recorded.

In all of the above cases, time is displayed based on the time set in a parameter, “Totalize base time,” with all digits to the right of the decimal point discarded.

- (7) On totalize 4-channel display screen, totalize start/stop time and the previous totalized value are displayed.
- (8) Totalizing is performed until the maximum value 999,999,999 is reached. Totalizing is not performed when exceeding that value.

5.6 Event summary display

Alarm information and message information history can be displayed.

The contents of messages can be displayed as message information.

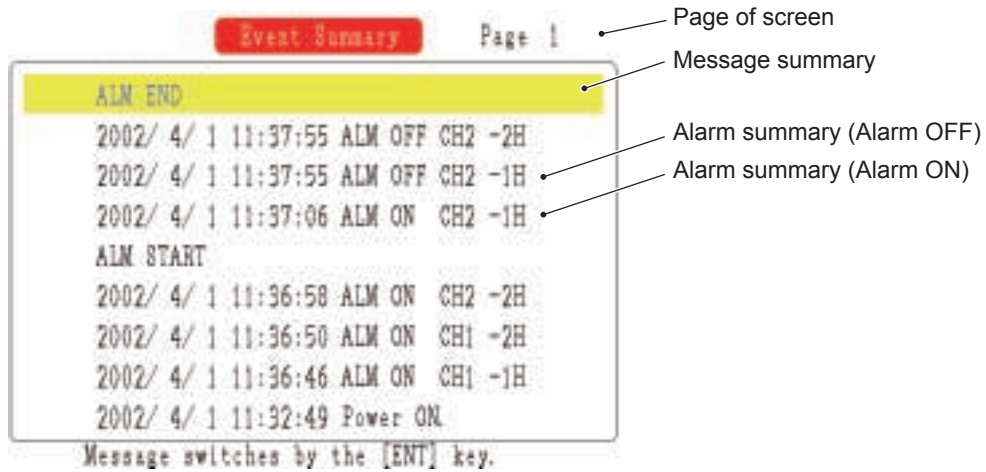

- (1) A maximum of 180 events can be displayed on the screen.
- (2) Page scrolling can be performed by pressing ◀ or ▶ key.
- (3) When events occur, they are displayed on the screen despite in the recording state. If the recorder is not in the recording state, events are not recorded in the memory card.
- (4) Once displayed, the event is kept displayed until the power is turned off (turning off the power clears the event buffer).
- (5) Press the **[ENT]** key to switch between message contents display and message start time display. The message contents are initially displayed.
- (6) How to view the event summary and message summary is as follows:

Example of alarm summary

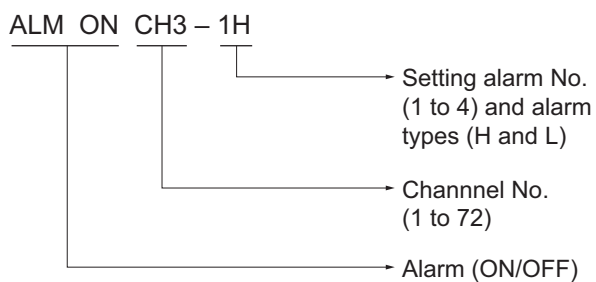

Example of message summary

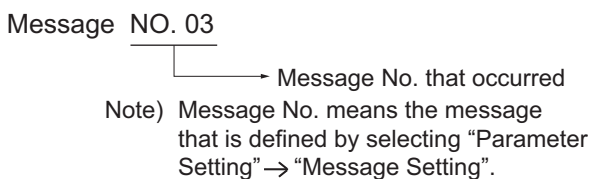

Example of message display

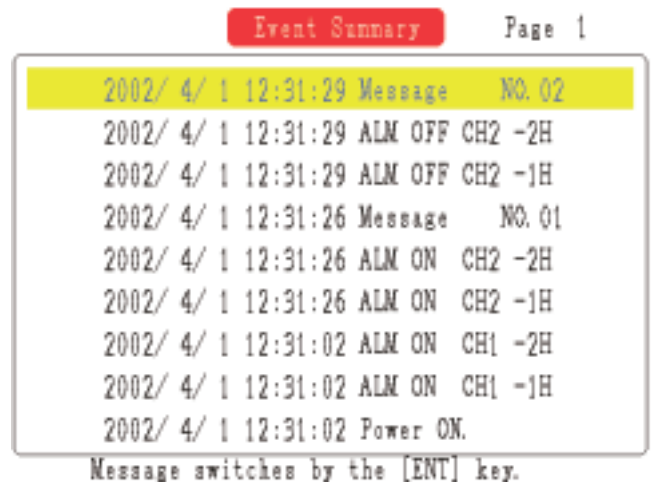

-
- (7) Turn OFF/ON the power, and event summary is displayed.
Message is changed according to recording status.
1) When power is turned OFF/ON while recording is suspended

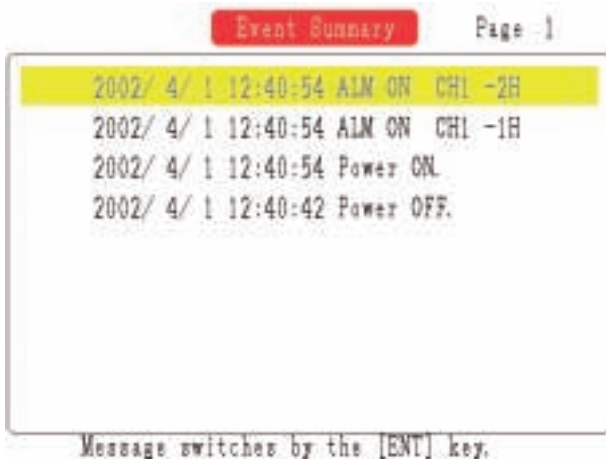

(Not recorded in the event file.)

- 2) When power is turned OFF/ON while recording is in progress

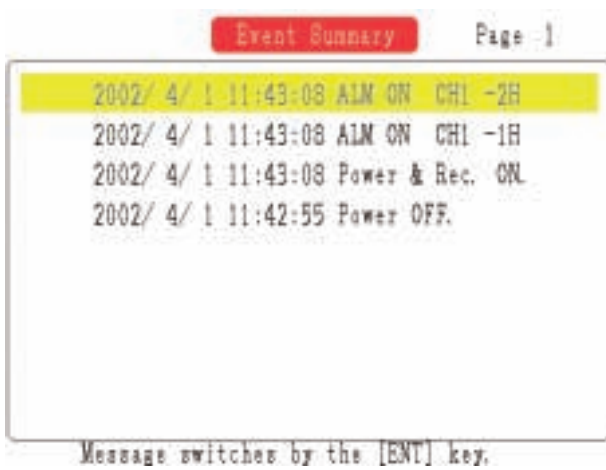

(Recorded in the event file.)

5.7 Ethernet log display

The communication items of Ethernet function (FTP, E-mail, and MODBUS TCP/IP) can be displayed.

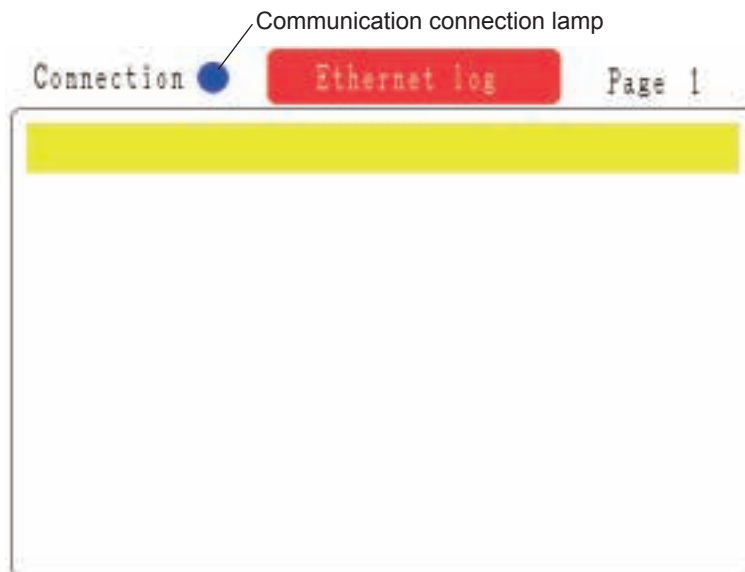

- (1) Up to 180 communication items can be displayed.
- (2) Pages can be turned using horizontal cursor key.
- (3) The log appears every time communication is carried out irrespective of the recording status.
- (4) Once displayed, the contents of communication are kept displayed until the power is set to OFF. (Communication buffer is cleared when the power is set to OFF.)
- (5) Details of the display are as follows.

Communication contents display

- E-mail transmission display (E-mail No. is E-mail trigger No.)
 - E-mail sent : "E-mail No.1"
 - E-mail send error : "E-mail No.1 NG"
- FTP communication display
 - FTP server log in : "FTP LOGON USER1"
 - FTP server log off : "FTP LOGOFF USER1"
- MODBUS TCP/IP communication display
 - Communication start : "MODBUS Start"
 - Communication stop : "MODBUS Stop"

5.8 Historical trend display

Pressing the ▼ key in the real time trend screen displays the screen shown below, which indicates the history of data currently recorded.

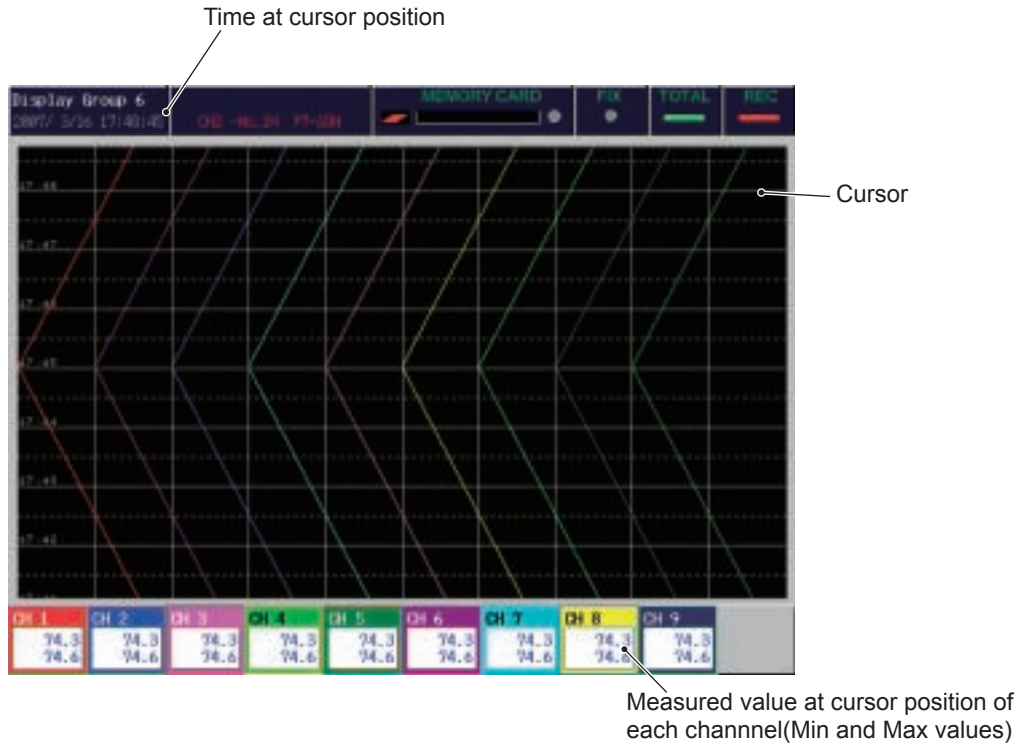

- (1) It allows the data recorded in the memory card to be displayed. The display can be scrolled by using the cursor expressed in a white dotted line. The cursor can move vertically (▲ or ▼) key or horizontally (◀ or ▶) key. Min. value or Max. value at the position of the cursor are displayed at the lower part of the screen.
- (2) Recording start/stop cannot be performed on the screen. To do this, switch the “Historical Trend” screen to “Real Time Trend” screen. However, this “Historical Trend” screen cannot be shifted to the “Parameter Set” screen. To shift the “Real Time Trend” screen, be sure to press the (SEL) key.
- (3) The data that can be displayed on the historical trend screen is the one currently recorded or the data held immediately before the recording is stopped. The data that was recorded in the past and whose recording was then stopped must be displayed on the record data display screen, or reproduced on the PC using the data viewer.

The following items are displayed on the historical trend screen based not on the setting of the past recording but on the currently selected values.

- Trend direction
- Number of screen partition
- Trend scale display
- Color bar display selection

-
- (4) Press the **DISP** key while the historical trend screen is displayed, and following “Display time setting” screen appears.

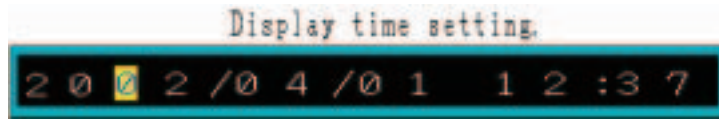

Enter the time of currently recorded data you want to display and press the **ENT** key. Then, PHL displays historical trend data at entered day and time. To display past data, entered day and time appears the bottom of the historical screen. To display farther data, entered day and time appears the top of this screen.

5.9 Display on the occurrence of main unit failure

- (1) Display at CF card memory FULL

If the memory of the CF card becomes full, recording is stopped with the following message displayed on the trend screen, etc. (totalizing is not suspended). Immediately replace the CF card.



- (2) Display at the end of battery life

If the battery voltage becomes low, the following message appears on the trend screen, etc. Immediately stop the recording and totalizing, and ask your distributor for repair.

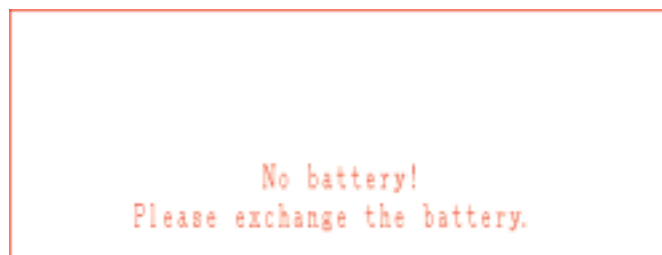

5.10 Cautions about power ON/OFF

(1) Recording state and record file

If the power is turned OFF when the recorder is in the recording, data written in the memory card may be damaged. Be sure to stop recording by pressing (REC) key, and then turn OFF the power. In addition, if the power is OFF with the recorder in the recording, the recorder will start recording when the power is turned ON again. In this case, data will be recorded as a new file.

(2) Recording set values

After parameters have been set, register the set values by selecting “Basic setting” → “Register data”, or they will return to the former values when power is turned OFF.

(3) Clock function

The clock is backed up by an internal lithium battery. The battery life is expected to be about 10 years at normal temperature. Although there is no need to set the clock when the power is turned ON, an error may occur every time the power is turned ON/OFF (about 1 sec per ON/OFF operation).

(4) If the power is turned off due to a power failure and turned on again while recording is in progress, a message “Power & Rec.ON.” appears at the top of the event file and event display.

(5) If the power is turned off, totalizing resumes when the power is turned on again, beginning from the value before the power off. Data is recorded in the totalize file used before the power off. (Note that if the file used before the power off is lost from the CF card, a new file is created and recording is restarted.)

6. OPERATION AND ACTIONS

6.1 Before running the recorder

Check the following points before starting operation.

Loading the memory card

- (1) Inserting and removing the memory card..... See Item 2.2.



Wiring

- (1) Input terminals..... See Item 4.2.
- (2) Alarm terminals (option)..... See Item 4.2.
- (3) Power and ground terminals..... See Item 4.2.



Conformity of input connection to recording channel

- (1) Channel settings..... See Item 8.2.

6.2 Power ON and state

- (1) Open the panel unit. Turn “ON” the power switch at the upper center of the panel unit.
- (2) After power ON, the self-check function starts up.



- (3) Insert a memory card, and then check with the memory card load indicator that the card can be used. (It can be used if the memory card load indicator is kept ON in green or red, and it cannot be used if it is kept flickering.) If the memory card load indicator is kept flickering in red even if the CF card is inserted, remove the CF card, check the direction of insertion (see Item 2.2) and insert it securely. If the indicator is still flickering, the CF card may not have been formatted, or some parts may be defective.

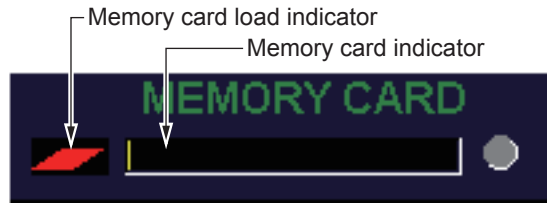

- (4) Measured data are displayed for each channel.



* TAG. No. or the unit display is also available according to screen configuration setting.

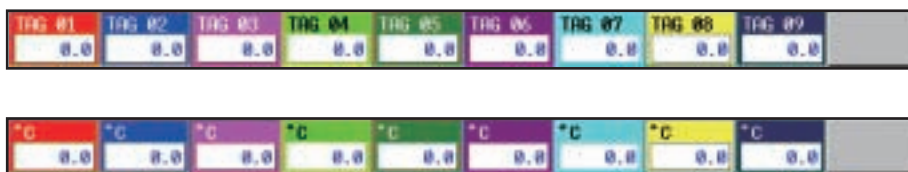

6.3 Stopping and starting the recording operation

(1) Recording start

- 1) To start the recording, press the **(REC)** key. The REC lamp is lighted and measured values are displayed in waveforms on the data display unit. Also, it starts saving the measured values to the memory card.

* Recording is performed at the timing described in “Appendix 5 Timing for recording.”

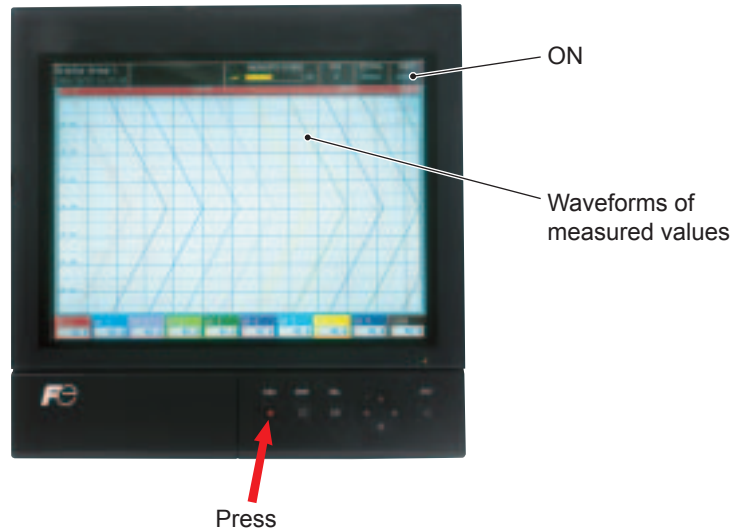

- 2) When the password for stopping and starting the record operation is set, the password setting screen is displayed as follows. Therefore, make a setting of the password. When the password is correct, the recording is started.

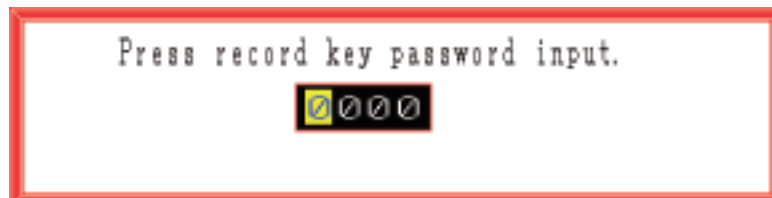

- 3) If the CF card is not inserted, the following message appears. Press the **(REC)** or the **(ENT)** key to start recording. Press the **(SEL)** key, if recording does not start.

Note: If recording is carried out with the CF card not inserted, data cannot be recorded.

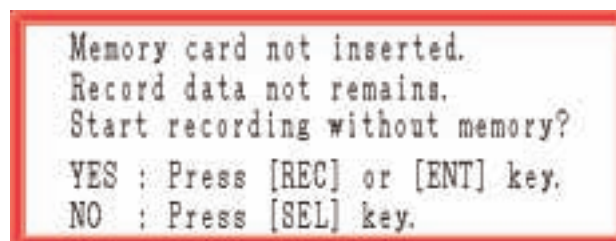

(2) Recording stop

- 1) To stop recording, press the **REC** key. The following message appears. To stop the recording, press the **REC** key again, and press the **SEL** key to continue recording.

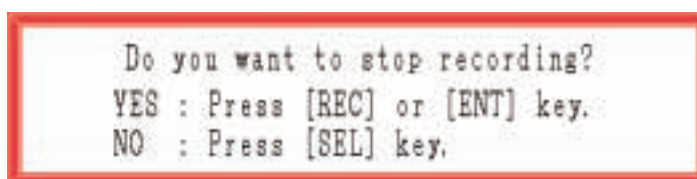

- 2) After the stop of the recording, the REC lamp comes off. The trend display on the data display unit stops. Carry out the recording of all data that have not yet written in the memory card.

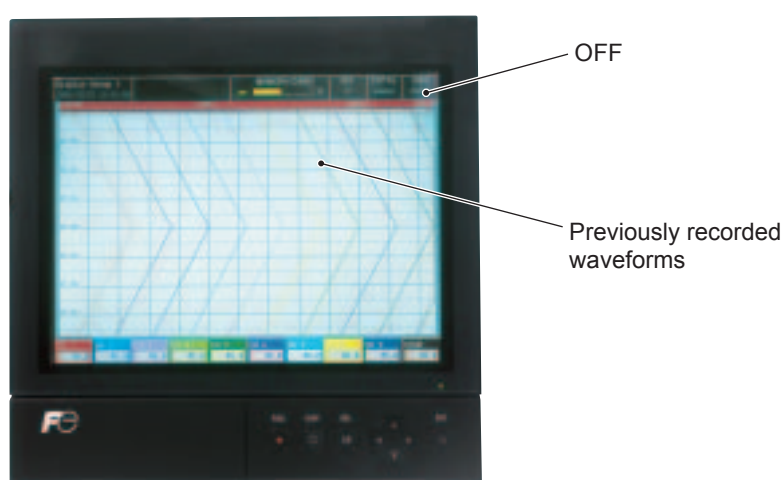

- 3) When the password for stopping and starting the record operation is set, the password setting screen is displayed as follows. Therefore, make a setting of the password. When the password is correct, the recording stop confirmation screen is displayed.



6.4 Switching data display screens

Data display screens include real time trend screen, bar graph (analog meter) screen, digital screen and totalizing screen. Every time the **DISP** key is pressed, the screen switches to another one. To display the historical trend screen, press the **▼** key in the real time trend screen.

Press the **◀** or **▶** key in the real time trend screen to switch to each group screen.

* If group screens are switched in high speed, the color on the color bar may not be displayed correctly. Display the screen once again in such cases to restore proper color display.

Refer to Item 8.6 for selection of bar graph/analog meter display.

The structure of the data display screen is as follows.

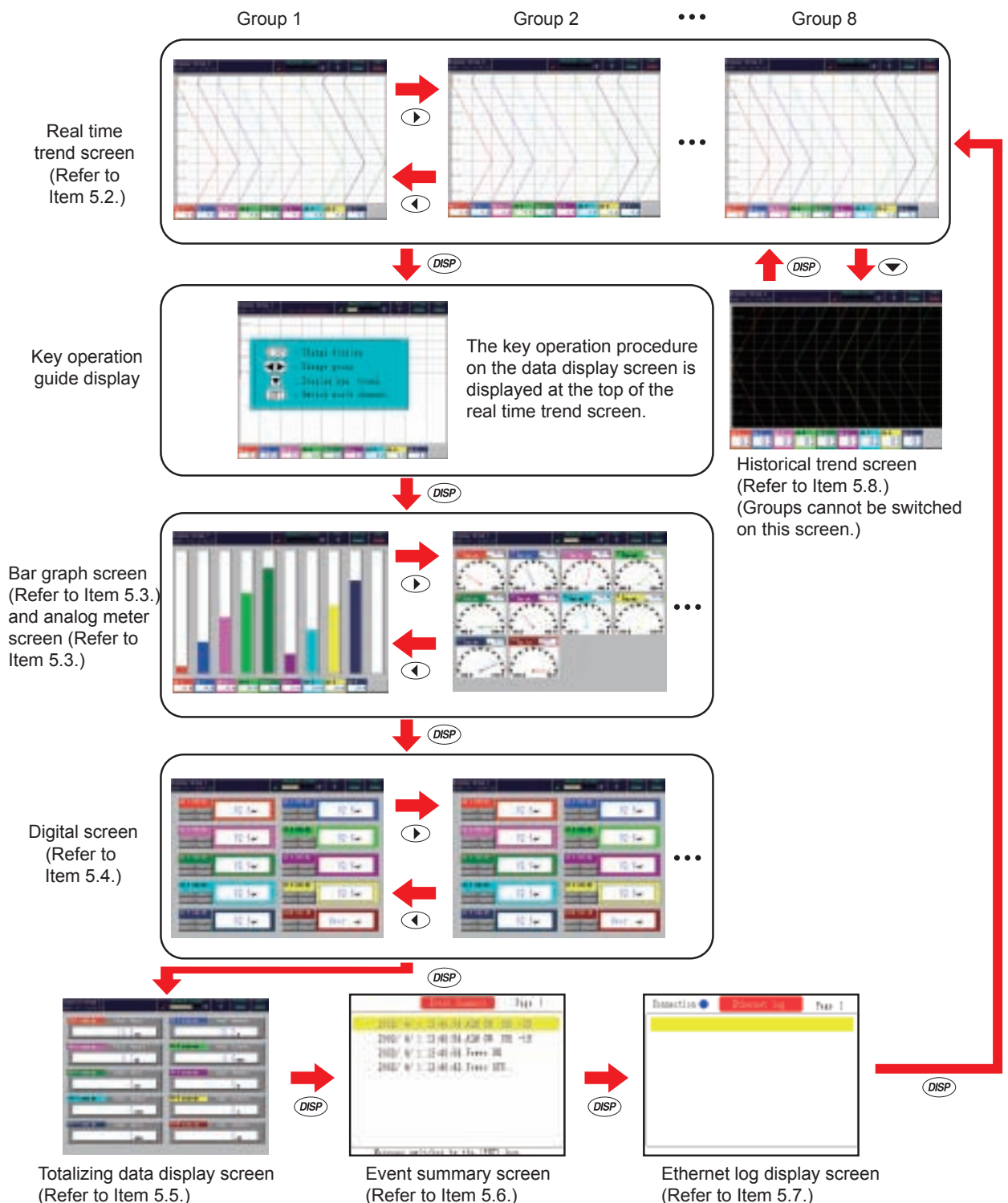

6.5 Display of alarm

(1) Alarms that occurred on the Trend Display, Bar Graph and Digital Display screens:

When an alarm occurs, its content is displayed.

(The display is kept on until the alarm is reset.)

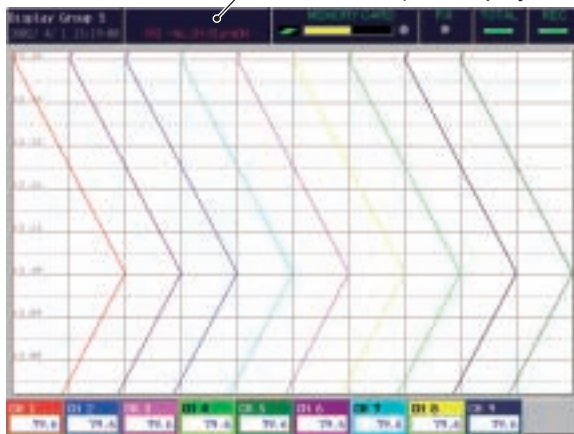

Example of alarm display

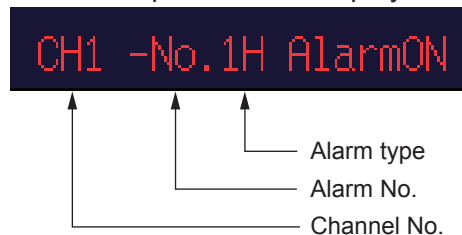

It is indicated that an alarm of alarm No.1 and alarm type H occurs at channel 1.

* If an alarm occurs on the “Digital Display” screen, Alarm No. at left of “Measured value display” comes on in red.



* If an alarm occurs against the current input, the alarm contents are displayed on the historical screen and the record data display screen of the memory card. This is not the past alarm record.

7. SETTING AND CHECKING PARAMETERS

7.1 Setting and checking

Follow the description of Item 7.2 “Outline of parameter setting procedure” to enter into each screen, and then follow the description of Item 7.3 “Basic operation of setting screens” to make parameter setting.

- (1) Parameters are factory-set as given in Item 7.1 table(1). Turning on power as they are initiates operation (indication and recording). Change the parameter setting as required.
- (2) Recording range consists of multi-ranges. Set the range as desired. The input types are the same for every 2 channels.
- (3) Alarms, TAG No. and messages are not set. Set them as needed. An input filter is set at 3 seconds.
- (4) Press the (SEL) key in the real time trend display screen to display the “Menu” screen. Refer to Item 7.2 for the contents and the operation of the “Menu” screen.

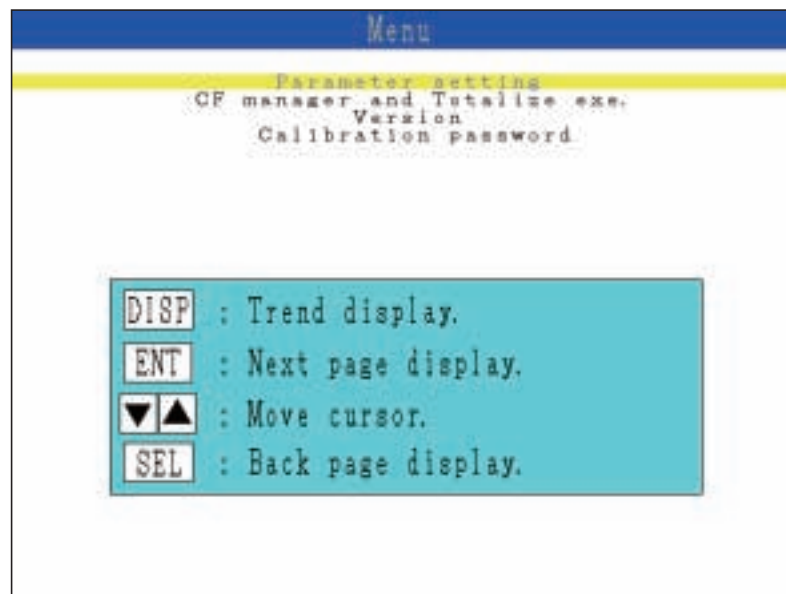

- (5) To go to “Parameter setting” screen, “CF manager and Totalize exe”. screen or “Calibration password” screen, you must enter 4-digit password when you have already entered each password.

Example: Parameter setting screen

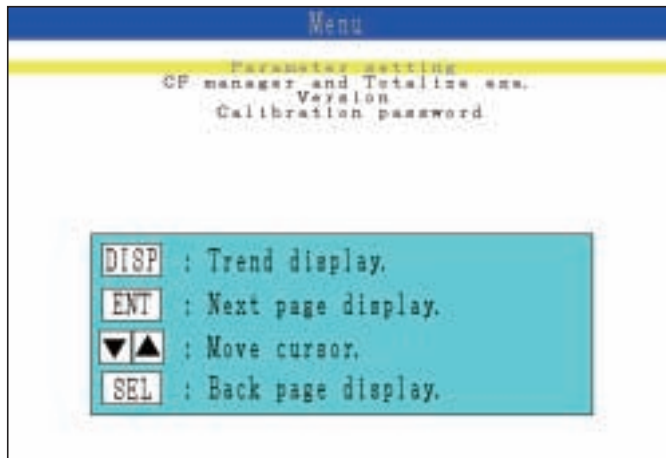

(in case of incorrect password)



◀, ▶ keys : To move the cursor
 ▲, ▼ keys : To change numerical value



(in case of correct password)

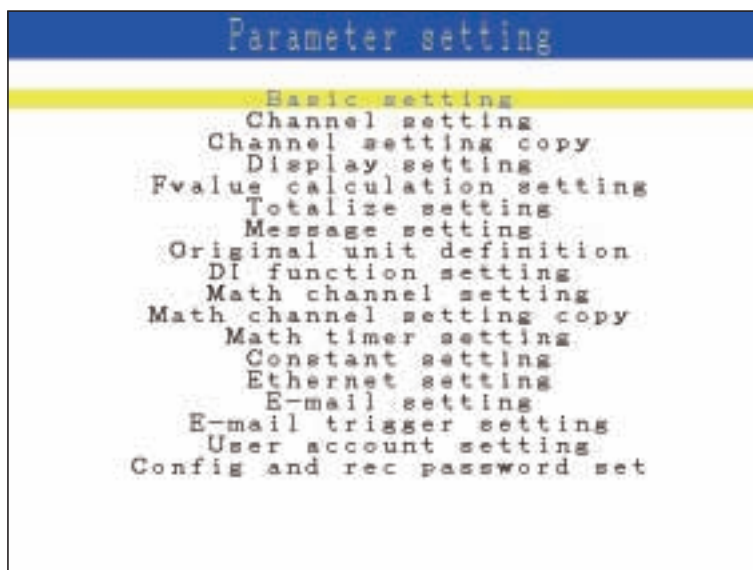

Note) After setting the parameters, select “Basic setting” / “Register data” in order to save the set information to a flash memory. To reset parameter set values, press (DISP) key. So, the following message appears. Press the (ENT) key twice.
The parameter has been reset.

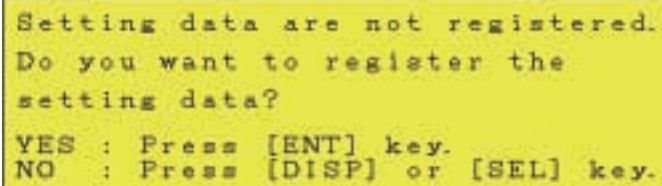
A screenshot of a device display with a yellow background and black text. The text reads: "Setting data are not registered. Do you want to register the setting data? YES : Press [ENT] key. NO : Press [DISP] or [SEL] key." The text is centered and uses a monospaced font.

```
Setting data are not registered.  
Do you want to register the  
setting data?  
YES : Press [ENT] key.  
NO : Press [DISP] or [SEL] key.
```

Table (1) Parameters as set by factory (initial values) (1/2)

Parameter name	Setting at delivery (Default value)	Setting range	Remarks	
Basic setting	Display refresh cycle : 1 second	1 second to 12 hours	*1 LCD keeps turning on when set "0".	
	Display compression : 1/1	1/1, 1/10, 1/30, 1/60		
	Alarm hysteresis : 0.2%	From 0.00 to 100.00%		
	Alarm latch : OFF	OFF, ON		
	LCD lights out time : 0 *1	0 to 60 minutes		
	DO output at memory FULL: None	None, DO1 to DO36		
	DO output at battery END: None	None, DO1 to DO36		
	File division cycle : No division	No division, 1 hour, 1 day, 1 week, 1 month		
	File overwrite : OFF	OFF, ON		
	Date format : yyyy/mm/dd	yyyy/mm/dd, dd/mm/yyyy, dd-mmm-yy, mm/dd/yyyy, mmm-dd-yy		
	Select language : English	English, French		
	MODBUS station No. : 1	0 to 255		
	MODBUS communication baud rate: 19200	9600, 19200 bps		
	MODBUS parity bit : Odd	None, Odd, Even		
	Front communication : ON	OFF, ON		
	Record data format : ASCII	ASCII, Binary		
	Time setting : —	—		
Register data :	—			
Channel setting	Input type : K-Type TC (K thermocouple)	Skip, K, E, J, T, R, S, B, N, W, L, U, PN thermocouple, Pt100, JPt100, Ni100, Cu50, Pt50, 50mV, 500mV, 1-5V and 0-5V range	Set the same input type for every 2 channels.	
	TAG1 : TAG ** (**: channel No.)	Up to 8 characters		
	TAG2 : Blank	Up to 8 characters		
	Unit : °C	°C, °F, Engineering unit in case of voltage input		
	Input range (range start/end): 0 to 1200	Engineering value		
	Decimal point position : *****.	*****, *****., *****.**, ***.**, **.****		
	Input filter : 3 seconds	0 to 900 seconds (In increments of 1 second)		
	Subtraction channel : None	0 to 72 (No subtraction at 0)		
	PV shift : 0.0	Engineering value -3276.7 to 3276.7		
	PV gain : 100%	0.00 to 327.67%		
	F value calculation function: OFF	OFF, ON		
	Display color: depends on channel No.	14 colors		
	Recording type: Maximum/minimum value recording	Instantaneous value recording, average value recording, maximum/minimum value recording		
	Recording mode : With record	With record/Display only		
	Totalize setting			
	Totalize tag: STAG ** (**: channel No.)	Up to 8 characters		
	Totalize calculation : OFF	OFF, ON		
	Totalize type : Periodic	Refer to Item 8.8		
	Digital input : DI1	Digital input, Channel alarm		
	Totalize base time : /h	/s, /min, /h, /day		
	Reset operation : ON	OFF, ON		
	Totalize unit : —	Can be arbitrarily selected		
	Totalize cut value : 0.0°C	Engineering value		
	Totalize scaling value : 1	1 to 32767		
	Alarm setting			
	Alarm No. 1 type : OFF	OFF, H, L		
	Set point : 0.0°C	Engineering value		
	DO relay No. : None	None, DO1 to DO36		
	From alarm No. 2 to No. 4 There are the same items above.			
	Math channel setting	Formula setting: All formula are blank		Calculation: +, -, *, / Function: ABS, POW, SQR, LOG, LN, EXP, RH, MAX, MIN, H-P, L-P, AVG, SUM Input: Input channel, Totalizer input, Digital input, Communication input, Constant, Temporay data
		Tag1: TAG ** (**: channel No.)	Up to 8 characters	
		TAG2 : Blank	Up to 8 characters	
Unit : °C		Engineering unit		
Measuring range (range start/end): 0.0 to 500.0		Engineering value		

Table (1) Parameters as set by factory (initial values) (2/2)

Parameter name	Setting at delivery (Default value)	Setting range	Remarks
Math channel setting	Decimal point position : *****.*	*****, *****.*, *****.**, ***.**, **.****	
	Engineering range (range start/end) 0.0 to 500.0	Engineering value	
	Square rooter : OFF	OFF, ON	
	Input range (range start/end): 0.0 to 1200.0	Engineering value	
	Input filter : 3 seconds	0 to 900 seconds (In increments of 1 second)	
	Subtract channel : None	0 to 72 (No subtraction at 0)	
	PV shift : 0.0	Engineering value -3276.7 to 3276.7	
	PV gain : 100.00%	0.00 to 327.67%	
Math timer setting	H-P, L-P timer cycle : 1 min	1 to 32767min	
	AVG timer cycle : 1 min	1 to 32767min	
	SUM timer cycle : 1 min	1 to 32767min	
Display setting	Display configuration: No. 1 to 9 = ch1 to 9	No.1 to 10, Each provided with ch1 to 72	
F value calculation setting	Decimal point position : *****.*	*****, *****.*, *****.**, ***.**, **.****	
	Manual reset : OFF	OFF, ON	
Totalize setting	Totalize base time : 00:00	00:00 to 23:59	
	Totalize cycle : 1 hour	10, 20, 30 minutes, 1, 2, 3, 4, 6, 12 and 24 hours	
	Weekly base day : Sunday	Sunday to Saturday	
	Monthly base day : 1	1 to 31	
	Start time, Stop time: 00:00 to 00:00	00:00 to 23:59	
	External input : DI1	Digital input, Channel alarm	
Message setting	Message : Blank	Up to 32 characters	
Original unit definition	Unit : Blank	Up to 7 characters	
DI setting	DI function: Function invalid	Function invalid, Rec start/Rec stop, F value calc. reset, Totalize start/stop, Totalize reset, LCD ON	
Constant setting	Constant : 0	-32767 to 32767	
Ethernet setting	IP address : 0.0.0.0	0 to 255	
	Subnet mask : 0.0.0.0	0 to 255	
	Default gateway : 0.0.0.0	0 to 255	
	FTP server function :	OFF, ON	
	FTP access control :	OFF, ON	
	Web server function :	OFF, ON	
	E-mail function :	OFF, ON	
	MODBUS TCP/IP :	OFF, ON	
E-mail setting	SMTP IP address : 0.0.0.0	0 to 255	
	Sender's mail Add : Blank	Up to 64 characters	
	Name : Blank	Up to 32 characters	
	Receiver's mail Add1 to Add8 : Blank	Up to 64 characters	
E-mail trigger setting	Triigger timing : None	None, DI ON, DI OFF, Alarm ON, Alarm OFF, Warning, Timer cycle	
	Alarm Channel : 1	Channel 1 to 72	
	Alarm No. : 1	1 to 4	
	Title : Blank	Up to 32 characters	
	Text1, 2 : Blank	Up to 32 characters	
	PV value affixation :	OFF, ON	
	Receiver's add No. : 1	1 to 8	
	Mail send test :		
User account setting	User name : Blank	Up to 16 characters	
	Password : Blank	Up to 8 characters	
	User Level : Administrator	Administrator, Engineer, Operator, Guest	
Config and record password	Security mode : Password	Password, Logon	
	Password : 0000	0000 to 9999	
	Record Password : 0000	0000 to 9999	

7.2 Outline of parameter setting procedure

Note) The outline of the setting screen is switched by settings of “Security mode” in Item 8.14. If “Logon” is selected in the settings of “Security mode,” the outline of the setting screen is also switched depending on the user level selected when logging on.

(1) Security mode : Password

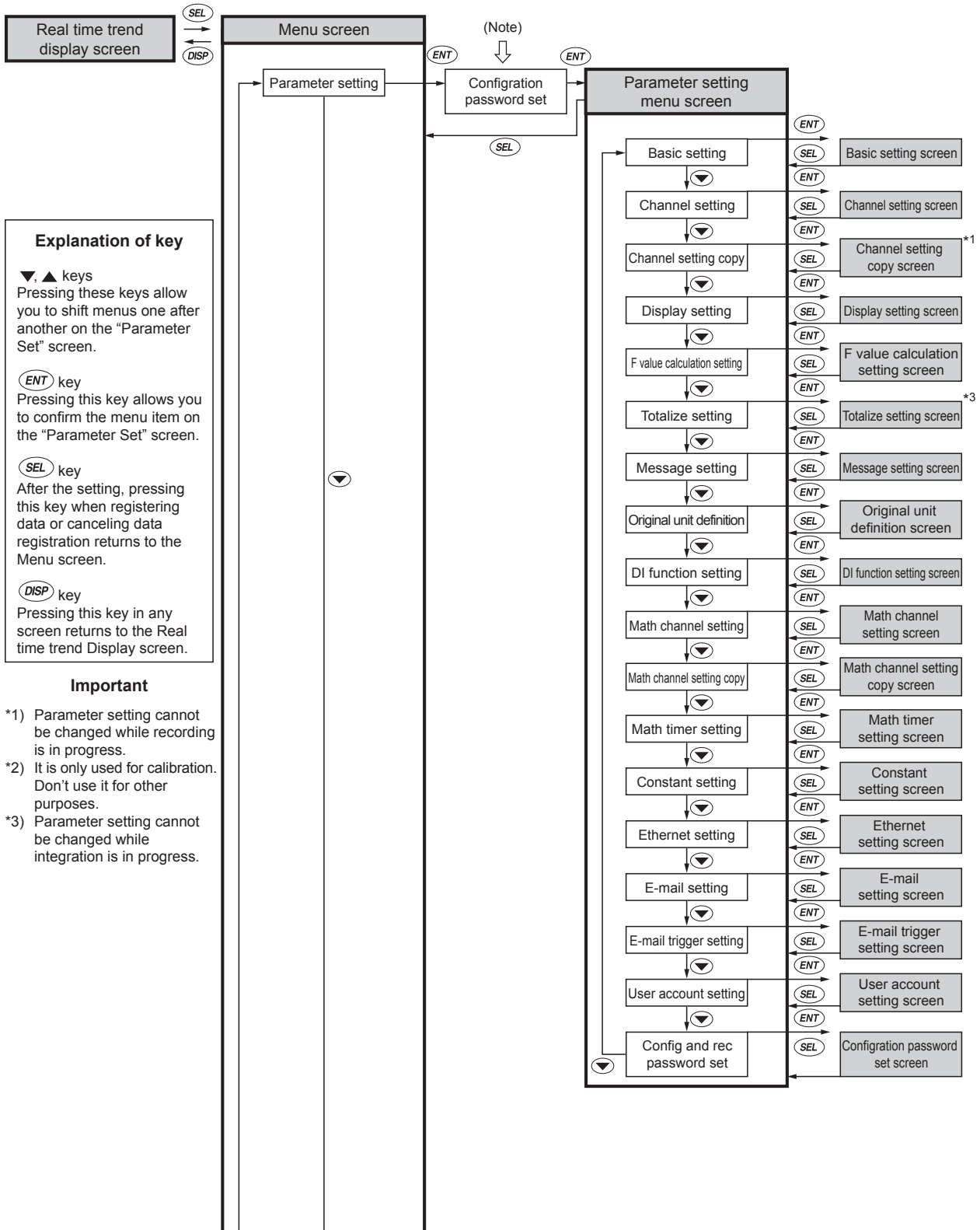

(Continued to the next page)

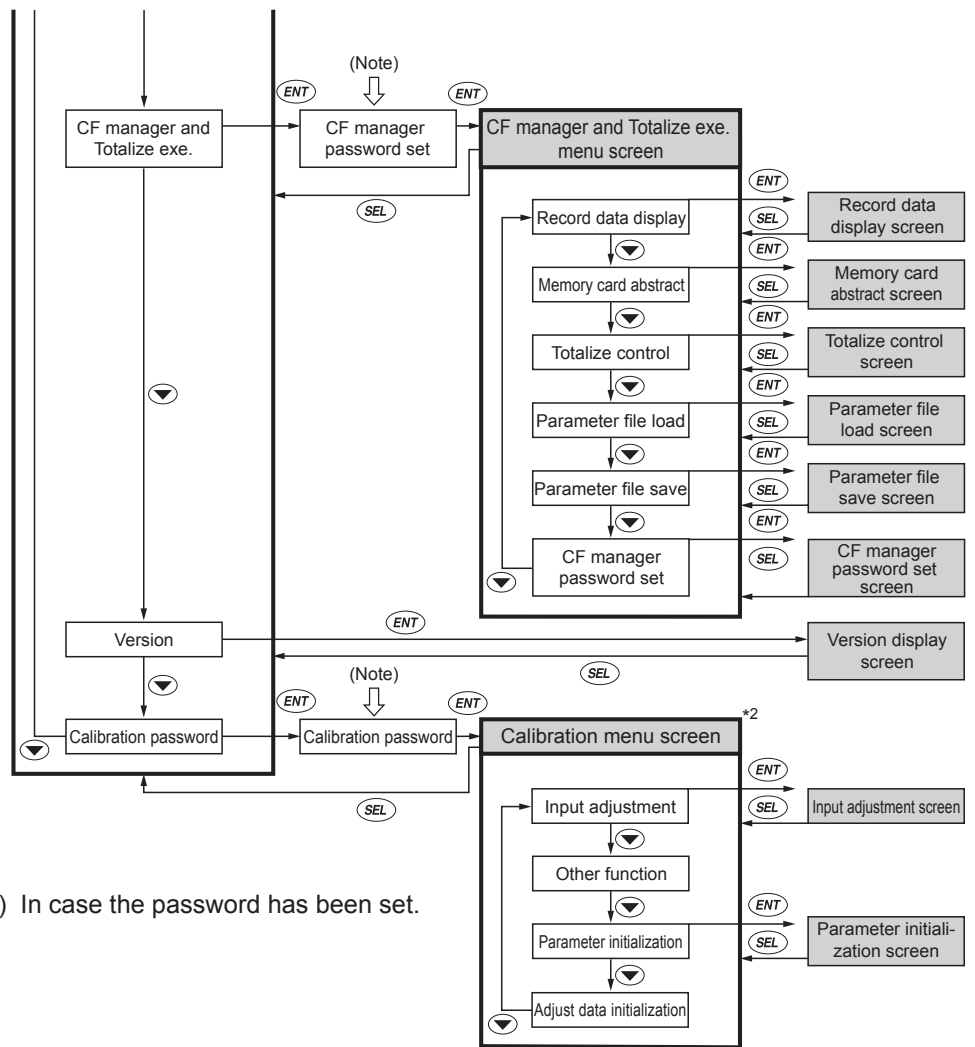

(2)(a) Security mode : Logon, Logon user : None

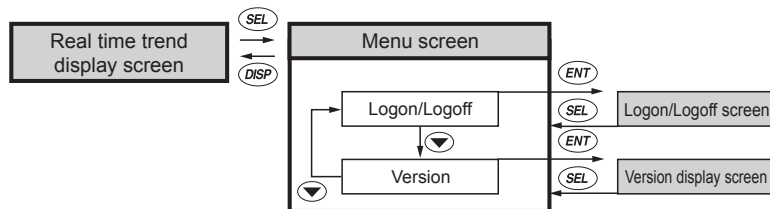

(2)(b) Security mode : Logon, Logon user : Administrator

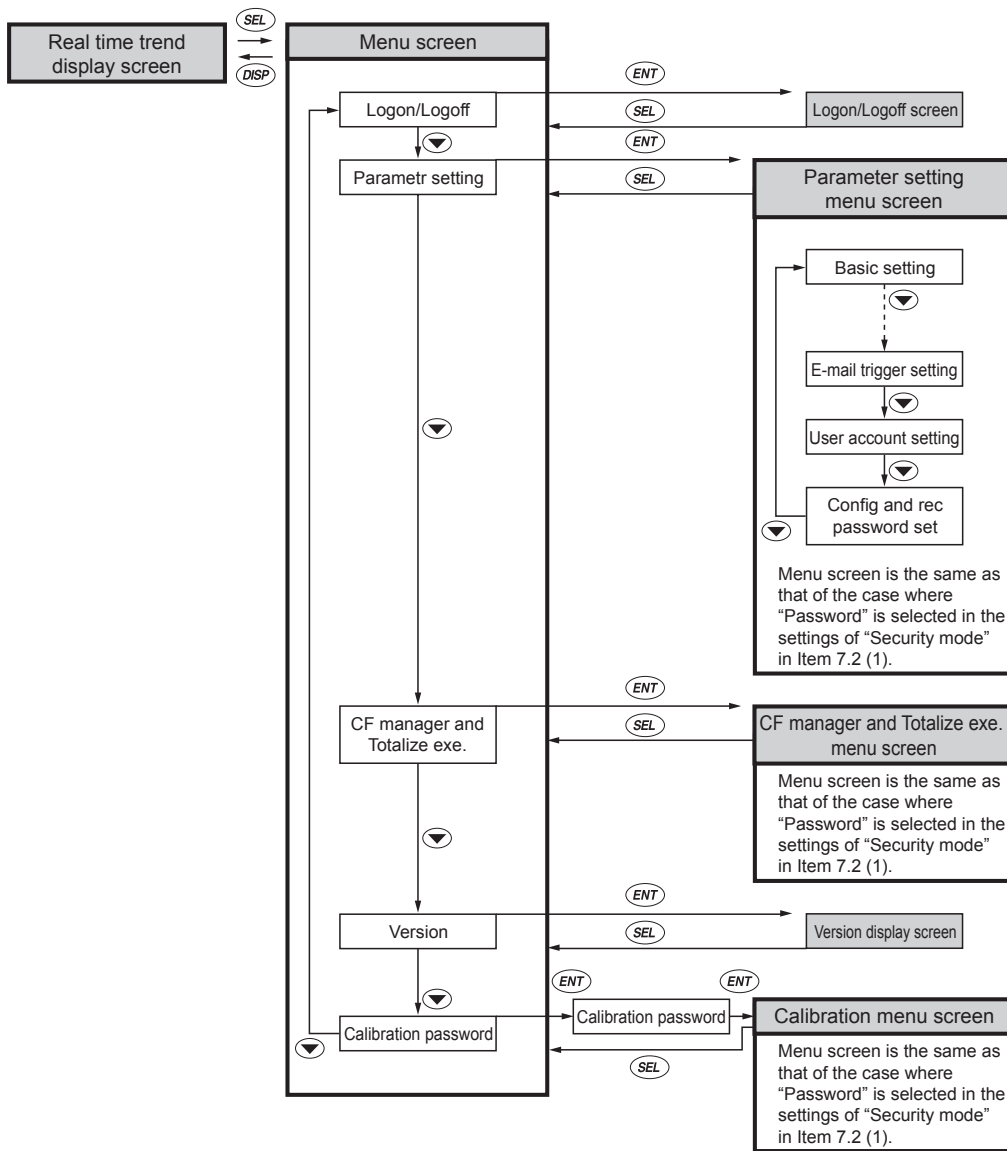

(2)(c) Security mode : Logon, Logon user : Engineer

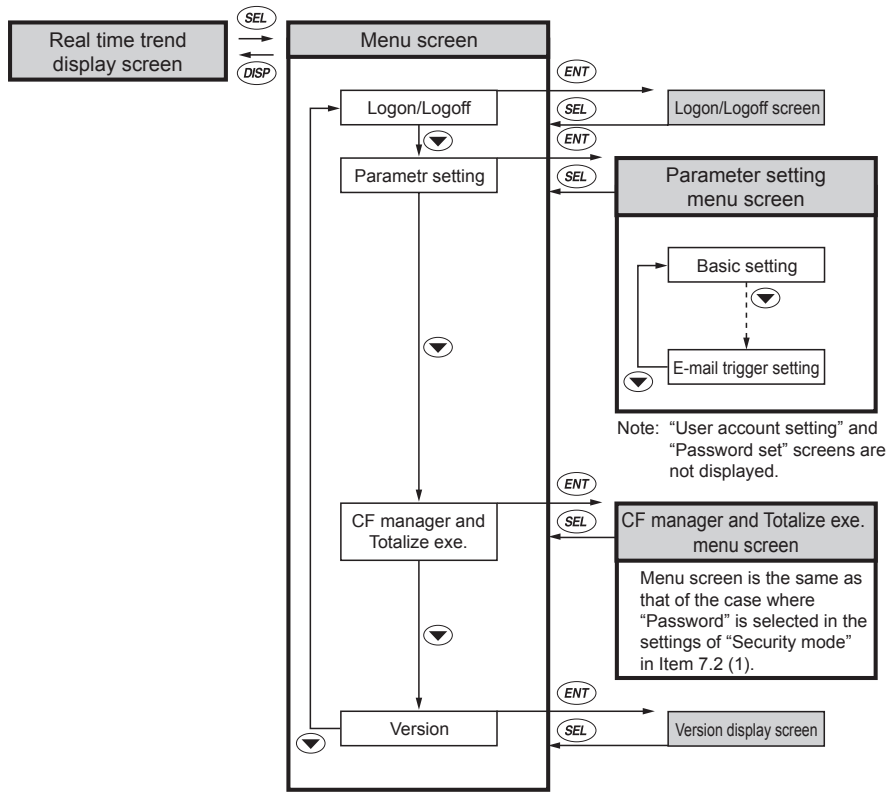

(2)(d) Security mode : Logon, Logon user : Operator and Guest

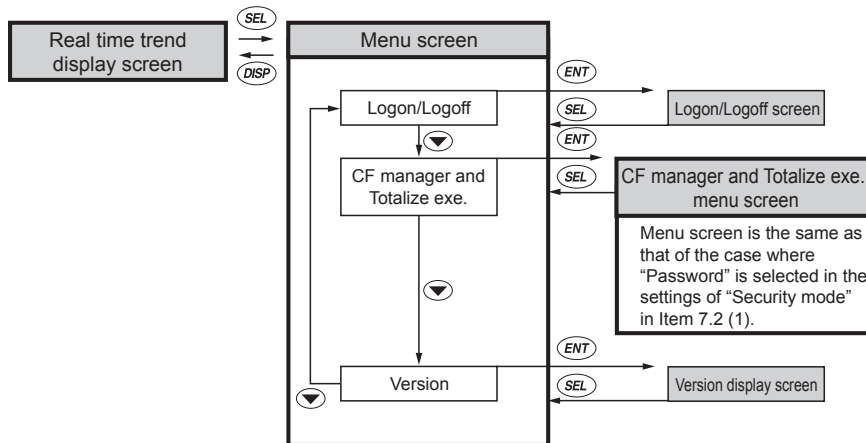

7.3 Basic operation of setting screens

The basic operation of the setting screens is classified in the following 3 methods. In this case, use the up and down keys (▲ and ▼) to move setting items.

(1) Items to be selected with the ▲ or the ▼ key

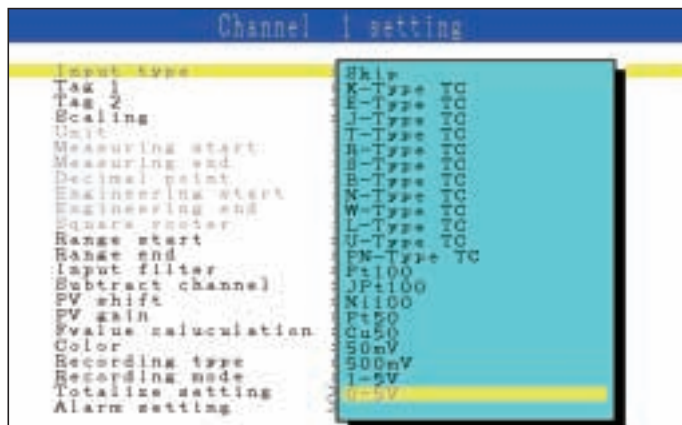

Pressing the ▲ or the ▼ key switches the blinking between items.

Example: To change the input type from K-Type TC (K thermocouple) to E-Type TC (E thermocouple)

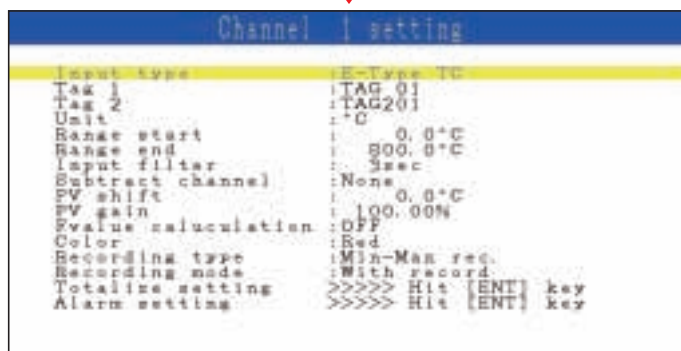
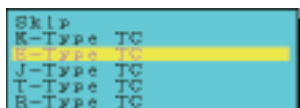
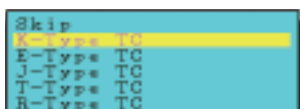
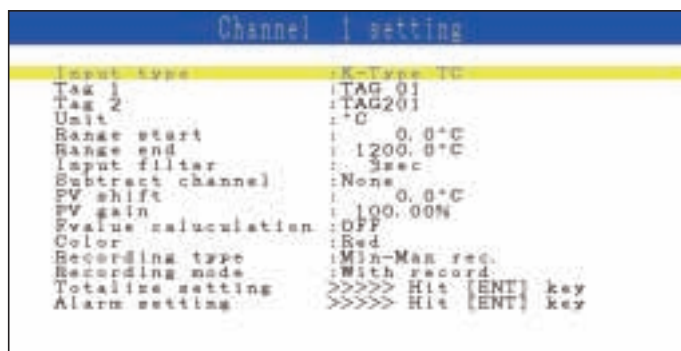

(2) To make the setting by entering numeric values



Select a numerical value using the ▲, ▼, ◀ or the ▶ key and then press the (ENT) key to confirm the entry.

Example: To select 10°C as the lowest temperature of the setting range

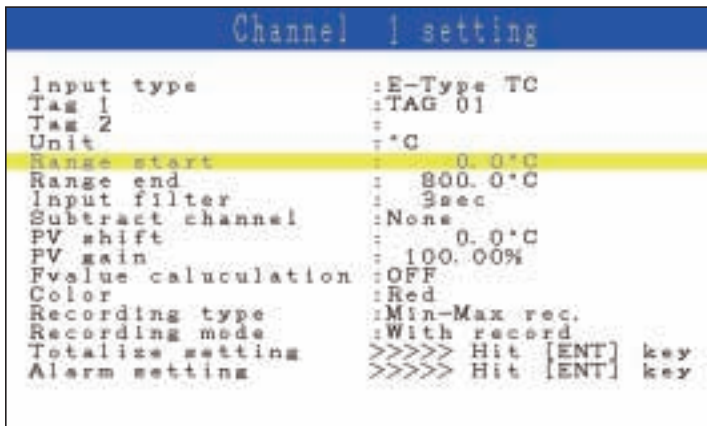

Press the (▶) key three times.



Press the (▲) key once.

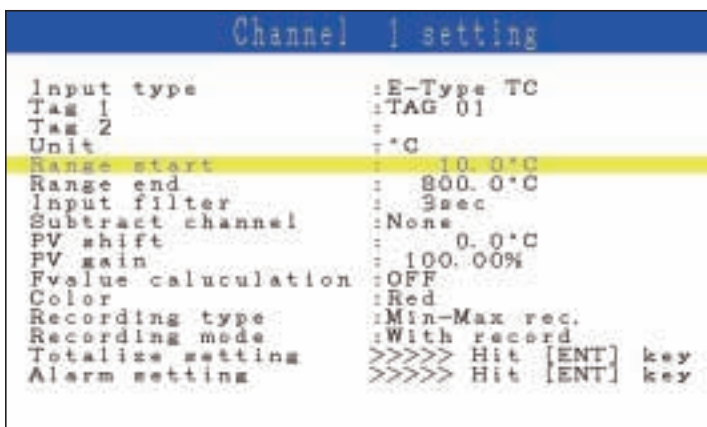

(3) To make the setting by entering characters

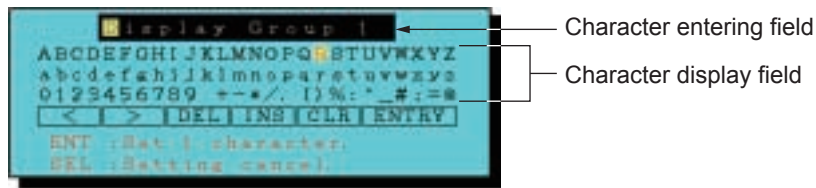

Select a position in the character entering field you want to enter a character by pressing the ◀ or the ▶ key, and then press the (ENT) key.

Select a character in the character display field by pressing the ◀, ▶, ▲ or the ▼ key. The selected character blinks. Then press the (ENT) key.

After entering characters in the character entering field, press the (SEL) key to confirm the entry.

Example: To enter PHU for group screen name

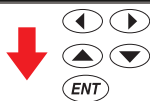
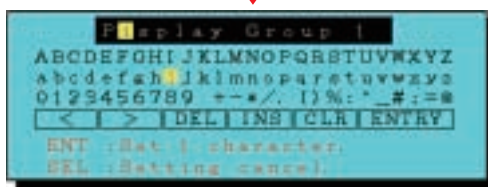
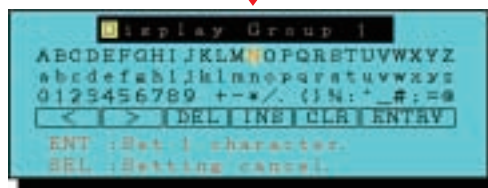
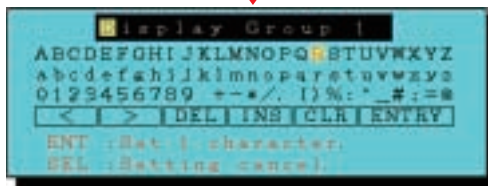
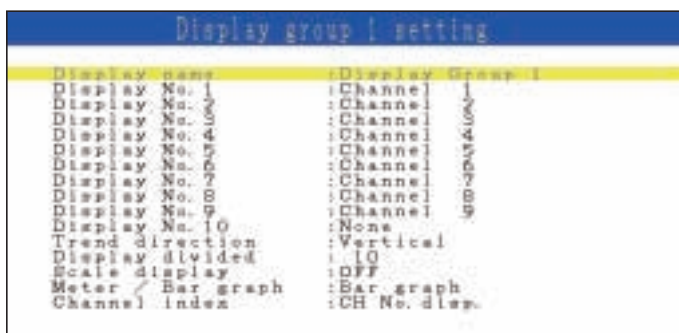



(Move the cursor to "ENTRY" and then press the [ENT] key.)

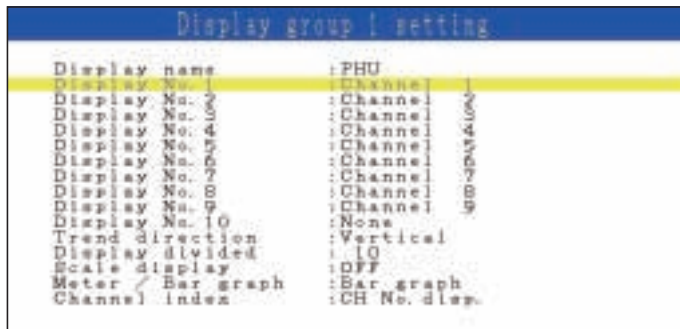

8. SETTING PARAMETERS

8.1 Basic setting

[Explanation]

Follow the procedure shown below to make basic settings (including display refresh cycle, LCD lights out time, MODBUS, and current time) of the recorder main unit.

[Operation]

Move the cursor to “Parameter setting” on the Menu screen and press the **ENT** key, the parameter setting screen appears. If the password has been set, enter the password.

Move the cursor to “Basic setting” and press the **ENT** key, the basic setting screen appears.

The screenshot shows the 'Basic setting' menu with the following parameters and values:

- Refreshment cycle : 1sec
- Display compression : 1/1
- Alarm hysteresis : 0. 20%
- Alarm latch : OFF
- LCD lights-out time : 0min
- Memory full alarm : None
- Battery alarm : None
- File division cycle : No division
- File overwrite : OFF
- Date format : 2007/ 8/15
- Language select : English
- MODBUS Station NO. : 1
- MODBUS baud rate : 19200
- MODBUS parity : Odd
- Record data format : Ascii
- Time setting : 2007/ 8/15 13:55
- Register data : Hit [ENT] key

(NOTE)
When you use the file overwrite function, please operate the file division cycle function.
Please turn on the power supply again when you change the display language.

Arrows on the right side of the screen point to the following descriptions:

- Display refresh cycle setting
- Display compression setting
- Alarm hysteresis setting
- Alarm latch setting
- LCD lights out time setting
- DO setting at the time of memory FULL
- DO setting at the time of battery END
- File division cycle
- File overwrite setting
- Date display format setting
- Language select setting
- MODBUS communication station No. setting
- MODBUS communication baud rate setting
- MODBUS communication parity setting
- Record data format setting
- Current time setting
- Register of data

(1) To set display refresh cycle

Move the cursor to “Refreshment cycle” and press the **(ENT)** key, then the cycle time screen shown below appears.

(Cycle time: 1, 2, 3, 5, 10, 20, 30 seconds, 1, 2, 3, 5, 10, 20, 30 minutes, 1, 2, 3, 4, 6, and 12 hours)



Relationship between “Refresh cycle” and “Chart speed” (on screen) is given below.

Refresh cycle	1 sec	2 sec	3 sec	5 sec	10 sec	20 sec	30 sec
Chart speed (as converted)	1296mm/h	648mm/h	432mm/h	260mm/h	130mm/h	65mm/h	43mm/h

Refresh cycle	1 min	2 min	3 min	5 min	10 min	20 min	30 min
Chart speed (as converted)	22mm/h	11mm/h	7.2mm/h	4.3mm/h	2.2mm/h	1.1mm/h	0.7mm/h

Refresh cycle	1 hour	2 hours	3 hours	4 hours	6 hours	12 hours
Chart speed (as converted)	0.36mm/h	0.18mm/h	0.12mm/h	0.09mm/h	0.06mm/h	0.03mm/h

The first time of the display update is started from 00:00:00 of the following without fail.

(Example)

When refresh cycle is set to 1 min, the next cycle begins at hh : mm : 0 (sec).

Note) If the refresh cycle time is short and a large number of recording files exist, the recording at every refresh cycles may be skipped. Recording files should be limited to 100 or less.

(2) To set display compression

Move the cursor to “Display compression” and press the **ENT** key to display the setting screen. Select the compression ratio in the trend display, and press the **ENT** key.

For example, when the display update cycle is 1 second, the trend display is updated in the cycles shown in the following table.

Compression ratio	1/1	1/10	1/30	1/60
Display time	1 sec	10 sec	30 sec	60 sec

(Note)

1. Compressed display cannot be made in the historical display screen.
2. Compression ratio cannot be changed while recording.



(3) To set the alarm output hysteresis width

Move the cursor to “Alarm hysteresis” and press the **ENT** key. The alarm hysteresis screen appears (as shown below). Enter hysteresis width (0 to 100%) by the cursor key and then press the **ENT** key for confirmation. It is applicable to all types of alarms. The numeric value is expressed as a percentage of the display range for each channel.

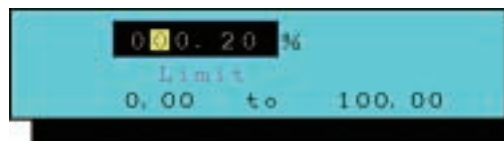

(4) To set alarm latch

Move the cursor to “Alarm latch” and press the **ENT** key, then the alarm latch setting screen appears. Make the setting using the cursor key and press the **ENT** key.

Alarm latch function keeps alarm output turning on even after the cause of the alarm has been removed. To cancel the alarm latch, select it to OFF. Alarm cancel is recorded in the event summary in this case.



(5) To enter LCD lights out time

Move the cursor to “LCD-lights out time” and press the **ENT** key, then the LCD lights out time setting screen appears.

Make the setting (0 to 60 minutes) using the cursor key and press the **ENT** key.

The LCD is kept on at all times by entering 0 minute.

* Press any key to turn on the LCD.



(6) To make DO setting at the time of memory FULL

Move the cursor to “Memory full alarm” and press the **(ENT)** key, then the DO output setting screen appears. Select desired DO output No. using the cursor key and press the **(ENT)** key.

DO output works when memory FULL is detected. Select “None” not to use this function.

Note) DO21 to 36 are open collector outputs and not relay outputs.

Note) “Memory full alarm” is turned on when the remaining memory reaches 0%. This value cannot be set.

Note) When memory card is removed, DO output turns off. But the message of memory card full does not appear. Press the **(DISP) or **(SEL)** key, it appears.**



(7) To make DO setting at the time of battery END

Move the cursor to “Battery alarm” and press the **(ENT)** key, then the DO output setting screen appears.

Select desired DO output No. using the cursor key and press the **(ENT)** key.

DO output functions when the battery END is detected. Select “None” not to use the function.

When battery END is detected, a message is displayed on the trend screen.

Note) DO21 to 36 are open collector outputs and not relay outputs.

(8) Setting the file division cycle

Move the cursor to “File division cycle” and then press the **(ENT)** key to display the File division cycle setting screen.

If “No division” is selected, the archived file is not divided automatically.

If “1 hour,” “1 day” or “1 week” is selected, the archived file is divided hourly, daily or weekly from the start of recording.

If “1 month” is selected, the archived file is divided at 0:00 on the first day of every month.

Note 1) If the “File division cycle” setting is shorter than the “Refreshment cycle” setting, the archived file without data is created.

Note 2) If “1 hour,” “1 day” or “1 week” is selected as the file division cycle, the number of data of the first file is one larger than that of the second and the subsequent files.

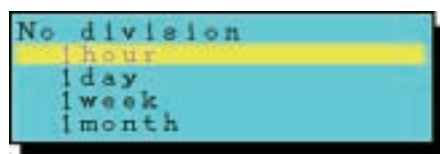

(9) Setting the file overwrite

Move the cursor to the “File overwrite” and press the **(ENT)** key for setting.

If the overwrite function in the archived file is turned ON, the oldest file is deleted and the new record files are kept when the compact flash becomes full while recording.

The overwrite function on the archived file operates as follows.

- When the remaining capacity of compact flash is 1MB or less, the oldest file is deleted.
- The maximum number of record files is 1350 pieces. If the number of file exceeds 1350, the oldest file is deleted regardless of the remaining capacity of flash memory.
- When the available capacity (the capacity of the deletable record file included) is less than 10MB, the overwrite function in the archived file does not operate.

(Note)

The overwrite function in the archived file stops recording as in CF FULL in the same state when the split function in the archived file is not operating, or when only one file is kept in the compact flash even though the split function is operating.



(10) Date display format setting

The display format of dates that appear on the data display screen can be selected.

On the Basic setting screen, move the cursor to “Date format” and then press the **(ENT)** key, and the display format select screen appears.

Move the cursor to the display format to be selected, and then press the **(ENT)** key.

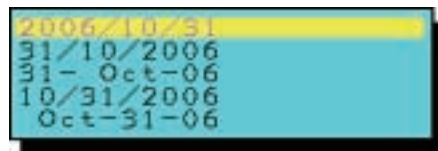

(11) Setting the language select

Move the cursor to “Language select” and press the **(ENT)** key to select a language.

When a language is switched to another, a language in the Web screen and E-mail is switched accordingly.



(12) To select a station No. for MODBUS communication

Move the cursor to “MODBUS station No.” and press the **(ENT)** key, then the station No. setting screen appears.

Select desired MODBUS station No. (0 to 255) using the cursor key and press the **(ENT)** key. When set 0 to this parameter, communication does not work.



(13) To select baud rate for MODBUS communication

Move the cursor to “MODBUS baud rate” and press the **(ENT)** key, then the baud rate setting screen appears.

Select desired RS-485 MODBUS communication baud rate (from 9600 and 19200 bps) using the cursor key and press the **(ENT)** key.



(14) To select parity bit for MODBUS communication

Move the cursor to “MODBUS parity” and press the **(ENT)** key, then the parity bit setting screen appears.

Select desired RS-485 MODBUS parity bit (from None, Odd and Even) using the cursor key and press the **(ENT)** key.



(15) To select front communication setting (for loader)

Move the cursor to “Front communication” and press the **(ENT)** key, then the front communication setting screen appears.

Select “ON” when this recorder is connected to a loader cable.

(16) To set record data format

Move the cursor to “Record data format” and press the **(ENT)** key, then the data format setting screen appears.



Select either ASCII or Binary as data recording format.

Each format has the following characteristics.

ASCII format

- Allows the recorded data to be opened directly on Excel or using text editor.
- The number of data that can be recorded is relatively small (approximately 1/4 of those recorded in binary format)

Binary format

- The recorded data cannot be opened directly on Excel or using text editor.
The recorded data can be opened using the attached data viewer software, and then by converting it to CSV file, it can be opened on Excel or the using text editor.
- The number of data that can be recorded is relatively large (approximately 4 times of those recorded in ASCII format).

(17) To select time

Move the cursor to “Time setting” and press the **(ENT)** key, then the time setting screen appears.
Select desired time, year, month, hour and minute, using the cursor key and press the **(ENT)** key.

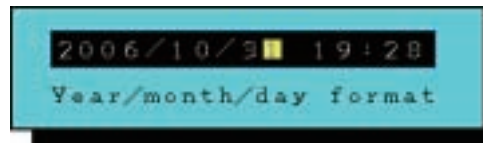

- | |
|--|
| <p>Reference 1: The clock is set to the current time of Japan Standard Time by the factory at shipment.
Since it is backed-up by a lithium-ion battery, it is always running with power interruption or power OFF. The lithium battery has a service life of about 10 years at normal temperature of 25°C.</p> <p>Reference 2: The time scale is divided into 24 hours. The range is set from 00: 00 to 23: 59.</p> <p>Reference 3: A “second” is not settable. But, the inside of the clock is treated as follows. After setting the “minute”, press the (ENT) key at the “Adjust” position. Then, the clock runs with the second counter set to 0.</p> |
|--|

(18) Registering method of set values (saving to flash memory)

Move the cursor to “Register data” and press the **(ENT)** key, PHU registers the set value to the flash memory.

- Note 1)** When the parameter memory lamp blinks in red, it indicates that set parameters are not registered to the flash memory. Operate in accordance with above (16) to register to flash memory.
- Note 2)** After parameters have been set, operate in accordance with above (16). Otherwise, the set values returns to original values when turning OFF power.

8.2 Channel settings

[Explanation]

Follow the procedure shown below to select input type, unit, scaling, input filter (time constant), PV shift, PV gain, subtraction, F value calculation, color, TAG No., recording type, recording mode, totalizing setting and alarm setting for each channel.

[Operation]

Move the cursor to “Parameter setting” on the Menu screen and press the **(ENT)** key. If the password has been set, enter the password, and the parameter setting screen appears.

Move the cursor to “Channel setting” and press the **(ENT)** key, then channel setting screen appears.

On this screen, select desired channel number and press the **(ENT)** key. Following screen appears.

The screenshot shows the 'Channel 1 setting' screen with the following settings and their corresponding labels:

Setting	Value	Label
Input type	:0-5V...	Input type setting
Tag 1	:TAG 01	TAG No. setting
Tag 2	:	
Scaling	:OFF	Scaling setting
Unit	:V	Unit setting
Measuring start	: 0.000V	Measurement range setting
Measuring end	: 5.000V	
Decimal point	:......	Decimal point position setting
Engineering start	: 0.000V	Engineering value setting
Engineering end	: 5.000V	
Square rooter	:OFF	Square root calculation setting
Range start	: 0.000V	Display range setting
Range end	: 5.000V	
Input filter	: 3sec	Input filter setting
Subtract channel	:None	Subtraction channel setting
PV shift	: 0.000V	PV shift value setting
PV gain	: 100.00%	PV gain setting
Fvalue caluculation	:OFF	F value calculation function setting
Color	:Red	Display color setting
Recording type	:Min-Max rec.	Recording type setting
Recording mode	:With record	Recording mode setting
Totalize setting	>>>> Hit [ENT] key	Totalizing setting
Alarm setting	>>>> Hit [ENT] key	Alarm setting

(1) To set input type

Move the cursor to “Input type” and press the **(ENT)** key, then the following input type selection screen appears. Select any input signal by using the cursor key and press the **(ENT)** key. If you don’t want to perform “indication”, “recording”, and “alarm” operation, select “Skip”.

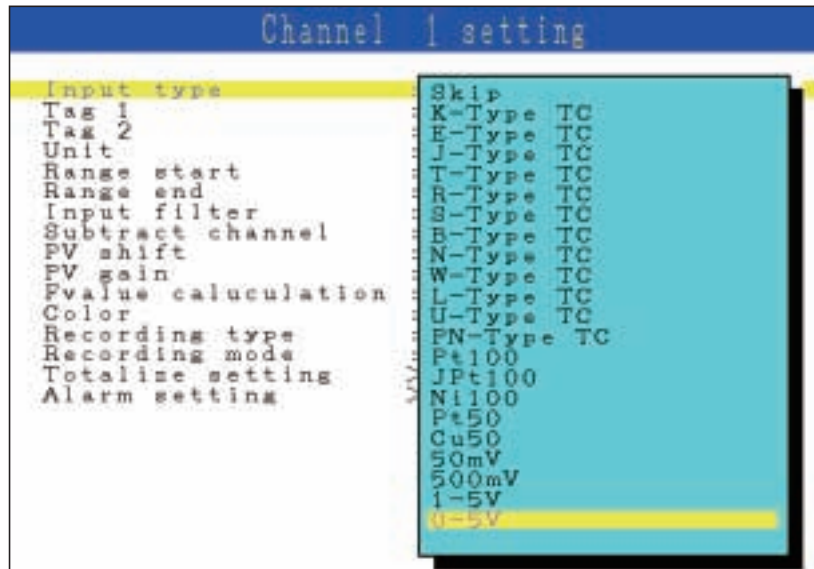

- Note 1)** When the “Input type” is set to “Skip”, indication, recording and alarm for the channel are not carried out.
- Note 2)** After the change of the “Input type”, wait for a while until the measured value stabilizes.
- Note 3)** When the recorder is in recording, the “Input type” cannot be changed.

Note) About input type setting

Basically, the input type can be every 2 channels.

The input type of channel 2, 4, 6, 8, 11, 13, 15 and 17 can only be set in the same category of previous channel.

If “Skip” has been selected for the previous channel, arbitrary input type can be selected.

The following input types are available.

Input type	Details
Thermocouple, 50mV	K, E, J, T, R, S, B, N, W, L, U, and PN thermocouples, 50mV
Resistance bulb	Pt100, JPt100, Ni100, Pt50, Cu50
500mV	500mV
5V	1 to 5V, 0 to 5V

Note, however, that arbitrary input type can be selected only for channels 9 and 18 irrespective of the type allocated to other channels. For example, if the input type 1 to 5V is selected for channel 1, the following screen appears as the input type selection screen for channel 2, which allows only 1 to 5V, 0 to 5V, or Skip to be selected.



The sample of input type setting

	Input type	Input type	Description
Channel 1	K thermocouple	Thermocouple, 50mV	The type of thermocouple can be arbitrarily selected for each channel.
Channel 2	T thermocouple		
Channel 3	1 to 5V	5V	
Channel 4	0 to 5V		
Channel 5	Pt100	Resistance bulb	The type of resistance bulb can be arbitrarily selected for each channel.
Channel 6	JPt100		
Channel 7	500mV	500mV	
Channel 8	500mV		
Channel 9	J thermocouple	Thermocouple, 50mV	Input type can be arbitrarily selected for channel 9.
Channel 10	K thermocouple	Thermocouple, 50mV	The input type of the thermocouple and 50mV is the same.
Channel 11	50mV		
Channel 12	Skip	5V	Skip can arbitrarily selected irrespective of the input type.
Channel 13	1 to 5V		
Channel 14	Pt100	Resistance bulb	
Channel 15	Skip		
Channel 16	Skip	500mV	
Channel 17	500mV		
Channel 18	50mV	Thermocouple, 50mV	Input type can be arbitrarily selected for channel 18.

(2) To set TAG 1 and TAG 2

• TAG 1

Move the cursor to “Tag 1” and press the **(ENT)** key, then “TAG Setting” screen appears as shown below. Enter the TAG name by using the cursor key and press the **(ENT)** key for confirmation. After entry of the TAG name, press the **(SEL)** key to register the data.

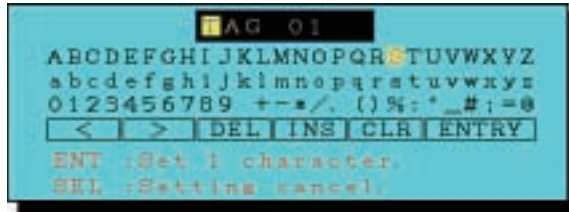

Up to 8 characters can be entered. Note, however, that on some screens such as trend screen, only 7 characters can be displayed.

• TAG 2

Tag 2 is displayed on the screen for 4 channels.

To display at the TAG display area on trend display screen is selectable by parameter, “Channel index”.

Regarding to setting method, refer to 8.6 (7), “To select channel index”.

(3) To set scaling

With DC voltage input, set scaling “ON” “OFF” with the cursor key.

Note) When scaling is set to “ON”, the recording range is zero-cleared. For details, refer to Item 8.2 (9) “To set display range”.

(4) To set units

Units can only be set when the scaling is set to “ON”.

Move the cursor to “Unit” and press the **(ENT)** key, then “Unit menu” screen (below) appears.

Select any unit on the screen by using the cursor key, and press the **(ENT)** key.

Unit select screen varies depending on the input type. (The following figure is the case of DC voltage input.)

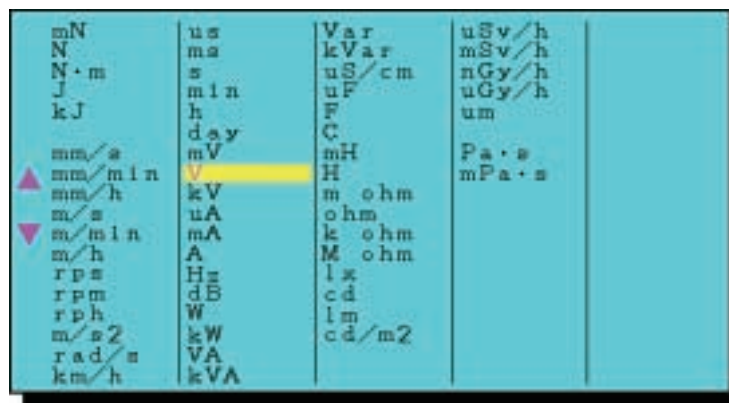

Unit code

Temperature · humidity	Flow rate				Pressure		Level-Height	Capacity · Weight · Area	
°C	t/d	t/h	t/min	t/s	mbar	mPa	mm	ml	mm ²
°F	kg/d	kg/h	kg/min	kg/s	bar	Pa	cm	l	cm ²
%RH	g/d	g/h	g/min	g/s	N/mm ²	kPa	m	kl	m ²
vol%	m ³ /d	m ³ /h	m ³ /min	m ³ /s	N/m ²	MPa		mm ³	g
	l/d	l/h	l/min	l/s				cm ³	kg
								m ³	t

Density		Analysis			Power · Acceleration			Time	Electro-magnetism
g/cm ³	g/l	ppm	ppmNO _x	%CO ₂	mN	mm/s	rps	s	mV
kg/cm ³	kg/l	ppmNH ₃	ppb	%He	N	mm/min	rpm	ms	V
g/m ³	g/ml	ppmSO ₂	pH	%Ar	N · m	mm/h	rph	s	kV
kg/m ³		ppmH ₂ S	mol	%O ₂	J	m/s	m/s ²	min	μA
		ppmCO	%	%NaCl	kJ	m/min	rad/s	h	mA
		ppmO ₂	%H ₂	%CO		m/h	km/h	day	A

Electromagnetism			Heat · Light	Radiation	Other	Customer-made (Note 2)	
Hz	Var	mH	lx	μSv/h	Pa · s	(Unit 1)	(Unit 7)
dB	kVar	H	cd	mSv/h	mPa · s	(Unit 2)	(Unit 8)
W	μS/cm	m ohm	lm	nGy/h		(Unit 3)	(Unit 9)
kW	μF	ohm	cd/m ²	μGy/h		(Unit 4)	(Unit 10)
VA	F	k ohm		μm		(Unit 5)	(Unit 11)
kVA	C	M ohm				(Unit 6)	(Unit 12)

Note 1) Blank consists of some spaces

Note 2) Units can be made by the customer (See Item 8.10).

(5) To enter the measuring range

The measuring range can be set only when the scaling is set to ON at voltage input type.

To display the measuring range setting screen, move the each cursor to “Measuring start” or “Measuring end” and press the **ENT** key. Enter the measuring range by using the cursor key and press the **ENT** key for confirmation.

“Measuring start” means low limit, while “Measuring end” means high limit.

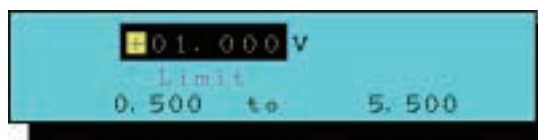

(6) To set the decimal point position

Decimal point position can be set only when scaling is set to ON at voltage input type.

Move the cursor to “Decimal point” and press the **ENT** key, then the following decimal point position setting screen appears. Select desired decimal point position using the cursor key and press the **ENT** key for confirmation.



(7) To enter the engineering unit

The engineering unit can be set only when the scaling is set to ON at voltage input type.

To display the engineering unit setting screen, move the cursor to “Engineering start” or “Engineering end” and press the **ENT** key. By using the cursor key and press the **ENT** key for confirmation.

“Engineering start” means lower limit, “Engineering end” means upper limit.

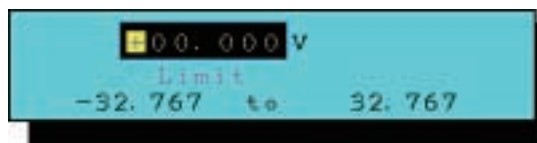

(8) To enter square rooter (rooter)

Square rooter “ON” and “OFF” can be set by using the cursor key in the case of DC voltage input.

Description of square rooter

The measuring range is set to 0 to 100%. For example, in case of DC1 to 5V input, 1V is 0% and 5V is 100%, and square rooter is performed against this percentage value. Refer to example below.

If the input value converted to percentage is minus, the result of square rooter should be 0%.

The data after the square rooter (0 to 100%) is converted to industrial value with the obtained data regarded as 0 to 100% of the engineering unit.

Example: In the case of the following input setting, the readings for the input values are as follows:

Input type: 1 to 5V
Measuring range: 1 to 5V
Industrial value: 0 to 1000 (t/h)

	Reading
When input is 1V (0%)	$(1000-0) \times \sqrt{0} = 0$ (t/h)
When input is 3V (50%)	$(1000-0) \times \sqrt{0.5} = 707$ (t/h)
When input is 5V (100%)	$(1000-0) \times \sqrt{1} = 1000$ (t/h)
When input is 0.6V (-10%)	$(1000-0) \times \sqrt{-0.1} \rightarrow 0$ (t/h)

(9) To set display range

Move the each cursor to “Range start” or “Range end” and press the **ENT** key, then, the “Range setting” screen appears as shown below. Enter the range by the cursor key, and press the **ENT** key for confirmation.

For the setting range, refer to Table 1, “Display Range Set Range”.

<In case of input type is thermocouple or Pt>

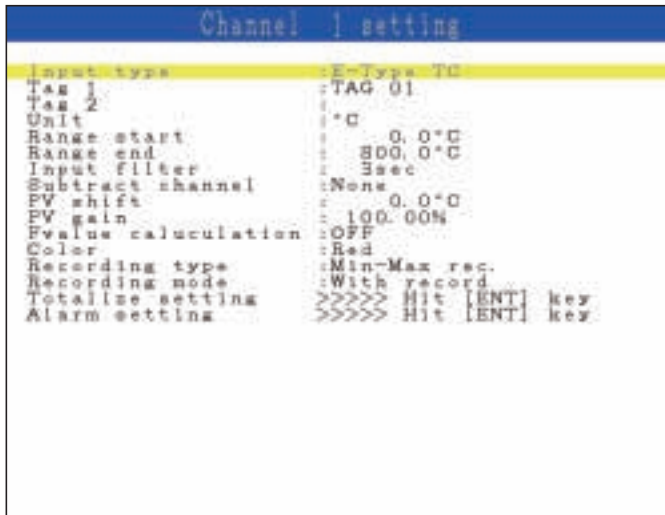

<In case of input type is voltage input>



Table 1 Display Range Set Range

Type		Input range	Record range set range
Thermocouple	B	400 to 1760°C	370.0 to 1790.0°C
	R	0 to 1760°C	- 30.0 to 1790.0°C
	S	0 to 1760°C	- 30.0 to 1790.0°C
	K	-200 to 1370°C	-230.0 to 1400.0°C
	E	-200 to 800°C	-230.0 to 830.0°C
	J	-200 to 1100°C	-230.0 to 1130.0°C
	T	-200 to 400°C	-230.0 to 430.0°C
	N	0 to 1300°C	- 30.0 to 1330.0°C
	W	0 to 1760°C	- 30.0 to 1790.0°C
	L	-200 to 900°C	-230.0 to 930.0°C
	U	-200 to 400°C	-230.0 to 430.0°C
PN	0 to 1300°C	- 30.0 to 1330.0°C	
Resistance bulb	JPt100	-200 to 600°C	-230.0 to 630.0°C
	Pt100	-200 to 600°C	-230.0 to 630.0°C
	Ni100	-60 to 180°C	-90.0 to 210.0°C
	Pt50	-200 to 600°C	-230.0 to 630.0°C
	Cu50	-50 to 200°C	-80.0 to 230.0°C
DC voltage		0 to + 50mV	- 10.00 to + 55.00mV
		0 to +500mV	- 10.0 to + 550.0mV
		+ 1 to + 5V	+ 0.500 to + 5.500V
		0 to + 5V	- 0.100 to + 5.500V

(10) To set input filter (primary delay filter)

Move the cursor to “Input filter” and press the **ENT** key, then small window appears. Select numerical values by using the cursor key.

Input filter range: 0 to 900 sec (step of 1 sec)



(11) To select subtraction channel

Move the cursor to “Subtract channel” and press the **ENT** key, then small window appears. Select the channel No. for which subtraction is to be performed using the cursor.

[Subtraction function]

- The result of subtraction of the values for 2 channels is recorded to the channel to be set.

Example: When the result of ch1-ch2 is recorded to ch1

$$\text{ch1}=\text{ch1}-\text{ch2}$$

- Be sure to perform subtraction between the channels having the same unit and decimal point position. Otherwise the record cannot be guaranteed.
- Subtraction is not performed when “none” is selected.
- Limit doesn't work for the result of subtraction.

(12) To set PV shift value

Move the cursor to “PV shift” and press the ENT key, then “PV shift” screen appears as shown below.

Enter PV shift value by using the cursor key and press the ENT key.

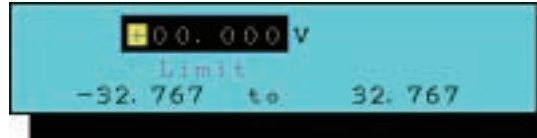

[PV shift function]

- Measured values can be calculated, recorded, and displayed with the PV shift constant.
- PV shift calculation can be achieved with the gain and shift values.

Conversion graphs relating to shift calculation and gain calculation are shown below.

• Shift calculation

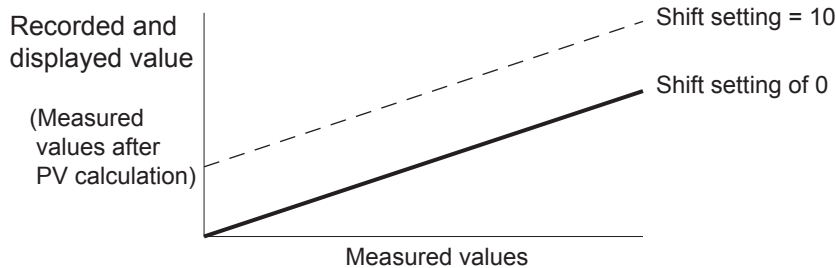

• Gain calculation

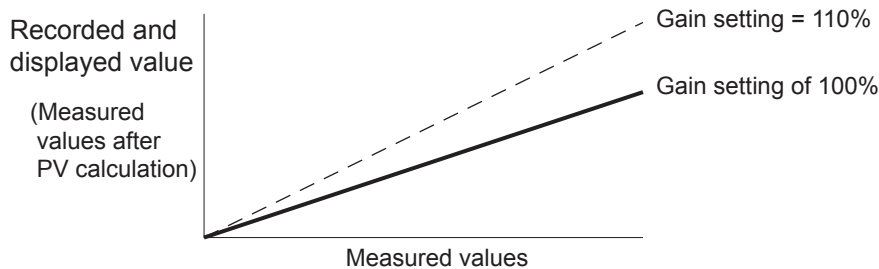

- PV shift is calculated as follows;

$$P' = AP + B$$

Where,

P': Measured value after calculation of PV shift

P : Measured value

A : Gain (0.00 to 327.67%)

B : Shift values (setting range: -32767 to 32767 engineering unit, decimal point depends on input type)

* The measured value after PV shift calculation is limited so that it falls within the settable record range by input type set for each channel. The judgement of input error (such as Burnout, Error, and Over) is performed against the input and not for the result of shift or gain calculation.

- If input type is changed or the scaling function is turned ON/OFF, the PV shift set value for the channel is cleared. (If the scaling function is turned ON/OFF by the setting copying function, the PV shift set value for the channel is not cleared.)
- The Copy function allows you to copy set values, but it is not provided with a means of making copy of PV shift set values.

(13) To set PV gain

Move the cursor to “PV gain” and press the **ENT** key, then the “PV gain” screen appears as shown below.

Enter PV inclination by using the cursor key and press the **ENT** key.

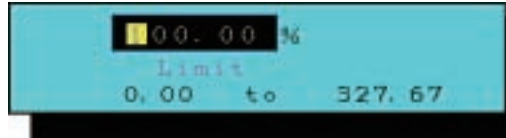

(14) F value calculation function

Select F value calculation “ON” or “OFF” using the cursor.

Note that if “ON” is selected, calculation is performed according to the selection made in Item 8.7 “Setting method of F value calculation.”

[F value calculation function]

From the measured temperature, the extinction value of bacteria by sterilization by heating can be calculated.

F value calculation formula

$$F \text{ value} = \sum \frac{10^{\frac{(T-T_0)}{Z}}}{60}$$

T : Measured temperature
T₀ : Reference temperature
Z : Z value

- F value calculation is performed by the second.
- The measured temperature of the channel for which F value calculation is performed cannot be recorded.
- The unit field of the channel for which F value calculation is performed is kept blank, and the decimal place is set to the one designated in F value calculation setting screen that is common to all channels.
- The constants to be used for F value calculation (reference temperature, Z value, and decimal point position) are common to all channels.
- F value calculation can be reset manually or by DI or temperature setting.
- If input is abnormal, an error (such as Over, Under, Burnout, Error) is displayed, but 0 is recorded.

(15) To set display color

Move the cursor to “Color” and press the **(ENT)** key, then the following color selection window appears. Select the display color using the cursor and press the **(ENT)** key.



(16) To set recording type

Move the cursor to “Recording type” and press the **(ENT)** key, then the following recording type selection screen appears. Select a desired recording type using the cursor key, and then press the **(ENT)** key.

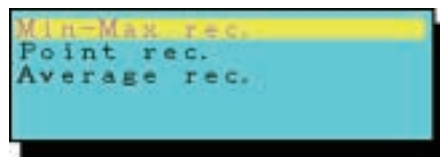

[About recording type]

Recording type can be selected from the following three.

- Point value recording: Records the instantaneous measurement value at every display refresh cycle.
- Average value recording: Records the average measurement value during the display refresh cycle at every display refresh cycle.
- Maximum/minimum recording: Records the maximum/minimum measurement value during the display refresh cycle at every display refresh cycle.

* Longer recording is allowed with instantaneous and average value recording than with maximum/minimum value recording.

(17) To set recording mode

Move the cursor to “Recording mode” and press the **(ENT)** key, then recording mode screen appears.

Select either “With record” or “Display only” by the cursor.

When setting “Display only”, trend display on the Trend screen and history display on the Historical screen are not carried out. Further, nothing is recorded except for display of measured values.

(18) Totalize setting

Move the cursor to “Totalize setting” and press the **(ENT)** key, then the following totalizing setting screen appears.

Select the item to be set using the cursor key and then press the **(ENT)** key.

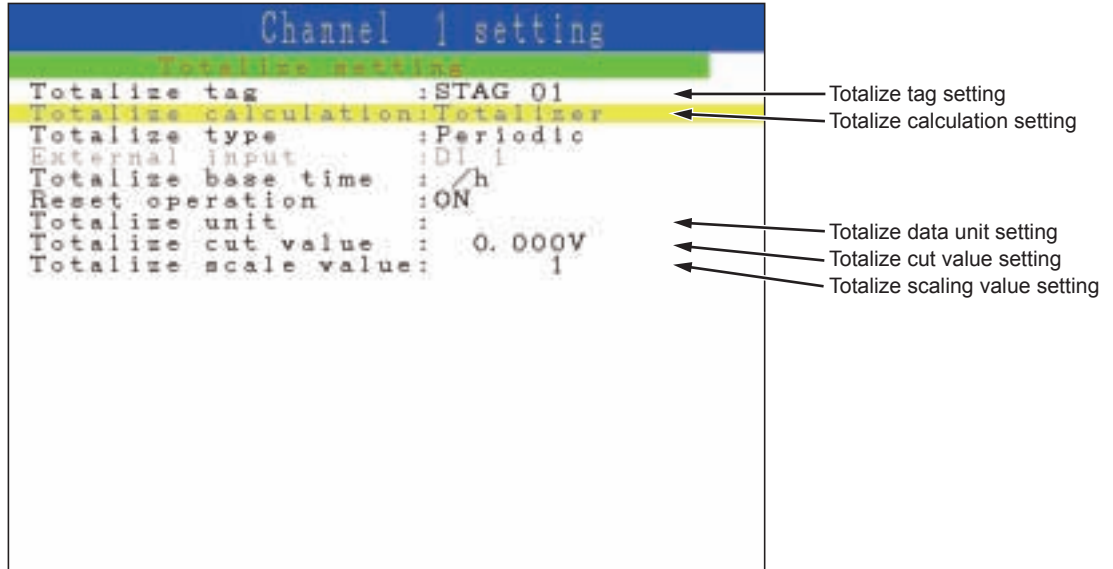

(a) To set totalize tag

Move the cursor to “Totalize tag” and by press the **(ENT)** key, then the following character entry screen appears. Enter the tag name by using the cursor key and press the **(ENT)** key. When entry is completed, press the **(SEL)** key to register the entry.

- Totalize tag is recorded in totalize recording result and displayed on the totalize display screen.



(b) To set totalize calculation

Either “Totalizer,” “Counter,” or “Timer” can be selected as “Totalize calculation.”

- a) Select “Totalizer” to perform totalize function of creating daily and monthly reports.
- b) Select “Counter” to record the number of times of DI ON or alarm ON during the totalize period. The value to the right of decimal point is discarded.
- c) Select “Timer” to record the duration of DI ON or alarm ON during the totalize period.

In all of the above cases, time is displayed based on the time set in a parameter, “Totalize base time,” with all digits to the right of the decimal point discarded.

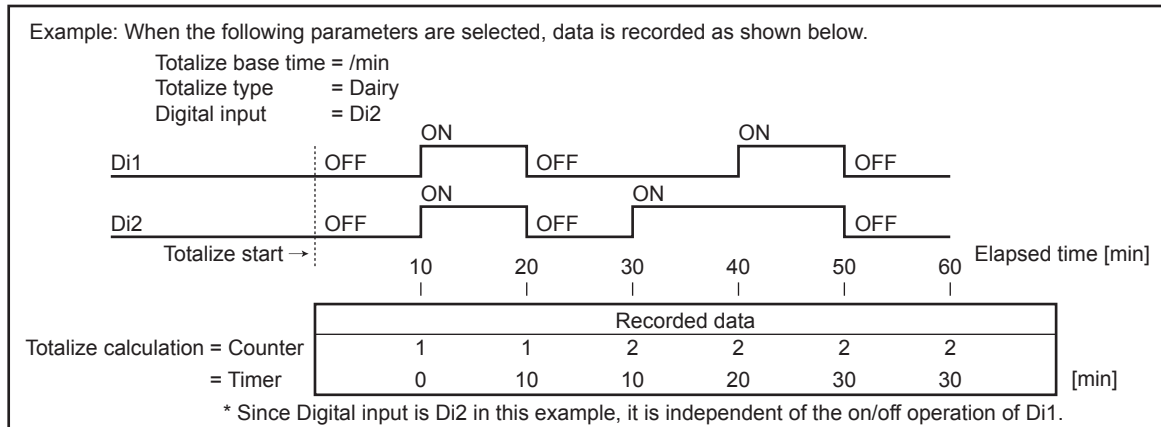

(c) To set totalize type

Select one from daily report, weekly report, monthly report, annual report, continuous totalizing, and daily report (at designated time) in “Totalize type.” Refer to the following table for the totalize operation of each selection.

Periodic report	Totalized value is recorded (and reset) at every totalize cycle that has been set. The totalize cycle is from one totalize base time to another.
Daily report	Totalized value is recorded (and reset) at totalize base time every day.
Weekly report	Totalized value is recorded (and reset) weekly at totalize base time of the specified day of the week.
Monthly report	Totalized value is recorded (and reset) monthly at totalize base time of the specified day of the month.
Annual report	Totalized value is recorded (and reset) annually at totalize base time on January 1st.
Daily report (at designated time)	Totalizing is performed from the start time to the stop time every day, and on completion of the operation, totalized value is recorded (and reset).
External input	Totalize operation is performed during the period from the external input is turned on to it is turned off. Totalized value is recorded (and reset) when it is turned off.

(Totalize calculation is not reset even if the power is turned off.)

(d) To set digital input

- Use DI input for totalizing when “Counter” or “Timer” is specified for totalize calculation.

(e) To set totalize base time

- Totalize base time can be selected from /s, /min, /h, and /day.

Example: If the flow rate is 120L/min, totalized value for each totalize base time appears as follows.

Base time	/s	/min	/h	/day
Totalized value	2	120	7,200	172,800

* Flow rate of 120L/min is also expressed as 2L/s (120/60), or 7,200L/h (120×60).

(f) To set reset operation

- If “Reset Operation” setting is ON, totalize data is recorded in the totalize file at every totalize cycle.
- If “Reset Operation” setting is OFF, sum total data from the start of totalizing is recorded in the totalize file.

Example: If the flow rate is 100L/h, the record data appears as follows.

Elapsed time	Totalize reset	
	OFF	ON
1 hour	100	100
2 hours	200	100
3 hours	300	100

(g) To set totalize unit

Move the cursor to “Totalize unit” and press the **(ENT)** key to display the following unit select screen. Select the desired unit using the cursor key and then press the **(ENT)** key.

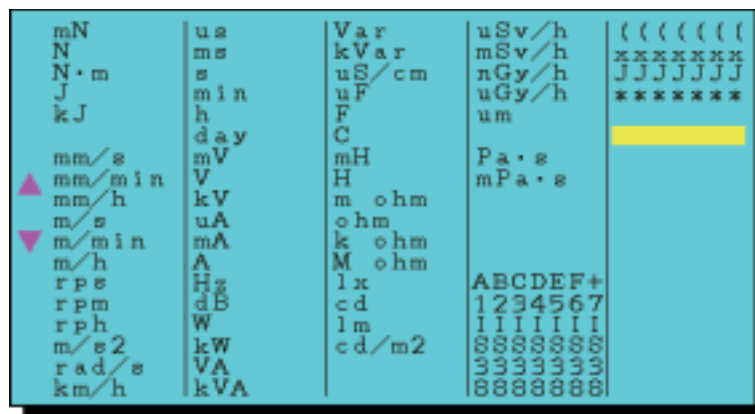
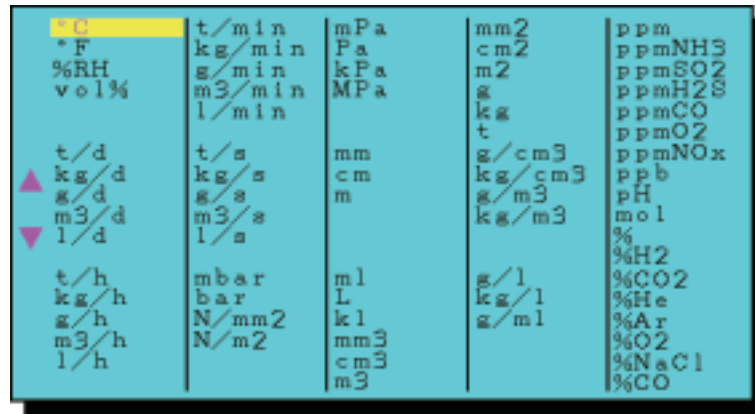

(h) To set totalize cut value

Move the cursor to “Totalize cut value” and press the **(ENT)** key to display the following totalize cut value setting screen. Enter totalizing cut value using the cursor and the **(ENT)** key.

- If the measured value is smaller than the totalizing cut value, the measured value is regarded as 0 in the totalizing (totalizing value does not increase).

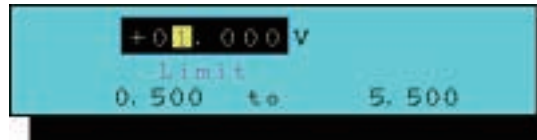

(i) To set totalize scale value

Move the cursor to “Totalize scale value” and press the **(ENT)** key, and the following totalize scaling setting screen appears.

Enter the scaling value using the cursor key and press the **(ENT)** key.

- Specify as “Totalize scale value” the scale conversion value used to convert the input value to totalized value. Division only is allowed. Multiplication cannot be performed.

Totalize value = Analog input/Totalize scale value

Example: To convert the unit of input value (L/h) to [m³/h],

$$1 \text{ [L/h]} = 1/1000 \text{ [m}^3\text{/h]}$$

$$\text{Totalize scale value} = 1000$$



(19) To set alarms

Move the cursor to “Alarm setting” and press the **ENT** key, then following alarm setting screen appears.

Select a desired item by using the cursor key, and then press the **ENT** key.

Alarms can be set up to 4 points per channel. (Alarm No. 1 to 4)

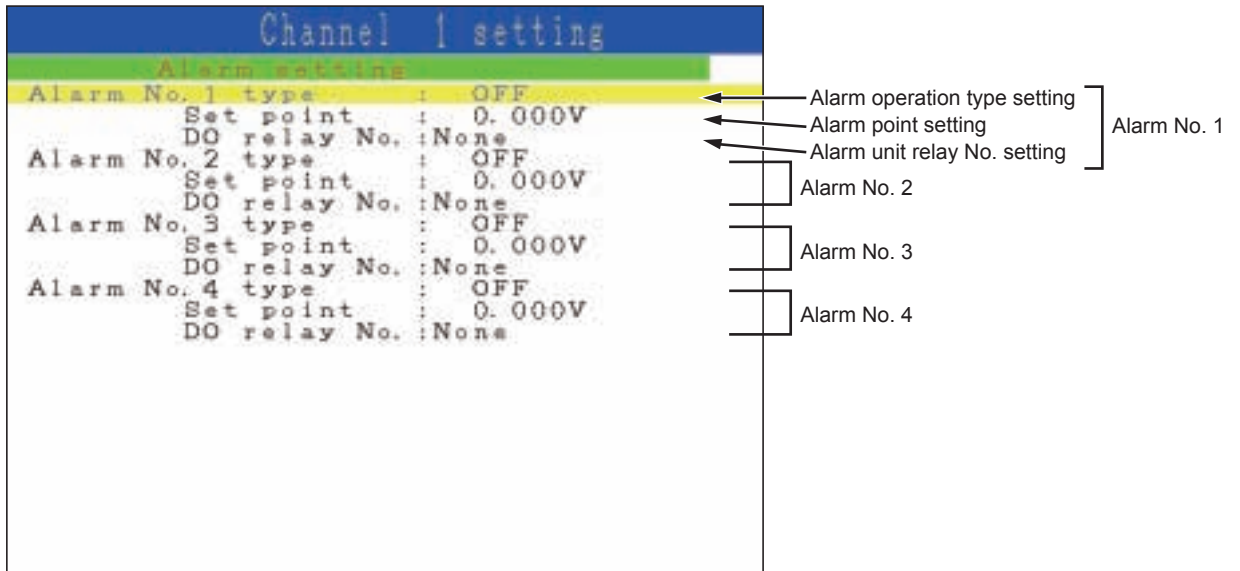

(a) To set the type of alarm operation

Select from alarm types H and L by using the cursor key.

- Two alarm levels, H and L (H or L can be arbitrarily selected for each alarm.)

Select OFF to stop the alarm operation.

(b) To set alarm DO relay No.

Select alarm DO relay No. by using the cursor key.

- Select optional alarm unit relay No. 1 to 36. If not necessary, select “None” for no output.

(c) To set alarm set point

Move the cursor to “Alarm set point” and press the **ENT** key, and the following alarm setting screen appears. Enter desired alarm set point using the cursor key and the **ENT** key.

- Make the setting using engineering values (absolute value alarm).



8.3 Copying parameters

[Explanation]

Parameters can be copied to other channels.

Parameters that can be copied are input type, input filter, scaling, recording range, unit, TAG No., alarm setting, and subtraction channel.

[Operation]

Select the “parameter setting” on the menu screen and enter the password if the configuration password has been set, then select “Channel setting copy”. After that, following “channel setting copy” screen appears.

Copy screen used when the number of input points is 36

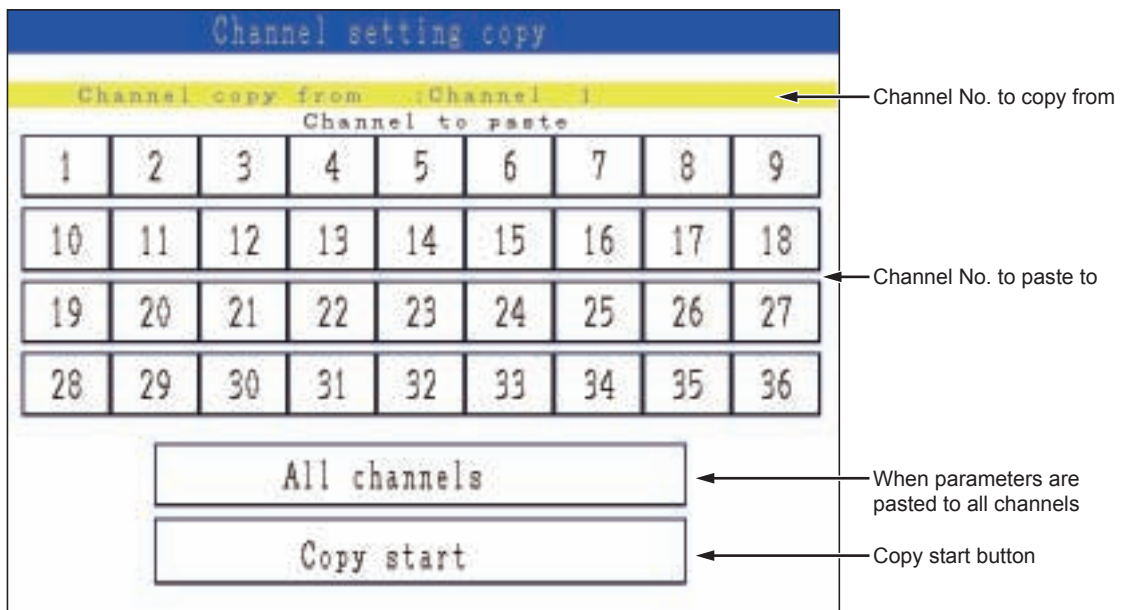

(1) Channel No. to copy from

Select a channel No. from which parameters are to be copied using the cursor key. Then press the **(ENT)** key, and following channel selection screen appears.



(2) Channel No. to paste to

Select the channel No. to which parameters are to be pasted using the cursor key and press the **(ENT)** key. If you want to cancel, press the **(SEL)** key.
(When you want to paste to all the channels, select “All channels.”)

(3) Copy start button

Move the cursor to “Copy start” by using the cursor key and press the **(ENT)** key, then the guidance screen as shown next page appears.

Press the **(ENT)** key to copy, and press the **(SEL)** key to cancel.

Guidance screen for the number of input points of 36

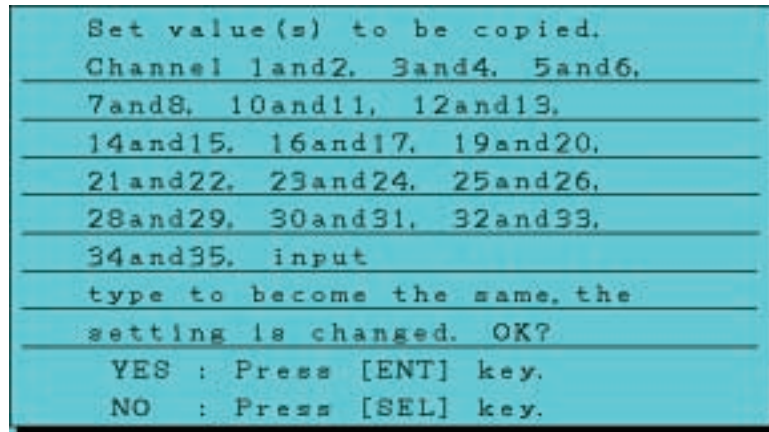

8.4 Setting calculation function

[Explanation]

36 channels from Channel 37 to 72 can be used as calculation channels.

- (a) Three operations \times 4 formulas can be set for each channel.

The result of Formula 4 is input to the operation channel.

The result of operation is limited to ± 32767 with all digits to the right of the decimal point discarded.

- (b) Note 1: Arithmetic operations are performed from left to right without fail.

Example: Formula 1, $B01 = C01 + C02 \times C03$, is calculated as $B01 = (C01 + C02) \times C03$.

Note 2: $AVG(A)$ and $SUM(A,B)$ can be used only once for each channel.

Note 3: It takes a long time to perform many arithmetic operations, and consequently the display cycle of measurement may become long.

Refer to the following table for the functions used for calculation.

Operation	Grammar	Description
Arithmetic operation (addition)	A+B	Adds the value of input A and input B.
Arithmetic operation (subtraction)	A-B	Subtracts the value of input B from input A.
Arithmetic operation (multiplication)	A*B	Multiplies the value of input A by input B.
Arithmetic operation (division)	A/B	Division the value of input A by input B. Note: The result of calculation of 0/0 is 0.
Absolute value	ABS(A)	Finds the absolute value of input A.
Power	POW(A,B)	Finds the value of input A to the power input B. ($A^{**}B$)
Square root	SQR(A)	Finds the square root of the value of input A.
LOG	LOG(A)	Finds the common logarithm of the value of input A.
LN	LN(A)	Finds the natural logarithm of the value of input A.
EXP	EXP(A)	Finds the exponentiation of the value of input A with base "e."
Humidity	RH(A,B)	Finds the relative humidity when input A represents dry-bulb temperature and input B represents wet-bulb temperature.
Maximum (between channels)	MAX(A,B)	Finds the maximum value from inputs A and B.
Minimum (between channels)	MIN(A,B)	Finds the minimum value from inputs A and B.
Maximum (time)	H-P(A)	Finds the maximum value of input A. Initializes the maximum value by timer input.
Minimum (time)	L-P(A)	Finds the minimum value of input A. Initializes the minimum value by timer input.
Average	AVG(A)	Finds the average value of input A. Refreshes the average value by timer input.
Summatio	SUM(A,B)	Finds the sum of input A/B. Resets the sum by timer input
Clear the formula	END/Delete	Clear the formula without confirming. Be careful not to missoperate. You can't cancel this operation.
Set the soarce	Math data	Set the soorce from "Input channel", "Totalizer input", "Digital input", "Communication input", "Constant" or "Temporary formula".

(c) The input point that can be used for calculation are as follows.

Input	Grammar	Description
Input channel	C01 to C72	Channel 1 to 72 input
Totalize input	T01 to T72	Channel 1 to 72 totalize (The totalized value limited to 32767 with all digits to the right of the decimal point discarded is used.)
Digital input	D01 to D16	DI1 to 16 (OFF: 0, ON: 1)
Communicationn input	M01 to M36	1 to 36 (No decimal fraction allowed.)
Constant	K01 to K60	1 to 60
Temporary formula	B01 to B03	1 to 3

Detailed description of functions

ABS(A) : Finds the absolute value of input A

Example of output of ABS(A) is shown below. (The decimal place of operation channel is 1.)

Input A	Output ABS (A)	Memo
10.0	10.0	
-10.0	10.0	

POW(A,B) : Finds the value of input A to the power input B. (AB)**

If negative fractional value is raised to the power of a fractional value, 0 is output.

The result of 0 raised to the power of 0 is 1.00

Example of output of POW(A) is shown below. (The decimal place of operation channel is 1.)

Input A	Input B	Output POW (A, B)	Memo
50.0	2.0	2500.0	
-5.5	2.5	0.0	When erroneous data is input.
0.0	0.0	1.0	The result of 0 raised to the 0th power is 1.

SQR(A) : Finds the square root of the value of input A.

If negative data is input, 0 is output.

Example of output of SQR(A) is shown below. (The decimal place of operation channel is 1.)

Input A	Output SQR (A)	Memo
100.0	10.0	
-10.0	0.0	If negative data is input, 0 is output.

LOG(A) : Finds the common logarithm of the value of input A.

If negative data is input, 0 is output.

Example of output of LOG(A) is shown below. (The decimal place of operation channel is 1.)

Input A	Output LOG (A)	Memo
100.0	2.0	
-10.0	0.0	If negative data is input, 0 is output.

LN(A) : Finds the natural logarithm of the value of input A.

If negative data is input, 0 is output.

Example of output of LN(A) is shown below. (The decimal place of operation channel is 1.)

Input A	Output LN (A)	Memo
100.0	4.6	
-10.0	0.0	If negative data is input, 0 is output.

EXP(A) : Finds the exponentiation of the value of input A with base “e”. (eA)**

Example of output of EXP(A) is shown below. (The decimal place of operation channel is 1.)

Input A	Output EXP (A)	Memo
1.2	3.3	

RH(A,B) : Finds the relative humidity when input A represents dry-bulb temperature and input B represents wet-bulb temperature.

The temperature range that allows the calculation of humidity is from -40 to +150°C.

If the wet-bulb temperature is equal to or higher than the dry-bulb temperature, 100%RH is output.

If the temperature is outside the measurable range, the values in the following table are output.

		Wet-bulb temperature		
		Lower than -40°C	Within the range	Higher than +150°C
Dry-bulb temperature	Lower than -40°C	0%RH	0%RH	0%RH
	Within the range	0%RH	Calculated value	100%RH
	Higher than +150°C	0%RH	100%RH	100%RH

Example of output of RH(A,B) is shown below. (The decimal place of operation channel is 1.)

Input A (Dry-bulb temperature)	Input B (Wet-bulb temperature)	Output RH (A, B)	Memo
70.0	65.0	79.2	
70.5	70.0	100.0	100%RH is output if input A = Input B.
50.0	-41.0	0.0	Input B < -40°C
151.0	10.0	100.0	Input A > 150°C

MAX(A,B) : Finds the maximum value from inputs A and B.

Example of output of MAX(A,B) is shown below. (The decimal place of operation channel is 1.)

Input A	Input B	Output MAX (A, B)	Memo
50.0	49.0	50.0	Input A > Input B
49.0	50.0	50.0	Input A < Input B

MIN(A,B) : Finds the minimum value from inputs A and B.

Example of output of MIN(A,B) is shown below. (The decimal place of operation channel is 1.)

Input A	Input B	Output MIN (A, B)	Memo
50.0	49.0	49.0	Input A > Input B
49.0	50.0	49.0	Input A < Input B

H-P(A) : Finds the maximum value of input A.

The output is initialized in a cycle established as H-P, L-P timer cycle.

Example of output of H-P(A) is shown below. (The decimal place of operation channel is 1, and H-P, L-P timer cycle is 2 minutes.)

Input A	Output H-P(A) (Output value per cycle)	Memo
Sine wave cycle: 1 minute, Amplitude: 50.0, Bias: 0.0	50.0	Maximum sine wave value

L-P(A) : Finds the minimum value of input A.

The output is initialized in a cycle established as H-P, L-P timer cycle.

Example of output of L-P(A) is shown below. (The decimal place of operation channel is 1, and H-P, L-P timer cycle is 2 minutes.)

Input A	Output L-P(A) (Output value per cycle)	Memo
Sine wave cycle: 1 minute, Amplitude: 50.0, Bias: 0.0	-50.0	Minimum sine wave value

AVG(A) : Finds the average value of input A.

**The average value during the cycle established as AVG timer cycle is output.
(Display is not changed during the cycle.)**

Example of output of AVG(A) is shown below. (The decimal place of operation channel is 1, and the AVG timer cycle is 2 minutes.)

Input A	Output AVG(A) (Output value per cycle)	Memo
Sine wave cycle: 1 minute, Amplitude: 50.0, Bias: 0.0	0.0	Average sine wave value

SUM(A) : Finds the sum of input A/B.

**The totalized value is reset in the cycle established as the SUM timer cycle.
Negative values can also be totalized.**

Example of output of SUM(A) is shown below. (The decimal place of operation channel is 1, and the SUM timer cycle is 2 minutes.)

Input A (Fixed)	Input B (Fixed)	Output SUM (A, B)	Memo
50.0	120.0	50.0	
50.0	60.0	100.0	
-50.0	120.0	-50.0	

[Operation]

Select the “parameter setting” on the menu screen and enter the password if the configuration password has been set, then select “Math channel setting” and desired channel number. After that, following channel number setting screen appears. Press the **(ENT)** key.

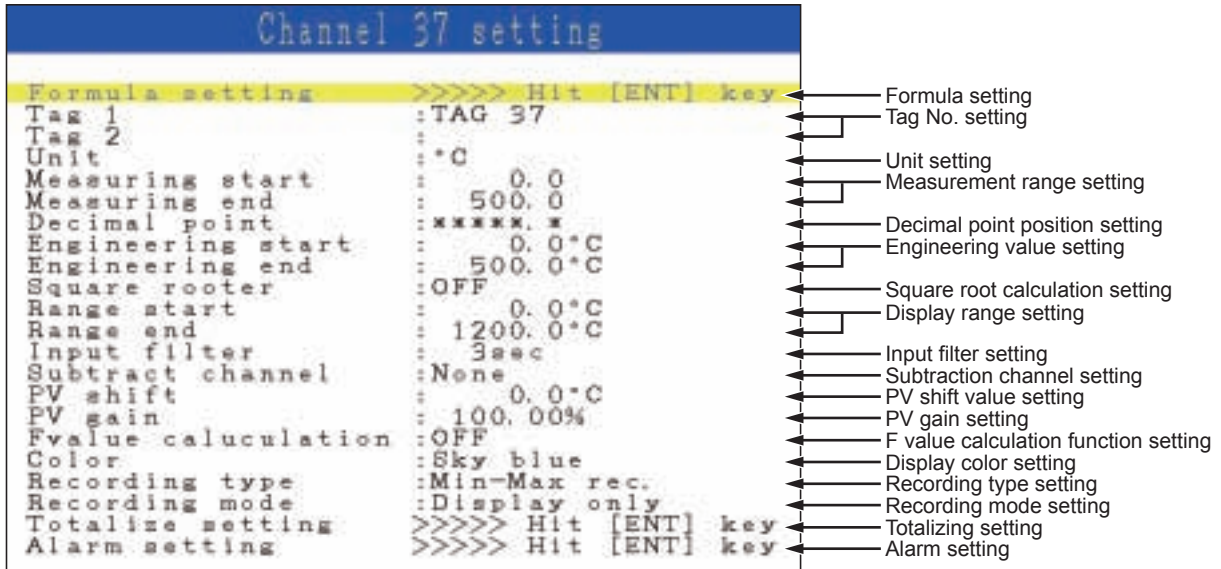

(1) Formula setting

Move the cursor to “Formula setting” and press the **(ENT)** key, and the following formula setting screen appears.

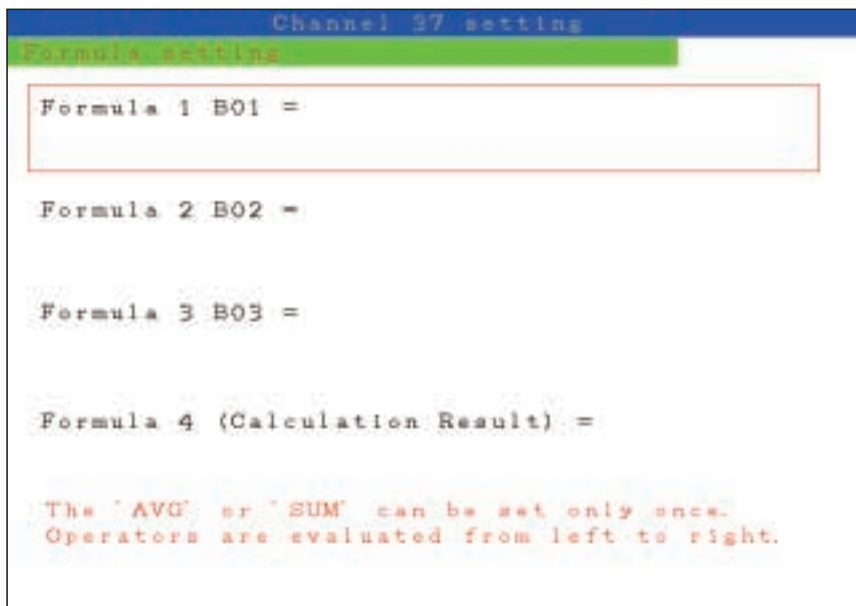

Move the cursor to the formula you want to make the setting and press the **(ENT)** key, and the following formula setting screen appears.

Note: The result of Formula 4 is output to the operation channel.



Press the **(ENT)** key once again, and the following function selection screen appears.

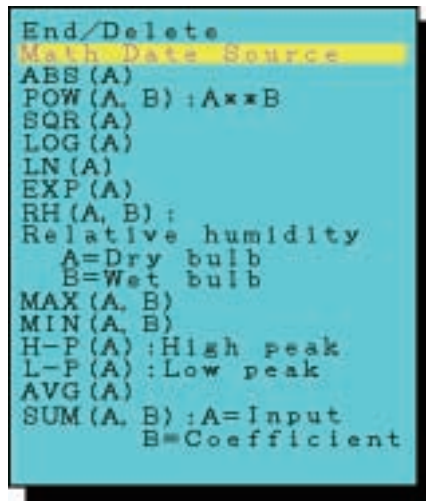

Move the cursor to the function you want to use and press the **(ENT)** key, and the following input data type selection screen appears.

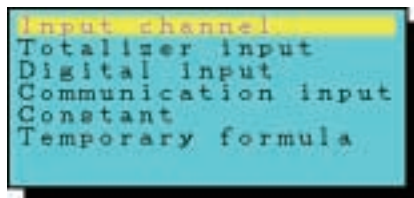

Move the cursor to the input type you want to use and press the **(ENT)** key. On the input type selection screen that appears, select an input type you want to use.

Press the **(ENT)** key, and the formula setting screen appears again.

To set the next operation, move the cursor to the right using the > key, and make the setting in the same manner.

To delete a formula, select "End/Delete."

(2) TAG. No. setting and subsequent settings

For the setting procedures from Tag No. to alarm setting, refer to Item 8.2 (2).

8.5 Setting timer for calculation

[Explanation]

Only when the use of timer is specified when formula is selected in Item 8.4 “Calculation function,” follow procedure shown below.

[Operation]

Select the “parameter setting” on the menu screen and enter the password if the configuration password has been set, then select “Math timer setting”.

After that, following “Math timer setting” screen appears.

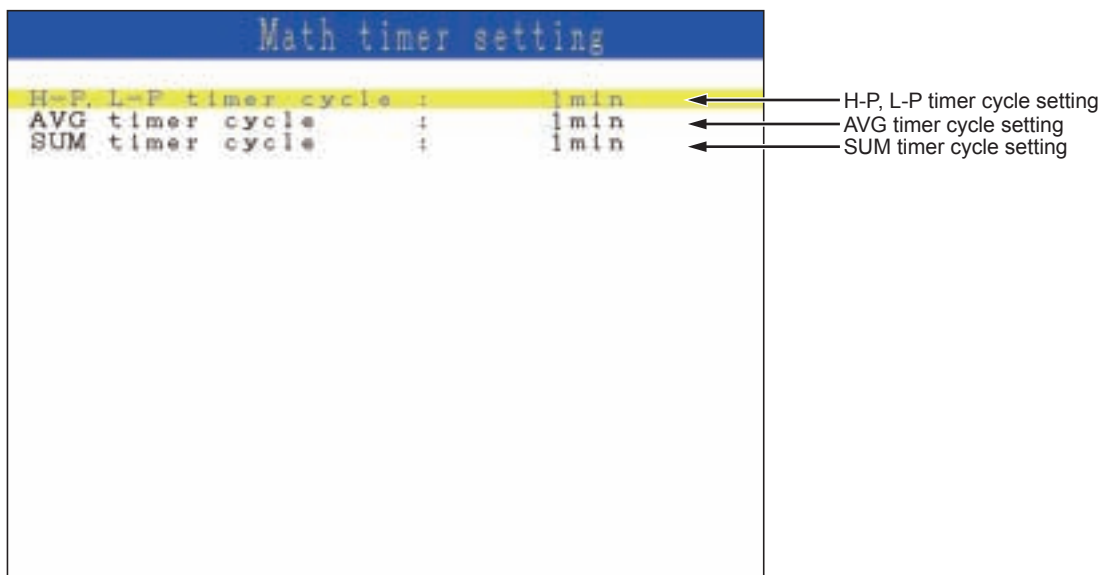

(1) H-P, L-P timer cycle setting

Move the cursor to “H-P, L-P timer cycle” and press the **ENT** key, then the following operation cycle setting screen appears.

Enter cycle time using the cursor key and press the **ENT** key.

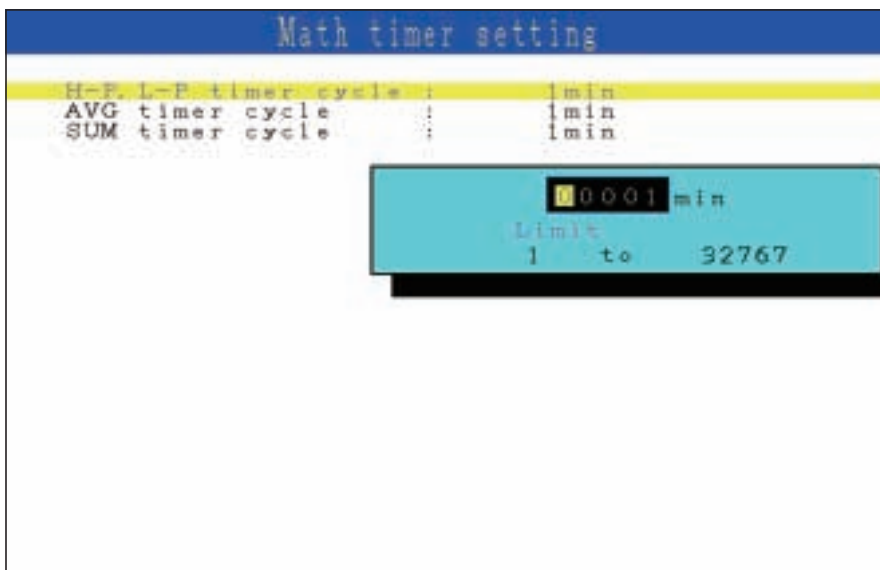

(2) AVG timer cycle setting

Move the cursor to “AVG timer cycle” and press the (ENT) key, then the following operation cycle setting screen appears.

Enter cycle time using the cursor key and press the (ENT) key.

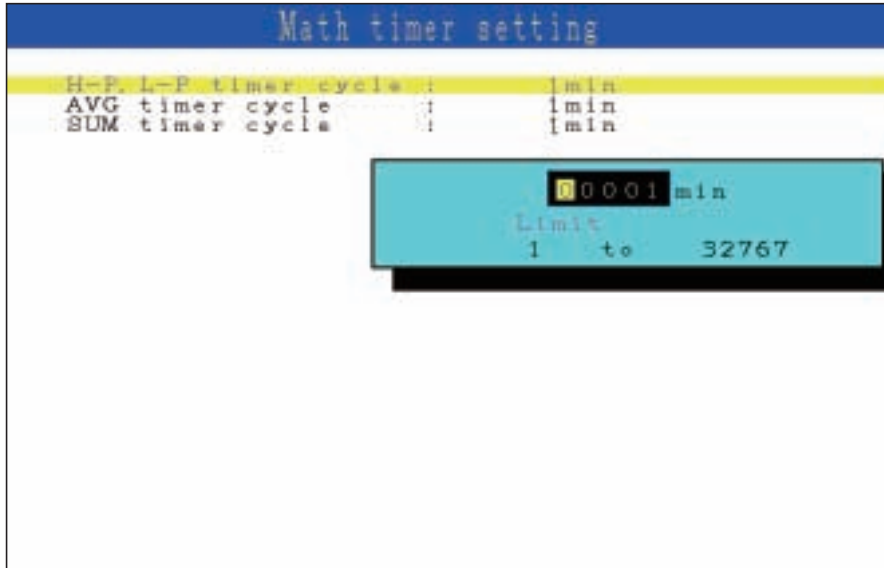

(3) SUM timer cycle setting

Move the cursor to “SUM timer cycle” and press the (ENT) key, then the following operation cycle setting screen appears.

Enter cycle time using the cursor key and press the (ENT) key.

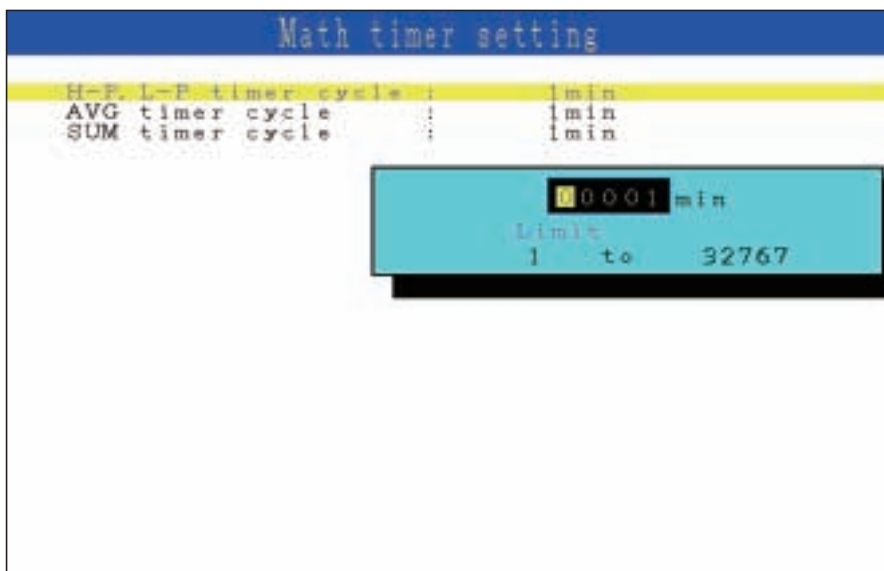

8.6 Setting for data display screen

Four combinations of the input channels you want to display (called screen structure or group screen) can be set on the data display screen.

[Explanation]

- Set the name of group screen using alphanumerical characters. Up to 16 characters can be entered.
- Set the screen structure (group screen) on the data display screen.

[Operation]

Select the “parameter setting” on the menu screen and enter the password if the configuration password has been set, then select “Display setting” and desired display group number.

After that, following display group setting screen appears.

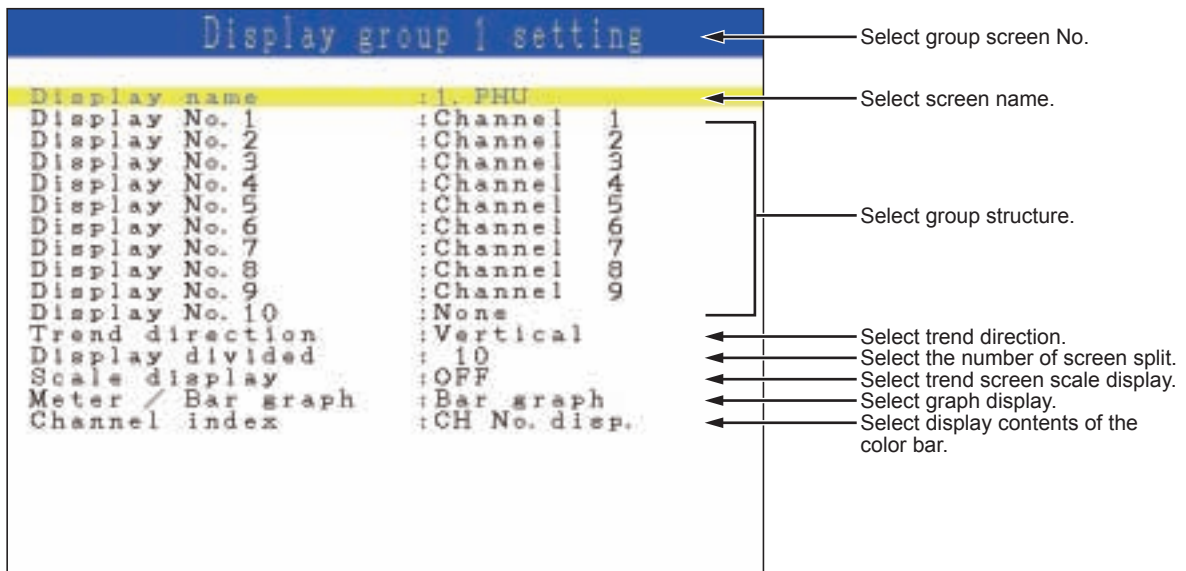

- Set the group construction.
- Select the direction (vertical or horizontal) of the trend screen (real time trend screen and historical trend screen).
- Select the number of screen division.
- Select ON/OFF of the trend screen scale display.
- Select bar graph or analog meter as a measurement display method.
- Select one from Tag No. display, unit display or channel No. display as display contents of the color bar.
- If a group has less than 4 channels, the real time trend display, etc. automatically switch to the screen for 4-channel display.

(1) To set display name

Move the cursor to “Display name” and press the **(ENT)** key, then the following character entering screen appears. Enter the display name using the cursor and press the **(ENT)** key.

When the name is entered, press the **(SEL)** key to register the screen name.

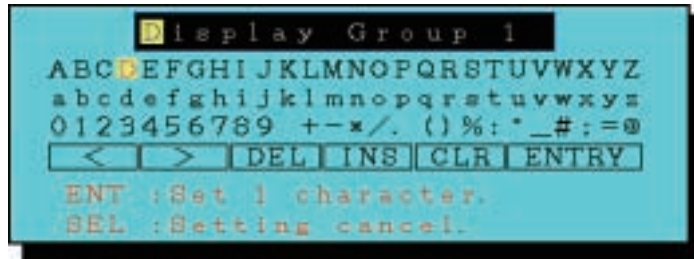

(2) To set display structure

Move the cursor to the channel No. you want to make setting change on the display group setting screen and press the **(ENT)** key, then the following channel setting screen appears.

Note: The following figure is a channel setting screen for the number of inputs of 9.



channel setting screen

Select channel No. using the cursor and press the **(ENT)** key.

Selecting “None” does not make recording at that position on the data display screen.

The following is the relation between the No. of the display structure and the data display screen.

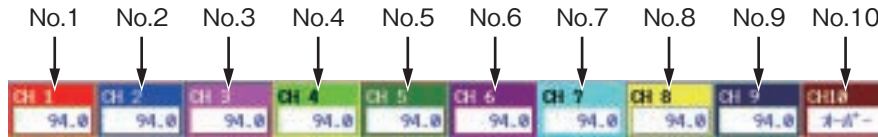

(3) To set trend direction

Move the cursor to “Trend direction” and press the **(ENT)** key, then the setting screen appears.

Select trend display direction using the cursor key and press the **(ENT)** key.



(4) To set the number of display division

Move the cursor to “Display divided” and press the **(ENT)** key, then the number of display division setting screen (1 to 20) appears. Select the number of division using the cursor key and press the **(ENT)** key.

Note) Display division is not allowed if scale display has been selected.

(5) To set trend screen scale display

Move the cursor to “Scale display” and select “OFF” or “ON” using the cursor key. Then press the **(ENT)** key.

The scale of the displayed channel can be arbitrarily changed using the **(ENT)** key.

Note: If the input type is changed in the state where a chart is remaining on the trend screen, proper display cannot be obtained.



(6) To set graph display

Move the cursor to “Analog meter” and press the **ENT** key, then the setting screen appears. Select a bar graph display using the cursor key and press the **ENT** key.

* The analog meter displays only the channels from No. 1 to No. 4 in the screen structure.

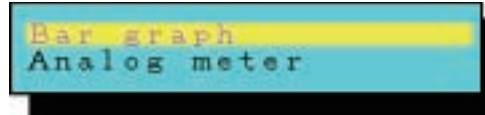

(7) To select channel index

Move the cursor to “Channel index” and press the **ENT** key, then the setting screen appears.

Select one from “Channel No. display,” “Tag No. display” and “Unit display” using the cursor key and press the **ENT** key.

In case of 4 or 6 channel trend display screen, all contents (“Channel No. display”, “TAG No. display” and “Unit display”) are displayed.

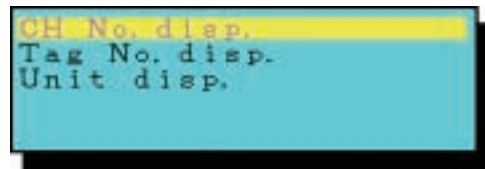

8.7 Setting for F value calculation (Setting common to all channels)

[Explanation]

- Select the calculation constants to be used for F value calculation (Extinction value calculation of bacteria by sterilization by heating) that are common to all channels.

F value calculation constants: Reference temperature, Z value, Decimal point position

- By selecting a reset temperature, the F value can be reset.
- F value calculation can be manually reset.

Note: Make sure that the number of decimal places of the channel with which F value calculation is to be performed is one.

[Operation]

Select the “parameter setting” on the menu screen and enter the password if the configuration password has been set, then select “F value calculation setting”.

After that, following “F value calculation setting” screen appears.

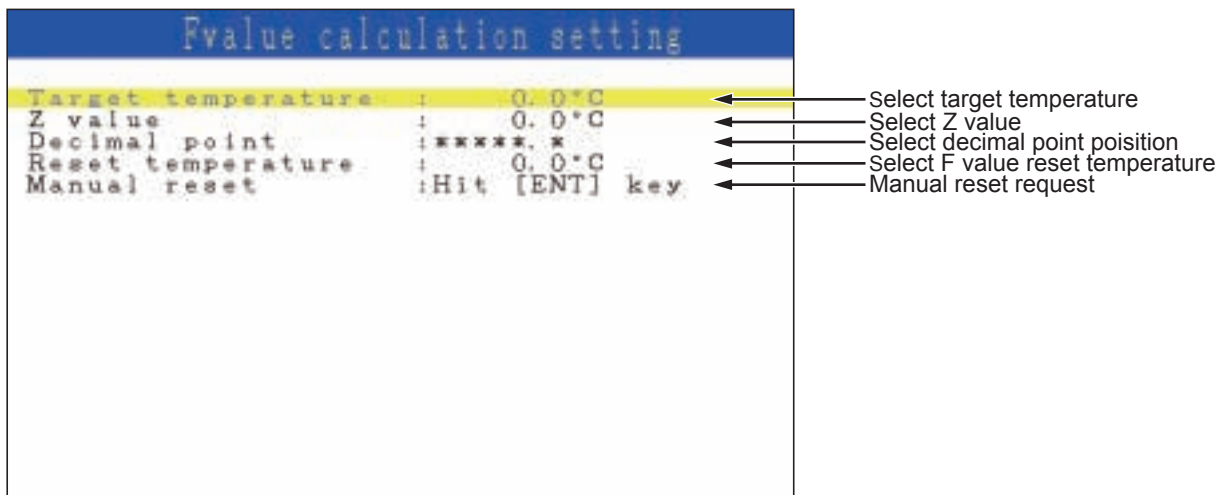

(1) To set target temperature

Move the cursor to “Target temperature” and press the **(ENT)** key, then the following target temperature setting screen appears. Enter the target temperature using the cursor and press the **(ENT)** key.

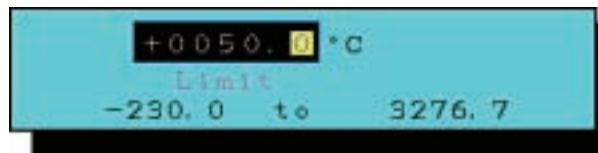

(2) To set Z value

Move the cursor to “Z value” and press the **(ENT)** key, then the following Z value setting screen appears. Enter Z value using the cursor and press the **(ENT)** key.

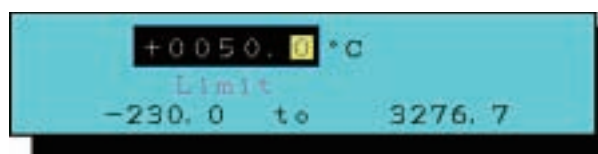

(3) To set decimal point position

Move the cursor to “Decimal point” and press the **ENT** key, then the decimal point position setting screen appears. Select the decimal point position of F value calculation result using the cursor key and press the **ENT** key.



(4) To set F value reset temperature

Set F value reset temperature. If PV is less than this temperature, PHL make F value to zero. Move the cursor to “Reset temperature” and press the **ENT** key, then the following F value reset temperature screen appears.

Enter the reset temperature using the cursor key and press the **ENT** key.

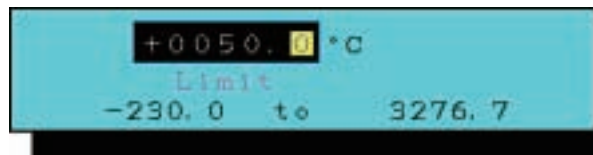

(5) Manual reset request

To reset manually the F value, move the cursor to “Manual reset” and press the **ENT** key.

8.8 Setting totalizing (Setting common to all channels)

[Explanation]

It is the common setting for all totalize type.

Each settings are effective to totalize type as shown below table.

Settings	Periodic	Daily	Weekly	Monthly	Annualy	Daily(Time)	Externaly
Totalize base time	○	○	○	○	○	—	—
Totalize cycle	○	—	—	—	—	—	—
Weekly base day	—	—	○	—	—	—	—
Monthly base day	—	—	—	○	—	—	—
Totalize start/stop time	—	—	—	—	—	○	—
External input	—	—	—	—	—	—	○
○: effective			— : non-effective				

[Operation]

Select the “parameter setting” on the menu screen and enter the password if the configuration password has been set, then select “Totalize setting”.

After that, following “Totalize setting” screen appears.

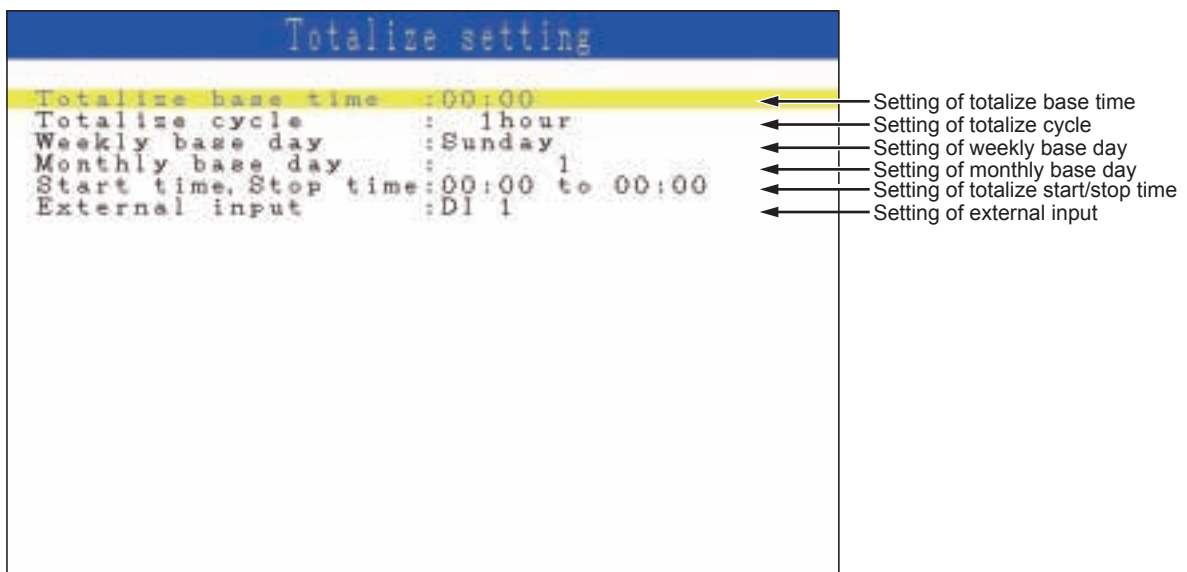

(1) To set totalize base time

Set the totalize base time, date, day, cycle and so on.

In case of totalize type is “Dairy”, PHU records at the setting of “Totalize base time” every day.

In case of totalize type is “Weekly”, PHU records at the setting of “Totalize base time” on “Weekly base day”.

In case of totalize type is “Monthly”, PHU records at the setting of “Totalize base time” on “Monthly base day”.

In case of totalize type is “Annual”, PHU records at the setting of “Totalize base time” on January 1st.

In case of totalize type is “Periodic”, PHU records every “Totalize cycle” based on “Totalize base time”. See following example.



[Example]

< settings >

Totalize base time 10:17
Totalize cycle 20min

<Working>

Recording start time : At 09:22
First recording : At 09:37 ← 10:17 + 23:20
Second recording : At 09:57 ← 10:17 + 23:40
Third recording : At 10:17 ← 10:17 + 24:00 = 10:17
Fourth recording : At 10:37 ← 10:17 + 00:20

Therefore, recording timing is at:

[Totalize base time + Totalize cycle]

(2) To set totalize cycle

Set the totalizing cycle for totalize type, "Periodic".

The setting is selected from 10, 20, 30 minutes, 1, 2, 3, 4, 6, 12 or 24 hours.

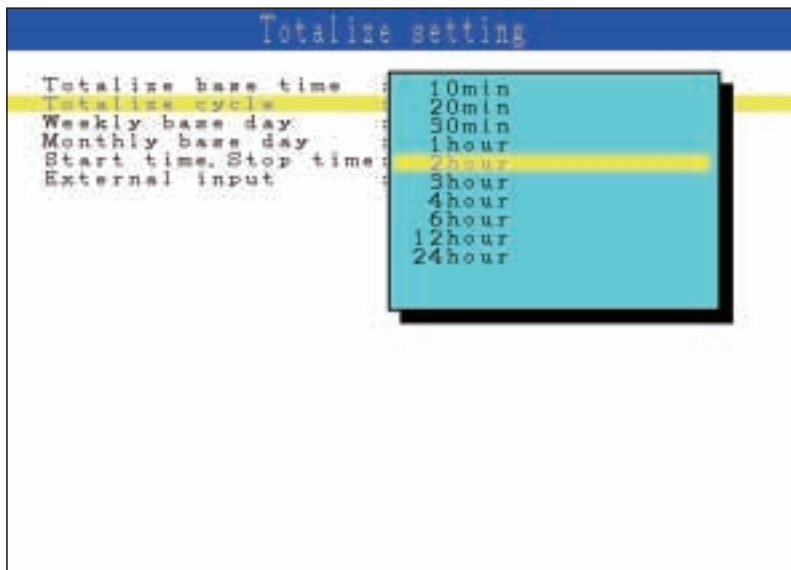

(3) To set weekly base day

Set the data recording date for totalize type, "Weekly".

The setting is selected from Sunday, Monday, Tuesday, Wednesday, Thursday, Friday or Saturday.

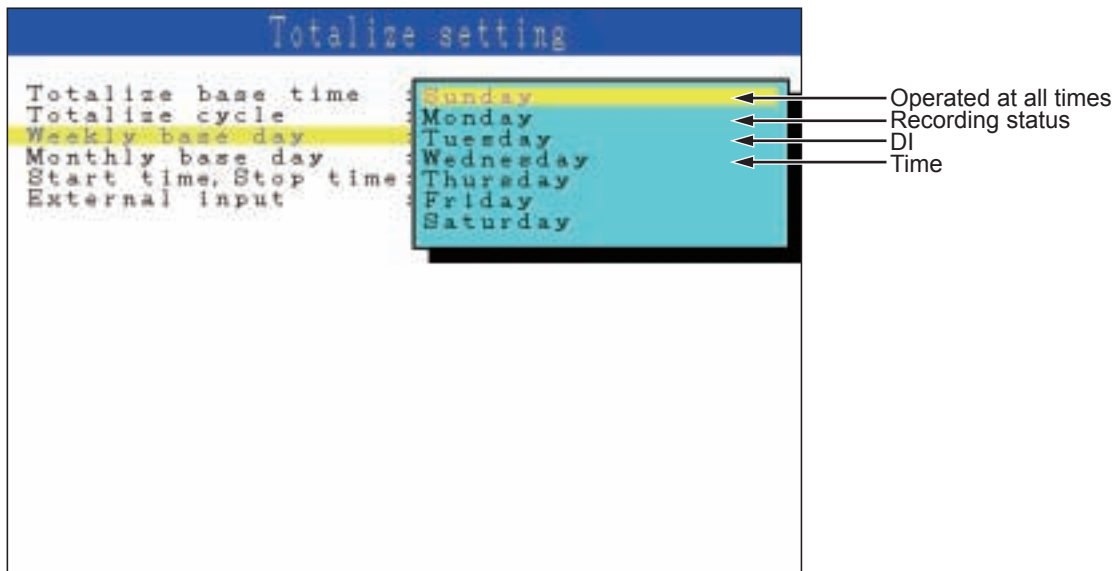

(4) To set monthly base day

Set the data recording day for totalize type, “Monthly”.

Setting range is through 1 to 31.

For example, when you set “31” to this parameter and this month is April,

PHL records totalizing data on the last day of the month. This case, it is on April 30th.

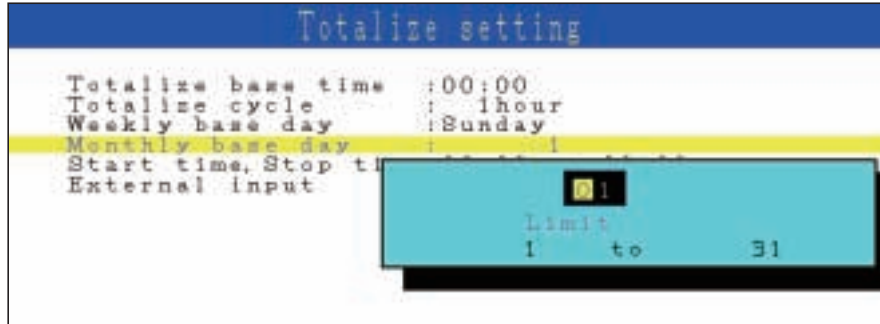

(5) To set totalize start time, stop time

Set the totalizing start time and stop time for totalize type, “Dairy (at designated time)”.

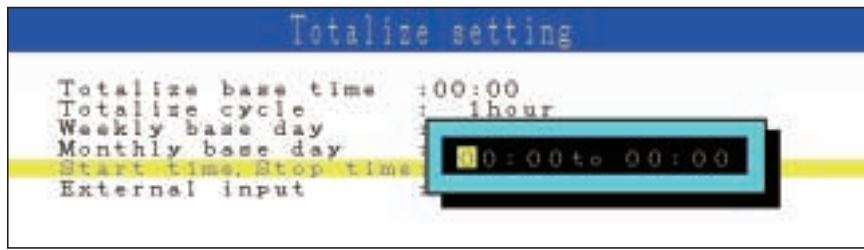

(6) To set external input

Set which external input PHL use as trigger to start/stop totalizing for totalize type, “External input”.

DI or alarm status of all channel is available as external input.

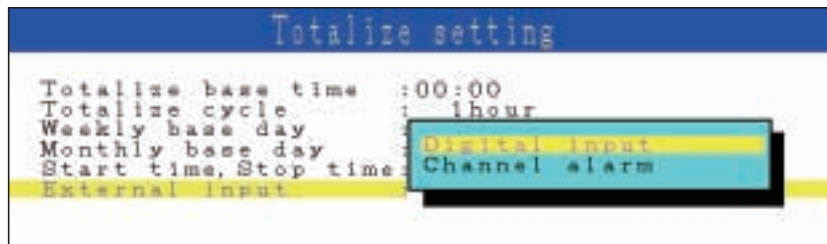

8.9 Setting for messages

[Explanation]

- When various events occur, messages can be displayed.
- Up to 10 messages of 32 characters each can be registered.
- The message can be set with alphanumeric characters.
- Message timing to be displayed can be set at “ON/OFF of Alarm”, and ON/OFF of DI input.
- Message data can be recorded only in an event file of the memory card.

[Operation]

Select the "parameter setting" on the menu screen and enter the password if the configuration password has been set, then select "Message setting" and desired message number.

After that, following message setting screen appears.

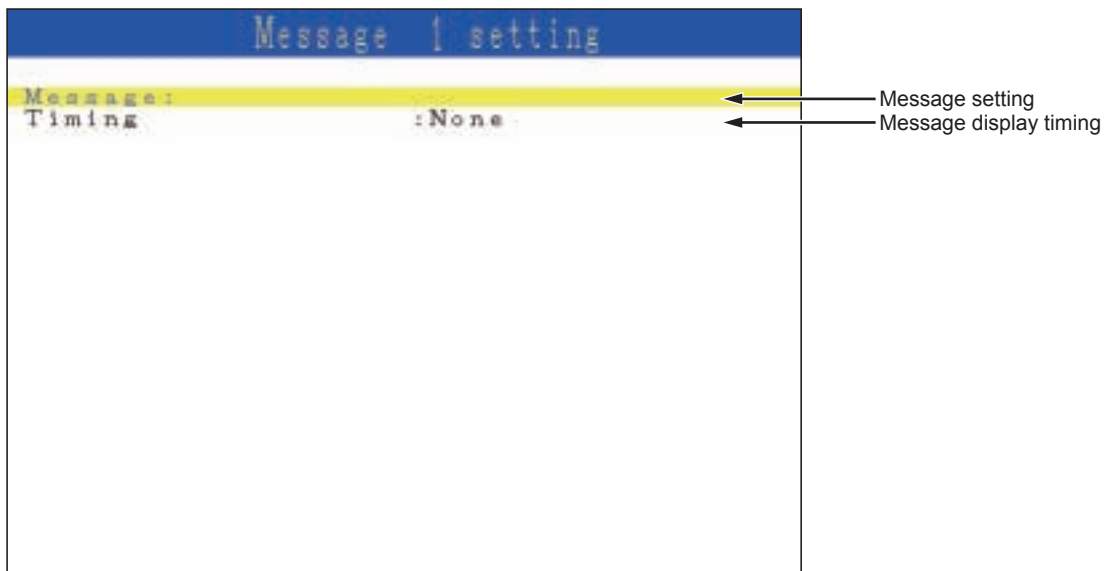

(1) To set messages

Move the cursor to “Message” and press the **ENT** key, then message screen appears as shown below. Enter message by the cursor and press the **ENT** key for confirmation.

After entry of the message, press the **SEL** key to return to message setting screen.

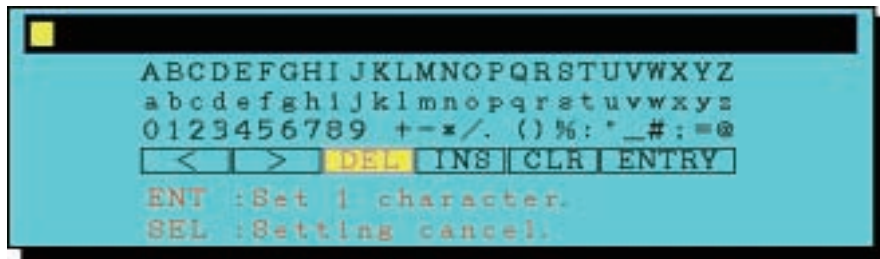

(2) To set the message display timing

Move the cursor to “Timing” and press the (ENT) key, then message timing selection screen appears as shown below. Select message timing by the cursor and press the (ENT) key.



(3) To set the alarm No. and channel No. for the message.

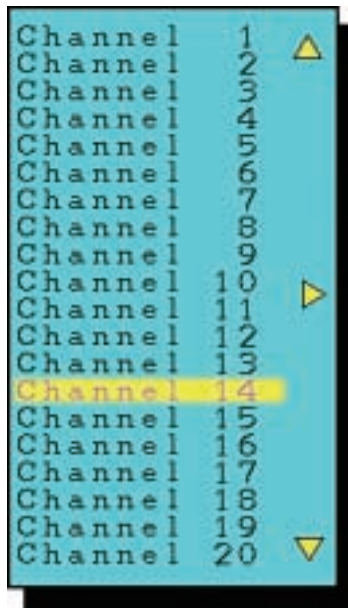

Channel selecting screen



Alarm number selecting screen



DI number selecting screen

8.10 Unit definition

[Explanation]

The Original unit definition screen allows you to make units with up to 7 alphanumeric characters. Up to 12 types of units can be registered. The unit can be verified by the unit selection given in Item 8.2.

[Operation]

Select the “parameter setting” on the menu screen and enter the password if the configuration password has been set, then select “Original unit definition”.

Then following “Original unit definition” screen appears.

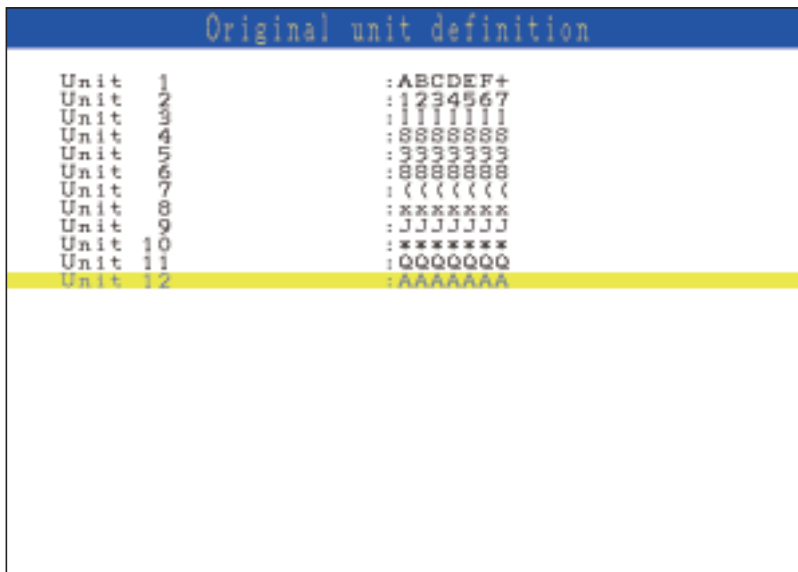

Move the cursor to the unit box that remains blank by the cursor key. Press the **ENT** key, and the following unit naming screen appears.

Enter a unit by the cursor key and then press the **ENT** key for confirmation.

After entry of the unit, press the **SEL** key to return to the “original unie definition” screen.

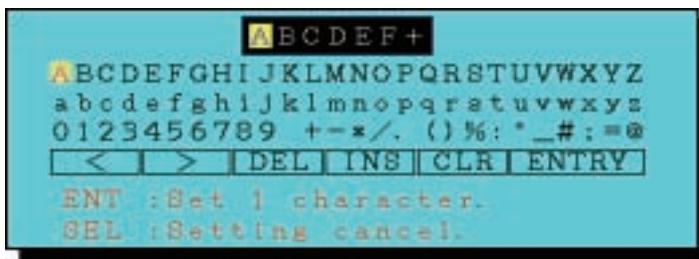

8.11 Setting for DI (external control unit) function

[Explanation]

Note: Up to 10 DIs are provided, which allows the following operations to be performed.

(1) Start/stop of record

Using DI, start/stop of the record can be switched.

- The record can also be started/stopped from the keypad on the front face.
- Start/stop switching function of the record is judged according to rise/fall edge of DI.
OFF → ON (Rise): Recording start (No change if the recording is made from the start.)
ON → OFF (Fall): Recording stop (No change if the recording is stopped from the start.)

(2) F value calculation reset

F value calculation can be reset using DI.

- F value calculation reset is judged based on Rise/Fall edge of DI.
OFF → ON (Rise): F value calculation is reset.
ON → OFF (Fall): No change

(3) Start/Stop of totalizing

Totalizing can be started/stopped using DI.

- OFF → ON (Rise): Starts totalizing.
- ON → OFF (Fall): Stops totalizing.

(4) Totalize reset

Totalize can be reset using DI.

- Totalize reset is judged based on Rise/Fall edge of DI.
OFF → ON (Rise): Totalizing data is reset.
ON → OFF (Fall): No change

(5) LCD ON

LCD can be turned on by DI.

It works as shown below.

Status	DI	
	OFF → ON	ON → OFF
LCD off	LCD turns on	No change
LED ON	No change	No change

(6) Message set

Message can be set using DI.

- In distinction from the function described in (1) to (5) above, message set can be set on the message setting screen.
- Message set function also works if the functions described in (1) to (5) shown above are allocated to DI. (Both the function allocated to DI and the message set function are operated.)

(7) E-mail trigger set

E-mail trigger can be set using DI.

- In distinction from the functions described in (1) to (5) above, E-mail trigger can be set on the E-mail trigger set screen.
- The E-mail trigger function also works even when the functions described in (1) to (5) shown above are allocated to DI.

(Both of functions allocated to DI and the E-mail trigger set function work.)

[Operation]

Select “Parameter setting” on the Menu screen and then “DI function setting” to display the DI function setting screen.

DI No.	DI function
DI 1	function : LCD ON
DI 2	function : Function invalid
DI 3	function : Function invalid
DI 4	function : Function invalid
DI 5	function : Function invalid
DI 6	function : Function invalid
DI 7	function : Function invalid
DI 8	function : Function invalid
DI 9	function : Function invalid
DI 10	function : Function invalid
DI 11	function : Function invalid
DI 12	function : Function invalid
DI 13	function : Function invalid
DI 14	function : Function invalid
DI 15	function : Function invalid
DI 16	function : Function invalid

Move the cursor to the DI No. with which DI function is to be selected and press the **ENT** key.

By using the cursor key, select either one of “Function invalid,” “Record start/stop,” “F value calculation reset,” “Totalize start/stop,” “Totalize reset” or “LCD ON”.

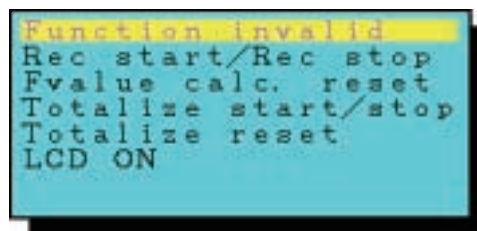

8.12 Setting constant

[Explanation]

Constants can be set to calculation function.

- The number of setting items can be set from 1 to 20.

[Operation]

Select the “parameter setting” on the menu screen and enter the password if the configuration password has been set, then select “Constant setting”.

Then following “Constant setting” screen appears.

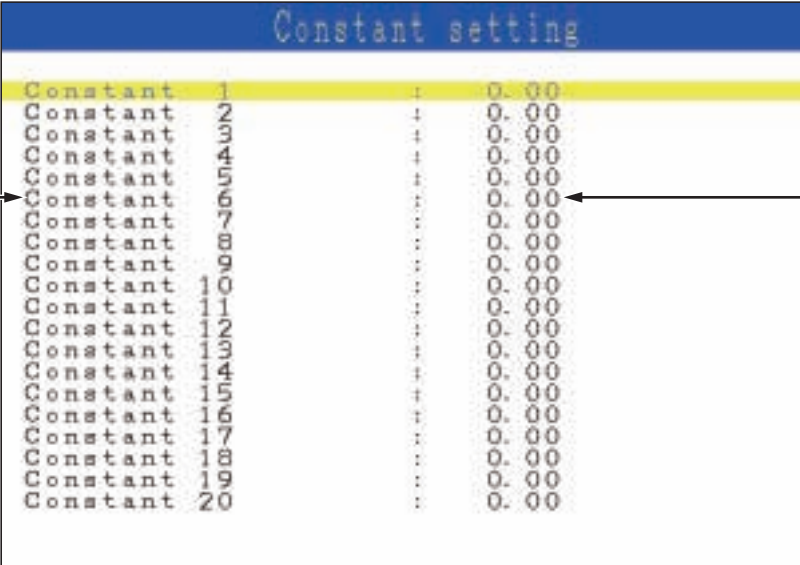

Constant setting			
Constant	1	:	0.00
Constant	2	:	0.00
Constant	3	:	0.00
Constant	4	:	0.00
Constant	5	:	0.00
Constant	6	:	0.00
Constant	7	:	0.00
Constant	8	:	0.00
Constant	9	:	0.00
Constant	10	:	0.00
Constant	11	:	0.00
Constant	12	:	0.00
Constant	13	:	0.00
Constant	14	:	0.00
Constant	15	:	0.00
Constant	16	:	0.00
Constant	17	:	0.00
Constant	18	:	0.00
Constant	19	:	0.00
Constant	20	:	0.00

Move the cursor to a desired setting item, and press the **(ENT)** key.

Enter the set value using the cursor key and press the **(ENT)** key.

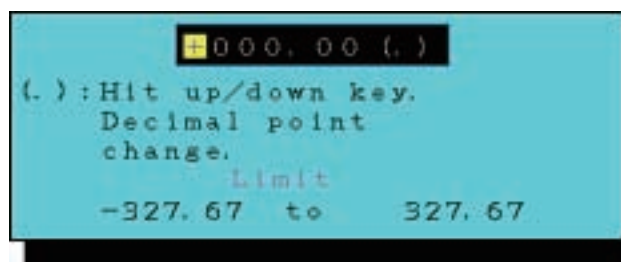

8.13 Ethernet function setting

[Description]

Make the setting as follows to use Ethernet function.

IP address, subnet mask, and default gateway can be set to connect the recorder main unit to Ethernet.

[Note]

- Connect the recorder to Ethernet to use the FTP, Web, E-mail, and MODBUS TCP/IP functions. Refer to the communication manual for details of connection.
- Contact the system administrator when connecting the recorder to the LAN.
- After making the setting of this parameter, store the setting (see Item 7.1), turn off the power, and turn it on again.

[Operation]

Move the cursor to “Ethernet setting” on the Parameter setting screen and then press the **ENT** key, and the Ethernet setting screen appears. Make the settings required to connect the recorder to Ethernet (Ethernet function, IP address, Subnet mask, Default, and gateway) and the settings of the functions to be used (FTP, Web, E-mail, and MODBUS). To use the E-mail function, E-mail setting (1) and E-mail trigger setting (2) must be made.

To use MODBUS TCP/IP function, Communication setting (3) is required. Refer to the communication manual for details.

CAUTION

- The communication automatically disconnects, if no FTP communication request is made for 10 minutes.
- The display motion of the paperless recorder may slow down when taking out a file of large size.
- While the compact flash of the paperless recorder is accessed by FTP communication, do not take out the compact flash. Furthermore, when the FTP server function is used, inhibit access to the compact flash in the “Memory card abstract” screen, before taking out the compact flash.
- Do not delete or change the name of a file while the file is being recorded or totalized.

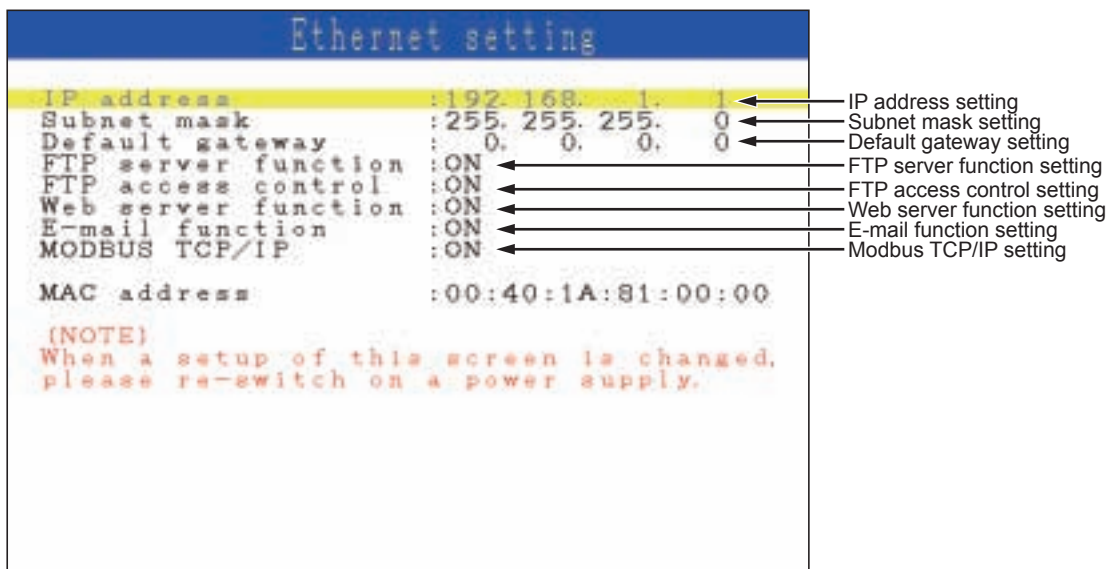

(1) E-mail setting

Check that E-mail function of Ethernet setting is set to ON before carrying out the E-mail setting. If E-mail setting is made with E-mail function set to OFF, E-mail function cannot be used.

Move the cursor to “E-mail setting” on the Parameter setting screen and press the **(ENT)** key. On the E-mail setting screen that appears, make the settings required to use the E-mail function (SMTP IP address, Sender’s mail add, Name, Receiver’s add). Refer to the communication manual for details of the setting.

The screenshot shows the 'E-mail setting' screen with the following text and annotations:

```
E-mail setting
SMTP IP address :192.168. 2. 3
Sender's mail
Add : PHU@test. co. jp
Name : PHU USER
Receiver's mail
Add 1 : test1@test. co. jp
Add 2 : mail_taro@test. co. jp
Add 3 :
Add 4 :
Add 5 :
Add 6 :
Add 7 :
Add 8 :
(NOTE)
Please do not set the blank to the
E-mail address.
```

Annotations with arrows pointing to the corresponding lines:

- SMTP IP address setting (points to SMTP IP address)
- Sender's mail address setting (points to Add)
- Sender's mail name setting (points to Name)
- Receiver mail address setting (points to Add 1)

(2) E-mail trigger setting

Check that the E-mail function of the Ethernet setting is set to ON before carrying out the E-mail trigger setting. If the setting is made with E-mail function set to OFF, E-mail function cannot be used. Move the cursor to “E-mail trigger setting” on the Parameter setting screen and press the **(ENT)** key, and the E-mail trigger setting screen appears. Up to 10 patterns can be selected as E-mail send timing. Make the setting for E-mail send timing and the contents. Refer to the communication manual for details of the setting.

The screenshot shows the 'E-mail trigger 1 setting' screen with the following text and annotations:

```
E-mail trigger 1 setting
Trigger timing :DI ON
DI NO. :DI 2
Title :Product1 manufacturing beginning
Text 1 :Product1 manufacturing beginning
Text 2 :Boiler35
PV value, affixation :ON
Receiver's add No. : 1 2
Mail send test :Hit [ENT] key
```

Annotations with arrows pointing to the corresponding lines:

- Trigger timing setting (points to Trigger timing)
- DI No. setting (points to DI NO.)

(3) User account setting

The user account is used when security mode is in Logon mode and when FTP communication is made.

1) Explanation for use in Logon mode

When “Logon” is selected for security mode, logon can be made with the user name and the password.

The following operations are available depending on the operation level set for every user.

User level	Trend screen switching	Recording start and stop	Log ON / Log OFF	Parameter setting	User account mode switching	CF operation	Calibration	FTP file deletion
Administrator	○	○	○	○	○	○	○	○
Engineer	○	○	○	○		○		○
Operator	○	○	○			○		○
Guest	○		○			○		
No logon user	○		○					

○ : Available

(Note) When security mode is used in Logon mode, be sure to register a user in one Administrator level.

2) Explanation for use in FTP function

Check that FTP server function and FTP access control of Ethernet setting are set to ON before carrying out the user account setting. If the setting is made with FTP server function and FTP access control set to OFF, connection with the FTP server cannot be established. Note, however, that if common user name is ftp, connection with the FTP server can be established even if FTP access control is set to OFF.

Move the cursor to “User account setting” on the Parameter setting screen and press the **(ENT)** key, and the User account setting screen appears. The user name, password, and the access level for connection with the FTP server can be selected on the screen. Refer to the communication manual for details of the setting.

(Caution) Do not use blank space as a password.



8.14 Setting password for parameter setting

[Explanation]

Security mode is selected for the recorder.

A password is set when “Password” is selected for the security mode.

Four-digit password required to display the parameter setting screen and recording start and/or stop screen can be set as follows.

Set “0000”, then password input isn’t required to display above screens.

[Operation]

(1) Setting of security mode

Select a security mode between “Password” and “Logon”.

When the Logon mode is selected, operations are made as follows.

- When parameters are changed or recording is started/opped, the user name and the password should be input to log on to the recorder.
- User name, password and user level are set on the “User account setting “ screen.
- The following two methods are available for log off.
 - 1) Log off can be made on “Logon/Logoff” screen in the parameter setting screen.
 - 2) When no key is operated for 10 minutes, log off is made automatically.

(Note) When no user is registered in Administrator level, Logon cannot be selected for security mode.

(2) Setting of password

Select the “parameter setting” on the menu screen and enter the password, then select “Configuration Password set”.

Then following “Configuration Password set” screen appears.

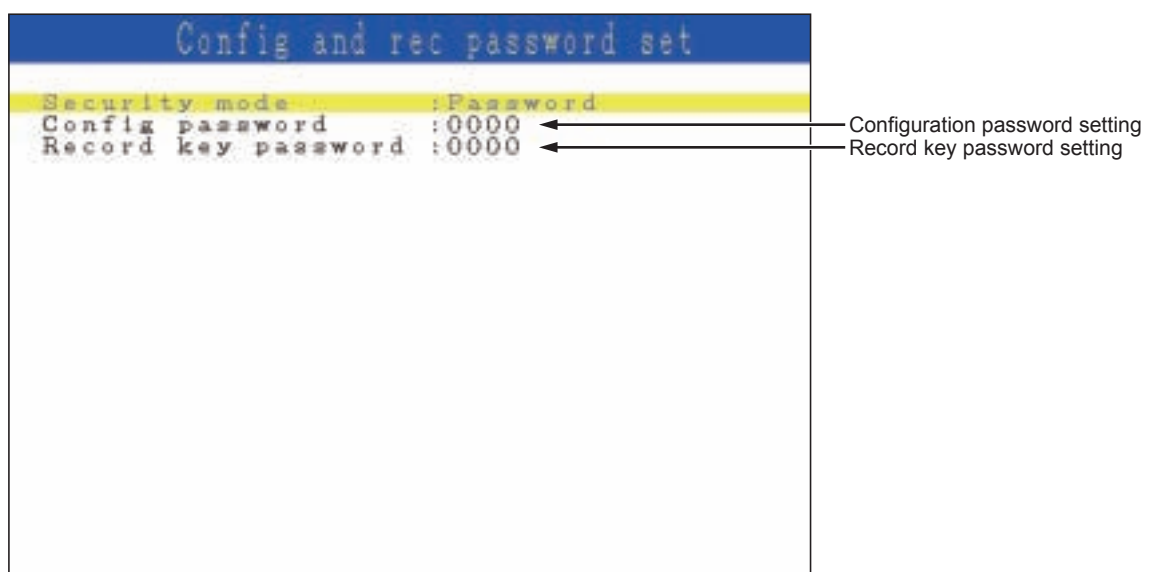

Press the **ENT** key, and password entry screen appears. Enter the password using the cursor key and press the **ENT** key.



9. OPERATING MEMORY CARD

9.1 Displaying record data of memory card

[Explanation]

The recorded data (trend data file) contained in the memory card set to the main unit can be displayed on the historical trend screen.

- The meaning of file name is as follows.
 - S00****.FDT: File name of the trend data file (A00****.FDT, which is an event data file, is not displayed.)

The part **** is substituted by 4-digit numerical value, and every time a new file is created, the value increases sequentially beginning from 0000.
- Every time a recording is started using the **REC** key or by DI input, a new file is created.

A trend file and an event file are created as a set as a new file without fail.
- The date indicates the last time when the writing was conducted on the file.
- The file name cannot be changed on this screen. To change the file name, read in the data in a memory card on the PC. Observe the following when changing the file name.
 - 1) Change both the trend data file (Sxx.FDT) and the event data file (Axx.FDT)
 - 2) Be sure to give the trend data file a name beginning with S, and give the event data file a name beginning with A.
 - 3) Be sure to give the same name to the part xxxx of Sxxxx.FDT and Axxxx.FDT. Otherwise the file may not be opened.
 - 4) The file may not be opened with the names S.FDT and A.FDT.
 - 5) Be sure to use 7 characters including S or A at the maximum. Otherwise the file may not be opened.
 - 6) Do not give the same file name to the part xxxx of Sxxxx.FDT and Axxxx.FDT in separate pairs.

Otherwise the program may not be properly operated and forced termination etc. may occur.

[Example]

Avoid giving the same file name, 88, to S88 in the upper stage and A88 in the lower stage as in the example shown below.

Before change

S01. FDT/A01.FDT	2002-11-19	10:00
S02. FDT/A02.FDT	2002-11-19	15:38

After change

<u>S88</u> . FDT/A01.FDT	2002-11-19	10:00
S02. FDT/ <u>A88</u> .FDT	2002-11-19	15:38

[Operation]

Select the “CF manager and totalize exe”. on the menu screen and enter the password if the CF manager password has been set, then select “Record data display”. Then following "Record data display" screen appears.

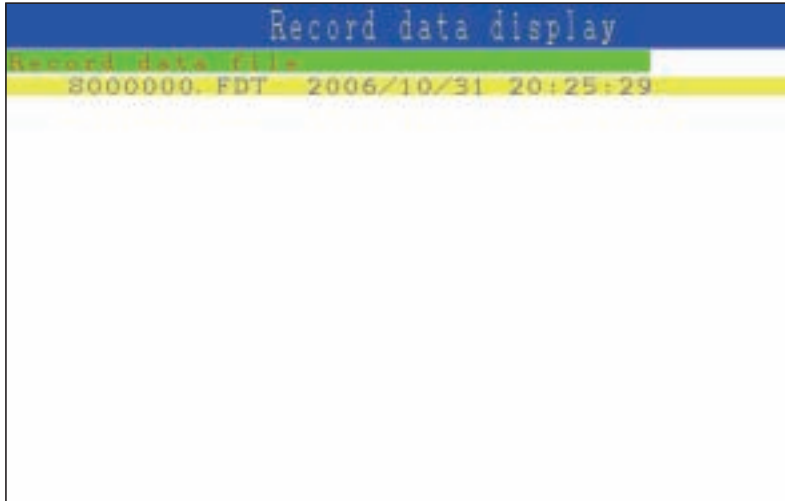

- (1) Select the file to be opened using the cursor key, and press the **(ENT)** key to display the following record data display screen.

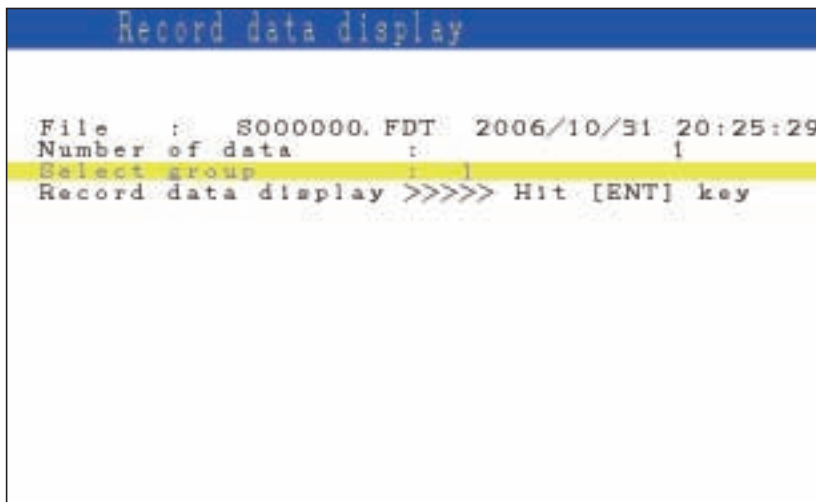

- (2) Select a screen group No. you want to display using the cursor key, and press the **(ENT)** key.



- (3) Move the cursor to “Record data display” and press the **(ENT)** key. Then move the cursor to “ON” and press the **(ENT)** key.

The historical trend screen of the selected group No. is displayed.

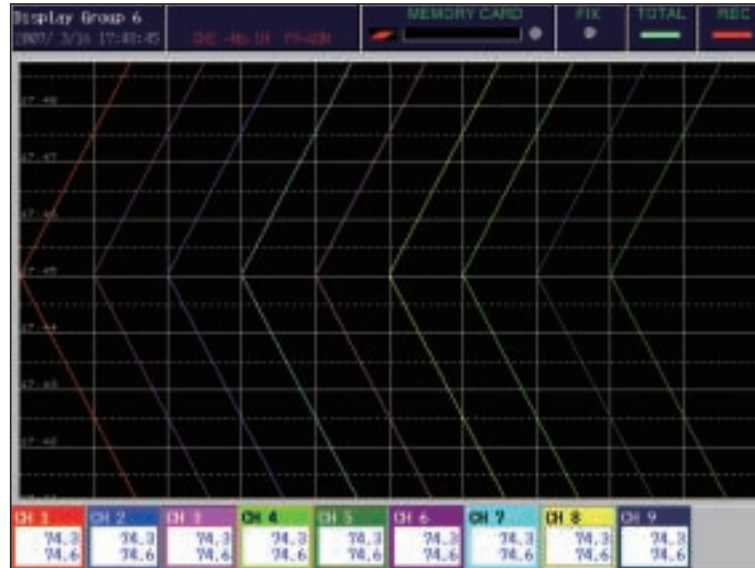

Refer to Item 5.8 “Historical trend display” for the method of seeing the historical trend screen.

About loading data from the memory card, following settings are displayed according to currently settings not the saved settings

- Trend direction
- Number of screen division
- Trend scale display
- Color bar display selection

- (4) Press the **(DISP)** key while the historical trend screen is displayed, and following “Display time setting” screen appears.

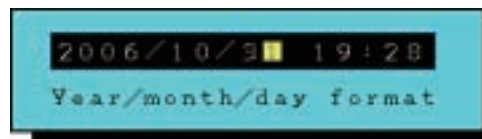

Enter the time of currently recorded data you want to display and press the **(ENT)** key.

Then, PHU displays historical trend data at entered day and time.

To display past data, entered day and time appears the bottom of the historical screen. To display farther data, entered day and time appear the top of this screen.

9.2 Removing memory card (compact flash)

[Explanation]

By prohibiting the writing to the memory card, the memory card can be removed without stopping the recording while recording or totalizing is in progress. Refer to [Operation] shown below for the removing procedure.

- If the internal buffer (memory) of PHU becomes full while the memory card is being removed, the record data is cut off.

- The internal buffer (memory) of PHU can store the data up to the following limit.

(1) Record data and event data: Approximately 5M bytes

In case of MAX-MIN recording, 4 bytes is required for 1 record data.

In case of instantaneous value and average value recording, 2 bytes is required for 1 record data. (When recording 36-channel in MAX-MIN recording, approximately 36,000 data can be stored. When the display refresh cycle is 1 second, data equivalent to 10 hours can be stored. Note that, the number of saved data change according to the number of event data.)

(2) Totalize data: Approximately 64k bytes

4 bytes are required for 1 totalize data. (When totalizing 36-channel, approximately 400 data can be stored. When totalizing once every 60 minutes in daily report, data equivalent to 400 hours can be stored.)

- When the memory card is reinserted after it is removed, a new record file (trend file, event file, or an totalizing file) is created.

[Operation]

Select the “CF manager and totalize exe.” on the menu screen and enter the password if the CF manager password has been set, then select “Memory card abstract”. The following message appears.

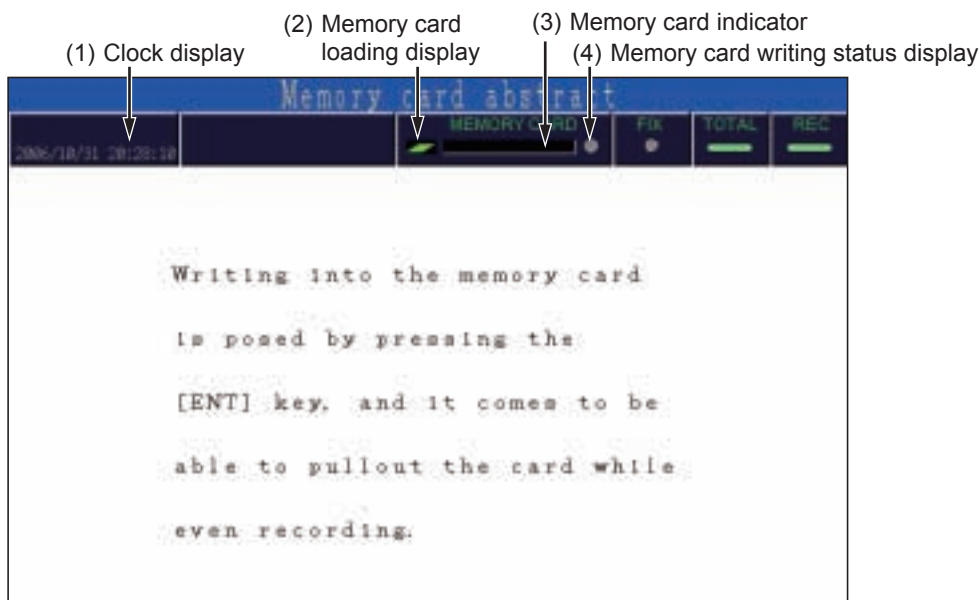

(1) **Clock display**

Displays the date and the time.

(2) **Memory card loading display**

Displays the memory card loading status.

Flashing: Indicates the state where a memory card is not inserted.

Lit in green: Indicates the state where the memory card can be removed.

Lit in red: Indicates the state where the memory card cannot be removed.

(3) Memory card indicator

Displays the usage of the memory card in a bar graph. Lit in red when 90% of the whole capacity has been used up.

(4) Memory card writing status display

Kept lit while the measured data is being written into the memory card.

Press the **(ENT)** key. The following screen appears and the writing into the memory card is prohibited. Check that the memory card loading display is lit in green. Then then remove the memory card and back up the recorded data. After that insert the memory card once again and press the **(ENT)** key. The parameter display screen appears and the prohibition of writing into the memory card is released.

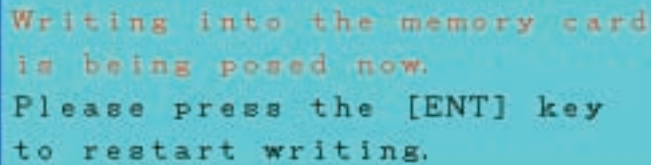

Writing into the memory card
is being posed now.
Please press the [ENT] key
to restart writing.

9.3 Totalizing start/stop setting

[How to start totalize operation]

- Totalize operation can be started from the “Channel setting” or “Math channel setting” screen. On the “Totalize setting” screen shown above, set “Totalize calculation” to other than off, and perform either one of the following to start recording.
 - 1) Set “Totalize start/stop” in “Menu/CF manager and Totalize exe.(/Password)/Totalize control” to ON and press the **(ENT)** key twice.
 - 2) Set “DI1 function” in “Menu/Parameter setting(/Password)/DI function setting” to “Totalize start/stop” and set DI1 to ON (in the case of the recorder with DI).

[Explanation]

Totalize record file

- A file for totalize recording is created by totalize type as shown by the following table. (Recording is made in the same format.)

Periodic cycle	T000000.FDT
Daily report	D000000.FDT
Weekly report	W000000.FDT
Monthly report	M000000.FDT
Annual report	Y000000.FDT
Daily report (at designated time)	R000000.FDT
External input	E000000.FDT

- A totalize file is created in a totalize folder (folder name: T000000) in the recording folder.
- A totalize file is newly created every time the base totalize operation is turned on.
- While totalize operation is in progress, a new totalize file is not created even if the power is turned off.
- The reference time of recording of daily report, weekly report, monthly report, etc. cannot be selected individually but should be synchronized.
- If power failure occurs and power is restored later during totalize operation, the operation resumes starting from the data before the power failure. (The data during the power failure is not totalized.)
- On totalize 4-channel display screen, totalize start/stop time and the previous totalized value are displayed.
- Totalizing data by the totalize recording cycle (and not the sum total during totalizing operation) is recorded in the totalizing file.
- The data can be totalizing to 9 digits.
- If an input error (such as Over, Under, Burnout, Error) occurs, 0 is totalizing. (the error input is not totalizing. However, if the input type is 0-5V input, and the input is kept open, the value equivalent to 0.26V is totalizing. If the input type is 0-500mV and the input is kept open, the value equivalent to 260mV is totalizing.)
- Displayed totalizing data is reset when the totalizing is started.

[Operation]

Select Menu/CF manager and Totalize exe.(/Password)/Totalize control, and press **ENT** key. Then totalize control screen appears.

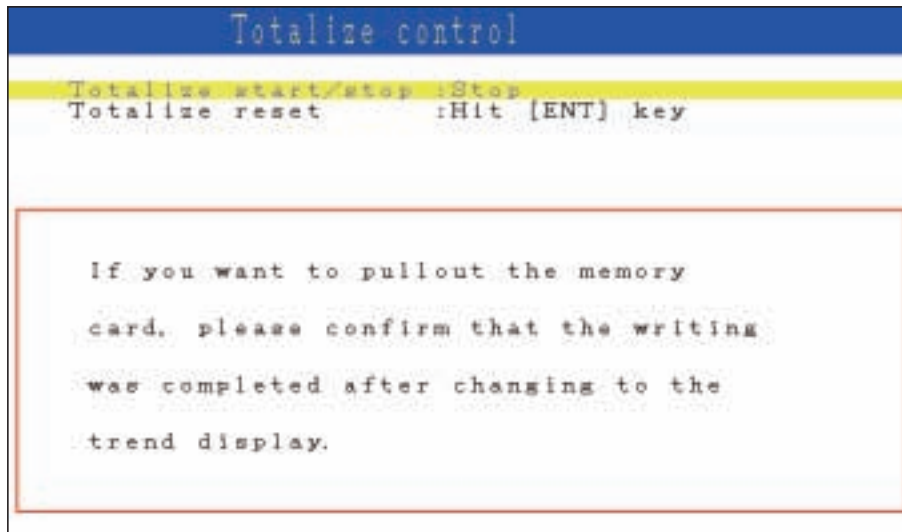

(1) To set totalize start/stop

Select "ON" or "OFF" at the parameter, "Totalize start/stop".

- If "Totalize start/stop" is set to "ON," totalizing is started when an totalizing start signal is received.
- If "Totalize start/stop" is set to "ON," some parameter cannot be set. Refer to Appendix 3.

(2) Totalize reset request

Select this parameter and press the [ENT] key, then all the current totalize values are reset to zero.

9.4 Function of reading settings from memory card (compact flash)

[Description]

The setting of the recorder can be read from the memory card.

Setting files (*****.PHU) can be created on the recorder main unit and the parameter loader. Setting files are stored in the PARAMET folder within the memory card. (See the following figure.)

Note: Settings cannot be read while recording or totalizing is in progress.

[Operation]

Move the cursor to “Parameter file load” on the CF manager and Totalize exe menu screen and press the **(ENT)** key, and the Parameter file load list screen appears.

Move the cursor to the file to be read and press the **(ENT)** key, and reading is started.

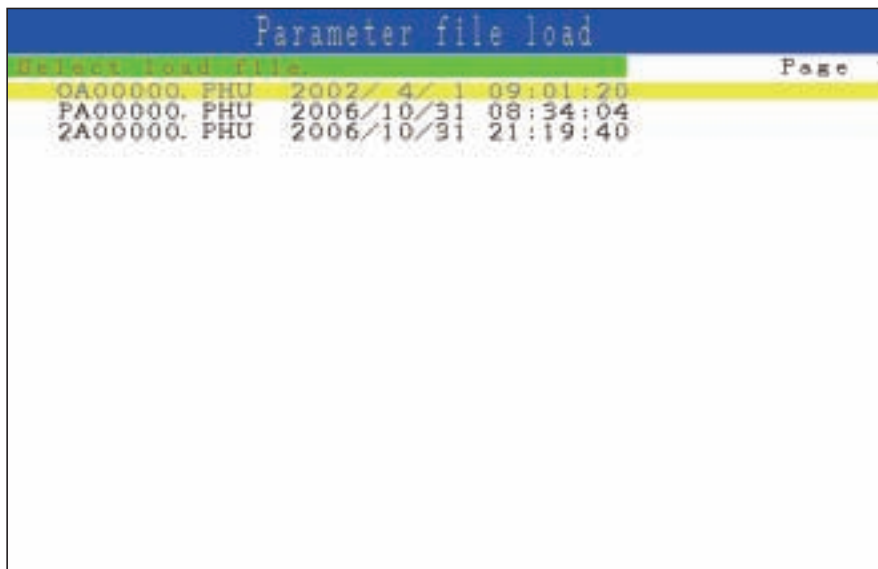

The screenshot shows a terminal window titled "Parameter file load" with "Page 1" in the top right corner. Below the title is a green bar with the text "Select load file.". The main area contains a list of files with their names, dates, and times:

File Name	Date	Time
QA00000.PHU	2002/4/1	09:01:20
PA00000.PHU	2006/10/31	08:34:04
2A00000.PHU	2006/10/31	21:19:40

On completion of the reading of the setting, the following message screen appears.

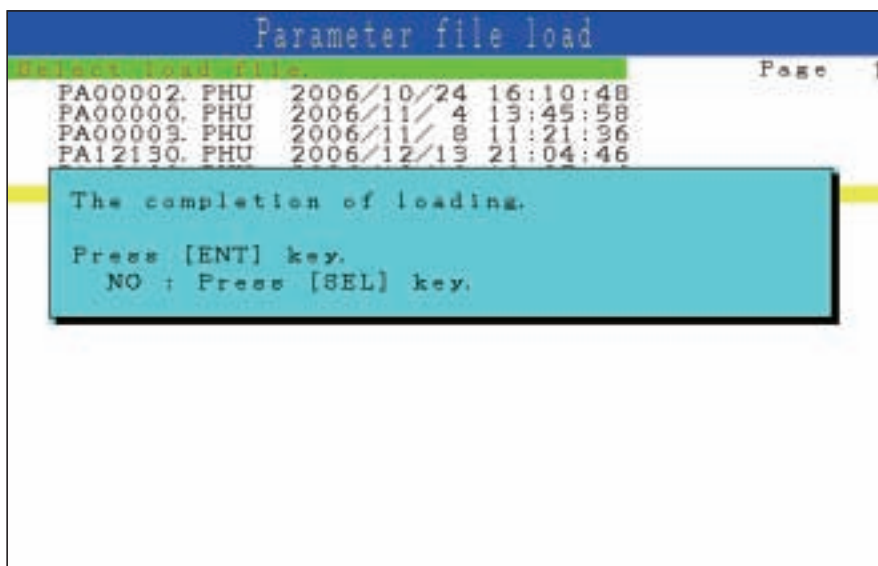

The screenshot shows the same terminal window as above, but with a cyan box overlaid on the bottom half. The box contains the following text:

```
The completion of loading.  
Press [ENT] key.  
NO : Press [SEL] key.
```

The list of files from the previous screenshot is still visible in the background above the cyan box.

9.5 Function of writing settings in memory card (compact flash)

[Description]

The setting of the recorder can be written in a memory card.

Setting files (*****.PHU) can be created on the recorder main unit and the parameter loader. Setting files are stored in the PARAMET folder in the memory card. (See the following figure.)

Note: A new setting file cannot be created if a file having the same name already exists within the memory card. (The setting file cannot be overwritten.)

[Operation]

Move the cursor to “Parameter file save” on the CF manager and Totalize exe menu screen and press the [ENT] key.

Move the cursor to “Save file name” and press the (ENT) key, and the character entry screen (see below) appears. Enter the file name using the cursor key and the (ENT) key. Then press the (ENT) key at [ENTRY] to confirm the entered file name.



Move the cursor to “Parameter save” and press the (ENT) key, and writing of the setting into the memory card is started.



On completion of the writing of the setting, the following message screen appears.

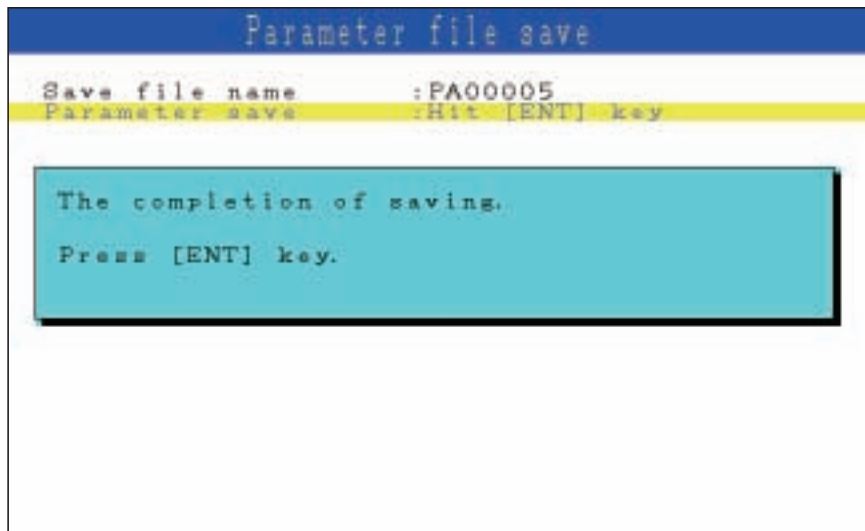

9.6 Setting password for memory card operation

[Explanation]

Four-digit password is required to display the “CF manager and Totalize exe.” screen can be set as follows.

The default setting is “0000.”

[Operation]

Select the “CF manager and totalize exe.” on the menu screen and enter the password if the CF manager password has been set, then select “CF manager password set”. The following “CF manager Password set” screen appears.

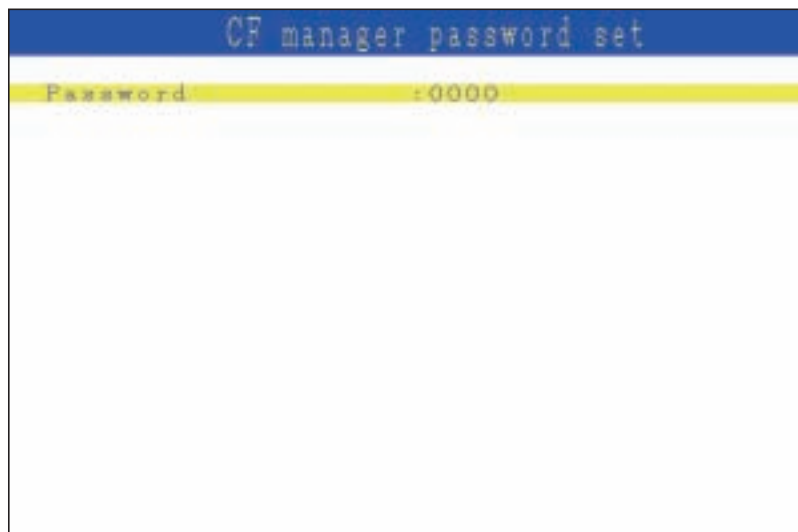

Press the **(ENT)** key, and the following password entry screen appears.

Enter the password and press the **(ENT)** key.



10. MAINTENANCE AND INSPECTION

10.1 Recommended replacement cycle of parts

Names of parts	Cycle	Remarks
LCD (front panel)	5 years	LCD backlight cannot be replaced as a single unit. Return to factory for repair.
Fuse (external use)	2 years	When external fuses are used, replace them every 2 years for preventive maintenance. Fuse rating: 250V AC, 2A
Memory card	6 months	<ul style="list-style-type: none">• To prevent data from being lost, back up the recorded data once every 6 months.• If writing error occurs in the memory card, data may be lost. If data has been written in the memory card to some extent, check if data writing has been normally performed.• The compact flash card is a consumable item. If the following phenomena take place, the card must have come to the end of its service life. Replace the card in such cases.<ol style="list-style-type: none">1) The number of recording file is found to be larger than expected even though power failure did not occur or recording was not interrupted.2) The recording file loaded into the PC cannot be opened with the data viewer.
Lithium battery	5 years	It cannot be replaced as a single unit. Return to factory for repair.

10.2 Calibration

To assure measuring accuracy, perform calibration every year.

For calibration procedure, refer to Chapter 11. Contact our sales representative for details.

10.3 Formatting the memory card

The memory card should be formatted by a personal computer (this recorder is not provided with a means of formatting the memory card).

Select a PC drive for the memory card and press the right-mouse button. The menu appears, prompting you to select the option. Select “Format” as FAT16 or FAT. On the screen that appears, select the “Start” button to initiate the formatting.

Using CF card adaptor, please check how many capacities it can deal with. If your CF card is out of the range, don't format CF card using the adaptor. When format CF card by the adaptor, you may find it complete format on the Windows. But in that case, PHU might not read the card.

11. CALIBRATION

The following operation can be carried out.

- (1) Calibration of the measured value
- (2) Initialization of the set value

11.1 Calibration method of measured values

[Preparation]

Before calibration, prepare equipment as shown below:

Equipment	Specification
Power supply	0 to 300Vac / 5A
Voltage Generator	0 to 50Vdc Resolution: 10 μ V (mV range) Output impedance: less than 2 Ω
Resistance decade box	Range: 0.01 to 400.000 Ω Resolution: 0.01 Ω
Digital voltage meter	Display: more than 5 and 1/2 digits Resolution: 1 μ V (mV range)

[Explanation]

Adjustment is not required in an ordinary status. However, to maintain the desired accuracy of the measured value display, we recommend you to perform calibration periodically by adding calibration input signals. Add calibration input signals to the channel to be calibrated. To calibrate the input of the resistance bulb, be sure to perform 500mV calibration beforehand, and then perform the calibration.

Note 1) If improper calibration input signals are added, the instrument operates improperly. Be sure to follow the procedure shown above to perform calibration. Otherwise the instrument may operate improperly.

Note 2) If the indication error is small, adjust the indication in “To set PV shift value” in Item 8.2 (12).

[Operation]

- (1) Select the “Calibration password” on the menu screen and enter the password, “1234”, then following “Calibration” screen appears.

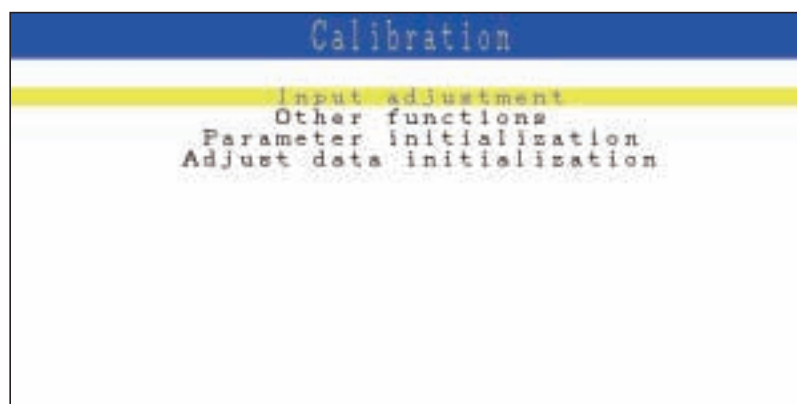

CAUTION

Do not perform “Other functions” and “Adjust data initialization”, since they are intended to be performed by the manufacturer. Otherwise the instrument may not operate properly causing phenomena that the input reading is not properly displayed or the set parameter returns to the value set at the time of delivery.

-
- (2) Move the cursor to “Input adjustment.” and press the **ENT** key, then the “input adjustment” screen appears.

In case of 0 to 5V input type

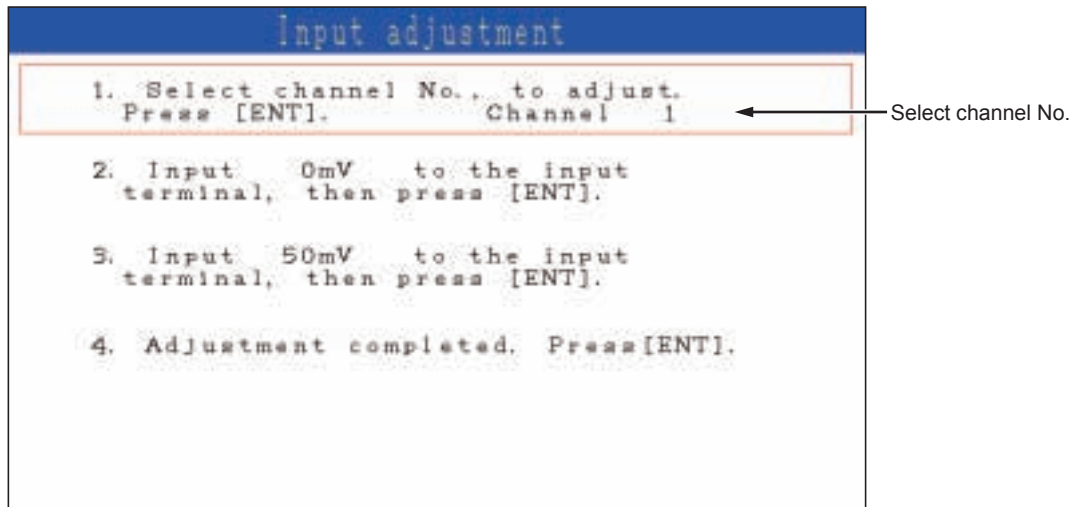

- (3) Select the channel for calibration.

Select the channel for calibration by using the cursor key and press the **ENT** key.

- (4) Apply 0% input

In the case of resistance bulb input, before performing calibration, be sure that 500mV input calibration has already finished.

The following are input signals for 0% point calibration.

- Voltage input: 0 mV or 0 V
- Thermocouple input: 0 mV
- Resistance bulb: 50Ω

After input of the input signal for 0% calibration, wait for 30 seconds. Then press the **ENT** key. Zero calibration will start automatically. After calibration, the “Setting completed” message appears. Pressing **ENT** moves to the next span calibration.

- (5) Apply 100% input

The input signal for 100% calibration is shown below;

- Voltage input: 50 mV or 500 mV, and 5V
- Thermocouple input: 50 mV
- Resistance bulb: 300Ω

After input of 100% calibration input signal, wait for 30 seconds. Then press the **ENT** key. Span calibration will start automatically. After calibration, the “Setting completed” message appears. Press the **ENT** key.

- (6) End of calibration

Move the cursor to “Adjustment completed” and press the **ENT** key.

11.2 Initializing the measured value

[Explanation]

Parameters can be returned to the value set at the time of delivery from the factory.

- After initializing the set value, be sure to store the initialized parameters in a nonvolatile memory. Otherwise they return to the values before the initialization when the power is turned off.

Note) Thought this function is executed, the adjusted values are not initialized.

[Operation]

- (1) Select the “Calibration password” on the menu screen and enter the password, then “Calibration” screen appears. After that, select “Parameter initialization”, then following “Parameter initialization” screen appears.



- (2) Press the **(ENT)** key to start initialization. To cancel it, press the **(SEL)** key.

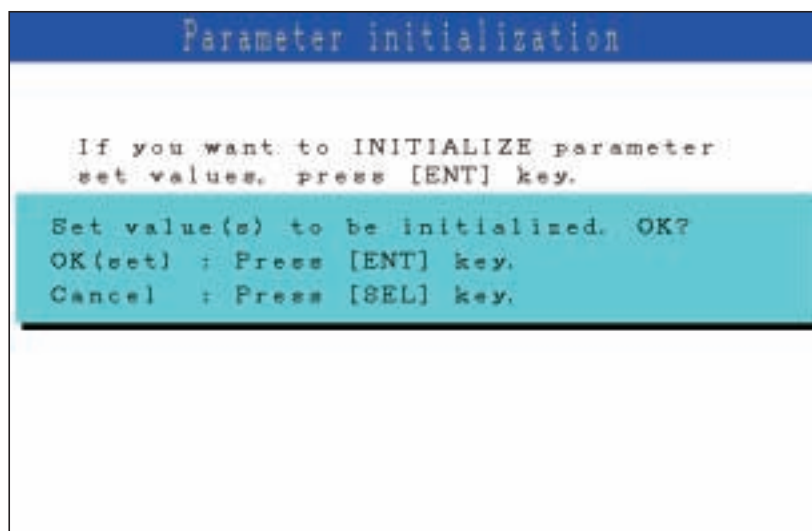

(3) Press the **ENT** key, and the setting value of parameters are initialized at the shipment.

```
Parameter initialize completed.  
Press [ENT] Key.
```

12. TROUBLESHOOTING

If the recorder does not operate normally, take a remedy according to the table given below. For a complicated trouble, contact our Sales Representatives.

Situation	Check	Remedy
Does not work at all.	1) Is the power supply terminal connection correct?	Connect correctly.
	2) Is power being supplied properly?	Supply correctly.
Keys do not work.	1) Does the screen display correctly? If keys only do not work, key switch may be faulty.	Contact our Service Center
	2) There are some parameters that cannot be set during recording. Check if setting has been attempted during recording.	Stop recording at once.
“System Error” is displayed when power is ON.	It is displayed when a fault occurs in CPU. Turn the power ON again. If it does not return to normal condition, CPU may be faulty.	Contact our Service Center.
The record swings over to the 0% side or the 100% side.	1) Is digital indication displayed correctly? If the input is not connected correctly, burnout may occur or over- or under-indication may occur	Connect correctly.
	2) The record swings over the indication range if the indication range is not set correctly.	Set the indication range correctly.
The indication changes too much.	To match the indication to that of the field indicator, use PV shift given in Item 8.2.	
The data indicator indicates “Over”, “Under” or “Error”.	1) If the input is not connected correctly or a signal that is different from the input type is connected, the indication becomes faulty.	<ul style="list-style-type: none"> • Connect correctly. • Set the input type according to the input signal.
	2) A value beyond the settable range is inputted. (Chapter 13. SPECIFICATIONS, Input system)	Measurement impossible.
Memory card is not recognized.	1) Is the format of compact flash FAT16?	Format to FAT16.
	2) Is compact flash made by SanDisk used?	Use compact flash made by SanDisk.
Recording data is not written in compact flash	1) Is the compact flash connected properly?	Fix the compact flash according to Item 2.2.
	2) Is the compact flash full?	
	3) If the measuring channel is set as “Indication only” or “Skip”, data is not recorded.	
“Memory card is full, Recording stopped. Please replace Memory card with a new one.” is kept displayed.	1) The compact flash has run out of capacity.	1) Replace the compact flash with the one with sufficient capacity, and then press the DISP key. 2) Press the DISP key.
	2) Was the DISP key pressed after the compact flash is replaced with the one with sufficient capacity?	

Situation	Check	Remedy
Record trend is not displayed.	1) Recording has not been started.	1) Press the REC key.
	2) No channel has been registered for the group displayed.	2) Make group registration by referring to Item 8.6.
	3) "Skip" has been selected as the input type of the channel registered for the group displayed.	3) Select an input type by referring to Item 8.2 (1).
	4) Long time (30 sec or 1 hour, for example) has been selected and displayed as an update interval.	4) Select a shorter refreshment cycle by referring to Item 8.1 (1).
	5) "Display Only" has been selected as the recording operation of the ch registered for the group displayed.	5) Select "With Record" by referring to Item 8.2 (17).
Display disappeared during operation.	Press any key.	1) Change the LCD OFF time according to the description in Item 8.1 (5).
	1) Not faulty if image appears.	
	2) May be faulty if image does not appear even if a key is pressed.	2) Contact our service center.

13. SPECIFICATIONS

1. Input system

Number of input points:

9, 18, 27 or 36 points (Can be selected at the time of purchase)

Input circuit:

Input mutual isolation (See "10. Others" in Chapter 13 for the withstand voltage)
Resistance bulb measured current:
about. 1 mA

Measuring cycles:

9 or 18 points....100ms cycles
27 or 36 points....200ms cycles

Recording cycle:

1 second to 12 hours

Input types:

Thermocouple, resistance bulb, DC voltage, and DC current (Shunt resistors are fitted in input terminals).
Note) Provide a shunt resistor (type: PHZP0101) separately.

Measuring range

Input types		Reference range
Thermocouple	B	400.0 to 1760.0°C
	R	0.0 to 1760.0°C
	S	0.0 to 1760.0°C
	K	-200.0 to 1370.0°C
	E	-200.0 to 800.0°C
	J	-200.0 to 1100.0°C
	T	-200.0 to 400.0°C
	N	0.0 to 1300.0°C
	W	0.0 to 1760.0°C
	L	-200.0 to 900.0°C
	U	-200.0 to 400.0°C
PN	0.0 to 1300.0°C	
Resistance bulb	JPt100	-200.0 to 600.0°C
	Pt100	-200.0 to 600.0°C
	Ni100	-60.0 to 180.0°C
	Pt50	-200.0 to 600.0°C
	Cu50	-50.0 to 200.0°C
DC voltage	50mV	0.00 to 50.00mV
	500mV	0.0 to 500.0mV
	1-5V	1.000 to 5.000V
	0-5V	0.000 to 5.000V

Note) B, R, S, K, E, J, T, N :
JIS C 1602, DIN IEC 584-1
W : 5%Re-26%Re · W
(Hoskins Mfg. Co. USA)
L : Fe-Cu · Ni (DIN 43710)
U : Cu-Cu · Ni (DIN 43710)
PN: Platinel
JPt100 : JIS C 1604-1989 (Old JIS Pt 100)
Pt100, Pt50 : JIS 1604, DIN IEC 751

Selection of input types:

By key operation on the front panel. Note that the same input type (thermocouple, resistance bulb, voltage) should be set every 2 channels. Refer to "Setting method of input types" for details.

Burn-out function:

Provided as standard for thermocouple and resistance bulb inputs. If the input has been open-circuited, the recording level swings over 100%.
Thermocouple burn-out current:
approx. 0.2 μ A

Input filter function:

Settable for each channel (primary delay filter)
Time constants are settable in the range from 0 to 900 sec.

Scaling function: Possible by DC voltage (current) input
Scaling range: -32767 to 32767
Decimal position:

settable at any point

Unit symbol: Selectable out of 125 different units or 12 user units of up to 7 characters.

Subtraction function:

Subtraction between each channel is allowed.

Totalizing function:

The measured value of each channel can be totalized. Applicable to daily, monthly, annual or external input totalizing.

F value calculation function:

F value (extinction value of bacteria by sterilization by heating) can be calculated from the measured temperature by each channel.

Square rooter function:

Square rooter can be performed against the input value per each channel.

Computation function:

The following calculation is available with the computation function.

(1) Computation function:

Addition, subtraction, multiplication, division, absolute value, exponential, square-root extraction, LOG, LN, EXP, humidity, maximum, minimum, average, and integration.

(2) Computation input enable:

Analog input (Ch1 to 72), integration input (Ch1 to 72), DI (DI1 to 16), communication input (No.1 to 36), and constant number (No.1 to 60).

2. Indication system

Indicator:

12" TFT color LCD (800 x 600 dots) with backlight, no contrast adjustment. On the LCD, certain picture elements remain lit or extinguished. On account of the nature inherent to LCD, the brightness may be non-uniform. But, such are not troubles.

Color of indication:

14 colors

Applicable language:

English, French (switchable)

Life of backlight: 50,000 hours in terms of total lighting time.

(Replace the backlight as a set of display unit. If the LCD extinguishing function is resorted to, the LCD can be used longer as much.)

Trend display:

Direction: vertical and horizontal
Number of channels: 10, 6 or 4 channels per screen group. (Input: 72 points at the maximum).
Display refreshment cycles:
select from 1 second to 12 hours
Scale display or no-display can be selected.

Bar graph display:

Number of channels: 10, 6 or 4 channels per screen group. (Input: 72 points at the maximum).

Display refreshment cycles: 1 second

Analog meter display:

Number of channels: 10, 6 or 4 channels per screen group. Display in bar graphs or in analog meters can be selected.

Display refresh cycle: 1 second

Digital display:

Number of channels: 10, 6 or 4 channels per screen group. (Input: 72 points at the maximum).

Display refreshment cycles: 1 second

Totalizing data display:

Number of channels: 10, 6 or 4 channels per screen group. (Input: 72 points at the maximum).

Display refresh cycle: 1 second

Event summary display:

Alarm summary and message summary can be displayed. The message occurrence information and message display can be switched.

Ethernet log display:

E-mail sending, FTP server log in/off and MODBUS TCP/IP communication start/stop can be displayed.

Parameter display/set:

Already-set Data Display and Set Change Display screen

TAG indication:

Number of characters to be displayed:

Up to 8 characters

Up to 8 characters (Note 1) at 10 or 6 channel display.

Up to 16 characters at 4 channel display.

Note 1: Up to 7 characters only can be displayed on certain screens.

Characters to be displayed:

Alphanumerics

Tag, unit and channel No. display:

Which can be displayed depends on the particular screen. Refer to the table below. (Keywords only are extracted.)

Screen	Channels per screen	Item			
		Tag 1	Tag 2	Unit	ch Np.
Trend	4 or less	All			
Bar graph	5, 6	○	—	○	○
	7 or more	×	—	×	×
Analog meter	6 or less	All			
	7 or more	○	—	○	○
Instantaneous value		All			

○ : Displayed

× : 1 item only can be displayed

— : Nothing can be displayed

Historical trend display:

Displays past recording data read from compact flash, currently recording data or just recorded data. The recording chart can be scrolled or, via time designation, the control can jump to an arbitrary recording chart.

Number of screen groups:

8 groups (Up to 10 channels per 1 group can be registered.)

3. Keyboard

No. of Keys: 8

Function: Use to select various screens and set various parameters.

4. Recording function

External memory media:

Compact Flash card

Format according to FAT16 or FAT. Otherwise, reading and saving are impossible.

Recording capacity:

512 MB maximum (compact flash). Limiting the recording file to 64 MB is recommended (for 112 hours if display refresh cycle is 1 second. See Table 1 (p. 13-6).)

If impossible, up to 256 MB is tolerated. A file recorded beyond could not be opened.

* Only the SanDisk's compact flash is warranted. And please change the compact flash every six month to prevent the data losing.

Recording method:

Turning ON the REC key allows measured data to be written at fixed cycles.

Recorded as a new file whenever the recording starts.

Data save cycles:

Linked to the display refreshment cycles on the "Real Time Trend" screen. However, they are automatically set to about 1 minute if the refreshment cycles are set to less than 1 minute.

Trend data:

Measurement data sampled at measurement cycle is saved in terms of mean value, instantaneous value or maximum/minimum value.

Event data:

Saves alarm data and message data.

Further saves power ON and OFF, if any, after starting recording.

Totalizing value data:

Totalizing value data at designated timing is recorded per channel.

Totalized value data at designated totalized value recording cycle or the sum total is recorded in the totalizing file. You can choose which type you want to record.

For each channel, it can be selected as totalizing action from Analog input totalization, Digital input count or period of Digital input ON, and it can be selected as totalizing period type from Dairy, Weekly, Monthly, Annual, Periodic, Dairy (time set) or External input signal.

Even if a power failure occurs during totalization and then the power is restored, the totalization restarts from the value before power failure.

Configuration data:

Configuration data can be saved. And this data can also download to recorder.

Storage capacity :

Approximately 1.5 years when the display refresh cycle is 30 seconds (in case of 9-channel recording in ASCII data format, and 256 MB compact flash used). Refer to Table 1.

Residual capacity of memory:

Indicates how much of the memory card has been used on the screen. If the residual capacity is none, the recording stops.

Compact flash:

Manufactured by SanDisk
URL: <http://www.sandisk.com>
Type: SDCFB-256 (256MB)
Available at any PC shops

Data format:

Either of ASCII or binary format can be selected. (Switching cannot be made while the recording is in progress. In the case of ASCII format, the data can be directly read on Excel, etc. The data recorded in binary format cannot be read directly.)
Approximately 166 bytes per sampling for maximum/minimum recording of 9-channel input in ASCII format, or approximately 40 bytes for maximum/minimum recording of 9-channel input in binary format.

5. Alarm function

- No. of settings:** Up to 4 alarms for each channel are settable.
- Type of alarm:** High/Low limits
- Indication:** Status (alarm types) is displayed on digital display unit when an alarm occurs. Historical display on alarm summary (Alarm start/cancel time and alarm types)
- Hysteresis:** Set within the recording range of 0 to 100%
Acts on high or low limit alarm, and does not affect the battery alarm nor memory full alarm.
- Relay output:** Number of points; 20 (option: Up to 2 cards with relay output can be mounted.)
- Transistor output (open collector output):** 16 points (option)
- Alarm latch function:** Holds alarm indication and alarm output even after measurement value has left the alarm range.
ON/OFF operation is performed according to key setting.

6. Power supply

- Rated power voltage:** 100 to 240V AC
- Range of operating voltage:** 90 to 264V AC
- Supply frequency:** 50/60Hz $\pm 2\%$ (both employable)

Power consumption

Power voltage	Consumption
100V AC	About 65VA
240V AC	About 80VA

7. Structure**Mounting method:**

Panel-mounted (vertical panel)

Thickness of panel:

2 to 26 mm

Materials:

Stainless steel for case, PC-ABS for bezel

Color:

Silver for case, Munsell N2.0 (black) for bezel

External dimensions:

300 (W) \times 300 (H) \times 220.5 (D) mm

Mass:

About 4.7 kg (9-point input, without option)
About 6.4 kg (full option)

External terminal board:

Input terminal: M3 screw terminal
Power terminal: M4 screw terminal

8. Operating condition**Power supply voltage:**

90 to 264V AC

Power supply frequency:

50/60Hz $\pm 2\%$ (sharing)

Ambient temperature:

Without Ethernet function: **0 to 50°C***1
With Ethernet function: **0 to 40°C***2

Ambient humidity:

20 to 80%RH

Vibration:

10 to 60Hz 0.2m/s² or less

Shock:

None

Magnetic field:

400 A/m or less

Signal source resistance:

Thermocouple input 1k Ω or less
Resistance bulb input 10 Ω /wire or less (resistance of each wire of 3-wire system should be balanced).
Voltage input 0.1% or less of input resistance

Mounting posture:

Forward tilt 0, backward tilt within 30, horizontal 0

Warm-up time:

One hour or more after power ON

*1: In case of the 12th digit of ordering code is "Y".

*2: In case of the 12th digit of ordering code is "E".

9. Reference standard

Accuracy/resolution:

Measuring conditions (23±2°C, 65±10% RH, power voltage, frequency fluctuation within ±1%, no external noise, warm-up time of 1 hour or more, vertical mounting, standard values of signal source resistance and wiring resistance... within 1%)

Input types		Digital indication accuracy Note 1	Digital indication resolution
Thermocouple	B	±(0.15%+1 digit) ±(0.3%+1 digit) for the range shown below Thermocouple B : 400 to 600°C Thermocouples R and S : 0 to 300°C Thermocouples K, E, J, T, L and U : -200 to -100°C	0.1°C
	R		
	S		
	K		
	E		
	J		
	T		
	N		
	W		
	L		
	U		
PN			
Resistance bulb	JPt100	±(0.15%+1 digit)	0.1°C
	Pt100		
	Pt50		
DC voltage	Ni100	±(0.5%+1 digit)	10V
	Cu50		
DC voltage	50mV	±(0.15%+1 digit)	100V
	500mV		
	5V		
			1mV

Note 1) Digital indication accuracy is a percentage (%) with respect to input range of 1 page.

Note 2) No error of reference contact compensation of thermocouple is included.

Error of reference contact compensation:

K, E, J, T, N, L, U, PN: ±0.5°C

R, S, B, W: ±1.0°C

(when measured at 0°C or more)

Max. input voltage:

Thermocouple, resistance bulb,
DC voltage: ±10V DC (continuous)

Input impedance:

Thermocouple,
DC voltage: About 1MΩ

10. Others

Clock:

With calendar function (Christian era)
Accuracy: ±50 ppm or less (monthly error: about 2 minutes)
However, time error at power ON/OFF is not included.

Memory backup:

Parameters are saved to the internal non-volatile flash memory.
The clock is backed up with built-in lithium battery.
Trend data is not backed up.

Insulation resistance:

100 MΩ (when measured between each terminal and ground by using a 500V DC megger)

Withstand voltage:

Input terminal – input terminal:
500 V AC, 1 min
Power terminal – ground:
2000V AC, 1 min
Input terminal – ground:500V AC, 1 min
Alarm terminal (contact output) – ground:
2000 V AC, 1 min
Alarm terminal (contact output) – alarm terminal (contact output):
750 V AC, 1 min
Communication terminal – ground:
500 V AC, 1 min
Alarm terminal (open collector) – ground:
500 V AC, 1 min
Power terminal – input terminal:
500 V AC, 1 min

11. Effect on operation

Effect of power supply fluctuation conditions:

For the fluctuation in the range from 90 to 264V AC (frequency: 50/60Hz)
Reading change: ±(0.2%+1 digit) or lower.
For the fluctuation in the range from 47 to 63Hz (power voltage: 100V AC)
Reading change: ±(0.2%+1 digit) or lower.

Effect of input signal resistance:

Thermocouple input: 50μV±1 digit per 100Ω
DC voltage: Fluctuation for resistance value equivalent to 0.1% of the input resistance: ±(0.2%+1 digit) or lower.
Resistance bulb (for wiring resistance of 10Ω for 1 line (the same for 3 lines))
Reading change: ±(0.2%+1 digit) or lower.

Effect of ambient temperature:

Reading change: ±(0.3%+1 digit)/10°C or lower.

Effect of Mounting position:

For the backward 30° slant
Reading change: ±(0.2%+1 digit) or lower.

Effect of vibration:

When sine wave of 10 to 60Hz with the acceleration of 0.2m/s² is applied in each direction for 2 hours.
Reading change: ±(0.2%+1 digit) or lower.

12. Safety and EMC standard

Safety standard: Based on IEC61010-1

EMC standard: Based on EN61326

13. Transportation/storage conditions

Temperature: -10 to +60°C
Humidity: 5 to 90%RH
Vibration: 10 to 60Hz, 2.45 m/s² or lower
Shock: 294m/s² or lower (packed state)

14. Additional function (option)

■ Alarm relay output (11th digit of code symbols: "1", "2", "4" or "5")

Up to 2 cards with 10-point relay output can be mounted. (Maximum 20 points)

Terminal structure:

M3 screw terminal

Alarm relay output:

1a contact output (10 points/card), Individual channel or common output (OR output) allowed.

Rating: Contact capacity 240V AC/3A, 30V DC/3A (Resistive load).

■ Alarm open collector output (11 digit of code symbols is "3", "4" or "5")

Card having 16 alarm points (open collector output) can be mounted.

Terminal structure:

M3 screw terminal

Alarm output:

Open-collector transistor output (16 points)

Rating: 30V DC/0.1A (resistance load)

■ DI input (7 digits of code symbol is "1")

Card having 16 DI input can be mounted.

Terminal structure:

M3 screw terminal

DI input:

No-voltage contact input (16 points).

Contact input allows following controls.

- (1) Recording start/stop
- (2) Message set
- (3) F value calculation reset
- (4) Totalizing start/stop
- (5) Totalized value reset
- (6) LCD (backlight) lighting
- (7) E-mail sending

Input pulse width:

ON pulse width: 400msec or more
OFF pulse width: 400msec or more

15. Ethernet (Option)

The following can be performed through the Ethernet function.

■ HTTP server (Internet Explorer 6 is available) ^{Note 1}

Measurement display:

Digitally displays the measurement of each channel of the recorder and alarm occurrence status.

Event summary display:

Displays event summary including alarm ON/OFF and issuance of messages.

Main unit information display:

Displays memory use conditions and information on the main unit such as the battery end warning.

Integrated value display:

Digitally displays the integrated value of each channel of the recorder.

■ FTP server (Internet Explorer 6 available.) ^{Note 1}

File download: Record files stored in compact flash (CF) can be downloaded from the browser.

File delete: Record files stored in CF can be deleted from the browser.

Access authentication:

Authenticates access authority to FTP server.

■ SMTP (e-mail client)

Transmits e-mails to specified address under the following conditions.

- (1) When an alarm turns on or off
- (2) When DI is set to ON or OFF
- (3) When an error occurs to the main unit (such as low battery or no memory space)
- (4) At specified intervals

■ MODBUS TC/IP

Data read: Settings can be read through MODBUS TCP/IP communication.

Data write: Settings can be written through MODBUS TCP/IP communication.

Note1: Neither Netscape nor Mozilla Firefox are available.

16. Support software

The following software is provided as standard.

- Applicable PC: PC/AT-compatible machine
- Operation on PC98-series machines by NEC is not guaranteed.
- Operation on self-made or shop-brand PCs is not guaranteed.

■ Loader software for PC

Major function: Performs various parameter setting/change of the main unit

O/S: Windows 2000/XP (Windows Vista is not supported.)

Required memory:

64MB or larger

Disk drive: Windows 2000/XP-capable CD-ROM

Hard disk capacity:

Free capacity of 30MB or larger required

Printer: Windows 2000/XP-capable printer and printer driver

Note) PC loader communication cable (type PHZP1801) is separately required.

■ Data viewer software

Major function: Regenerates the past trend record on the PC from the data in the compact flash.

Provided with historical trend display and event display functions.

Data can be changed to CSV file.

O/S: Windows 2000/XP (Windows Vista is not supported.)

Required memory:

64MB or larger

Disk drive: Windows 2000/XP-capable CD-ROM drive

Hard disk drive: Free capacity of 30MB or larger required

Printer: Windows 2000/XP-capable printer and printer driver

17. Standard functions

Function	Description
Record range voluntary setting	Recording range can be set by channel.
Input type setting	Input type can be set by channel. (Key operation on the front face) Set the same input type for every 2 channels.
Skip function	Skips arbitrary channel display/recording.
Trend display	Time display: Time is displayed at the top of the trend display screen. Alarm display: On occurrence of an alarm and the restoration, alarm is displayed in the alarm display field. The compact flash usage is displayed with a bargraph at the top.
TAG name display	By channel, Maximum of 8 characters.
Screen name display	Displays the screen name (maximum of 16 characters).
Unit creation	Industrial units can be arbitrarily created, Maximum of 7 digits, 12 types.
Scaling function	Arbitrary scaling is allowed in the case of DC voltage input. Decimal point position can also be arbitrarily set in the range from -32767 to 32767.
PV shift	Shift the zero point and slant of the reading.
Input filter	Prevents sudden fluctuation of input for each channel (primary delay filter). Time constant: 0 to 900 seconds.
Burnout function	Displays the break of thermocouple/resistance bulb input by scaling out to 100% side.
Historical trend display	Regenerates and displays the data stored in the compact flash by scrolling the screen. Displays data of a designated time.

When compact flash is not used, up to 6M bytes of the recording data and the event data can be stored in the main unit. (In case of 32-channel in Max./Min. recording, approximately 400,000 data can be stored. For 11 hours at the display refresh cycle of 1 second. The number of the save data varies depending on the number of the event data.

18. Table 1. Recording capacity

The recording can be made for the period of time listed in the tables shown below under the following conditions.

- 9 input points
- Recording data format: ASCII
- Recording type: Maximum/minimum recording
- No alarm, nor message, nor other events.

CompactFlash size	64MB				
Display upgrade cycle	1 sec	10 sec	30 sec	1 min	10 min
Recordable capacity (about)	112 hours	46 days	140 days	280 days	7.7 years

CompactFlash size	256MB			
Display upgrade cycle	1 sec	10 sec	30 sec	1 min
Recordable capacity(about)	18 days	187 days	1.5 years	3 years

- When the number of input points goes on increasing, the period becomes as follows.
 - 18 input points; The period is approximately one half of those listed in the table.
 - 27 input points; The period is approximately one-third of those listed in the table.
 - 36 input points; The period is approximately one-fourth of those listed in the table.
- In binary format, the period is approximately 4 times as long as those listed in the table.
- For recording type of mean or instantaneous value, the number of days is approximately 2 times as long.

APPENDICES

Appendix 1 Recording format (ASCII)

(1) Trend data file

Ver. V06U	Parameter set values, channel No., TAG name, recorded color, input types, units, display range (0%), display range (100%), etc. of each channel	CH35MIN, CH35MAX, CH36MIN, CH36MAX	CH37MIN, CH37MAX, CH38MIN, CH38MAX	CH39MIN, CH39MAX	CH40MIN, CH40MAX, CH41MIN, CH41MAX, CH42MIN, CH42MAX, CH43MIN, CH43MAX, CH44MIN, CH44MAX, CH45MIN, CH45MAX, CH46MIN, CH46MAX, CH47MIN, CH47MAX, CH48MIN, CH48MAX, CH49MIN, CH49MAX, CH50MIN, CH50MAX, CH51MIN, CH51MAX, CH52MIN, CH52MAX, CH53MIN, CH53MAX, CH54MIN, CH54MAX, CH55MIN, CH55MAX, CH56MIN, CH56MAX, CH57MIN, CH57MAX, CH58MIN, CH58MAX, CH59MIN, CH59MAX, CH60MIN, CH60MAX
S001446.FDT PHU41B11-E10EY SNo.0000					
36.00.00.00.08	.01.31.mV	0.0	500.0.0.0	0.0	0.0.0.0.0
CH01.TAG 02	.02.40	0	5000.0.0	0	0.0.0.0.0
CH02.TAG 02	.03.31.mV	0.0	500.0.0.0	0.0	0.0.0.0.0
CH03.TAG 02	.04.31.mV	0.0	500.0.0.0	0.0	0.0.0.0.0
CH04.TAG 02	.11.31.mV	0.0	500.0.0.0	0.0	0.0.0.0.0
CH05.TAG 02	.10.31.mV	0.0	500.0.0.0	0.0	0.0.0.0.0
CH06.TAG 02	.05.31.mV	0.0	500.0.0.0	0.0	0.0.0.0.0
CH07.TAG 02	.06.31.mV	0.0	500.0.0.0	0.0	0.0.0.0.0
CH08.TAG 02	.08.31.mV	0.0	500.0.0.0	0.0	0.0.0.0.0
CH09.TAG 02					
CH35.TAG 35	.11.01.BC	0.0	1200.0.0.0	0.0	0.0.0.0.0
CH36.TAG 36	.10.01.BC	0.0	1200.0.0.0	0.0	0.0.0.0.0
G1. Display Group 1	.01.02.03.04.05.06.07.08.09.10	0.0	0.0.0.0.0.0.0.0.0.0.0	0.0	0.0.0.0.0.0.0.0.0.0.0
G2. Display Group 2	.10.11.12.00.00.00.00.00.00.00				
G3. Display Group 3	.07.08.09.10.11.12.00.00.00.00				
G4. Display Group 4	.01.02.03.04.05.06.07.08.09.00				
G5. Display Group 5	.01.02.03.04.05.06.07.08.09.00				
G6. Display Group 6	.01.02.03.04.05.06.07.08.09.00				
G7. Display Group 7	.01.02.03.04.05.06.07.08.09.00				
G8. Display Group 8	.01.02.03.04.05.06.07.08.09.00				
2007/ 4/10 17:33:17	100.0	221	221	221	221
2007/ 4/10 17:33:18	100.0	221	221	237	237
2007/ 4/10 17:33:19	100.0	237	253	270	270
2007/ 4/10 17:33:20	100.0	253	270	286	286
2007/ 4/10 17:33:21	100.0	270	286	303	303
2007/ 4/10 17:33:22	100.0	286	303		

Note) Data such as burn-out, error, and time of occurrence are recorded as -32768 (with decimal point). Over-/under range Indication is recorded as 32767/-32767 (with decimal point).

(2) Event data file

A000014.FDT : File name
 PHU41B11-E10EY : Type
 SNo.0000 Ver.V06U : Board
 2002/ 4/18 23:32:00,A,01,2,02,1
 2002/ 4/18 23:32:00,M,Low temperature attention ,01
 2002/ 4/18 23:45:22,A,03,3,01,1
 2002/ 4/18 23:45:22,M,Humidity is abnormal. ,01
 2002/ 4/18 23:47:21,A,03,3,01,0
 2002/ 4/18 23:47:28,A,03,4,02,1
 2002/ 4/18 23:47:28,M,Humidity is abnormal. ,01
 2002/ 4/19 00:39:46,A,03,4,02,0
 2002/ 4/19 00:41:26,A,01,2,02,0
 2002/ 4/19 00:41:26,M,Low temperature attention off ,01
 2002/ 4/19 00:42:27,A,03,4,02,1
 2002/ 4/19 00:42:27,M,Humidity is abnormal. ,01
 2002/ 4/19 00:43:12,A,03,4,02,0
 2002/ 4/19 00:52:37,A,01,1,01,1
 2002/ 4/19 00:52:37,M,High temperature attention ,01
 2002/ 4/19 02:05:58,A,01,1,01,0
 2002/ 4/19 02:05:58,M,High temperature attention off ,01
 2002/ 4/19 02:42:38,A,01,2,02,1
 2002/ 4/19 02:42:38,M,Low temperature attention ,01
 2002/ 4/19 02:55:48,A,03,3,01,1
 2002/ 4/19 02:55:48,M,Humidity is abnormal. ,01
 2002/ 4/19 02:57:51,A,03,3,01,0
 2002/ 4/19 02:57:57,A,03,4,02,1
 2002/ 4/19 02:57:57,M,Humidity is abnormal. ,01
 2002/ 4/19 03:50:02,A,03,4,02,0
 2002/ 4/19 03:51:40,A,01,2,02,0
 2002/ 4/19 03:51:40,M,Low temperature attention off ,01
 2002/ 4/19 04:02:53,A,01,1,01,1
 2002/ 4/19 04:02:53,M,High temperature attention ,01
 2002/ 4/19 05:16:14,A,01,1,01,0
 2002/ 4/19 05:16:14,M,High temperature attention off ,01

Message data

"Occurrence of alarm" data
 Year, month, day, time, type (A), channel No., alarm No.
 Alarm types (1: H, 2: L)
 Alarm start (1) and alarm cancel (0)

Appendix 2 Parameters that cannot be set during recording

Channel parameters	Input types Units Scaling (measuring range, engineering unit) Square rooter TAG Display color Display range Recording types Recording mode F value calculation function F value calculation decimal point
Recording parameters	Display refreshment cycles File division cycle File overwrite function Trend display compression function Display naming Display structure
Unit parameters	Clock Record data format
Functions that cannot be used during recording	Channel parameter copying function Parameter initialization Reading the setting value from compact flash Math channel parameter copying function
Calculation channel parameter	Computing equation Units Scaling (measuring range, engineering unit) Square rooter TAG Display color Display range Recording types Recording mode F value calculation function

Appendix 3 Parameters that cannot be set while totalizing is underway

Channel parameters	Totalizing type Totalizing calculation mode External input Totalizing unit time Totalizing reset mode Totalizing TAG Totalizing unit Totalizing lower limit cut value Totalizing divisor
Totalizing parameters	Integrated time for daily report Base date for annual report External input signal
Unit parameter	Clock Recorder data format
Functions that cannot be used during integration	Initializing setting value Loading setting value from compact flash
Calculation channel parameter	Totalizing type Totalizing calculation mode External input Totalizing unit time Totalizing reset mode Totalizing TAG Totalizing unit Totalizing lower limit cut value Totalizing divisor

Appendix 4 Opening the PHU record data in ASCII format on Excel

Note 1) Binary format record data cannot be opened with the method shown below. (See Item 8.1 (16) To set record data format for details.)

Note 2) The record data of 5MB or larger in case of 9-point input, and 10MB or larger in case of 18-point input cannot be opened on Excel. In these cases, read the data using the data viewer (contained in the attached CD-ROM) and perform CSV conversion to divide the file, which allows the data to be read.

(1) Start up Excel, select “File(F)” and the “Open (O)” on the menu to display the following screen.

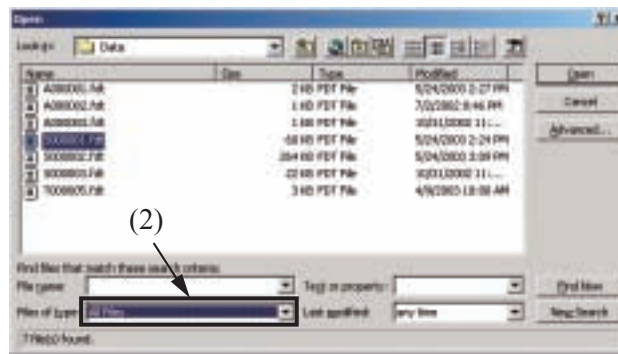

(2) Select “All” for the file type, and select PHU record data (S****.FDT).

(3) Selecting the file displays the following data format setting screen. Select “Dividing characters such as a comma or a tab....” for the original data format, and then press the “Next” button.

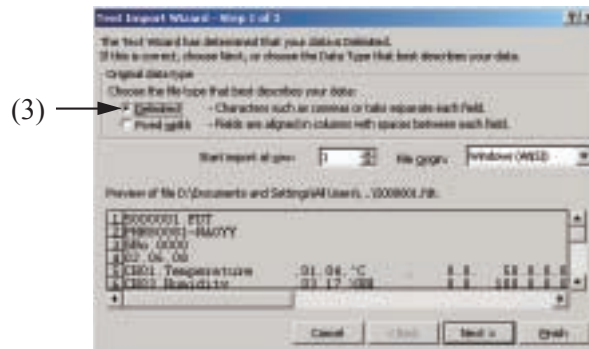

(4) Pressing the “Next” button displays the following screen.

Check “Comma (C)” in the dividing character setting.

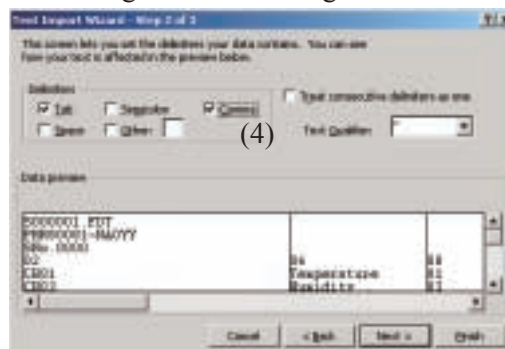

(5) Pressing the “Exit (E)” button displays the record data of PHU.

Appendix 5 Timing of recording

The timing of recording varies depending on display refresh cycle and integration record cycle.

Example: When the recording is started at 08:45 at the display refresh cycle of 20 minutes, the data is recorded next when the clock indicates 0, that is, at 09:00. The recording will thus be performed at 09:20, 09:40, 10:00etc.

Display refresh cycle	Data is recorded when the PHU clock indicates the following time.
1 second	Every second
2 seconds	Every even-numbered second
3 seconds	At 0, 3, 6, 9, 12, 15, 18, 21, 24, 27, 30, 33, 36, 39, 42, 45, 48, 51, 54, 57 seconds
5 seconds	At 0, 5, 10, 15, 20, 25, 30, 35, 40, 45, 50, 55 seconds
10 seconds	At 0, 10, 20, 30, 40, 50 seconds
20 seconds	At 0, 20, 40 seconds
30 seconds	At 0, 30 seconds
1 minute	Every minute (When 0 is displayed. The same for the following)
2 minutes	Every even-numbered minute
3 minutes	At 0, 3, 6, 9, 12, 15, 18, 21, 24, 27, 30, 33, 36, 39, 42, 45, 48, 51, 54, 57 minutes
5 minutes	At 0, 5, 10, 15, 20, 25, 30, 35, 40, 45, 50, 55 minutes
10 minutes	At 0, 10, 20, 30, 40, 50 minutes
20 minutes	At 0, 20, 40 minutes
30 minutes	At 0, 30 minutes
1 hour	Every hour (When "0 m :0 s" is displayed. The same for the following)
2 hours	Every even-numbered hour
3 hours	At 0, 3, 6, 9, 12, 15, 18, 21 hours
4 hours	At 0, 4, 8, 12, 16, 20 hours
6 hours	At 0, 6, 12, 18 hours
12 hours	At 0, 12 hours

Fuji Electric Systems Co., Ltd.

Head Office

Gate City Ohsaki, East Tower, 11-2, Osaki 1-chome,
Shinagawa-ku, Tokyo 141-0032, Japan
<http://www.fesys.co.jp/eng>

Instrumentation Div.

International Sales Dept.

No.1, Fuji-machi, Hino-city, Tokyo 191-8502, Japan
Phone: 81-42-585-6201, 6202 Fax: 81-42-585-6187
<http://www.fic-net.jp/eng>
