



TS[®] 25D

Test Set

Users Guide

PN 2451820

October 2005, Rev. 6 6/2017

©2005, 2009, 2012, 2013, 2015-2017 Fluke Corporation

All product names are trademarks of their respective companies.

LIMITED WARRANTY AND LIMITATION OF LIABILITY

Each Fluke Networks product is warranted to be free from defects in material and workmanship under normal use and service unless stated otherwise herein. The warranty period for the mainframe is 18 months and begins on the date of purchase. Parts, accessories, product repairs and services are warranted for 90 days, unless otherwise stated. Ni-Cad, Ni-MH and Li-Ion batteries, cables or other peripherals are all considered parts or accessories. The warranty extends only to the original buyer or end user customer of a Fluke Networks authorized reseller, and does not apply to any product which, in Fluke Networks' opinion, has been misused, abused, altered, neglected, contaminated, or damaged by accident or abnormal conditions of operation or handling. Fluke Networks warrants that software will operate substantially in accordance with its functional specifications for 90 days and that it has been properly recorded on non-defective media. Fluke Networks does not warrant that software will be error free or operate without interruption.

Fluke Networks authorized resellers shall extend this warranty on new and unused products to end-user customers only but have no authority to extend a greater or different warranty on behalf of Fluke Networks. Warranty support is available only if product is purchased through a Fluke Networks authorized sales outlet or Buyer has paid the applicable international price. To the extent permitted by law, Fluke Networks reserves the right to invoice Buyer for repair/replacement when a product purchased in one country is submitted for repair in another country.

For a list of authorized resellers, visit www.flukenetworks.com/wheretobuy.

Fluke Networks warranty obligation is limited, at Fluke Networks option, to refund of the purchase price, free of charge repair, or replacement of a defective product which is returned to a Fluke Networks authorized service center within the warranty period.

To obtain warranty service, contact your nearest Fluke Networks authorized service center to obtain return authorization information, then send the product to that service center, with a description of the difficulty, postage and insurance prepaid (FOB destination). Fluke Networks assumes no risk for damage in transit. Following warranty repair, the product will be returned to Buyer, transportation prepaid (FOB destination). If Fluke Networks determines that failure was caused by neglect, misuse, contamination, alteration, accident or abnormal condition of operation or handling, or normal wear and tear of mechanical components, Fluke Networks will provide an estimate of repair costs and obtain authorization before commencing the work. Following repair, the product will be returned to the Buyer transportation prepaid and the Buyer will be billed for the repair and return transportation charges (FOB Shipping point).

THIS WARRANTY IS BUYER'S SOLE AND EXCLUSIVE REMEDY AND IS IN LIEU OF ALL OTHER WARRANTIES, EXPRESS OR IMPLIED, INCLUDING BUT NOT LIMITED TO ANY IMPLIED WARRANTY OF MERCHANTABILITY OR FITNESS FOR A PARTICULAR PURPOSE. FLUKE NETWORKS SHALL NOT BE LIABLE FOR ANY SPECIAL, INDIRECT, INCIDENTAL OR CONSEQUENTIAL DAMAGES OR LOSSES, INCLUDING LOSS OF DATA, ARISING FROM ANY CAUSE OR THEORY.

Since some countries or states do not allow limitation of the term of an implied warranty, or exclusion or limitation of incidental or consequential damages, the limitations and exclusions of this warranty may not apply to every buyer. If any provision of this Warranty is held invalid or unenforceable by a court or other decision-maker of competent jurisdiction, such holding will not affect the validity or enforceability of any other provision.

4/15-18

Fluke Networks
PO Box 777
Everett, WA 98206-0777
USA

Contents

Title	Page
Introduction	1
Registration	1
Contacting Fluke Networks	1
 Safety Information	1
Design Features	2
Differences Between TS25D and TS25D CO Models	2
Physical Characteristics	2
Speaker	4
Belt Clip	4
Line Cord	4
Battery	4
Headset	4
Display Icons	4
Modes and Functions	6
Monitor Mode	6
Talk Mode	6
Data Lockout	6
Data Lockout Override	7
High Voltage Lockout	7
Low Voltage Lockout	8
Talk Battery	8
Caller ID/Call Waiting ID	9
Toner	9
DTMF Detection	10
Call and Dialing Functions	10
Originating a Call	10
Answering a Call	10

Disconnecting a Call	10
Last Number Redial	11
Memory Dialing	11
Speed Dialing (TS25D CO)	11
Memory Programming	11
Call List	13
Configuring the Test Set	13
Settings Screen	13
Tone/Pulse Dialing	14
Timing	14
Pause Duration	14
Flash Duration	14
System Timeout	14
Speaker Timeout	14
Data Lockout	15
Firmware Version	15
Factory Settings	15
Maintenance	16
Keypad Care	16
Replacing the Battery	16
Replacing the Line Cord	17
Specifications	18

TS[®]25D Test Set

Introduction

Caution

Legal requirements may exist regarding permission to connect equipment to a Telecom network operated by a public network operator.

The TS25D Test Set is a lightweight portable test telephone used by installers, repair technicians and other authorized personnel for temporary communication and for servicing and installing analog voice telephone lines.

Registration

Registering your product with Fluke Networks gives you access to valuable information on product updates, troubleshooting tips, and other support services. To register, fill out the online registration form on the Fluke Networks website at www.flukenetworks.com/registration.







Contacting Fluke Networks

-  www.flukenetworks.com
-  info@flukenetworks.com
-  1-800-283-5853, +1-425-446-5500
-  **Fluke Networks**
6920 Seaway Boulevard, MS 143F
Everett WA 98203 USA

Fluke Networks operates in more than 50 countries worldwide. For more contact information, go to our website.

Safety Information

The following IEC symbols are used either on the test set or in the manual:

	Caution: Risk of damage or destruction to equipment or software. See the manual for details.
	Warning: Risk of electric shock. Risk of personal injury.
	Earth ground
	Conformité Européenne. Conforms to relevant European Union directives.
	Consult the user documentation.
	40 year Environment Friendly Use Period (EFUP) under China Regulation - Administrative Measure on the Control of Pollution Caused by Electronic Information Products. This is the period of time before any of the identified hazardous substances are likely to leak out, causing possible harm to health and the environment.
	Do not put products containing circuit boards into the garbage. Dispose of circuit boards in accordance with local regulations.

Warning

Do not use the test set if it is damaged. Before you use the test set, inspect the case. Look for cracks or missing plastic. Pay particular attention to the insulation surrounding the connectors.

Do not use test leads if they are damaged. Examine the test leads for exposed metal and damage to the insulation. Make sure the wear indicator on the cords does not show. The wear indicator is the white layer below the outer, braided layer. Verify the continuity of the test leads.

If this product is used in a manner not specified by the manufacturer, the protection provided by the product may be impaired.

Design Features

Design features of the TS25D Test Set include:

- Three main modes: Talk (off-hook), Monitor (on-hook and listening), and Off
- Data Lockout and Override
- Low and High Voltage Lockout
- Last Number Redial
- Mute Function
- Hook Flash
- Memory Dialing
- Tone and Pulse Dialing
- Displays Voltage when on-hook
- Displays Current when off-hook
- Polarity Indication
- Detect and Display Caller ID/Call Waiting ID (CIDCW)
- Toner
- Talk Battery
- DTMF Detection including A-D
- Headset Compatible
- Field Replaceable Battery
- Field Replaceable Line Cord

Differences Between TS25D and TS25D CO Models

The information in this guide applies to the standard TS25D Test Set and the TS25D CO (Central Office) Test Set, except where noted. Differences between the two models are described in the following sections:

- Speaker, page 4.
- Belt Clip, page 4
- Line Cord, page 4
- Speed Dialing, page 11
- System Timeout, page 14
- Speaker Timeout, page 14

Physical Characteristics

Figure 1 and the following sections describe the tester's features.

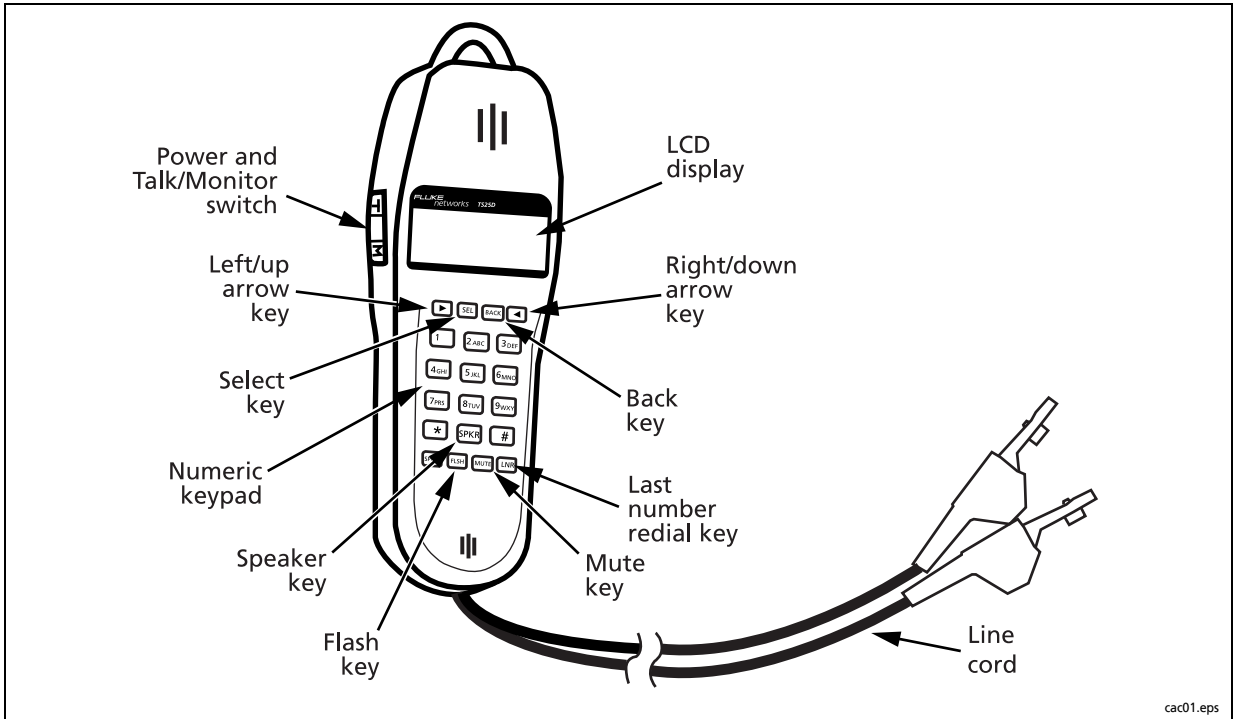

cac01.eps

Power and Talk/Monitor switch	Puts the test set in Talk (T) or Monitor (M) mode. The center position turns the test set off.
Arrows keys	The left/up arrow key moves the LCD display's cursor left or up. The right/down arrow key moves the cursor right or down.
SEL	The SEL (Select) key selects the highlighted menu entry. It also lets you enter the menu from Talk or Monitor modes.
BACK	The BACK key lets you go backwards through the menus. Pressing BACK also turns off the Toner and Talk Battery functions.
Numeric Keypad	The numeric keypad is used to dial telephone numbers and make function selections. The keypad includes 12 standard dialing keys, the asterisk (*) key, and pound (#) key.
SPKR	The SPKR (speaker) key turns the speaker on, increases its volume, and turns the speaker off.
FLSH	The FLSH (flash) key causes a timed interruption of the loop current. Hook flashing is commonly used for call waiting functions on residential lines. Some PBX setups or telephone office switches may use this signal to put a call on hold or to activate a special function. The FLSH key is also enters a pause when entering telephone numbers in the test set's memory.
LNR	To redial the most recently dialed number, take the test set off-hook then press LNR (Last Number Redial).
MUTE	The MUTE key mutes and unmutes the microphone (handset or headset).

Figure 1. Physical Characteristics

Speaker

The TS25D Test Set's speaker allows hands-free listening in both Talk and Monitor Mode. Pressing the **SPKR** key will turn the speaker on. Pressing the **SPKR** key again will increase the speaker's volume. Pressing the **SPKR** key a third time will turn the speaker off.

On the standard TS25D Test Set, the speaker turns off when you switch between Monitor and Talk modes. If you turn off the test set while the speaker is on, the speaker will be off next time you turn on the test set.

On the TS25D CO Test Set, the speaker stays on when you switch between Monitor and Talk modes. If you turn off the test set while the speaker is on, the speaker will be on next time you turn on the test set.

Caution

Be sure the test set is not near your ear when you turn on the speaker, as the volume can be quite loud.

Belt Clip

An optional battery door with a belt clip is available for the standard TS25D Test Set. For information on availability of the optional belt clip, contact your local Fluke Networks distributor.

The TDS25D CO Test Set has a belt clip on the battery door.

Line Cord

Caution

Always handle the clip leads and the cables by their insulation, NEVER directly by the exposed metal of the test clips. Use only the insulated clips provided to connect to any wire or cable.

See Figure 1.

The test set is equipped with a field replaceable line cord. The line cord is attached to the test set at the transmitter end of the test set.

The line cord included with the standard TS25D Test Set has angled bed-of-nails clips. The line cord included with the TS25D CO Test Set has a 346A plug. Extension line cords for the 346A plug are sold separately.

For information on availability of line cords, contact your local Fluke Networks authorized distributor.

Battery

The battery compartment is on the back of the tester. See "Replacing the Battery" on page 16.

Note

If the test set fails to operate properly at any time, first replace the battery and retest before sending the test set in for repair.

A 9 V alkaline battery must be installed for the test set to operate. Do not use rechargeable batteries.

When the battery icon shows a low battery, the battery has anywhere from a few hours to several days of life remaining depending on how the test set is used. The battery will be used up much faster if the Talk Battery function or the speaker is used.

If the test set ever stops working, replace the battery. If it still doesn't work, contact Fluke Networks Technical Support.

Headset

On the TS25D Test Set, an audio jack is available for the connection of a headset. The 3.5 mm jack is located on the side of test set. The TS25D Kit (Model 25501109) comes with a headset.

For information on availability of additional headsets or replacement headsets, contact your local Fluke Networks authorized distributor.

Display Icons

Figure 2 describes the icons used on the LCD display.

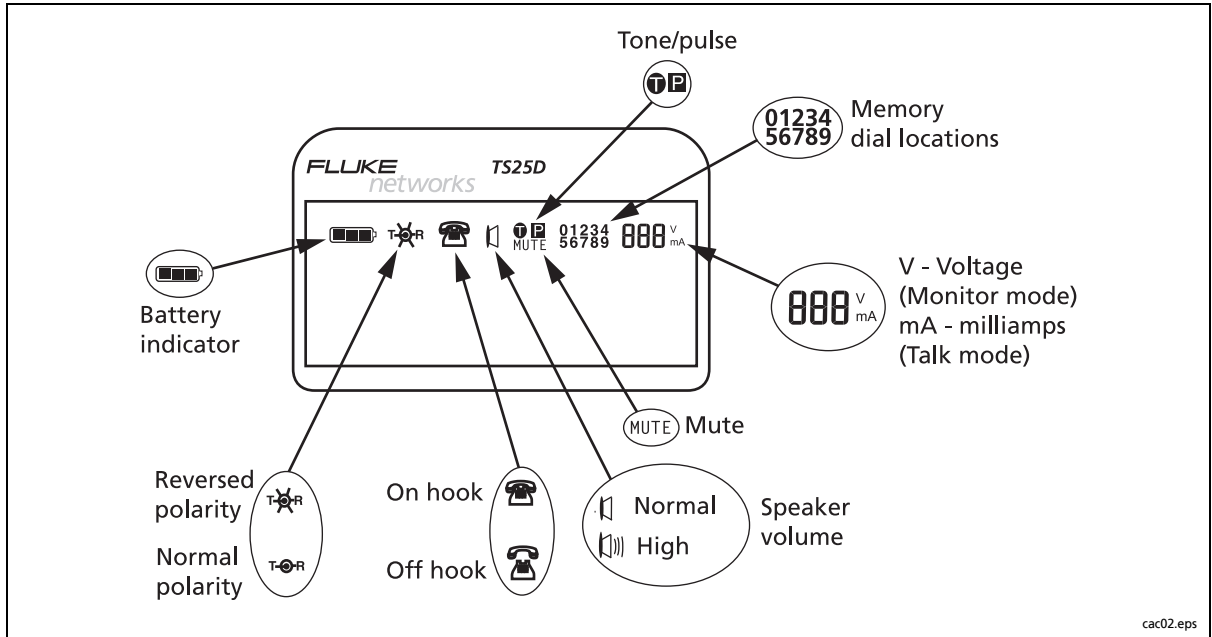

Polarity	In Monitor or Talk mode, the polarity icon indicates the dc polarity of the line. The Tip-Ring icon with no X indicates the red test lead is connected to the Ring (negative) side of the line and the black test lead is connected to the Tip (positive) side of the line. When the Tip-Ring polarity icon has an X through it, the test leads are reversed; that is, the red test lead is connected to the Tip (positive) side and the black test lead is connected to the Ring (negative) side. No icon appears when the leads are disconnected or the line is not powered.
Battery	The battery icon indicates the battery's charge level. The battery level is continuously displayed in Monitor and Talk mode.
On/off hook	The telephone icon tells you if the test set is on or off hook.
MUTE	The MUTE icon appears when the microphone is muted.
Tone/Pulse	In tone mode the icon is a T ; in pulse mode it is a P .
Speaker volume	The speaker icon appears when the speaker is on.
Memory dial locations	The test set lets you store 10 numbers in ten memory locations (0 through 9). The icon shows the number of the active memory location.
V mA	The test set displays the voltage across Tip and Ring when the test set is on-hook. The test set displays the current it draws from the line when off-hook. Voltmeter range: 0 Vdc to 250 Vdc Current meter range: 0 mA to 110 mA

Figure 2. TS25D Test Set Icons

Modes and Functions

Warning

When testing circuits which are close to a battery source, the pops in the handset receiver that result from clipping onto a line may be quite loud. Although there is protection against acoustic shock built into the test set, if the receiver is held tightly against the ear, acoustical shock may occur.

Monitor Mode

Monitor mode is primarily for audio monitoring of the Tip and Ring pair while on hook. In Monitor mode, the test set has a high input impedance, which allows monitoring of the line without disrupting conversations or data signaling if present. The test set draws no direct current from the line and it transmits no signals to the line. Also, in Monitor mode, the TS25D monitors for high-speed data signals on the line. If the test set detects data it will display **DATA DETECTED** on the LCD. If there is no high-speed data on the line, the LCD will display **NO DATA**.

In Monitor mode, the test set is typically used to perform one or more of the following procedures:

- Verification that a line is idle when looking for a line to borrow
- Listening for noise on the line
- Performing a test for the presence of high frequency data on the line
- Measuring the DC voltage from Tip to Ring
- Detecting DTMF signals
- Monitoring line polarity

The TS25D will respond to incoming ringing signals when it is in Monitor mode. It does not detect ringing signals when it is off.

Talk Mode

When the test set is connected to a working analog telephone line and is switched to Talk mode, the test set will go off-hook and draw dial tone. An off-hook TS25D test Set works like a standard telephone. When off-hook, the test set is used to perform its main purpose, which is to verify the proper operation of analog voice telephone lines or to establish temporary communications on a “borrowed” pair.

In both Talk and Monitor mode you can change the receiver’s volume level by pressing the Up or Down arrow keys.

Each time the test set is switched to Talk mode, it quickly tests the line for high-speed data and for DC voltage before it goes off-hook. If there is no high-speed data on the line, and there is enough DC voltage to go off-hook on (>3 V), the test set will go off-hook without you ever noticing that the tests have been performed.

Occasionally you may run into the situation where you have accidentally connected to a line carrying high-speed data or where you have connected to a line with either too little or too much DC voltage to go off-hook on. The data and voltage tests are designed to detect these conditions and are discussed in the following sections.

Data Lockout

When the test set is switched to Talk mode, it tests the line for high-speed data signals and for DC voltage before it goes off-hook. If data is detected in the frequency band from 20 kHz to about 1 MHz, the test set will refuse to go off-hook and the LCD will display **DATA DETECTED, DOWN ARROW TO OVERRIDE**. This mode is called Data Lockout mode. In the Data Lockout mode, the test set is kept on-hook, “locked out”, despite having been switched to Talk Mode. Data Lockout Mode prevents accidental corruption of data transmissions while working in modern telecommunications cable environments that have a mix of analog telephone and data services.

There is often no way to know by inspection or by audio monitoring if the wire pair you are connecting to is a high-speed data line or not. Most high-speed data is above the human hearing range so listening to the line in Monitor mode may not allow you to identify it as a data line. If you see the **DATA DETECTED** message, chances are you have accidentally connected to a data line. If so, disconnect the test set from the line, being careful not to short the clip leads together in the process.

Caution

If you have accidentally connected to a data line, do not press the down arrow because overriding will cause the test set to go off-hook and take the data service down.

In some situations you may want to go off-hook, as described in the next section.

Data Lockout Override

Caution

Shorting the Tip and Ring leads together while connected to a data line will cause disruption to the data.

Whenever you try to go off-hook on a high-speed data line, the TS25D Test Set will go into Data Lockout mode and will not go off-hook. This is to protect data services, most of which would be corrupted by loading the line with the low impedance of an off-hook telephone. But ADSL (Asymmetrical Digital Subscriber Line) is a different circumstance.

ADSL is a high-speed data service intentionally designed to co-exist on the same wire pair as standard analog telephone service. If you try to go off-hook on a wire pair carrying both ADSL and analog telephone service, the TS25D Test Set will detect the ADSL data signal and go into Data Lockout mode as it would on any data line. You will see the message **DATA DETECTED, DOWN ARROW TO OVERRIDE**. Now, if you want to go off-hook to access the analog phone service sharing the line with ADSL, press the down arrow as instructed on the LCD.

The test set will override the lockout, will go off-hook and draw dial tone without disturbing the co-existing ADSL service. The TS25D Test Set has circuitry that protects the ADSL service when it is off-hook. Going off-hook on ADSL lines is the most common use of Lockout Override.

There is another case where the override function may be needed. You may encounter the rare circumstance where the analog telephone line you connect to is not carrying any data but there is enough high frequency noise on the line that the TS25D Test Set thinks there is high-speed data on the line. If you know you are connected to such a line, use the Lockout Override function to go off-hook. This usually only happens when the telephone line is near a commercial AM radio broadcast antenna.

There is a provision for turning the data lockout function off. When Data Lockout is turned off, the test set will go off hook on a powered line when switched to Talk (T), even if data is present. When Data Lockout is off, the test set will still detect data in Monitor mode. To learn how to turn Data Lockout on and off, refer to the System Configuration section.

High Voltage Lockout

Caution

Do not short the test set leads to each other while it is connected to a line carrying high voltage.

The TS25D Test Set is designed for use in environments where analog voice lines co-exist with lines that carry high DC voltages. When the TS25D Test Set is switched to Talk mode, it tests the line for high-speed data and it measures the DC voltage on the line before it goes off-hook. If the DC voltage exceeds 140 V, the test set will prevent itself from going off-hook and will display **HIGH VOLTAGE LOCKOUT**.

Going off-hook on a line carrying a high dc voltage can damage the power supply feeding the line. The test set will prevent this from occurring. Unlike the data lockout, there is no provision for the operator to override a high voltage lockout. Lines with voltages exceeding 140 Vdc do not carry analog voice services. If you encounter a high voltage lockout, switch the Talk/Monitor switch back to Monitor (M) and carefully remove the test leads from the line.

Low Voltage Lockout

Each time the test set is switched to Talk mode, it tests the line for high-speed data signals and it measures the DC voltage on the line before it goes off-hook. If there is less than 3 V on the line, there is not enough voltage for the test set to go off-hook and the LCD will display **LOW VOLT LOCKOUT, DOWN ARROW FOR TALK BATTERY**.

The Low Voltage Lockout message indicates that there is very little or no voltage on the telephone line — not enough voltage for the test set to perform off-hook operations. The most common cause of this message is when the test set is switched to Talk mode and it is either not connected to anything or it is connected to an un-powered pair of wires (dry loop). In this state you have the option of activating the test set's Talk Battery function.

There is one additional line condition that should be mentioned. When the test set, connected to a line carrying data signals but no DC voltage, is switched to Talk mode, the LCD will display **DATA DETECTED AND LOW VOLT LOCKOUT**. Some data services have no associated DC voltage. The low impedance of the TS25D Test Set's off-hook state would corrupt these types of services. Thus the test set does not have any provision to override the lockout when this line condition is encountered.

In any of the test set's lockout states, removing the test set from the line condition that is causing the lockout automatically clears the lockout condition.

Talk Battery

The TS25D Test Set can power a dry telephone wire pair to enable voice communications between itself and another test telephone connected to the other end of the pair. After turning on Talk Battery at your end, the person at the other end should take his test set off-hook. If the test set at the other end has talk battery capability, it should not be enabled.

The Talk Battery function provides the following:

- Communications capability on 26 gauge wire pairs up to about 1000 feet, longer on larger gauges.
- A continuity test.

When Talk Battery is active, the LCD displays **LINE = SHORTED** if the test set is connected to a short circuit of 0 Ω to about 100 Ω .

To enable Talk Battery:

- 1 Connect the test set to a dry pair.
- 2 Set the slide switch to the Talk (T) position.
- 3 Press the down arrow when the message **LOW VOLT LOCKOUT, DOWN ARROW FOR TALK BATTERY** appears.

Note

The Talk Battery function drains the 9 V battery more quickly than other TS25D Test Set functions.

Caller ID/Call Waiting ID

The TS25D Test Set will detect and display both on-hook and off-hook caller ID messages. This is useful for verifying that a customer's Caller ID service is working properly. Caller ID (CID) messages are received when the receiving telephone is on-hook. Call Waiting ID (CIDCW) messages are received when the receiving telephone has already established a call to a second party and a third party places a call to your line.

To perform Caller ID detection:

- 1 Connect the test set to Tip and Ring of the customer's phone line. Either remove the customer's phone from the line or leave it on-hook.
- 2 Set the slide switch to the Monitor (**M**) position. If there is another line in the building, call from that line to the line the test set is connected to, or arrange for someone to call the line the test set is connected to. When the call comes in, you will hear the first ring, and then the received Caller ID message will be displayed on the test set's LCD.

To perform Call Waiting ID:

- 1 Connect the test set to Tip and Ring of the customer's phone line. Either remove the customer's phone from the line or leave it on-hook.
- 2 Set the slide switch to the Talk (**T**) position and establish a voice call to a second party. If there is another line in the building, call from that line to the line the test set is connected to, or arrange for someone to call the line the test set is connected to. When the call comes in, you will hear the Call Waiting Alert tone. This will be followed by the CAS tone and the Caller ID message. When the Caller ID message is received by the test set it will be displayed on the LCD.
- 3 If the received Caller ID message has errors, the test set will display **LINE ERROR**.

Toner

The Toner function is useful when tracing the routing of a pair of wires. When the Toner is activated, the TS25D Test Set generates a tone onto the wire pair the test set is connected to. The routing of the wire pair can then be traced by using an inductive Tone Probe to pick up the tone.

To use the Toner:

- 1 Connect the test set to the pair of wires you want to trace.
- 2 Set the slide switch to the Monitor (**M**) position.
- 3 Press the **SEL** button once to activate the test set's menu.
- 4 Use the Down arrow key to scroll the cursor down to the **TONER** entry.
- 5 Press the **SEL** key. The Toner will be activated and the LCD will display **TONER ACTIVE**.

To turn off the Toner press the **BACK** key.

If you accidentally connect to a data line, when you try to turn on the Toner you will get a message **DATA DETECTED TONER NOT AVAILABLE**. Remove the test set from the line.

The Toner on the test set is intended for use on dry (un-powered) pairs of wire. Before turning on the Toner, verify that the wire pair you are connected to is not carrying DC voltage by checking the test set's voltmeter in the upper right corner of the LCD. The Toner is only available when the TS25D Test Set is in Monitor mode.

DTMF Detection

The TS25D Test Set allows the user to capture DTMF tones generated on a telephone line by telephones, fax machines, modems or any other DTMF generating device. This feature is useful when you suspect the customer's telephone equipment is not generating proper DTMF signals.

To detect DTMF tones:

- 1 Connect the test set to Tip and Ring of the line under test.
- 2 Switch the test set to Monitor (**M**) mode.
- 3 Put the customer's telephone in Tone Dialing mode and take it off-hook.
- 4 Dial a number on the customer's phone. The number dialed will be detected and displayed on the test set's LCD.
- 5 Verify that the number on the LCD is the same as the number you dialed.

The TS25D Test Set will detect and display the DTMF tones for 0-9, *, #, A-D.

To clear the LCD screen, switch the test set off, and then back to Monitor mode. DTMF detection is only available when the TS25D Test Set is in Monitor mode.

Call and Dialing Functions

Note

Remove the protective film that covers the LCD display before using your test set.

Originating a Call

To originate a call:

- 1 Clip the test set to Tip and Ring of a powered subscriber loop.
- 2 Switch the test set to Monitor (**M**) mode and listen to the line to verify it is idle.
- 3 If not idle, disconnect the test set from the line.

- 4 If the line appears to be idle, set the slide switch to the Talk (**T**) position.
- 5 If no data is detected, the test set will go off hook.
- 6 If high-speed data is detected, the test set will not go off hook (will lockout) and will display **DATA DETECTED, DOWN ARROW TO OVERRIDE**, indicating the presence of data. Try another line or you can override the data lockout (see Data Lockout Override).
- 7 The numeric keypad, **LNR** key, or memory dialing may be used to dial a number for originating a call.

To disconnect a call, switch the test set off, or to monitor, or remove the clip leads from the line.

Answering a Call

To answer an incoming call:

- 1 Place the test set in Monitor mode to respond to incoming ringing signals.
- 2 If a ringing signal is received, set the slide switch to the Talk (**T**) position. The test set automatically tests for high-speed data on the line.
- 3 If no data is detected, the test set will go off hook.
- 4 If data is detected, test set will lock out and display the message **DATA DETECTED, DOWN ARROW TO OVERRIDE**.
- 5 To go off hook with data present you can override the data lockout (see Data Lockout Override).

Disconnecting a Call

To disconnect a call, switch the test set off, or to Monitor, or remove the clip leads from the line.

Last Number Redial

If a call is not successful and you wish to redial the same number, do the following:

- 1 Switch the test set off, then set the slide switch to the Talk (T) position.
- 2 After the test set goes off-hook press the **LNR** key. The last number dialed will be automatically redialed.

The last number redial function is available in either the Pulse or Tone Mode. The method of dialing is not stored with the number. The redial memory has a 23-digit capacity.

In Tone Dialing mode, the dialing keys that are permitted to be stored in LNR memory include 1,2,3,4,5,6, 7,8,9,0,*, and #. If the asterisk (*) and pound (#) keys are pressed in Pulse mode they will be ignored.

Memory Dialing

The TS25D Test Set allows the user to dial pre-programmed numbers in either Tone or Pulse mode. If dialing in Pulse mode and the stored number contains an asterisk (*) or pound (#) symbol, the digits will be ignored.

To activate Memory Dialing:

- 1 Connect the test set to a working telephone line and go off-hook by setting the slide switch to the Talk (T) position.
- 2 Press the **SEL** key. The Main menu is displayed.
- 3 At the Main menu, highlight **CALL PHONEBOOK** with the arrow keys, then press the **SEL** key. The list of phonebook entries is displayed. Pressing the arrow keys lets you scroll through all locations (0 through 9). The small number in the upper right of the LCD tells you which memory location you have selected.
- 4 Select the desired phonebook entry with the arrow keys, then press **SEL** key, or enter a number (0 through 9) on the keypad. The number is automatically dialed.

Speed Dialing (TS25D CO)

With the TS25D CO Test Set, you can dial numbers from memory as described above, or you can use the speed dialing feature, as follows:

- 1 Connect the TS25D CO Test Set to the telephone line.
- 2 Set the slide switch to the Talk (T) position, and listen for a dial tone.
- 3 Once you hear dial tone, press the **BACK** key followed by the number of the memory location (0 through 9) containing the telephone number you want to dial.

The telephone number in the selected memory location will be automatically dialed.

Memory Programming

Each memory location will store a phone number up to 23 digits in length. If you enter more than 23 digits only the first 23 will be remembered.

To store a new phone number:

- 1 Set the slide switch to the Talk (T) or Monitor (M) position.
- 2 Press the **SEL** key.
- 3 When the Main menu is displayed, highlight **EDIT PHONEBOOK** with the arrow keys, then press the **SEL** key. The list of phonebook entries is displayed. When you scroll through the entries, the number in the upper right of the screen indicates which one of the 10 memory locations you have selected. If you have no phonebook entries or if you are viewing this screen for the first time, it will be blank.
- 4 Select an empty memory location (0 through 9) with the arrow keys then press the **SEL** key, or use the number keys. A list of phonebook editing options appears.
- 5 Highlight **1 - EDIT NAME** and press the **SEL** key.

-continued-

6 The screen will change to **NAME**. Enter the name you want to assign to this Phonebook entry using the test set's keypad. Example: The **2** key gives you four possible characters: **A**, **B**, **C**, and **2**. If you press the **2** key once, the letter **A** is entered at the cursor's location. If you rapidly press the **2** key three times, the letter **C** is entered. If you rapidly press the **2** key four times, the number **2** is entered. After entering the desired character, wait a moment for the cursor to move one space to the right then enter the next character. Enter the remaining characters in the same manner. The asterisk key (*****) provides a space on the first press and an asterisk on the second press. The **1** key provides **&**, dash (**-**), forward slash (**/**), quote (**'**), period (**.**), or **1** depending on how many times you press the key. Use the Up arrow to erase characters. In this case, the Up arrow moves the cursor to the left.

7 After the entry is complete, press the **SEL** key to save the entry and return to the list of editing options.

8 Highlight **2 - EDIT NUMBER** and press the **SEL** key or press the **2** key.

9 The screen will change to **NUMBER**. Enter the phone number using the test set's keypad. This time pressing a dialing key will cause the number on the key to be entered. Use the Up arrow to erase characters. In this case, the Up arrow moves the cursor to the left.

On the **Number** screen, the **FLSH** key changes its normal meaning and becomes the **PAUSE** key. As you enter numbers into memory, if you press the **FLSH** key, a pause is entered at the cursor location. A comma is used to represent a pause. Pauses are used to put time delays into a string of numbers. The default pause duration is 4 seconds.

10 After the entry is complete, press the **SEL** key to save the entry and return to the list of editing options.

11 Press the **BACK** key twice to return to the Main menu, or press it three times to return to the main operating screen.

To edit an existing stored number:

1 Switch the test set to Talk (**T**) or Monitor (**M**) mode.

2 Press the **SEL** key.

3 When the Main menu is displayed, highlight **EDIT PHONEBOOK** with the arrow keys, then press the **SEL** key. The list of phonebook entries is

displayed. When you scroll through the entries, the number in the upper right of the screen indicates which one of the 10 memory locations you have selected. Pressing the arrow keys lets you scroll through all locations (0 through 9).

4 Move the cursor to the memory location you wish to edit and press the **SEL** key.

5 If you want to edit the name in the phonebook, highlight **1 - EDIT NAME** and press the **SEL** key.

6 The screen displays **NAME** and the text entry previously stored in this location. Modify the text using the Up arrow to erase text and the test set's keypad to enter new text. Example: The **2** key gives you four possible characters: **A**, **B**, **C**, and **2**. If you press the **2** key once, the letter **A** is entered at the cursor's location. If you rapidly press the **2** key three times, the letter **C** is entered. If you rapidly press the **2** key four times, the number **2** is entered.

After entering the desired character, wait a moment for the cursor to move one space to the right then enter the next character. Enter the remaining characters in the same manner. The asterisk key (*****) provides a space on the first press and an asterisk on the second press. The **1** key provides **&**, dash (**-**), forward slash (**/**), quote (**'**), period (**.**), or **1** depending on how many times you press the key.

Use the Up arrow to erase characters. In this case, the Up arrow moves the cursor to the left.

7 After the entry is complete, press the **SEL** key to save the entry and return to the list of editing options.

- 8 If you want to edit the number, highlight **2 - EDIT NUMBER** and press the **SEL** key.
- 9 The screen will change to **NUMBER** and display this memory location's existing phone number. Modify the number using the Up arrow to erase numbers and the test set's keypad to enter new numbers. In this screen, pressing a number key enters the number.

On the **Number** screen, the **FLSH** key changes its normal meaning and becomes the **PAUSE** key. As you enter numbers into memory, if you press the **FLSH** key, a pause is entered at the cursor location. A comma is used to represent a pause. Pauses are used to put time delays into a string of numbers. The default pause duration is 4 seconds.
- 10 After the entry is complete, press the **SEL** key to save the entry and return to the list of editing options.
- 11 Pressing the **BACK** key three times will take you back up through the menu selections to the main operating screen.

The Edit function will timeout after 15 seconds of inactivity.

To delete a phonebook number:

- 1 Move the cursor to the desired memory location, using the arrow keys, then press the **SEL** key to select.
- 2 Move cursor to **DELETE ENTRY** using the arrow keys and press the **SEL** key, or enter **3** for **DELETE ENTRY** on the keypad.
- 3 Press the **SEL** key to delete the entry and exit from the field.
- 4 Press the **BACK** key to return to the Main menu.

The Delete function will timeout after 15 seconds of inactivity.

Call List

The TS25D Test Set retains the last 3 outgoing and last 3 incoming phone numbers in its Call List. Incoming

numbers are recorded when Caller ID messages are received. Outgoing numbers are recorded when you dial a number. The most recently received number is put on top of the list. The Call List is available for viewing when the test set is on-hook. You can view and dial from the Call List when the test set is off-hook. To use the Call List:

- 1 Set the slide switch to the Talk (**T**) position.
- 2 Press the **SEL** key. The Main menu is displayed.
- 3 Highlight the **CALL LIST** option with the arrow keys, then press the **SEL** key.
- 4 Highlight **INCOMING** or **OUTGOING** with the arrow keys, then press the **SEL** key, or press either **1** for **INCOMING** or **2** for **OUTGOING**.
- 5 Once the incoming or outgoing list is displayed, you can highlight the desired number with the arrow keys. Each list is limited to three entries.
- 6 If the test set is off-hook, press the **SEL** key to dial the selected entry.

Configuring the Test Set

This section tells you how to use the menus to configure the test set.

Settings Screen

To access the Settings screen:

- 1 Set the slide switch to the Talk (**T**) or Monitor (**M**) position.
- 2 Press the **SEL** key.
- 3 At the Main menu, highlight **SETTINGS** with the arrow keys and press the **SEL** key. You will see a sub-menu with the following three selections: **TONE/PULSE, TIMING** and **SYSTEM CONFIGURATION**. These menu items provide access to the selections for configuring the test set.

Tone/Pulse Dialing

To set Tone or Pulse dialing:

- 1 At the Main menu, highlight **SETTINGS** with the arrow keys, then press the **SEL** key.
- 2 Highlight **Tone/Pulse** with the arrow keys, then press the **SEL** key, or press **1** on the keypad.
- 3 Press either **1** for **TONE** or **2** for **PULSE**. The Tone or Pulse icon is displayed at the top of the screen (see Figure 2).

Timing

Use the Timing option to set the Pause duration and the Flash duration.

Pause Duration

To set the Pause duration:

- 1 Set the slide switch to the Talk (**T**) or Monitor (**M**) position.
- 2 From the Settings screen, highlight **TIMING** with the arrow keys, then press the **SEL** key, or press **2** on the keypad.
- 3 Press **1 - PAUSE DURATION**.
- 4 Highlight the desired pause seconds with the arrow keys, then press the **SEL** key, or press one of the following keys on the keypad:
 - 1 - 3 seconds
 - 2 - 4 seconds
 - 3 - 5 seconds

The default pause length is 4 seconds.

Flash Duration

To set the hook flash duration:

- 1 Set the slide switch to the Talk (**T**) or Monitor (**M**) position.
- 2 From the Settings screen, highlight **TIMING** with the arrow keys, then press the **SEL** key, or press **2** on the keypad.

- 3 Press **2 - FLASH DURATION**.
- 4 Highlight the desired flash seconds with the arrow keys, then press the **SEL** key, or press one of the following keys on the keypad:
 - 1 - 400 ms
 - 2 - 600 ms
 - 3 - 800 ms

The default hook flash duration is 600 ms.

One flash is performed for each press of the **FLSH** key. Holding the **FLSH** key down does not repeatedly flash the switch hook.

System Timeout

The System Timeout function turns off the tester after a selected period of inactivity. After the test set turns off, you can turn it on by switching the Talk/Off/Monitor switch to off then to either Talk or Monitor.

To set the system timeout period:

- 1 Set the slide switch to the Talk (**T**) or Monitor (**M**) position.
- 2 From the Settings screen, highlight **SYSTEM CONFIGURATION** with the arrow keys, then press the **SEL** key, or press **3** on the keypad.
- 3 Press **1 - SYSTEM TIMEOUT**.
- 4 Highlight the desired time with the arrow keys, then press the **SEL** key, or press one of the following keys on the keypad:

TS25D

- 1 - 30 minutes
- 2 - 60 minutes (default)
- 3 - Never

TS25D CO

- 1 - 5 minutes (default)
- 2 - 60 minutes
- 3 - Never

Speaker Timeout

The test set's speaker uses more battery power than most other functions. To extend battery life, the Speaker Timeout function turns off the speaker after a selected period of inactivity.

After the speaker turns off, you can turn it back on by pressing the **SPKR** button.

To set the speaker timeout period:

- 1 Set the slide switch to the Talk (**T**) or Monitor (**M**) position.
- 2 From the Settings screen, highlight **SYSTEM CONFIG** with the arrow keys, then press the **SEL** key, or press **3** on the keypad.
- 3 Press **2 - SPKR TIMEOUT**.
- 4 Highlight the desired time with the arrow keys, then press the **SEL** key, or press one of the following keys on the keypad:
 - 1 - 2 minutes (TS25D CO default)
 - 2 - 5 minutes (TS25D default)
 - 3 - 10 minutes

Data Lockout

The Data Lockout function is may be turned on or off. The default setting is **ON**.

- 1 Set the slide switch to the Talk (**T**) or Monitor (**M**) position.
- 2 From the Settings screen, highlight **SYSTEM CONFIGURATION** with the arrow keys, then press the **SEL** key, or press **3** on the keypad.
- 3 Press **3 - DATA LOCKOUT**.
- 4 Highlight the desired setting with the arrow keys, then press the **SEL** key, or press **1** for **ON** or **2** for **OFF**.

When data lockout is set to **OFF**, the test set will still detect data and will display **DATA DETECTED**, but it will not lockout.

Firmware Version

To view current Firmware version:

- 1 Set the slide switch to the Talk (**T**) or Monitor (**M**) position.
- 2 From the Settings screen, highlight **SYSTEM CONFIG** with arrow keys, then press the **SEL** key, or press **3** on the keypad.
- 3 Use the Down arrow key to scroll down to **VERSION**. Press **4** for **VERSION**. The version of software is displayed on the screen.
- 4 Use the **BACK** key to return to the previous menu.

Factory Settings

You can reset the TS25D Test Set to its original factory settings. If you do this, the factory settings will be restored and the entries in your phonebook and the phone numbers in the Call Lists will be deleted. If you don't want to erase the phonebook entries, don't reset to defaults.

To reset the test set to its factory default settings:

- 1 Set the slide switch to the Talk (**T**) or Monitor (**M**) position.
- 2 Press the **SEL** key.
- 3 Select the **SETTINGS** screen and highlight **SYSTEM CONFIGURATION** with the arrow keys and press the **SEL** key.
- 4 Use the Down arrow key to scroll down to **FACTORY RESET** and then press the **SEL** key.
- 5 The screen will display **PRESS LNR TO RESTORE FACTORY SETTINGS**. If you are sure you want to restore the factory default settings then press the **LNR** key. If you do not want to restore the factory settings, press the **BACK** key.

Maintenance

⚠ Warning ⚠

To avoid electric shock, do not perform any servicing other than that contained in the operating instructions unless you are qualified to do so.

Disconnect clips from any metallic connections before performing any maintenance.

⚠ Caution

Do not use CRC Cable Clean® or any similar chlorinated solvent on the test set. Doing so will damage the test set.

If moisture should get inside the test set, let the test set dry at normal room temperature for 24 hours. DO NOT HEAT THE TEST SET. Moisture can provide a leakage path that may conduct hazardous voltages to you. DO NOT USE the test set if wet.

Keypad Care

Daily use of your test set results in various liquids, dirt, and other foreign material building up in your keypad. The keypad may be cleaned by using a soft toothbrush with soap and water. Do not use a petroleum-based or chlorinated cleaning agent as it will harm the keypad. Let the test set dry before use.

Replacing the Battery

⚠ Caution

Handling batteries should be done with care. Do not allow the terminals to be shorted together. Dispose of battery properly to ensure contacts cannot short. Disposal may be restricted by local laws.

To replace the battery (see Figure 3):

- 1 Turn the test set off.
- 2 Place the test set on a work surface, face down. The work surface should be non-abrasive.

- 3 Using a Phillips screwdriver, remove the single cover screw attaching the battery door cover to the back of the test set.
- 4 Remove the battery door cover and the old 9 V battery from the test set. Properly discard the battery.
- 5 Insert a new 9 V battery. Make sure the polarity is correct.

Note

Do not over tighten screw. Over tightening will strip the plastic.

- 6 Replace the test set's battery door cover on the test set and secure with single cover screw. Do not over tighten the screw.

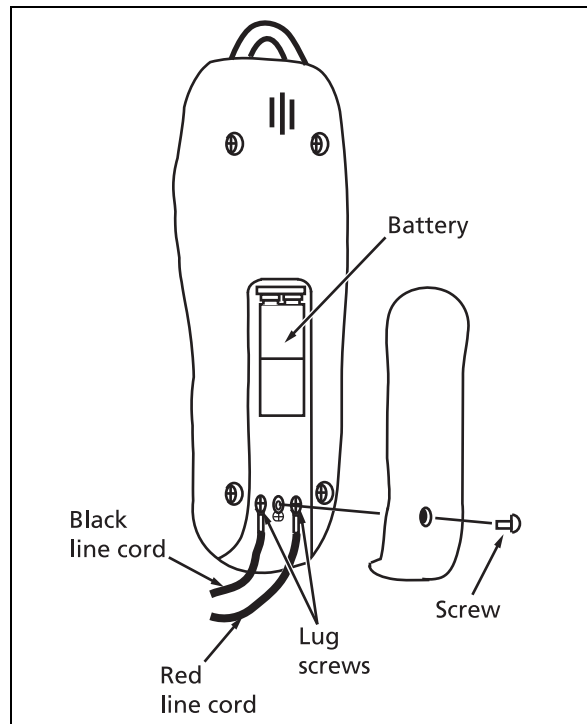
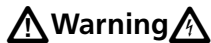

Figure 3. Battery and Line Cord Replacement

Replacing the Line Cord

See Figure 3.

A worn out or damaged line cord can be replaced by the user. To obtain a replacement line cord contact your local distributor or Fluke Networks.



Disconnect from telephone network when replacing line cord.

To replace the line cord (see Figure 3):

- 1 Turn the test set off.
- 2 Place the test set on a protected work surface, face down.
- 3 Using a Phillips screwdriver, remove the single cover screw attaching the battery door cover to the back of the test set.
- 4 Remove the battery door cover.
- 5 Loosen the two screws that hold the line cords to the PCB.
- 6 Using needle nose pliers or one of the line cord clips, remove the two screws and washers from the line cord connectors.
- 7 Position the screw lugs of a new line cord on the PCB. Make sure the crimp barrel offset side of the screw lugs is up (see Figure 4) and that the line cord screw lugs are flush against the PCB.

Note

Do not over tighten screw. Over tightening will strip the plastic.

- 8 Fasten the red wire lug to the PCB (Ring) with screw and washer.
- 9 Fasten the black wire lug to the PCB (Tip) with screw and washer.

Note

It is important to install the red and black wires as shown in Figure 3 so the polarity icon will work correctly.

- 10 Push both line cord wires down into the notch in the case.
- 11 Replace the test set's battery door cover on the test set and secure with single cover screw. Do not over tighten the screw — doing so could damage the test set.

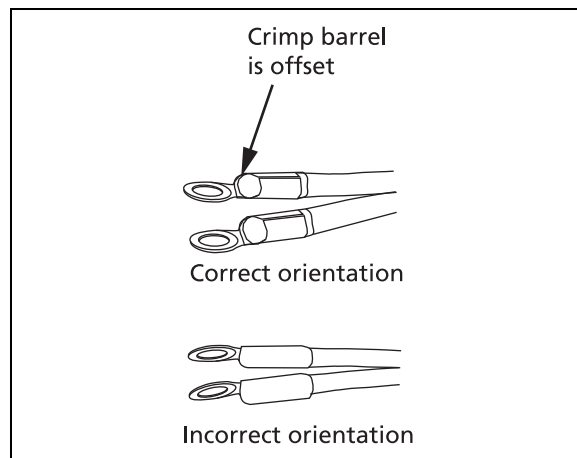

Figure 4. Orientation of Line Cord Screw Lugs

cac04.eps

Specifications

Electrical	
Return Loss	>14 dB (ref 600 Ω)
DC Resistance	
Off-Hook	150 Ω nominal
On-Hook	>1 MΩ
AC Impedance	
Off-Hook	600 Ω nominal; 300 Hz to 3400 Hz
On-Hook	>120 kΩ; 300 Hz to 3400 Hz
Rotary Dial Output	
Pulsing Rate	10 pps ±1 pps
Break/Make Ratio	60/40
Interdigit Interval	>300 ms
Resistance During Break	>100 kΩ
DTMF Output	
Tone Frequency Error	±1.5 % maximum
Tone Level	-1 dBm combined (typical)
High versus Low Tone Difference	2 dB ± 2 dB
Memory Dialing	
Memory Capacity	10 speed dial memories plus one last number redial memory
Digit Capacity	23 digits per memory
Pause Duration	User programmable Default: 4 seconds
Hook Flash Duration	User programmable Default: 600 ms
Automatic Speaker Shut Off Duration	User programmable TS25D default: 5 minutes TS25D CO default: 2 minutes

Battery	9 V alkaline battery
Physical	
Measurement	7.8 in x 2.7 in x 1.6 in (20 cm x 6.8 cm x 4 cm)
Weight	10 ounces (284 g)
Environmental	
Temperature Range	
Operating	32°F to 122 °F (0 °C to 50 °C)
Storage	-40 °F to 150 °F (-40 °C to 65 °C)
Altitude	Up to 10,000 ft (3,000 m)
Relative Humidity	5 % to 95 %
Certifications and Compliance	
Safety: IEC 61010-1; Pollution Degree 2. 220 V maximum	
EMC: IEC 61326-1	
<i>Notes</i>	
<i>Specifications subject to change without notice.</i>	
<i>This product has been safety certified for indoor use only.</i>	