

FLUKE®

Hart Scientific®

1502A

*Thermometer Readout
User's Guide*

Limited Warranty & Limitation of Liability

Each product from Fluke Corporation, Hart Scientific Division ("Hart") is warranted to be free from defects in material and workmanship under normal use and service. The warranty period is three years for the Thermometer Readout. The warranty period begins on the date of the shipment. Parts, product repairs, and services are warranted for 90 days. The warranty extends only to the original buyer or end-user customer of a Hart authorized reseller, and does not apply to fuses, disposable batteries or to any other product which, in Hart's opinion, has been misused, altered, neglected, or damaged by accident or abnormal conditions of operation or handling. Hart warrants that software will operate substantially in accordance with its functional specifications for 90 days and that it has been properly recorded on non-defective media. Hart does not warrant that software will be error free or operate without interruption. Hart does not warrant calibrations on the Thermometer Readout.

Hart authorized resellers shall extend this warranty on new and unused products to end-user customers only but have no authority to extend a greater or different warranty on behalf of Hart. Warranty support is available if product is purchased through a Hart authorized sales outlet or Buyer has paid the applicable international price. Hart reserves the right to invoice Buyer for importation costs of repairs/replacement parts when product purchased in one country is submitted for repair in another country.

Hart's warranty obligation is limited, at Hart's option, to refund of the purchase price, free of charge repair, or replacement of a defective product which is returned to a Hart authorized service center within the warranty period.

To obtain warranty service, contact your nearest Hart authorized service center or send the product, with a description of the difficulty, postage, and insurance prepaid (FOB Destination), to the nearest Hart authorized service center. Hart assumes no risk for damage in transit. Following warranty repair, the product will be returned to Buyer, transportation prepaid (FOB Destination). If Hart determines that the failure was caused by misuse, alteration, accident or abnormal condition or operation or handling, Hart will provide an estimate or repair costs and obtain authorization before commencing the work. Following repair, the product will be returned to the Buyer transportation prepaid and the Buyer will be billed for the repair and return transportation charges (FOB Shipping Point).

THIS WARRANTY IS BUYER'S SOLE AND EXCLUSIVE REMEDY AND IS IN LIEU OF ALL OTHER WARRANTIES, EXPRESS OR IMPLIED, INCLUDING BUT NOT LIMITED TO ANY IMPLIED WARRANTY OF MERCHANTABILITY OR FITNESS FOR A PARTICULAR PURPOSE. HART SHALL NOT BE LIABLE FOR ANY SPECIAL, INDIRECT, INCIDENTAL OR CONSEQUENTIAL DAMAGES OR LOSSES, INCLUDING LOSS OF DATA, WHETHER ARISING FROM BREACH OF WARRANTY OR BASED ON CONTRACT, TORT, RELIANCE OR ANY OTHER THEORY.

Since some countries or states do not allow limitation of the term of an implied warranty, or exclusion or limitation of incidental or consequential damages, the limitations and exclusions of this warranty may not apply to every buyer. If any provision of this Warranty is held invalid or unenforceable by a court of competent jurisdiction, such holding will not affect the validity or enforceability of any other provision.

Fluke Corporation, Hart Scientific Division

799 E. Utah Valley Drive • American Fork, UT 84003-9775 • USA

Phone: +1.801.763.1600 • Telefax: +1.801.763.1010

E-mail: support@hartscientific.com

www.hartscientific.com

Subject to change without notice. • Copyright © 2005 • Printed in USA

Table of Contents

1	Before You Start	1
1.1	Symbols Used	1
1.2	Safety Information	2
1.2.1	Warnings	2
1.2.2	Cautions	3
1.3	Authorized Service Centers	4
2	Introduction	7
3	Specifications and Environmental Conditions	9
3.1	Specifications	9
3.2	Environmental Conditions	10
4	Quick Start	11
4.1	Unpacking	11
4.2	Power	11
4.3	Connecting the Probe	11
5	Parts and Controls	13
5.1	Front Panel Buttons	13
5.2	Rear Panel	14
6	General Operation	15
6.1	Selecting Units	15
6.2	Parameter Menus	15
6.3	Menu Lockout	15
6.4	Selecting the Probe Characterization	17
6.4.1	Setting the Probe Characterization Type	17
6.4.2	Setting the Characterization Coefficients	17
6.4.3	ITS-90 PRT and Coefficients	18
6.4.4	Callendar-Van Dusen (RTD) Conversion	20
6.4.5	IPTS-68 Conversion	21
6.4.5.1	Setting the Characterization Coefficients	21
6.4.5.2	Testing the Coefficients	21
6.5	Filtering	22
6.6	Setting the Current	22
6.7	Power Saver	22

7	Digital Communications Interface	23
7.1	Serial Interface	23
7.1.1	Setting the Baud Rate	23
7.1.2	Automatic Transmission of Measurements	24
7.1.3	Time Stamp and System Clock	24
7.1.4	Duplex Mode and Linefeed	25
7.2	GPIB Interface	25
7.2.1	Setting the Address	26
7.2.2	Setting the Termination Character	26
7.2.3	Time Stamp	26
7.3	Remote Commands	26
7.3.1	Measurement Commands	26
7.3.1.1	Reading Temperature	28
7.3.1.2	Automatically Transmitting Measurements	29
7.3.1.3	Selecting the Unit of Measurement	29
7.3.1.4	Enabling the Time Stamp	29
7.3.1.5	Setting the Clock	29
7.3.2	Probe Characterization Commands	29
7.3.2.1	Selecting the Characterization	30
7.3.2.2	Testing the Characterization	30
7.3.3	Sample Commands	30
7.3.3.1	Setting the Filter	31
7.3.3.2	Setting the Probe Current	31
7.3.3.3	Setting the Power Saver	31
7.3.4	Communication Commands	31
7.3.4.1	Setting the Duplex Mode	31
7.3.4.2	Setting the Linefeed Option	31
7.3.5	Calibration Commands	32
7.3.5.1	Entering the Password	32
7.3.5.2	Setting the Menu Lockout	32
7.3.5.3	Setting the Calibration Coefficients	32
7.3.5.4	Setting the Serial Number	32
7.3.6	Other Commands	32
7.3.6.1	Instrument Identification	32
7.3.6.2	Reading a List of Commands	33
8	Calibration Procedure	35
8.1	Accessing the Calibration Parameters	35
8.2	Calibration Procedure	36
9	Maintenance	37
10	Troubleshooting.	39
10.1	CE Comments	40
10.1.1	EMC Directive	40
10.1.1.1	Immunity Testing	41
10.1.1.2	Emission Testing	41
10.1.2	Low Voltage Directive (Safety)	41

Figures

Figure 1	Connecting a four-wire probe	12
Figure 2	1502A Front Panel	13
Figure 3	1502A Back Panel	14
Figure 4	Parameter Menu Structure	16
Figure 5	Serial Cable Wiring	23

Tables

Table 1	International Electrical Symbols	1
Table 2	Matching Certificate Values to 1502A ITS-90 Coefficients	18
Table 3	Setting Coefficients Rtpw, a8, b8, a4, and b4	19
Table 4	Setting Coefficients Rtpw, a5, and b5	19
Table 5	Setting Coefficients R(273.16), a6, b6, c6, and d	20
Table 6	Command List	27
Table 6	Command List Continued	28













1 Before You Start





1.1 Symbols Used

Table 1 lists the symbols that may be used on the instrument or in this manual

Table 1 International Electrical Symbols

and the meaning of each symbol.

Symbol	Description
	AC (Alternating Current)
	AC-DC
	Battery
	Complies with European Union Directives
	DC (Direct Current)
	Double Insulated
	Electric Shock
	Fuse
	PE Ground
	Hot Surface (Burn Hazard)
	Read the User's Manual (Important Information)
	Off

Symbol	Description
	On
	Canadian Standards Association
CAT II	OVERVOLTAGE (Installation) CATEGORY II, Pollution Degree 2 per IEC1010-1 refers to the level of Impulse Withstand Voltage protection provided. Equipment of OVERVOLTAGE CATEGORY II is energy-consuming equipment to be supplied from the fixed installation. Examples include household, office, and laboratory appliances.
	C-TIC Australian EMC mark
	The European Waste Electrical and Electronic Equipment (WEEE) Directive (2002/96/EC) mark.

1.2 Safety Information

Use this instrument only as specified in this manual. Otherwise, the protection provided by the instrument may be impaired. Refer to the safety information in Sections 1.2.1 and 1.2.2.

The following definitions apply to the terms “Warning” and “Caution”.

- “Warning” identifies conditions and actions that may pose hazards to the user.
- “Caution” identifies conditions and actions that may damage the instrument being used.

1.2.1 Warnings

To avoid possible electric shock or personal injury, follow these guidelines.

DO NOT operate this unit without a properly grounded, properly polarized power cord.

DO NOT connect this unit to a non-grounded, non-polarized outlet.

DO NOT use this unit for any application other than calibration work.

DO NOT use this unit in environments other than those listed in the user's guide.

DO NOT use this instrument in combination with any probe to measure the temperature or resistance of any device where the probe might come in contact with a conductor that is electrically energized. Severe electric shock, personal injury, or death may occur.

If this equipment is used in a manner not specified by the manufacturer, the protection provided by the equipment may be impaired.

Before initial use, or after transport, or after storage in humid or semi-humid environments, or anytime the instrument has not been energized for more than 10 days, the instrument needs to be energized for a "dry-out" period of 2 hours before it can be assumed to meet all of the safety requirements of the IEC 1010-1. If the product is wet or has been in a wet environment, take necessary measures to remove moisture prior to applying power such as storage in a low humidity temperature chamber operating at 50°C for 4 hours or more.

Follow all safety guidelines listed in this user's guide.

Calibration Equipment should only be used by Trained Personnel.

To avoid possible burn hazards, follow these guidelines.

This instrument can measure extreme temperatures. Precautions must be taken to prevent personal injury or damage to objects. Probes may be extremely hot or cold. Cautiously handle probes to prevent personal injury. Carefully place probes on a heat/cold resistant surface or rack until they reach room temperature.

1.2.2 **Cautions**

To avoid possible damage to the instrument, follow these guidelines.

DO NOT change the values of the calibration constants from the factory set values unless you are recalibrating the instrument. The correct setting of these parameters is important to the safety and proper operation of the instrument.

Allow sufficient air circulation by leaving at least 3 inches of space between the thermometer and nearby objects.

For CE compliance and for performance, use only the AC adapter shipped with the instrument. If the AC adapter needs to be replaced, contact an Authorized Service Center.

This instrument and thermometer probes are sensitive and can be easily damaged. Always handle these devices with care. **DO NOT** allow them to be dropped, struck, stressed, or overheated.

Probes are fragile instruments which can be damaged by mechanical shock, over-heating, and absorption of moisture or fluids in the wires or hub. Damage may not be visibly apparent but nevertheless can cause drift, instability, and loss of accuracy. Observe the following precautions:

DO NOT allow probes to be dropped, struck, bent, or stressed.

DO NOT overheat probes beyond their recommended temperature range.

DO NOT allow any part of the probe other than the sheath to be immersed in fluid.

DO NOT allow the probe hub or wires to be exposed to excessive temperatures.

Keep the probe wires clean and away from fluids.

1.3 Authorized Service Centers

Please contact one of the following authorized Service Centers to coordinate service on your Hart product:

Fluke Corporation, Hart Scientific Division

799 E. Utah Valley Drive
American Fork, UT 84003-9775
USA

Phone: +1.801.763.1600
Telefax: +1.801.763.1010
E-mail: support@hartscientific.com

Fluke Nederland B.V.

Customer Support Services
Science Park Eindhoven 5108
5692 EC Son
NETHERLANDS

Phone: +31-402-675300
Telefax: +31-402-675321
E-mail: ServiceDesk@fluke.nl

Fluke Int'l Corporation

Service Center - Instrimpex
Room 2301 Sciteck Tower
22 Jianguomenwai Dajie
Chao Yang District
Beijing 100004, PRC
CHINA

Phone: +86-10-6-512-3436
Telefax: +86-10-6-512-3437
E-mail: xingye.han@fluke.com.cn

Fluke South East Asia Pte Ltd.

Fluke ASEAN Regional Office
Service Center
60 Alexandra Terrace #03-16
The Comtech (Lobby D)
118502
SINGAPORE

Phone: +65 6799-5588

Telefax: +65 6799-5588

E-mail: antng@singa.fluke.com

When contacting these Service Centers for support, please have the following information available:

- Model Number
- Serial Number
- Voltage
- Complete description of the problem

2 Introduction

The 1502A is a low-cost high-accuracy digital thermometer readout designed to be used with 25 Ω and 100 Ω RTDs and SPRTs. Its unique combination of features makes it suitable for a wide variety of applications from laboratory measurement to industrial processes. Features of the 1502A include:

- Measures 25 Ω and 100 Ω RTDs and SPRTs
- Four-wire connection eliminates lead resistance effects
- Accuracy: 0.006 $^{\circ}$ C at 0 $^{\circ}$ C
- Resolution: 0.001 $^{\circ}$ C
- Fast one-second measurement cycle
- Adjustable digital filter
- Accepts ITS-90 characterization coefficients
- Also accepts Callendar-Van Dusen and IPTS-68 coefficients
- Adjustable excitation current
- Displays temperature in Celsius, Fahrenheit, or Kelvin or displays resistance in ohms
- Password protection of critical parameters
- Large, bright eight-digit LED display
- Serial RS-232 interface standard; IEEE-488 GPIB interface optional
- Detachable power cord
- Light weight, small and portable
- Sturdy, reliable construction

3 Specifications and Environmental Conditions

3.1 Specifications

Resistance Range	0Ω to 400Ω, auto-ranging
Resistance Accuracy, one year¹	0Ω to 20Ω: 0.0005Ω 20Ω to 400Ω: 0.0025% (25 ppm) of reading
Resistance Accuracy, short term^{1,2}	0Ω to 30Ω: 0.0005Ω 30Ω to 400Ω: 0.0015% (15 ppm) of reading
Temperature Range³	-200°C to 962°C (-328°F to 1764°F)
Temperature Accuracy^{1,3,4}	-100°C: 0.004°C 0°C: 0.006°C 100°C: 0.009°C 200°C: 0.012°C 300°C: 0.015°C 400°C: 0.018°C 500°C: 0.021°C 600°C: 0.024°C
Temperature Coefficient of Resistance¹	1 ppm/°C
Resistance Resolution	0Ω to 20Ω: 0.0001Ω 20Ω to 400Ω: 0.001Ω
Temperature Resolution	0.001°C
Probe	Nominal R(0.01°C): 10Ω to 100Ω RTD, PRT, or SPRT
Probe Connection	4-wire with shield, 5-pin DIN connector
Maximum acceptable lead resistance	100Ω
Probe Characterizations	ITS-90 sub-ranges 4, 6, 7, 8, 9, 10, and 11 IPTS-68: R_0 , α , δ , a_4 , and c_4 Callendar-Van Dusen: R_0 , α , δ , and β
Probe Excitation Current	0.5 and 1 mA, user selectable, 2Hz
Measurement Period	1 second
Digital Filter	Exponential, 0 to 60 seconds time constant (user-selectable)
Communications	RS-232 serial standard IEEE-488 (GPIB) optional, conforms to IEEE-488.1, capability AH1, SH1, T6, L4, DC1
Display	8-digit, 7-segment, yellow-green LED; 0.5 inch high characters
Clock accuracy, typical	0.01%
Operating Temperature Range	Full accuracy: 16°C to 30°C Absolute: 0°C to 55°C
AC power	115 VAC \pm 10%, 50/60 Hz, 10 W, nominal, 1 A maximum 230 VAC \pm 10%, 50/60 Hz, 10 W, 1 A, nominal (optional) Detachable power cord
Size	5.6 inches (14.3 cm) wide x 7.1 inches (18.1 cm) deep x 2.4 inches (6.1 cm) high

Weight	2.2 lb. (1.0 kg)
Safety	OVERVOLTAGE (Installation) CATEGORY II, Pollution Degree 2 per IEC 1010-1

¹Accuracy specifications apply within the recommended operating temperature range. Accuracy limits are increased by a factor of the temperature coefficient outside this range.

²Short-term accuracy includes nonlinearity and noise uncertainties. It does not include drift or calibration uncertainties.

³The temperature range may be limited by the sensor.

⁴Temperature accuracy is for the 1502A only using a 100 Ω PRT. It does not include probe uncertainty or probe characterization errors.

3.2 Environmental Conditions

Although the instrument has been designed for optimum durability and trouble-free operation, it must be handled with care. The instrument should not be operated in an excessively dusty or dirty environment. Maintenance and cleaning recommendations can be found in the Maintenance Section of this manual.

The instrument operates safely under the following conditions:

- Ambient temperature range: Absolute 0–55°C (32–131°F); [full accuracy 16–30°C (61–86°F)]
- Ambient relative humidity: maximum 80% for temperature < 31°C, decreasing linearly to 50% at 40°C
- Pressure: 75kPa–106kPa
- Mains voltage within $\pm 10\%$ of nominal
- Vibrations should be minimized
- Altitude less than 2,000 meters
- Indoor use only

4 Quick Start

This section briefly explains the basics of setting up and operating your 1502A thermometer readout.

4.1 Unpacking

Unpack the thermometer carefully and inspect it for any damage that may have occurred during shipment. If there is shipping damage, notify the carrier immediately.

Verify that the following components are present:

- 1502A Thermometer
- Extra Probe Connector
- Power Cord
- User's Guide
- Probe (optional—must be purchased separately)

4.2 Power

Your 1502A is configured for either 115 VAC ($\pm 10\%$) operation or 230 VAC ($\pm 10\%$) operation. Be careful to only connect the 1502A to a mains supply of the correct voltage. Otherwise, the instrument may be damaged. The required voltage is indicated on the back of the 1502A. Power requirements are listed in Section 3.1, Specifications. The IEC type power cord connects to the back of the 1502A. The cord must be plugged in to a grounded outlet. The power switch is located at the back of the 1502A.

When the 1502A is powered on, wait briefly while it initializes. It will then begin measuring and displaying temperature.

Because of the quality of the components used in the 1502A, it exhibits nearly negligible drift as it warms up. The warm-up drift is typically less than 5 ppm. Nevertheless, to ensure the best accuracy and stability, you may want to allow the 1502A to warm up for ten minutes before use.

Accurate measurement requires that the probe be connected properly to the input and the correct probe characterization set.

4.3 Connecting the Probe

The RTD or SPRT probe connects to the back of the 1502A using a five-pin DIN plug. Figure 1 shows how a four-wire probe is wired to the five-pin DIN connector. One pair of wires attaches to pins 1 and 2 and the other pair attaches

to pins 4 and 5. (Pins 1 and 5 source current and pins 2 and 4 sense the potential.) If a shield wire is present it should be connected to pin 3.

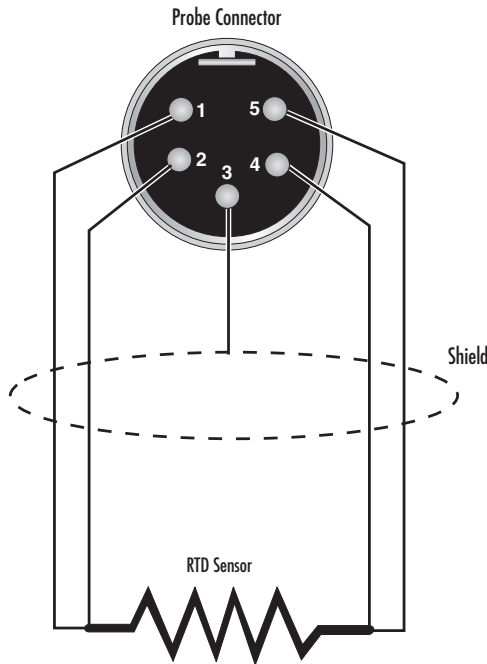

Figure 1 Connecting a four-wire probe

A two-wire probe can also be used with the 1502A. It is connected by attaching one wire to both pins 1 and 2 of the plug and the other wire to both pins 4 and 5. If a shield wire is present it should be connected to pin 3. Accuracy may be significantly degraded using a two-wire connection because of lead resistance.

5 Parts and Controls

5.1 Front Panel Buttons

See Figure 2.

The front panel buttons are used to select units of measurement, access operating parameters, and alter operating parameters. The function of each button is as follows:

C/Probe—This button selects units of degrees Celsius. In conjunction with the **Menu** button, it selects the probe parameter menu.

F/Sample—This button selects units of degrees Fahrenheit. In conjunction with the **Menu** button, it selects the sample parameter menu.

K/Comm—This button selects units of Kelvin. In conjunction with the **Menu** button, it selects the communication parameter menu.

Ω /Exit (Cal)—This button selects resistance in ohms. While editing a parameter, it cancels the immediate operation and skips to the next parameter. If the **Exit** button is pressed for more than one-half second the menu is exited. In conjunction with the **Menu** button, it selects the calibration parameter menu.

Menu/Enter—This button allows one of the unit/menu buttons to select a menu. When editing a parameter, it accepts the new value and skips to the next operation.

◀ and ▶ —When editing a numeric parameter, these buttons move between digits. The selected digit flashes.

▲ and ▼ —When editing a parameter, these buttons increase or decrease the value of the parameter or a selected digit.



Figure 2 1502A Front Panel

5.2 Rear Panel

See Figure 3.

Serial Port - The DB-9 connector is for interfacing the thermometer to a computer or terminal with serial RS-232 communications.

Probe Connector - At the rear of the thermometer is the probe connector. The probe must be connected for operation.

Power Switch - The power switch is located on the rear of the thermometer. The AC power switch turns the unit on and off.

AC Power - At the rear of the instrument is the removable power cord that plugs into a standard 115 VAC grounded socket. (230 VAC optional)

IEEE-488 Port (optional) - The GPIB connector is for interfacing the thermometer to a computer or terminal with IEEE-488 communications.

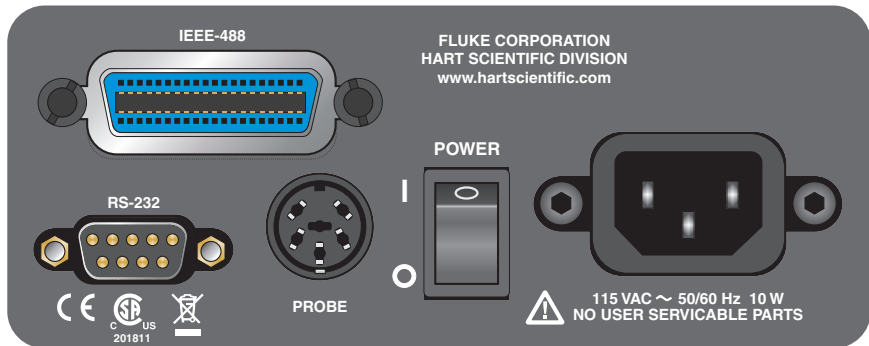

Figure 3 1502A Back Panel

6 General Operation

This section explains basic operation of the 1502A Thermometer.

6.1 Selecting Units

Temperature can be displayed in degrees Celsius (indicated with “C”), degrees Fahrenheit (indicated with “F”), or Kelvin (indicated with “K” for absolute). The resistance of the sensor can also be displayed (indicated with “Ω” for ohms). Simply press the appropriate unit button, C, F, K, or Ω to select the units.

6.2 Parameter Menus

Except for unit selection, all functions and operating parameters are accessed and edited within the parameter menus. There are four menus: the **Probe** parameter menu, **Sample** parameter menu, **Comm** (communication) parameter menu, and **Cal** (calibration) parameter menu. The arrangement of parameters in the menus is shown in Figure 4 on page 16.

Menus are selected by pressing the **Menu/Enter** button followed by the appropriate menu selection button. The name of the menu will briefly appear on the display. For example, the **Probe** menu is selected by pressing the **Menu/Enter** button (“SELE” appears on the display) followed by the **C/Probe** button (“PROBE” appears). Selecting the **Cal** menu requires that you press the **Menu/Enter** button then press the **Ω/Exit** button and hold it down for at least one second.

The **Probe** menu contains parameters for selecting the probe characterization and setting the characterization coefficients. These parameters are explained in [Section 6.4](#). The **Sample** menu contains parameters for setting the filter and excitation current. These are explained in Sections 6.5 and 6.6. The **Comm** menu contains communication parameters such as the serial baud rate or IEEE-488 address. These are explained in Sections 7.1 and 7.2. The **Cal** menu contains the calibration parameters. These are explained in Section 8.1.

6.3 Menu Lockout

All menus can be locked out to prevent inadvertently changing parameters. By default, only the **Cal** menu is locked out. The lockout option is accessed in the **Cal** menu (see [Section 8.1](#) “Accessing the Calibration Parameters”).

If menus are locked out you must enter the correct password (“2051”) to gain access. After you select the menu (see the previous section) the display will show “PA= 0000” and allow you to change the number to the correct password. Use the ◀ and ▶ buttons to move between the password digits and the ▲ and ▼ buttons to increase or decrease the value of a digit. Press **Enter**

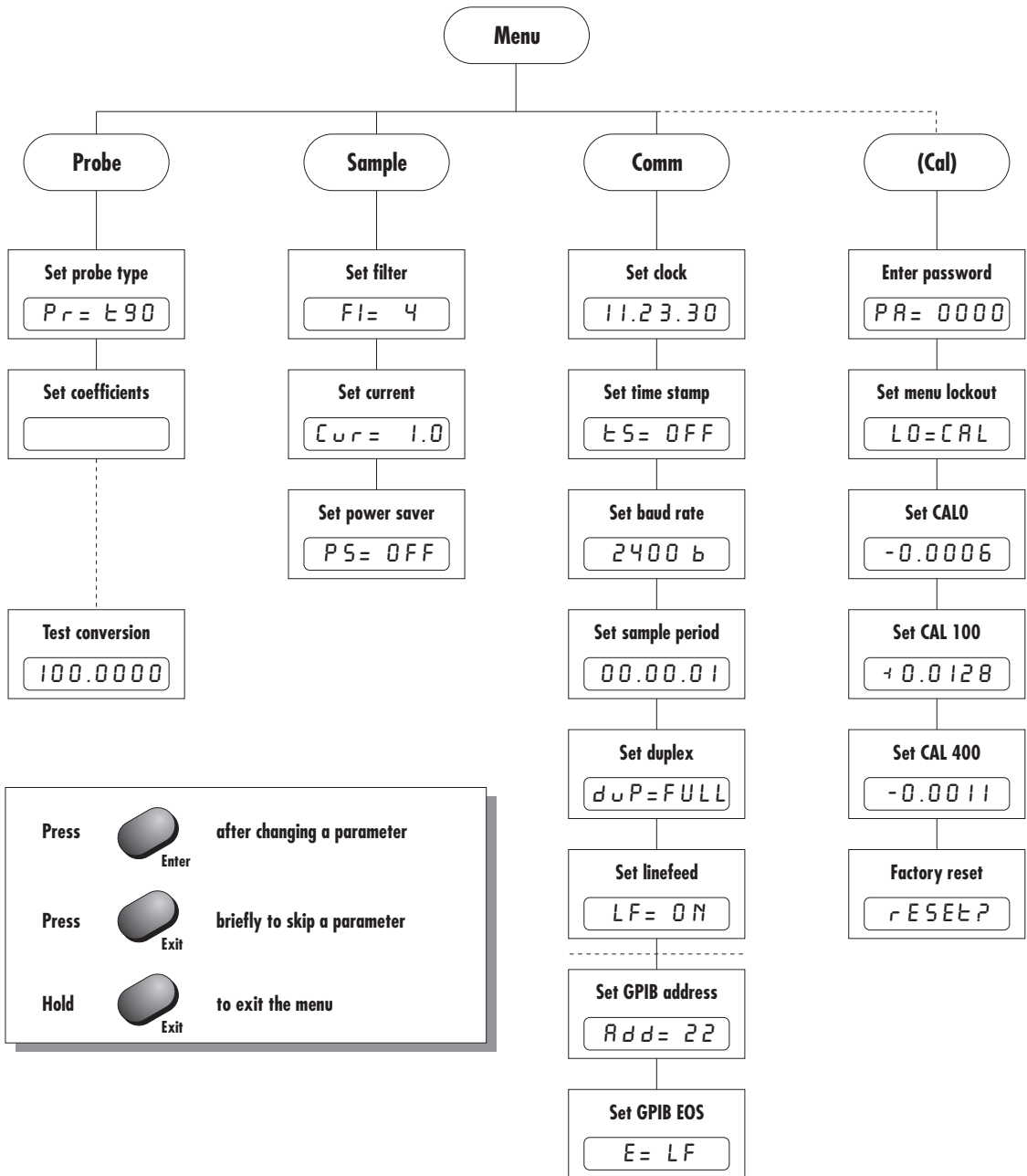

Figure 4 Parameter Menu Structure

when all the digits are correct. If the password is entered correctly the first parameter in the menu will appear.

6.4 Selecting the Probe Characterization

Before the 1502A can measure temperature accurately it must know how to calculate temperature from the resistance of the sensor. You must select a conversion type and enter the proper characterization coefficients. There are several temperature conversion algorithms available. The one to use depends on the type of probe you are using and its calibration. The conversion algorithms use coefficients that characterize the sensor. Coefficients are determined when the probe is calibrated. SPRTs and PRTs often use the ITS-90 algorithms and are provided with ITS-90 characterization coefficients.



6.4.1 Setting the Probe Characterization Type

The probe characterization type and characterization coefficients are set in the **Probe** menu. Press the **Menu** button (“SETP” appears), then the **C/Probe** button. The menu name, “PRobE”, will appear briefly then the characterization type. The probe characterization types are indicated on the display as follows:

Pr = t90 *ITS-90*

Pr = rtd *Callendar-Van Dusen*

Pr = t68 *IPTS-68*



Select the desired probe characterization type using the  and  buttons and pressing the **Enter** button. After the characterization type is selected the characterization coefficients follow. The coefficients that appear depend on the probe type that was selected.



6.4.2 Setting the Characterization Coefficients

Probe characterization coefficients are set within the **Probe** menu after selecting the probe characterization type. Each coefficient appears with the name of a coefficient shown briefly followed by its value. For example,

R4



+4.336079

For some coefficients, you only need to set the digits in the number. Other coefficients also have a sign as shown above (positive sign appears as “+”). Use the  and  buttons to move between the digits (and the sign). The selected

digit will flash. Use the  and  buttons to change a digit. Once the sign and digits are correct, press **Enter** to accept the number. If you decide to cancel any changes you have made, you may do so by pressing the **Ω/Exit** button. This will immediately skip to the next coefficient.

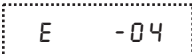
If the coefficient also requires an exponent, it will appear after setting the number as follows:



Increase or decrease the exponent using the  and  buttons. Once the exponent is correct, press **Enter** to accept it.

6.4.3 ITS-90 PRT and Coefficients

The ITS-90 option is for PRTs calibrated and characterized using the *International Temperature Scale of 1990* equations. The parameters that appear when ITS-90 is selected are "R0.01", "A", "b", "C", "d", "A4", and "b4". These should be set with the corresponding values that appear on the calibration certificate for the PRT. The parameter "R0.01" takes the triple point of water resistance, often labeled "Rtpw" or "R(273.16K)" on the certificate. Parameters "A", "b", "C", and "d" take the a_n , b_n , c_n , and d coefficients where n is a number from 5 to 11. Parameters "A4" and "b4" take the a_4 and b_4 coefficients or the a_5 and b_5 coefficients on the certificate. *Any ITS-90 parameter of the 1502A that does not have a corresponding coefficient on the PRT's certificate must be set to 0.*

The following table shows which parameter to set for each of the coefficients that may appear on the certificate. The examples that follow demonstrate how to set the ITS-90 parameters for certain cases. (Note: If the certificate has two sets of coefficients, one set for "zero-power" calibration and one set for 1 mA calibration, use the coefficients for the 1 mA calibration.)

Table 2 Matching Certificate Values to 1502A ITS-90 Coefficients

1502A ITS-90 Coefficient	Certificate Value
A	$a_5, a_6, a_7, a_8, a_9, a_{10},$ or a_{11}
b	$b_5, b_6, b_7, b_8,$ or b_9
C	c_6 or c_7
d	d
A4	a_4 or a_5
b4	b_4 or b_5

Example 1:

A PRT was calibrated to ITS-90 and its calibration certificate states values for coefficients Rtpw, a4, b4, a8, and b8. Set the 1502A parameters with values from the certificate as follows.

Table 3 *Setting Coefficients Rtpw, a8, b8, a4, and b4*

1502A Coefficient	Certificate Value
R0.01	Rtpw
A	a8
b	b8
C	0
d	0
A4	a4
b4	b4

Example 2:

A PRT was calibrated to ITS-90 and its calibration certificate states values for coefficients Rtpw, a5 and b5. Set the 1502A parameters with values from the certificate as follows:

Table 4 *Setting Coefficients Rtpw, a5, and b5*

1502A Coefficient	Certificate Value
R0.01	Rtpw
A	a5
b	b5
C	0
d	0
A4	a5
b4	b5

Example 3:

A PRT was calibrated to ITS-90 and its calibration certificate states values for coefficients R(273.16K), a6, b6, c6, and d. Set the 1502A parameters with values from the certificate as follows:

Table 5 Setting Coefficients R(273.16), a6, b6, c6, and d

1502A Coefficient	Certificate Value
R0.01	R(273.16K)
A	a6
B	b6
C	c6
D	d
A4	0.0
b4	0.0

6.4.4 Callendar-Van Dusen (RTD) Conversion

The RTD conversion uses the Callendar-Van Dusen equation:

$$r(t[^\circ C]) = \begin{cases} R_0 \left\{ 1 + \alpha \left[t - \delta \frac{t}{100} \left(\frac{t}{100} - 1 \right) \right] \right\} & t \geq 0 \\ R_0 \left\{ 1 + \alpha \left[t - \delta \frac{t}{100} \left(\frac{t}{100} - 1 \right) - \beta \left(\frac{t}{100} - 1 \right) \left(\frac{t}{100} \right)^3 \right] \right\} & t < 0 \end{cases}$$

The coefficients R_0 , α , β , and δ can be set by the user. They are indicated as “r 0”, “ALPHA”, “BETA”, and “DELTA” on the display. The ALPHA coefficient is scaled by a factor or 1000 to allow adequate resolution. For IEC-751 or DIN-43760 sensors, the coefficients for “r 0”, “ALPHA”, “BETA”, and “DELTA” should be 100.0, 0.00385055, 1.49979, and 0.1086 respectively.

Some probes may be provided with A, B, and C coefficients for the Callendar-Van Dusen equation in the following form:

$$r(t[^\circ C]) = \begin{cases} R_0(1 + At + B^2) & t \geq 0 \\ R_0[1 + At + Bt^2 + C(t-100)t^3] & t < 0 \end{cases}$$

The A, B, and C coefficients can be converted to α , δ , and β coefficients using the following formulas:

$$\alpha = A + 100B \quad \delta = -\frac{100}{\frac{A}{100B} + 1} \quad \beta = -\frac{10^8 C}{A + 100B}$$

6.4.5 IPTS-68 Conversion

The IPTS-68 characterization converts resistance to temperature according to the International Practical Temperature Scale of 1968. The applicable coefficients are R_0 (“r 0”), α (“ALPHA”), δ (“DELTA”), a_4 (“A4”), and c_4 (“C4”). You can also select the temperature scale (“SCALE”) as IPTS-68 (“68”) or ITS-90 (“90”). Selecting ITS-90 causes the temperature to be adjusted by a small amount equal to the difference between the ITS-90 and IPTS-68 temperature scales.

6.4.5.1 Setting the Characterization Coefficients

Probe characterization coefficients are set within the **Probe** menu after selecting the probe characterization type. Each coefficient appears with its name shown briefly followed by its value. For example,

R4

+4.336079

For some coefficients, you only need to set the digits in the number. Other coefficients also have a sign as shown above (positive sign appears as “+”). Use the ◀ and ▶ buttons to move between digits (and the sign). The selected digit will flash. Use the ▲ and ▼ buttons to change a digit. Once the sign and digits are correct, press **Enter** to accept the number. If you decide you would like to cancel any changes you have made, you may do so by pressing the **Ω/Exit** button. This will immediately skip to the next coefficient.

If the coefficient also requires an exponent, it will appear after setting the number as follows:

E -04

Increase or decrease the exponent using the p and q buttons. Once the exponent is correct press **Enter** to accept it.



6.4.5.2 Testing the Coefficients

The 1502A provides a convenient method for testing the coefficients you have entered to make sure they have been entered correctly. This is done by calculating temperature for given resistances and comparing the results with temperatures listed on the probe’s calibration report. This conversion test function is located at the end of the **Probe** menu. After setting the coefficients “E E 5 E” appears briefly followed by the resistance value. You can change the resistance by using the ◀ and ▶ buttons to move between digits and the ▲ and ▼ buttons to change a digit. After setting the resistance press **Enter**. The 1502A will calculate and display the temperature corresponding to the resistance you entered.



Compare this temperature with the temperatures listed on the probe calibration report to verify that the coefficients you entered are correct.

6.5 Filtering

While measuring temperature, the readings may appear to vary. This may be due to actual variations in temperature or electrical noise internal to the 1502A. The filter helps to smooth variations in the measurements and improve resolution. The drawback is that filtering tends to slow the response to changes in temperature. You can increase the filter time constant to further improve accuracy and resolution or decrease the time constant to reduce the response time. You can set it to any value between 0 and 60 seconds. A value of 0 disables the filter. The default time constant is 4 seconds.



To change the filter value, enter the **Sample** menu. This is done by first pressing the **Menu** button (“SETP” appears) then pressing the **F/Sample** button. The display will briefly indicate “SRPR”, then “FILTER”, then the current filter value. Use the  and  buttons to increase or decrease the filter value then press **Enter**. The next parameter in the menu, the current, will then appear.

6.6 Setting the Current

You can select one of two options for the probe excitation current: 1.0 mA (default) or 0.5 mA. The current is set within the **Sample** menu. Press the **Menu** button (“SETP” appears) then press the **F/Sample** button. The filter value will appear. Press **Enter** to continue. The display will briefly show “CURRENT” followed by the value for the current. You can use the  and  buttons to change the value for the current. Press **Enter** to continue.

6.7 Power Saver

The power saver feature causes the display to blank after a period of no user activity. The power saver feature can reduce operating current by as much as 100 mA. While the display is blanked a small illuminated dot appears on the left side of the display as an indication that the 1502A is still operating. Pressing any button on the front panel restores the display. You can program the power saver to activate after a specified period of time from 5 minutes to 60 minutes in intervals of 5 minutes. You can also disable the power saver feature completely. The power saver is off by default.

The power saver is programmed in the **Sample** menu. Press the **Menu** button (“SETP” appears) then press the **Sample** menu button. Press **Exit** twice to skip to the power saver parameter. The display will briefly show “PDSR” followed by the power saver setting. You can use the  and  buttons to change the power saver period (in minutes) or set it to OFF. Press **Enter** to continue.

7 Digital Communications Interface

Remote communications allows an external device, such as a computer, to communicate with the 1502A to obtain measurement data and control its operation. Communication is accomplished with various commands issued to the 1502A through the RS-232 port or optional IEEE-488 port. A full list of commands is given in Section 7.3.

7.1 Serial Interface

The 1502A is equipped with an RS-232 serial port. The RS-232 interface is useful for connecting the 1502A to most any microcomputer. The RS-232 socket is located on the back panel of the 1502A. Wiring of the interface cable should be as shown in Figure 5 below. To eliminate noise, the serial cable should be shielded with low resistance between the connector (DB-9) and the shield. The protocol for RS-232 communications is 8 data bits, 1 stop bit, and no parity. The RS-232 interface uses RTS and CTS for flow control.

7.1.1 Setting the Baud Rate

The 1502A must be set to the same baud rate as the remote device. The baud rate of the 1502A can be set to 1200, 2400, 4800, or 9600. The default is 2400. The baud rate is set in the **Comm** menu. Press the **Menu** button (“SEt?” appears) then press the **K/Comm** button. The display will briefly indicate “SERIAL”, then “BAUD” and then display the current baud rate. Use the ▲ and ▼ buttons to increase or decrease the baud rate then press **Enter**. The next parameter in the **Comm** menu, the serial sample period, will then appear.

RS-232 Cable Wiring for IBM PC and Compatibles

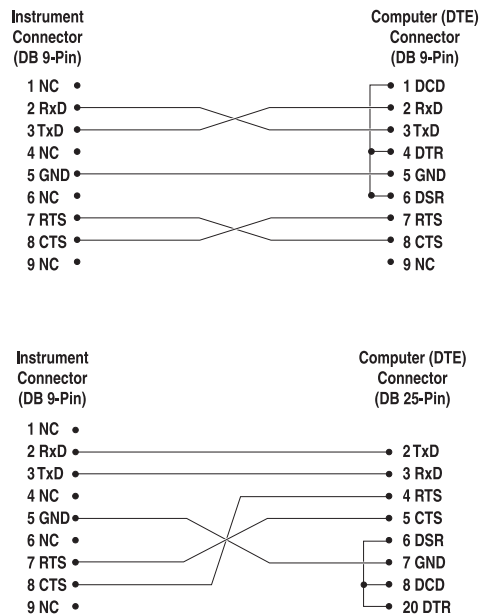

Figure 5 Serial Cable Wiring

7.1.2 Automatic Transmission of Measurements

The 1502A can be programmed to automatically send measurements to a remote printer or terminal. The transmission interval is set using the “*S R P E r*” sample period parameter. This is set in the **Comm** menu after the baud rate parameter. The display will briefly indicate “*S R P E r*” and then display the current sample period. The sample period is specified in hours, minutes, and seconds. Setting the sample period to 0 disables automatic transmission of measurements. Use the ◀ and ▶ buttons to move between digits. The selected digit will flash. Use the ▲ and ▼ buttons to increase or decrease the digit. When the sample period is set as desired press **Enter**.

The sample period can also be set using the “*S R*” communications command. The period can be specified in seconds, in minutes and seconds, or in hours, minutes, and seconds. For example, SA=15<EOS> causes the 1502A to transmit measurements at 15-second intervals. SA=10:00<EOS> causes the 1502A to transmit a measurement every ten minutes. SA=2:00:00<EOS> causes the 1502A to transmit a measurement every two hours. (<EOS> represents the termination character which is either a linefeed or carriage return).

7.1.3 Time Stamp and System Clock



The 1502A has a built-in system clock that counts hours, minutes, and seconds while the power is on. The clock can be used to time stamp measurement data read from the communications interfaces. When the power is switched on the clock is set to 00:00:00. You can set the clock to show the actual time-of-day. This can be done within the **Comm** menu. Press the **Menu** button (“*S E E P*” appears) and then the **Comm** menu button. The display will briefly show “*CLDC*” then the current clock time in hours, minutes, and seconds. The time is represented in 24-hour format with 00 hours meaning 12:00 a.m. and 23 hours meaning 11:00 p.m. Use the ◀ and ▶ buttons to move between digits. The selected digit will flash. Use the ▲ and ▼ buttons to change the digit. Once the digits are correct, press **Enter** to accept the new time. If you decide not to change the time press the **Exit** button instead.

The clock can also be set using the “*CL*” communications command: CL=hh:mm:ss <EOS>.

The time stamp allows you to record the time-of-day with measurements that are printed or transmitted to a computer. The given time is the value of the system clock at the time of transmission. An example of time-stamped readings is shown below.

```
t: 31.787 F 14:04:40
t: 31.788 F 14:04:50
t: 31.792 F 14:05:00
t: 31.793 F 14:05:10
```



The time stamp control is also accessed in the **Comm** menu. Press the **Menu** button (“*S E E P*” appears) and then the **Comm** menu button. Press **Exit** to skip

to the time stamp parameter. The display will briefly show “*TS, STATE*” then the time stamp state which is either ON or OFF. Use the  and  buttons to change the state and press **Enter**. ON enables transmission of the time stamp and OFF disables it.



The time stamp can also be set using the “*ST*” communications command. The command *ST=ON<EOS>* enables the time stamp and *ST=OF<EOS>* disables it.

The clock and time stamp parameters affect the time stamp of data read through both the RS-232 and IEEE-488 interfaces.

7.1.4 Duplex Mode and Linefeed

Commands sent to the 1502A through the RS-232 interface are normally echoed back to the remote device. To disable this feature set the duplex option to half instead of full. The duplex parameter is found in the **Comm** menu after the sample period parameter. The display will briefly indicate “*DUP*” and then display the current duplex setting. Use the  and  buttons to set duplex to “*HALF*” or “*FULL*” then press **Enter**.

Duplex can also be set using the “*DU*” communications command. The command *DU=H<EOS>* sets duplex to half and *DU=F<EOS>* sets duplex to full.

Transmissions from the 1502A through the RS-232 interface are normally followed by a linefeed character (ASCII decimal 10). The linefeed character can be disabled by setting the linefeed “*LF*” parameter to “*OFF*”. The linefeed parameter is found in the **Comm** menu after the duplex parameter. The display will briefly indicate “*LF*” and then display the current linefeed setting. Use the  and  buttons to set linefeed “*ON*” or “*OFF*” then press **Enter**.



The linefeed can also be set using the “*LF*” communications command. The command *LF=OF<EOS>* disables the linefeed character and *LF=ON<EOS>* enables it.

7.2 GPIB Interface



The 1502A is available with an optional IEEE-488 (GPIB) port. The IEEE-488 interface is useful when one computer needs to control and collect data from many instruments simultaneously. The IEEE-488 connector is located on the back panel of the 1502A above the RS-232 connector. To eliminate noise, the GPIB cable should be shielded.

The 1502A is equipped with basic communication capabilities as specified in IEEE-488.1. The particular capabilities of the IEEE-488 interface are AH1, SH1, T6, L4, DC1 (TE0, LE0, SR0, RL0, PP0, DT0). Refer to “IEEE Std 488.1-1987”. The 1502A can talk and listen and accepts the DCL and SDC clear commands. The 1502A does not respond to trigger (GET), serial poll, parallel poll, or remote/local commands and is not capable of talk-only mode.

7.2.1 Setting the Address

The IEEE-488 bus requires that each device has a unique address. The default address of the 1502A is 22 but can be changed if necessary. The IEEE-488 address of the 1502A is set within the **Comm** menu after the serial linefeed parameter. (This menu option will not appear if the IEEE-488 interface is not installed). Press the **Menu** button (“SEt” appears) then press the **Comm** button. The display will briefly indicate “SERIAL”, then “bRUd” and then display the current baud rate. Press **Enter** several times until “IEE” appears. The display will briefly indicate “RdRE55” and then display the current IEEE-488 address. Use the  and  buttons to change the number then press **Enter**.

7.2.2 Setting the Termination Character

The 1502A will normally terminate transmissions from the IEEE-488 port with a linefeed (newline) character. Some systems may require a terminating carriage return instead. The termination character can be changed if necessary. The termination character is set within the **Comm** menu after the IEEE-488 address parameter. (This menu option will not appear if the IEEE-488 interface is not installed). The display will briefly indicate “EOS” (end of string) and then display the current setting. Use the  and  buttons to change the termination character then press **Enter**.

7.2.3 Time Stamp

Measurement data read from the GPIB interface can be stamped with the time-of-day. For instructions on setting the time stamp and system clock see Section 7.1.3 above.

7.3 Remote Commands

ASCII commands are used to instruct the 1502A to perform certain actions. [Table 6](#) provides a complete list of commands. These commands can be used with either the RS-232 or IEEE-488 interface. All commands sent to the 1502A must be terminated with a carriage return or linefeed. Either upper or lower case letters are accepted. Commands used to set a parameter are issued with the command header, an “=” character, and the parameter value. For example, U=C<EOS> sets the units to Celsius. (The symbol <EOS> represents the termination character.) Commands used to request data are issued with only the command header. For example, T<EOS> causes the 1502A to return the most recent measurement. Basic operations using commands are explained in the following sub-sections.

7.3.1 Measurement Commands

The following commands relate to reading measurement data.

Table 6 Command List

Command	Description
Measurement Commands	
T	read measurement (includes label, unit, and time)
F[ETCH?]	read measurement value (SCPI compatible)
SA=[[[hh:]mm:]ss]	read [or set] serial sample period
U=CIFIKIO	select units
ST=[ON/OFF]	read [or set] the time stamp
CL=[hh:mm:ss]	read [or set] the system clock
Probe Characterization Commands	
PR=[90 68 IRIS]	read [or select] the characterization type
R0[=<value>]	read [or set] R0 or R(0.01°C) depending on the selected characterization
AL[=<value>]	read [or set] α for the Callendar-Van Dusen or IPTS-68 characterization
DE[=<value>]	read [or set] δ for the Callendar-Van Dusen or IPTS-68 characterization
BE[=<value>]	read [or set] β for the Callendar-Van Dusen characterization
A4[=<value>]	read [or set] a_4 for the ITS-90 or IPTS-68 characterization
B4[=<value>]	read [or set] b_4 for the ITS-90 characterization
C4[=<value>]	read [or set] c_4 for the IPTS-68 characterization
A n [=<value>]	read [or set] $a_6, a_7, a_8, a_9, a_{10},$ or a_{11} for the ITS-90 characterization
B n [=<value>]	read [or set] $b_6, b_7, b_8,$ or b_9 for the ITS-90 characterization
C n [=<value>]	read [or set] c_6 or c_7 for the ITS-90 characterization
D6[=<value>]	read [or set] d_6 for the ITS-90 characterization
SC=[68/90]	read [or set] IPTS-68 scale conversion
CO[=<value>]	test resistance to temperature conversion
Sample Parameter Commands	
FI[=<value>]	read [or set] filter time constant
CU[=<value>]	read [or set] probe current
PS[=<value.>]	read [or set] the power saver period
Communication parameter commands	
DU=[F/H]	read [or set] serial sample duplex mode
LF=[ON/OFF]	read [or set] serial linefeed

Command List Continued

Command	Description
Calibration Commands	
*PA=<password>	disable password lockout of calibration commands
*LO=[=CAIAL]	read [or set] menu lockout
*C0=[<value>]	read [or set] the 0Ω calibration parameter
*C1=[<value>]	read [or set] the 100Ω calibration parameter
*C4=[<value>]	read [or set] the 400Ω calibration parameter
*SN=[<value>]	read [or set] the instrument serial number
Miscellaneous Commands	
*VER	read model number and firmware version number
*IDN?	read manufacturer, model number, serial number, and firmware version number (SCPI compatible)
H	read a list of commands

7.3.1.1 Reading Temperature

The most recent temperature measurement can be read using the following command:

T<EOS> reads the most recent measurement

The syntax of the response is as follows:

t:_nnnn.nnn_u

or

t:_nnnn.nnn_u_hh:mm:ss

The _'s represent space characters. The n's represent the digits of the measurement value. If fewer digits are needed the leading positions are filled with space characters. The u represents the unit which is either 'C', 'F', 'K', or 'O' (for ohms). The time stamp appears if this option is enabled (see Section 7.3.1.4 below). The time appears in 24-hour format with two digits each for hours, minutes, and seconds.

The following SCPI compatible command can also be used to return the most recent measurement but without the label and unit.

FETC?<EOS> or

FETCH?<EOS> returns the value of the most recent measurement

7.3.1.2 Automatically Transmitting Measurements

By setting the sample period, the 1502A can be programmed to automatically transmit measurements from the RS-232 port at specified intervals. The sample period can be set remotely using the commands:

SA=[[hh:]mm:]ss<EOS> sets the sample period

SA=0<EOS> disables automatic transmission of measurements

The value of the sample period can be from 0 seconds to 24 hours. It is not necessary to give hours or minutes for values in seconds. A value of 0 disables automatic transmission of measurements. Following are some example commands.

SA=10<EOS> sets the sample period to 10 seconds

SA=5:00<EOS> sets the sample period to 5 minutes

SA=1:00:00<EOS> sets the sample period to 1 hour

7.3.1.3 Selecting the Unit of Measurement

The selected unit is used in displaying measurements on the front panel and in reading measurements from the communications interfaces. The following commands can be used to select the unit of measurement:

U=C<EOS> selects Celsius

U=F<EOS> selects Fahrenheit

U=K<EOS> selects Kelvin

U=O<EOS> selects ohms

7.3.1.4 Enabling the Time Stamp

Enabling the time stamp causes the time of the system clock to be transmitted along with measurement data. The time stamp can be enabled or disabled using the following commands:

ST=ON<EOS> enables the time stamp

ST=OFF<EOS> disables the time stamp

7.3.1.5 Setting the Clock

The system clock is set in 24-hour format using the command:

CL=hh:mm:ss<EOS>

For example:

CL=14:24:00 sets the time to 2:24 pm.

7.3.2 Probe Characterization Commands

The following commands relate to reading measurement data.

7.3.2.1 Selecting the Characterization

The following commands can be used to select the probe characterization and coefficients:

P=90<EOS> selects the ITS-90 characterization

P=68<EOS> selects the IPTS-68 characterization

P=R<EOS> or P=S<EOS> selects the standard Callendar-Van Dusen characterization

R0=<value><EOS> sets R_0 or $R(0.01C)$ depending on the selected characterization

AL=<value><EOS> sets α for the Callendar-Van Dusen or IPTS-68 characterization

DE=<value><EOS> sets δ for the Callendar-Van Dusen or IPTS-68 characterization

BE=<value><EOS> sets β for the Callendar-Van Dusen characterization

A4=<value><EOS> sets a_4 for the ITS-90 or IPTS-68 characterization

B4=<value><EOS> sets b_4 for the ITS-90 characterization

C4=<value><EOS> sets c_4 for the IPTS-68 characterization

An=<value><EOS> sets $a_6, a_7, a_8, a_9, a_{10},$ or a_{11} for the ITS-90 characterization. n is a number from 6 to 11.

Bn=<value><EOS> sets $b_6, b_7, b_8,$ or b_9 for the ITS-90 characterization. n is a number from 6 to 9.

Cn=<value><EOS> sets $c_6,$ or c_7 for the ITS-90 characterization. n is 6 or 7.

D6=<value><EOS> sets d_6 for the ITS-90 characterization

SC=69<EOS> or SC=90<EOS> sets the temperature scale for the IPTS-68 characterization

7.3.2.2 Testing the Characterization

The following command can be used to test the probe characterization:

CO=<value><EOS> returns a temperature calculated from resistance

The 1502A will respond with a temperature value computed from the given resistance value. The temperature is given in the currently selected unit. As an example, if the Callendar-Van Dusen characterization is selected with IEC-751 coefficients and the selected unit is Celsius, sending this command with a resistance value of 138.5 will return a temperature value of 100.0°C.

7.3.3 Sample Commands

The following commands relate to the measurement process.

7.3.3.1 **Setting the Filter**

The filter helps to reduce variations in the measurements. The filter can be set remotely using the command:

FI=<value><EOS> sets the filter time constant

FI=0<EOS> disables the filter

The value is the filter time constant in seconds. It must be between 0 and 60 inclusive. A value of 0 disables the filter.

7.3.3.2 **Setting the Probe Current**

The probe excitation current can be set remotely using the commands:

CU=1<EOS> sets the current to 1 mA

CU=.5<EOS> sets the current to 0.5 mA

7.3.3.3 **Setting the Power Saver**

Activating the power saver can conserve power. The power saver causes the display to blank if no front panel buttons are pressed for a given number of minutes. The power saver can be set using the commands:

PS=<value><EOS> sets the power saver time in minutes

PS=0<EOS> or PS=OF<EOS> disables the power saver

The value is the power saver time-out period in minutes. It must be between 0 and 60 inclusive. It is automatically rounded to a multiple of five minutes. A value of 0 or OFF disables the power saver.

7.3.4 **Communication Commands**

The following commands relate to external communications.

7.3.4.1 **Setting the Duplex Mode**

When the RS-232 duplex mode is set to FULL all commands received by the 1502A from the RS-232 port are echoed back. Setting the mode to HALF disables the echo. The duplex mode can be set remotely using the commands:

DU=F<EOS> sets duplex to full

DU=H<EOS> sets duplex to half

7.3.4.2 **Setting the Linefeed Option**

When the RS-232 linefeed option is enabled any data transmitted from the RS-232 port is terminated with a carriage return and a linefeed. Disabling the linefeed sets the termination to carriage return only. The linefeed option can be set remotely using the commands:

LF=ON<EOS> enables linefeed

LF=OF<EOS> disables linefeed

7.3.5 Calibration Commands

The following commands are used in calibrating the instrument.

7.3.5.1 Entering the Password

In order to set the calibration parameters the password must be issued first. The following command enables access to the calibration parameters:

*PA=2051<EOS> enables the calibration commands

Calibration parameters can be locked out again by sending *PA=0 or by cycling the power.

7.3.5.2 Setting the Menu Lockout

The following commands can be used to select the menu lockout options:

*LO=CA<EOS> locks out only the calibration menu

*LO=AL<EOS> locks out all menus

7.3.5.3 Setting the Calibration Coefficients

The instrument calibration coefficients are used to maintain the resistance measurement accuracy of the 1502A. These coefficients must not be changed except by a qualified technician during the calibration of the 1502A. The following commands can be used to set the instrument calibration coefficients:

*C0=<value><EOS> sets the calibration parameter CAL0

*C1=<value> <EOS> sets the calibration parameter CAL100

*C4=<value><EOS> sets the calibration parameter CAL400

7.3.5.4 Setting the Serial Number

The following command is used to set the serial number of the 1502A:

*SN=<value><EOS> sets the instrument's serial number

7.3.6 Other Commands

Remaining commands are described below.

7.3.6.1 Instrument Identification

The following command returns the model number and firmware version number:

*VER<EOS> returns the model and firmware version numbers

The syntax of the response is as follows:

ver.*mmmmm*,*v.vv*

The *m*'s represent digits of the model number. The *v*'s represent the digits of the firmware version number. As an example, if the version number was 1.10 the response would be "ver.1502A,1.10".

The following IEEE-488.2 and SCPI compatible command can be used to read the manufacturer, model number, serial number, and firmware version number.

*IDN?<EOS> returns identification data for the instrument

The syntax of the response is as follows:

HART,1502A,<*serial number*>,*v.vv*

The *v*'s represent the digits of the firmware version number. As an example, if the serial number was 6A1202 and the version number was 1.10 the response would be "HART,1502A,6A1202,1.10".

7.3.6.2 Reading a List of Commands

The following command returns a list of commands:

H<EOS>

or

HELP<EOS> returns a list of commands

8 Calibration Procedure

The 1502A uses a three-point calibration scheme with a quadratic polynomial correction function to maintain the accuracy of its resistance measurement. The three calibration points are at 0Ω , 100Ω , and 400Ω . Three calibration parameters determine the correction function: CAL0, CAL100, and CAL400. The CAL0 parameter sets the correction at 0Ω resistance (but does not affect the correction at 100Ω). The CAL100 parameter sets the correction at 100Ω resistance (but does not affect the correction at 0Ω). The CAL400 parameter sets the correction at 400Ω resistance (but does not affect the correction at 0 and 100Ω). Adjusting the calibration parameters directly affects the measurement at the specific resistances. For example, increasing the CAL100 parameter by 0.005 increases the measured value at 100Ω by 0.005Ω .

8.1 Accessing the Calibration Parameters

The calibration parameters are accessed in the **Cal** menu. The calibration parameters are protected by requiring the correct password to access them. Press the **Menu** button, “5EE?” appears. Press the **Ω /Exit** button and hold it down for one second, “CAL” appears briefly. The display will show “PA= 0000” and allow you to change the number to the correct password. You must enter the password (“2051”). Use the **◀** and **▶** buttons to move between the password digits and the **▲** and **▼** buttons to increase or decrease the value of a digit. Press **Enter** when all the digits are correct. If the password is entered correctly the first parameter in the calibration menu will appear.

The first parameter in the **Cal** menu is the lockout control parameter, indicated on the display as “L0000”. This parameter has two options, “CAL” and “ALL”. “CAL” (default) locks out the calibration menu only. “ALL” locks out all menus and access to any menu requires the correct password. Use the **◀** and **▶** buttons to select the lockout option and press **Enter** to continue. The instrument calibration parameters follow.

The calibration parameters appear with the name shown briefly then the value. You can change the sign and digits of each parameter. Use the **◀** and **▶** buttons to move between digits and the **▲** and **▼** buttons to increase or decrease the value of the digit. Press **Enter** to save the new value.

The last parameter in the **Cal** menu is the factory reset function. This can be used to clear the internal memory and reset all parameters to the default values. This is intended to be used only at the factory.

The calibration parameters can also be set using remote commands through the RS-232 or IEEE-488 interface. The *PA=<password><EOS> command must be used first, using the correct password (“2051”), to enable access to the calibration parameters. Lockout protection is automatically set by cycling the

power. The *C0=<value><EOS>, *C1=<value> <EOS>, and *C4=<value><EOS> commands can be used to set the values of the CAL0, CAL100, and CAL400 parameters respectively.

8.2 Calibration Procedure

Calibration requires four-wire 100 Ω and 400 Ω resistors of 6.25 ppm uncertainty and a 0 Ω resistor (or short). For verification, 25 Ω and 200 Ω resistors of 10 ppm accuracy are also required. The resistors are connected to the input the same way probes are. The calibration procedure is as follows:

1. Connect a 0 Ω resistor to the input and measure its resistance. Note the average error in the measurement. Adjust the CAL0 parameter by subtracting the measured error. For example, if the input is exactly 0.0000 Ω and readout shows -0.0011 Ω , the CAL0 parameter should be adjusted by adding 0.0011 to it.
2. Connect a 100 Ω resistor to the input and measure its resistance. Note the average error in the measurement. Adjust the CAL100 parameter by subtracting the measured error. For example, if the input is exactly 100.000 Ω and the readout shows 100.029 Ω , the CAL100 parameter should be adjusted by subtracting 0.029 from it.
3. Connect a 400 Ω resistor to the input and measure its resistance. Note the average error in the measurement. Adjust the CAL400 parameter by subtracting the measured error. For example, if the input is exactly 400.000 Ω and the readout shows 399.991 Ω , the CAL400 parameter should be adjusted by adding 0.009 to it.
4. Verify the accuracy at 0 Ω , 25 Ω , 100 Ω , 200 Ω , and 400 Ω . The accuracy should be within the short-term accuracy limits given in the specifications.

9 Maintenance

- The calibration instrument has been designed with the utmost care. Ease of operation and simplicity of maintenance have been a central theme in the product development. Therefore, with proper care the instrument should require very little maintenance. Avoid operating the instrument in an oily, wet, dirty, or dusty environments.
- If the outside of the instrument becomes soiled, it may be wiped clean with a damp cloth and mild detergent. Do not use harsh chemicals on the surface which may damage the paint or the plastic of the outside shell.
- If a hazardous material is spilt on or inside the equipment, the user is responsible for taking the appropriate decontamination steps as outlined by the national safety council with respect to the material.
- If the mains supply cord becomes damaged, replace it with a cord with the appropriate gauge wire for the current of the instrument. If there are any questions, call an Authorized Service Center for more information.
- Before using any cleaning or decontamination method except those recommended by Hart, users should check with an Authorized Service Center to be sure that the proposed method will not damage the equipment.
- If the instrument is used in a manner not in accordance with the equipment design, the operation of the thermometer may be impaired or safety hazards may arise.

10 Troubleshooting

In case you run into difficulty while operating the 1502A, this section provides some suggestions that may help you solve the problem. Below are several situations that may arise followed by possible causes of the problem and suggested actions you might take.

Incorrect Temperature Reading

While attempting to measure temperature the display shows an incorrect value.

If the temperature readings seem to be incorrect you should first check to see if the resistance is being measured correctly. Select ohms to display resistance. If the resistance is incorrect refer to the next subsection for troubleshooting incorrect resistance readings. If the resistance is being measured correctly but the displayed temperature value is incorrect consider the following possibilities.

- **One or more coefficients are incorrect.** This is a common mistake. While entering coefficients it is easy to miss a digit or sign. Check all the values carefully comparing them with the values on the calibration certificate for the probe.
- **The selected conversion type is incorrect.** Check to make sure the correct conversion type (ITS-90, RTD, or IPTS-68) is selected.
- **The measurement is out of range.** The 1502A may not be able to calculate temperature accurately if the resistance is outside the valid range. The measured resistance may be too low or too high if the actual temperature is too low or too high or if there is a problem with the sensor (see below).

Incorrect Resistance Reading

While attempting to measure resistance the display shows an incorrect value. Consider the following possibilities.

- **Poor or incorrect connection of the probe.** A common mistake is to connect the wires of the probe to the wrong terminals. Check the wiring carefully (see Figure 1 on page 12).
- **Open, shorted, or damaged sensor or lead wires.** Check the resistance across the sensor using a hand-held DMM. Also check the resistance between common pairs of leads. Check to make sure there is no conductivity between any of the leads and the probe sheath. Use a good-quality sensor to avoid errors caused by drift, hysteresis, or insulation leakage.
- **Electrical interference.** Intense radio-frequency radiation near the 1502A or the probe can induce noise into the measurement circuits resulting in erratic readings. The 1502A is intended to operate in a laboratory environment with limited radio-frequency noise. If interference seems to be a problem you might try eliminating the source of interference or moving the 1502A to a different location. A well-grounded, shielded cable should be used for the probe leads.

- **Stem conduction error.** The problem may be that the actual temperature of the sensor is not what you expect. This is often the result of stem conduction where heat flowing through the stem of the probe to ambient affects the temperature of the probe. It is very important that immersion probes be inserted to an adequately depth into the material being measured. Measuring temperature using a surface sensor can be especially difficult as the sensor is directly exposed to ambient.

Error Message at Power Up

The 1502A reports an error during the power up self-test.

On power up the 1502A performs a self-test of several of its key components. A failure of a component will cause an error message to be displayed such as “Err 4”. The possible error messages and their meanings are as follows:

- Err 1 Static RAM failure.
- Err 2 Nonvolatile RAM failure.
- Err 3 Internal data structure error.
- Err 4 ADC initialization failure.
- Err 5 ADC operation error.

Generally, each of these conditions require a qualified factory technician to replace a faulty component. Contact the factory for assistance. One possible exception might be if a large static discharge nearby disturbs the circuits. Cycling the power off and back on again may allow the 1502A to resume normal operation. Another might be if the AC source voltage is incorrect, e.g. using 115 V when the 1502A is configured for 230 V. Check the source voltage and the 1502A's configuration and make sure they agree.

10.1 CE Comments

10.1.1 EMC Directive

Fluke Corporation, Hart Scientific Division's equipment has been tested to meet the European Electromagnetic Compatibility Directive (EMC Directive, 89/336/EEC). The Declaration of Conformity for your instrument lists the specific standards to which the unit was tested.

The instrument was designed specifically as a test and measuring device. Compliance to the EMC directive is through IEC 61326-1 *Electrical equipment for measurement, control and laboratory use – EMC requirements (1998)*.

As noted in the IEC 61326-1, the instrument can have varying configurations. The instrument was tested in a typical configuration with shielded, grounded probe and RS-232 cables. Emissions may, in non-typical applications, exceed the levels required by the standard. It is not practical to test all configurations, as the manufacturer has no control over the probes the user may connect to the instrument.

10.1.1.1 Immunity Testing

The instrument was tested to the requirements for industrial locations. This allows the instrument to be used in all types of locations from the laboratory to the factory floor. Criterion C was used for Electrostatic Discharge (ESD, IEC 61000-4-2) and Electric Fast Transit (EFT, Burst, IEC 61000-4-4). If the instrument is subjected to EFT conditions at 2kV, the instrument may require the user to cycle the power to return to normal operation.

10.1.1.2 Emission Testing

The instrument fulfills the limit requirements for Class A equipment but does not fulfill the limit requirements for Class B equipment. The instrument was not designed to be used in domestic establishments.

10.1.2 Low Voltage Directive (Safety)

In order to comply with the European Low Voltage Directive (73/23/EEC), Hart Scientific equipment has been designed to meet the IEC 1010-1 (EN 61010-1) and the IEC 1010-2-010 (EN 61010-2-010) standards.