

FLUKE®

1000FLT

Fluorescent Light Tester

Users Manual

July 2014

© 2014 Fluke Corporation. All rights reserved. Specifications are subject to change without notice.

All product names are trademarks of their respective companies.

LIMITED WARRANTY AND LIMITATION OF LIABILITY

The main body of this Fluke product will be free from defects in material and workmanship for three years from the date of purchase. The rod extender will be free from defects in material and workmanship for one year from the date of purchase. This warranty does not cover fuses, disposable batteries, or damage from accident, neglect, misuse, alteration, contamination, or abnormal conditions of operation or handling. Resellers are not authorized to extend any other warranty on Fluke's behalf. To obtain service during the warranty period, contact your nearest Fluke authorized service center to obtain return authorization information, then send the product to that Service Center with a description of the problem.

THIS WARRANTY IS YOUR ONLY REMEDY. NO OTHER WARRANTIES, SUCH AS FITNESS FOR A PARTICULAR PURPOSE, ARE EXPRESSED OR IMPLIED. FLUKE IS NOT LIABLE FOR ANY SPECIAL, INDIRECT, INCIDENTAL OR CONSEQUENTIAL DAMAGES OR LOSSES, ARISING FROM ANY CAUSE OR THEORY. Since some states or countries do not allow the exclusion or limitation of an implied warranty or of incidental or consequential damages, this limitation of liability may not apply to you.

Fluke Corporation
P.O. Box 9090
Everett, WA 98206-9090
U.S.A.

Fluke Europe B.V.
P.O. Box 1186
5602 BD Eindhoven
The Netherlands

Table of Contents

Title	Page
Introduction	1
How to Contact Fluke	1
Safety Information.....	1
Before You Start	3
Power On and Off.....	3
Battery	3
Beeper On and Off.....	4
Rod Extender.....	4
Controls	5
Lamp Test.....	6
Ballast Test.....	7
Non-Contact Voltage Test (VoltAlert™)	8
Pin Test.....	10
Ballast Type Test	11
Product Care	13
How to Clean	13
Battery Replacement	14
Rod Extender Replacement.....	15
Specifications	16

List of Tables

Table	Title	Page
1.	Symbols	3
2.	1000FLT Features and Controls	5
3.	Lamp Test.....	6
4.	Ballast Test.....	7
5.	Non-Contact Voltage Test.....	9
6.	Pin Test.....	10
7.	Ballast Type Test	12
8.	Replaceable Parts	13

List of Figures

Figure	Title	Page
1.	Rod Extender	4
2.	Optical Sensor for Ballast Type Test	11
3.	Battery Replacement	14
4.	Rod Extender Replacement.....	15

Introduction

The Fluke 1000FLT Fluorescent Light Tester (Product) is an easy-to-use tool that tests fluorescent lamps, lamp pins, ballasts, and non-contact voltage (NCV). The Product includes a built-in rod extender that allows you to reach up to 1 meter (3 feet) for easier access to high fixtures.

How to Contact Fluke

To contact Fluke, call one of the following telephone numbers:

- USA: 1-800-760-4523
- Canada: 1-800-36-FLUKE (1-800-363-5853)
- Europe: +31 402-675-200
- Japan: +81-3-6714-3114
- Singapore: +65-6799-5566
- Anywhere in the world: +1-425-446-5500

Or, visit Fluke's website at www.fluke.com.

To register your Product, visit <http://register.fluke.com>.

To view, print, or download the latest manual supplement, visit <http://us.fluke.com/usen/support/manuals>.

Safety Information

A **Warning** identifies conditions and procedures that are dangerous to the user. A **Caution** identifies conditions and procedures that can cause damage to the Product or the equipment under test.

Warning

To prevent possible electrical shock, fire, or personal injury:

- **Read all safety information before you use the Product.**
- **Carefully read all instructions.**
- **Do not use VoltAlert™ if the LED test indicator does not blink when you enable the function.**
- **Test VoltAlert™ on a known voltage source before and after use to make sure the Product functions properly.**









- When using VoltAlert™, if the test indicator does not glow or the beeper does not sound, hazardous voltage could still be present.

VoltAlert™ indicates active voltage in the presence of electric fields of sufficient strength generated by the source (MAINS) voltage. If the field strength is low, the Product may not provide indication of hazardous voltages. Lack of an indication may occur if the Product is unable to sense the presence of voltage which may be influenced by several factors including, but not limited to:

- Shielded wire/cables
 - Adjacent grounded conductors
 - Thickness and type of insulation
 - Distance from the voltage source
 - Fully-isolated users that prevent an effective ground
 - Receptacles in recessed sockets and/or differences in socket design
 - Condition of the Product and batteries
- Use the Product only as specified, or the protection supplied by the Product can be compromised.
 - Do not use the Product around explosive gas, vapor, or in damp or wet environments.
 - Do not use the Product if it operates incorrectly.
 - Disable the Product if it is damaged.
 - Keep fingers behind the finger guards on the Product.
 - Do not connect directly to mains.
 - Close and lock the battery door before you operate the Product.
 - Do not allow the rod extender to contact live voltage source.
 - Do not touch the rod extender while performing the LAMP TEST. While the LAMP TEST source voltage is not considered hazardous for electric shock or electric burn, the source can cause mild pain or surprise.
 - For use by competent personnel only.

Table 1 is a list of symbols used on the Product and in this manual.

Table 1. Symbols

Symbol	Description
	Important information. See manual.
	Hazardous voltage
	Power ON/OFF
	Beeper
	Battery
	Conforms to relevant Australian standards.
	Conforms to requirements of European Union and European Free Trade Association.
	Conforms to relevant South Korean EMC standards.
	Conforms to relevant North American Safety Standards.
	This product complies with the WEEE Directive (2002/96/EC) marking requirements. The affixed label indicates that you must not discard this electrical/electronic product in domestic household waste. Product Category: With reference to the equipment types in the WEEE Directive Annex I, this product is classed as category 9 “Monitoring and Control Instrumentation” product. Do not dispose of this product as unsorted municipal waste. Go to Fluke’s website for recycling information.

Before You Start

The purchase of your Product includes:

- Fluke 1000FLT
- 4 AA Batteries
- Soft Carry Case/Holster
- Quick Reference Guide
- Safety Information

Make sure that the Product shipment is complete. If not, contact Fluke (see page 1). Install the batteries before you operate the Product. See *Battery Replacement* for more information about how to install.

Power On and Off

Push  <1 second to turn on and turn off the Product. The power button has a green light around the perimeter when on. The Pin Test is the default mode when you turn on the Product.

The Product automatically turns off after 20 minutes of non-use.

Battery

The Product operates on four AA Alkaline IEC LR6 batteries.  changes from green to blinking green as a warning when the battery power is low (typically, 85 % of capacity). The Product continues to function normally.

When battery power is depleted, **Ⓢ** will blink green for 5 seconds and the Product turns off. At this battery level, the Product will not work until the batteries are replaced.

Beeper On and Off

When the product is off, push **Ⓢ** + **BALLAST TYPE** >3 seconds to turn on or turn off the beeper. One beep is on, two beeps is off. The beeper remains as set when you turn on and turn off the power.

Rod Extender

⚠️⚠️ Warning

To prevent possible electrical shock or personal injury:

- **Do not touch the rod extender while performing any test.**
- **Do not allow the rod extender to contact live voltage.**
- **Completely collapse the rod extender during the VoltAlert test.**
- **Keep fingers behind the tactile barrier.**

The rod extender allows you to reach up to 1 meter (3 feet) for easier access to high fixtures.

To use:

1. Pull the rod extender out. Do not bend. See Figure 1.
Do not touch the rod extender while you push the Lamp Test button.

2. See *Controls* section for instructions on how to use the Product.

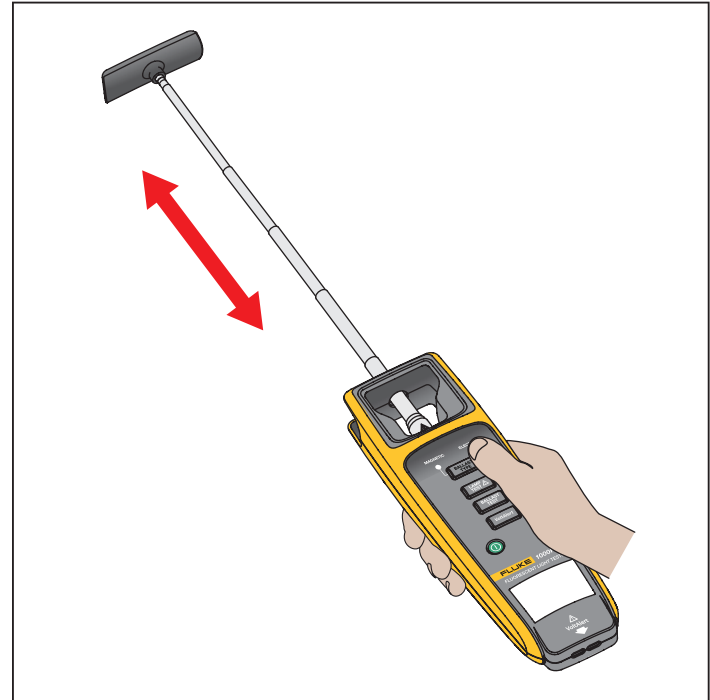

huz03.eps

Figure 1. Rod Extender

Controls

The Product has a control button for each type of test and a large LED indicator for test results. Table 2 shows the location and describes each function.

Table 2. 1000FLT Features and Controls

Item	Description
①	Power On/Off
②	Test Function Buttons
③	Rod Extender
④	Saddle
⑤	Optical Sensor
⑥	Finger Guard
⑦	LED Test Indicator Blinks green or red for test result
⑧	Pin Tester/Non-Contact Voltage Detector (VoltAlert™)

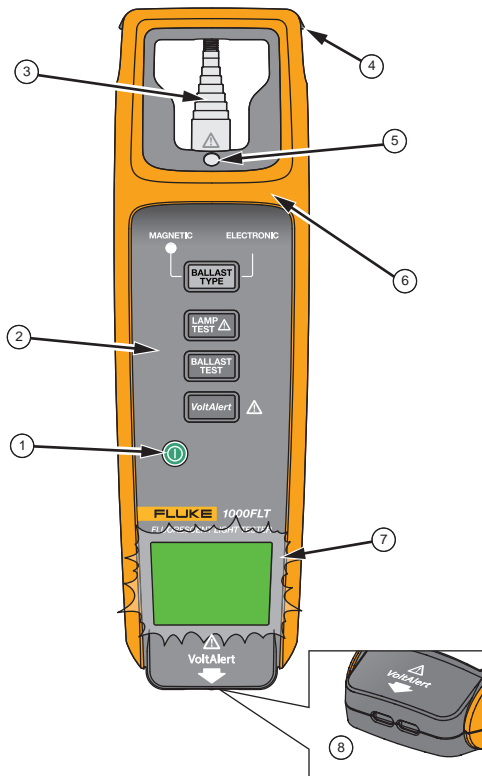

huz01.eps



Lamp Test

The Lamp Test verifies that the lamp is gas-filled. This test is done with or without the lamp in the fixture. You can test with the rod extender pulled out or collapsed.

⚠⚠ Warning

To prevent possible electrical shock or personal injury, do not touch the rod extender while performing the Lamp Test.

To test (see Table 3):

1. Turn on the Product.
2. Push  for <math>< 1</math> second. The green light around the button perimeter turns on and the LED test indicator blinks green ①. Product is ready to test.
3. Continue to push and hold  for the entire test duration.
4. Place the saddle end of the Product on the lamp and continue to hold .

If the fluorescent lamp is good (gas-filled), the fluorescent lamp starts to blink ②.

If the fluorescent lamp is bad (no gas), the fluorescent lamp does not blink ③.

5. Release  to end the test.

Note

The Product goes to the default Pin Test mode after 30 seconds of non-use.

Table 3. Lamp Test

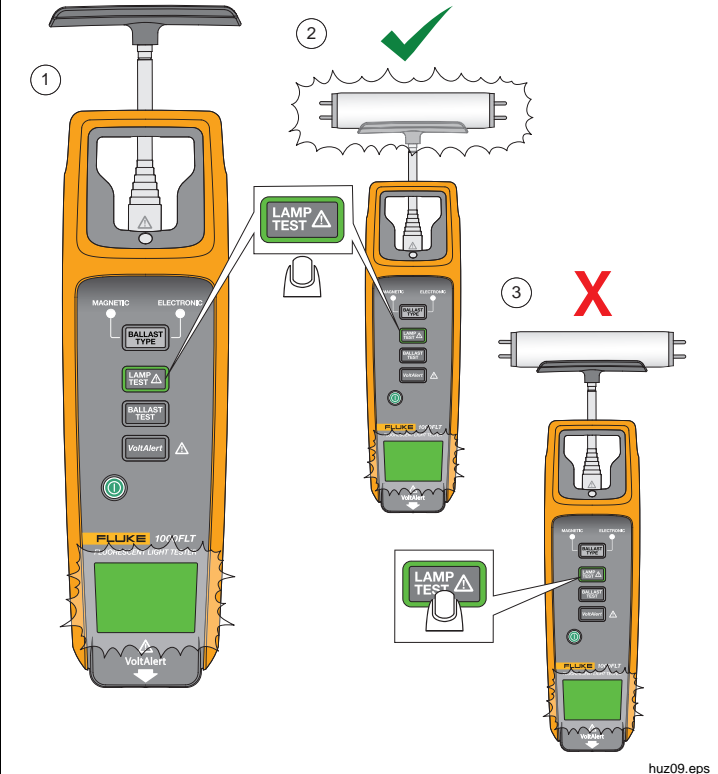

Item	LED	Description
①	blinking green	Test in progress
②	blinking green	Good fluorescent lamp blinks
③	blinking green	Bad fluorescent lamp does not blink

Ballast Test

When you hear a buzzing sound from the fixture or the lamps flicker or do not light up, check the ballast to see if it needs to be replaced. The Ballast Test verifies that the ballast is providing an ac voltage to the fluorescent lamp and senses the presence of the voltage at the filament ends of the lamp.

The fixture must be turned on for this test.

To test (see Table 4):

1. Turn on the Product.
2. Push **BALLAST TEST** for <1 second. The green light around the button perimeter turns on and the LED test indicator blinks green ①.
3. Pull out the rod extender and scan ≤ 10 cm (4 in) at both ends of the fluorescent bulb.

A solid green LED indicates that a good ballast has been found ②.

If a good ballast is not found, the LED continues to blink and times out (turns off) after 1 minute ①.

Note

The Product goes to the default Pin Test mode after 30 seconds of non-use.

Table 4. Ballast Test

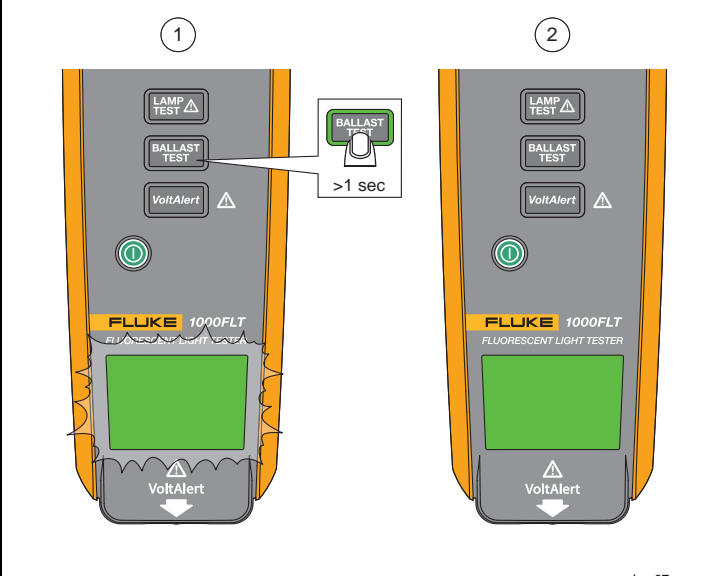

Item	LED	Description
①	blinking green	<ul style="list-style-type: none"> - Test in progress - Continues to blink green if no voltage is detected
②	solid green	<ul style="list-style-type: none"> - Test complete - Electronic ballast is good - Times out after 15 seconds

Non-Contact Voltage Test (VoltAlert™)

VoltAlert is a non-contact voltage (NCV) test of the incoming voltage to the ballast of a fluorescent light fixture. The fluorescent light fixture must be turned on for this test. The blinking red LED is a self-test feature for visual confirmation of battery and power on. It provides a double flash every 2 seconds.

⚠⚠ Warning

To prevent possible electrical shock, fire, or personal injury:

- **Do not use VoltAlert if the LED test indicator does not blink when you enable the function.**
 - **Test VoltAlert on a known voltage source before and after use to make sure the Product functions properly.**
 - **Completely collapse the rod extender during the VoltAlert test.**
 - **Do not allow the rod extender to contact live voltage.**
- **When using VoltAlert, if the test indicator does not glow or the beeper does not sound, hazardous voltage could still be present. VoltAlert indicates active voltage in the presence of electric fields of sufficient strength generated by the source (MAINS) voltage. If the field strength is low, the Product may not provide indication of hazardous voltages. Lack of an indication may occur if the Product is unable to sense the presence of voltage which may be influenced by several factors including, but not limited to:**
 - **Shielded wire/cables**
 - **Adjacent grounded conductors**
 - **Thickness and type of insulation**
 - **Distance from the voltage source**
 - **Fully-isolated users that prevent an effective ground**
 - **Receptacles in recessed sockets and/or differences in socket design**
 - **Condition of the Product and batteries**

To test (see Table 5):

1. Turn on the Product.
2. Push **VoltAlert** for <1 second. The red light around the button perimeter turns on and the LED test indicator blinks red ①.
3. Rotate the Product with the VoltAlert end towards the test object.
4. Move the VoltAlert to ≤ 10 cm (4 in) of the test object.

A solid red LED and a continuous beep (if beeper is on) indicates that line voltage has been found ②.

The indicator continues to blink red if no line voltage is found ①.

Note

The Product goes to the default Pin Test mode after 30 seconds of non-use.

Table 5. Non-Contact Voltage Test

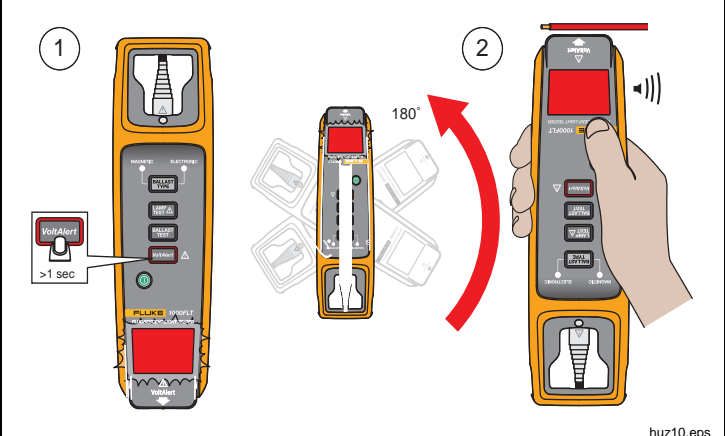

Item	LED	Description
①	blinking red	- Test in progress/no voltage found - Rotate VoltAlert end towards test object
②	solid red	- Voltage found - Continuous beep if the beeper is on

Pin Test

The Pin Test feature checks the continuity of the filament between the pins. This is the default function when the Product is turned on.

Make sure all other functions are off before you do a Pin Test. **ⓘ** should be the only button that is lit.

To test (see Table 6):

1. Turn on the Product.
2. Insert the lamp pins into the slots on the Product **ⓘ**.

The green LED test indicator shows the filament is good **ⓘ**. You will hear a continuous beep if it is on.

No color on the LED test indicator shows that the filament is broken **ⓘ**.

Table 6. Pin Test

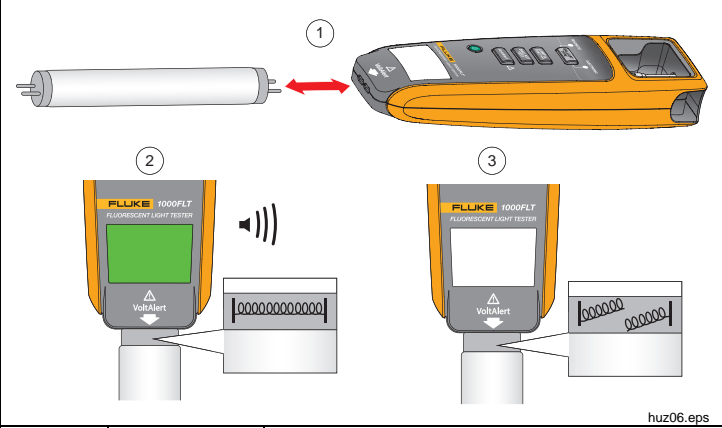

Item	LED	Description
ⓘ	no LED	Ready for Pin Test, default mode
ⓘ	solid green	Filament is good, continuous beep if the beeper is on
ⓘ	no LED	Filament is broken

huz06.eps

Ballast Type Test

The Product has an optical sensor that detects whether the ballast is magnetic or electronic (see Table 2 for the sensor location). Make sure that the entire sensor is in-line with the fluorescent light fixture as you test. See Figure 2.

The fluorescent light fixture must be turned on for this test.

Note

The Product goes to the default Pin Test mode after 30 seconds of non-use.

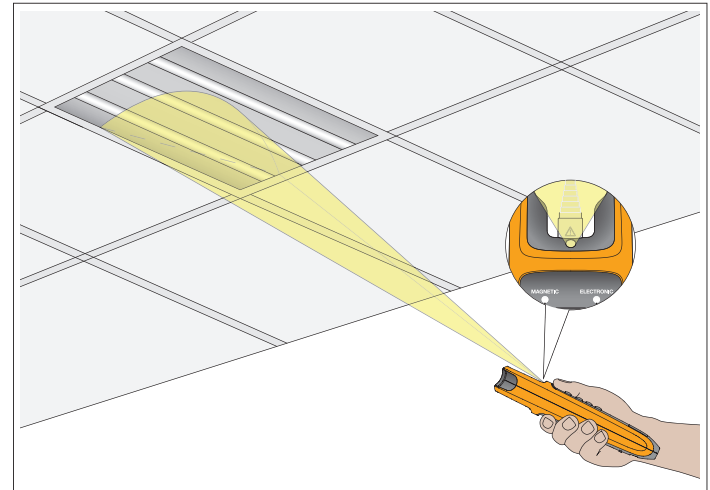

huz12.eps

Figure 2. Optical Sensor for Ballast Type Test

To test (see Table 7):

1. Turn on the Product.
2. Push **BALLAST TYPE** for <1 second.

The green light around the button perimeter turns on. The blinking green LED test indicator shows the test is in progress ①.

3. Hold the end of the Product within 3 m (10 ft) of any part of the lit fluorescent lamp.

The green LED test indicator shows the test is complete ②. See indicator for ballast type.

No color on the LED test indicator shows a test error ③.

Table 7. Ballast Type Test

Item	LED	Description
①	blinking green	Test in progress
②	solid green	Test complete, see ballast type indicator
③	no LED	Error/both type indicators blink on/off alternately. Check that the Product is within 3 m of the light fixture.

Product Care

Minimum maintenance is necessary for the Product.

Warning

To prevent possible electrical shock, fire, or personal injury:

- **Batteries contain hazardous chemicals that can cause burns or explode. If exposure to chemicals occurs, clean with water and get medical aid.**
- **Do not keep cells or batteries in a container where the terminals can be shorted.**
- **Use only specified replacement parts.**
- **Have an approved technician repair the Product**

Table 8 is a list of replaceable parts available from Fluke.

Table 8. Replaceable Parts

Description	Fluke Part Number
Holster	4532652
Rod Extender/Saddle	4550018
Quick Reference Guide	4477116
Safety Information	4472585

How to Clean

For the best results, clean the optical sensor window with a moist cloth before you take measurements. Clean the external case of the Product at regular intervals with a moist cloth and a weak detergent solution.

Caution

To prevent damage or performance loss, keep the Product dry. Do not put the Product into any liquid. The Product is not waterproof.

Battery Replacement

⚠ Warning

For safe operation and maintenance of the Product, repair the Product before use if the battery leaks.

Replace the batteries when the  light is blinking green and the Product automatically turns off.

To replace (see Figure 3):

1. Loosen the capture screw on the battery door and remove.
2. Remove the spent batteries and dispose of properly.
3. Insert new AA batteries. Make sure the battery polarity is correct.
4. Replace the battery door and tighten the screw.

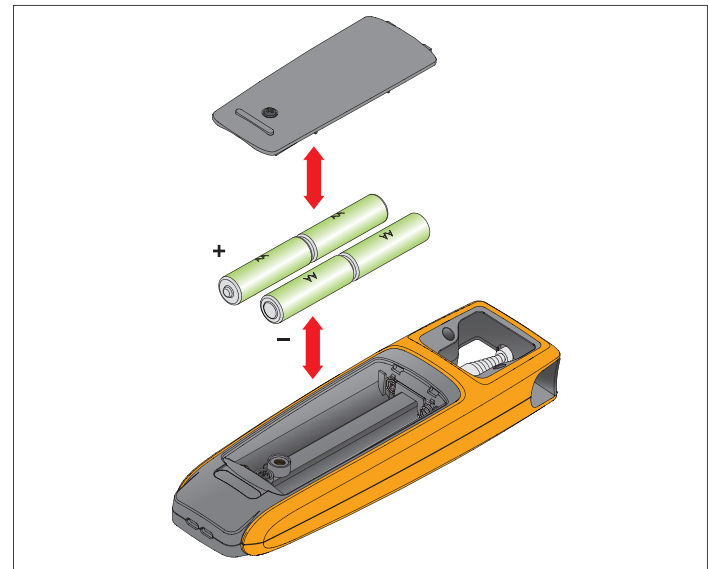

huz04.eps

Figure 3. Battery Replacement

Rod Extender Replacement

The rod extender is user replaceable. See Figure 4.

To replace:

1. Loosen the capture screw on the battery door.
2. Remove the batteries.
3. Remove the screw from the base of the rod extender.
4. Pull out the faulty rod extender from the body of the Product.
5. Slide the replacement rod extender into place.
6. Replace the screw at the base of the rod extender.
7. Replace the batteries.
8. Replace the battery door and tighten the screw.

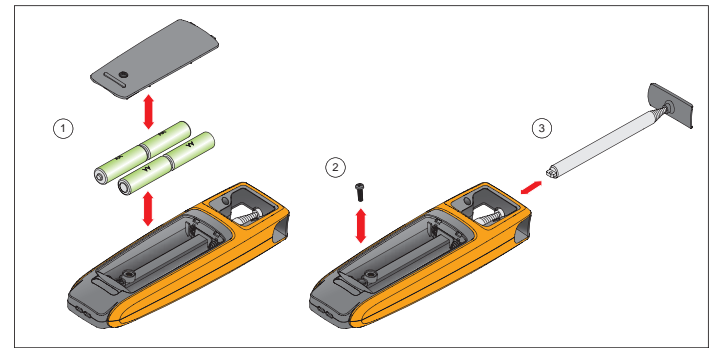

huz11.eps

Figure 4. Rod Extender Replacement

Specifications

Temperature

Operating.....	-10 °C to +50 °C (+14 °F to +122 °F)
Storage.....	-40 °C to +60 °C (-40 °F to +140 °F)

Relative Humidity..... 85 %

Operating Altitude <2000 m

Battery

Type.....	4 x AA Alkaline IEC LR6
Life.....	40 hr

NCV (VoltAlert™)..... 85 V ac to 400 V ac
45 Hz to 67 Hz
≤10 cm (4 in) distance

Pin Continuity Test..... <1 kΩ

Ballast Test..... 20 kHz

Ballast Type

Electronic.....	20 kHz
Magnetic.....	50 Hz to 60 Hz ≤3 m (10 ft) distance

Drop 2 meter

Size (H x W x L)..... 21.5 cm x 3.0 cm x 6.5 cm
(8.5 in x 1.2 in x 2.6 in)

Weight..... 0.37 kg (0.80 lb)

Warranty

Main Body.....	3 years
Rod Extender.....	1 year

Safety IEC 61010-1, Pollution Degree 2

Electromagnetic Compatibility (EMC)

EU IEC 61326-1 (Portable) CISPR 11, Group 2, Class A.

Group 2 equipment contains all ISM RF equipment in which radio-frequency energy in the frequency range 9 kHz to 400 GHz is intentionally generated and used or only used, in the form of electromagnetic radiation, inductive and/or capacitive coupling, for the treatment of material or inspection/analysis purposes.

Class A equipment is suitable for use in all establishments other than domestic and those directly connected to a low voltage power supply network which supplies buildings used for domestic purposes. Caution, there may be potential difficulties in ensuring electromagnetic compatibility in other environments, due to conducted and radiated disturbances.

US (FCC) 47 CFR 15 subpart B, this product is considered an exempt device per clause 15.103

Applies to use in Korea only (KCC)..... Class A Equipment (Industrial Broadcasting & Communication Equipment).

This product meets requirements for industrial (Class A) electromagnetic wave equipment and the seller or user should take notice of it. This equipment is intended for use in business environments and not to be used in homes.