

Voltage, Continuity, and Current Testers

VT8-600 and VT8-1000

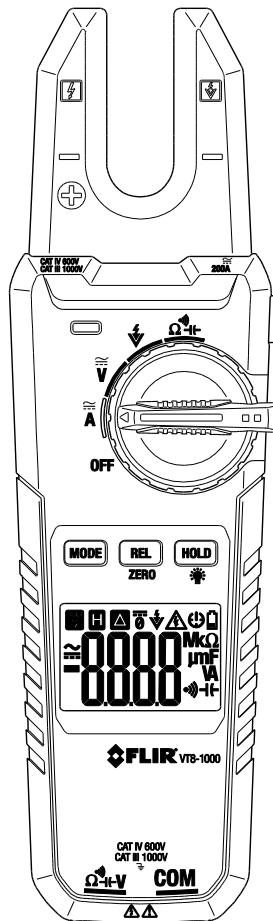
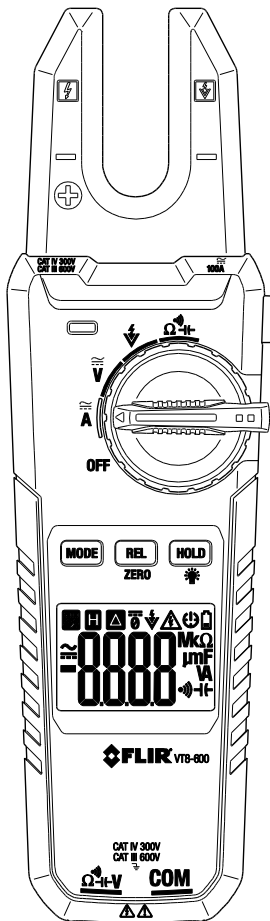

Table of Contents

1. ADVISORIES	3
1.1 Copyright	3
1.2 Quality Assurance	3
1.3 Documentation	3
1.4 Disposal of Electronic Waste	3
2. INTRODUCTION	4
2.1 Features	4
2.2 Accessories	4
3. SAFETY INFORMATION	5
4. DESCRIPTIONS	7
4.1 Meter Description	7
4.2 Display Icon Descriptions	8
4.3 Push-Button Descriptions	8
4.4 Rotary Function Switch Description	9
5. OPERATION	9
5.1 Meter Power ON/OFF	9
5.2 Display Backlight	9
5.3 Worklight	9
5.4 Data Hold	9
5.5 Test Lead Considerations	10
5.6 Voltage Measurement Warnings and Cautions	10
5.7 AC/DC Voltage Measurements	10
5.8 AC/DC Current Measurements	11
5.9 Non-Contact AC Voltage Detector	12
5.10 Resistance Measurements	13
5.11 Continuity Measurements	14
5.12 Capacitance Measurements	15
6. MAINTENANCE	16
6.1 Battery Replacement	16
6.2 Cleaning and Storage	16
7. SPECIFICATIONS	17
7.1 Electrical Specifications	17
7.2 General Specifications	19
8. TECHNICAL SUPPORT	20
9. THREE-YEAR LIMITED WARRANTY	20

1. Advisories

1.1 Copyright

© 2018, FLIR Systems, Inc. All rights reserved worldwide. No parts of the software including source code may be reproduced, transmitted, transcribed or translated into any language or computer language in any form or by any means, electronic, magnetic, optical, manual or otherwise, without the prior written permission of FLIR Systems.

The documentation must not, in whole or part, be copied, photocopied, reproduced, translated or transmitted to any electronic medium or machine readable form without prior consent, in writing, from FLIR Systems.

Names and marks appearing on the products herein are either registered trademarks or trademarks of FLIR Systems and/or its subsidiaries. All other trademarks, trade names or company names referenced herein are used for identification only and are the property of their respective owners.

1.2 Quality Assurance

The Quality Management System under which these products are developed and manufactured has been certified in accordance with the ISO 9001 standard.

FLIR Systems is committed to a policy of continuous development; therefore, we reserve the right to make changes and improvements on any of the products without prior notice.

1.3 Documentation

To access the latest manuals and notifications, go to the 'Downloads' tab at:

<http://support.flir.com>. It only takes a few minutes to register online. In the download area you will also find the latest releases of manuals for our other products, as well as manuals for our historical and obsolete products.

1.4 Disposal of Electronic Waste



As with most electronic products, this equipment must be disposed of in an environmentally friendly way, and in accordance with existing regulations for electronic waste.

Please contact your FLIR Systems representative for more details.

2. Introduction

Thank you for selecting the FLIR VT8 Series Voltage, Continuity, and Current Tester.

The VT8 series is a feature-packed Open Jaw True RMS Electrical Tester. The VT8-600 is a 100A/600V rated instrument while the VT8-1000 is rated for 200A/1000V.

Measure AC/DC voltage, AC/DC current, Resistance, Continuity, and Capacitance. This meter series also includes a Non-Contact Voltage Detector (NCV).

Other functions include Data Hold, Relative/Zero mode, Worklight, LCD Backlight, and Auto power-off (APO).

This device is shipped fully tested and calibrated and, with proper use, will provide years of reliable service. Please visit our website (www.flir.com) to check for the latest version of this User Guide, Product Updates, Product Registration, and Customer Support.

2.1 Features

- 6000 count (0 ~ 5999) digital display
- LCD display with high/low intensity backlight
- True RMS AC measurements
- 0.8% DCV accuracy
- Data Hold freezes the displayed reading
- Relative and DC Zero functions
- Auto Power OFF (APO)
- 100A (VT8-600) and 200A (VT8-1000) AC/DC current measurements
- 600V (VT8-600) and 1000V (VT8-1000) AC/DC voltage measurements
- Non-Contact Voltage Detector
- Visual and audible continuity measurement alert
- Low battery indicator
- CAT III 1000V / CAT IV 600V (VT8-1000)
- CAT III 600V / CAT IV 300V (VT8-600)

2.2 Accessories

The VT8 series includes test leads, a printed Quick Start guide, batteries, and carry pouch.

If items are missing, please contact your FLIR sales agent. If there is a need to replace the test leads, please select test leads that meet or exceed these requirements: Double insulation, CAT III 1000V, CAT IV 600V, 10A (VT8-1000) or CAT III 600V, CAT IV 300V, 10A (VT8-600)

3. Safety Information

To ensure the safe operation and service of the meter, follow these instructions closely. Failure to observe warnings can result in severe injury.

This instrument is designed and produced in strict accordance with GB4793 Safety Requirements for Electronic Measuring Apparatus and IEC61010-1 and IEC 61010-2-032 safety standards, and complies with the safety standard of double insulation, over-voltage CAT III 1000V, CAT IV 600V (VT8-1000) or CAT III 600V, CAT IV 300V (VT8-600) and pollution level 2. Please use this instrument in strict accordance with the user manual and quick start guides, failure to do so could compromise or defeat the provided protections.

Confirms to UL standards 61010-1, 61010-2-030, 61010-2-032, and 61010-2-033; Certified to CSA standards C22.2 No. 61010-1, 61010-02-030, IE CSTD 61010-2-032, and 61010-2-033.



WARNINGS

WARNINGS identify hazardous conditions and actions that could cause **BODILY HARM** or **DEATH**.





- When handling test leads or probes, keep hands and fingers behind the finger guards at all times. To avoid electrical shock do not touch exposed electrical wire, connectors, unused input terminals, or circuits under test.
- Remove test leads from the meter before opening the battery compartment or meter housing.
- Use the meter only as specified in this User Guide or accompanying Quick Manual to avoid compromising the protections provided by the meter.
- Be sure to use the proper terminals, switch positions, and ranges when taking measurements.
- Verify the meter's operation by measuring a known voltage. Have the meter serviced if the meter responds unusually or if there are questions regarding the meter's functional integrity.
- Do not apply more than the rated voltage, as marked on the meter, between terminals or between any terminal and earth ground.
- Do not measure voltages above 1000V AC/DC (VT8-1000) or 600V AC/DC (VT8-600) between terminal and ground to prevent electrical shock and damage to the electrical tester.
- Use caution working with voltages above 30 VAC RMS, 42 VAC peak, or 60 VDC. These voltages pose a shock hazard.
- To avoid misleading readings that could lead to electric shock and injury, replace the batteries as soon as the low battery indicator is displayed.
- Disconnect power to the circuit under test and discharge all high-voltage capacitors before testing resistance, continuity, diodes, or capacitance.
- Do not use the meter in the presence of explosive gas or vapor.
- To reduce risk of fire or electric shock, do not use the meter if it is wet and do not expose the meter to moisture.
- Individual protective equipment should be used if **HAZARDOUS LIVE** parts in the installation where measurements are to be carried out could be accessible.

CAUTIONS

CAUTIONS identify conditions and actions that could cause DAMAGE to the meter or equipment under test. Do not expose the meter to extremes in temperature or high humidity.

- Disconnect the test leads from the test points before changing the position of the function (rotary) switch.
- Do not expose the meter to extremes in temperature or to high humidity.
- Never set the meter to the resistance, diode, capacitance, micro-amp, or amp functions when measuring the voltage of a power supply circuit; this could result in meter damage and damage to the equipment under test.

Safety Symbols

	This symbol, adjacent to another symbol, indicates the user must refer to the manual for further information
	Risk of electrical shock
	Equipment protected by double or reinforced insulation
	Conforms to EU directives

PER IEC1010 OVERVOLTAGE INSTALLATION CATEGORY

OVERVOLTAGE CATEGORY I

Equipment of OVERVOLTAGE CATEGORY I is equipment for connection to circuits in which measures are taken to limit the transient over-voltages to an appropriate low level.

Note – Examples include protected electronic circuits.

OVERVOLTAGE CATEGORY II

Equipment of OVERVOLTAGE CATEGORY II is energy-consuming equipment to be supplied from the fixed installation.

Note – Examples include household, office, and laboratory appliances.

OVERVOLTAGE CATEGORY III

Equipment of OVERVOLTAGE CATEGORY III is equipment in fixed installations.

Note – Examples include switches in the fixed installation and some equipment for industrial use with permanent connection to the fixed installation.

OVERVOLTAGE CATEGORY IV

Equipment of OVERVOLTAGE CATEGORY IV is for use at the origin of the installation.

Note – Examples include electricity meters and primary over-current protection equipment

4. Descriptions

4.1 Meter Description

1. Non-Contact Voltage Detector
2. Open jaw hall effect Current sensor
3. NCV alert LED lamp
4. Worklight button
5. Rotary function switch
6. **REL** (Relative Δ) and **ZERO** button
7. **MODE** button
8. **HOLD** and LCD Backlight button
9. LCD Display
10. Test lead jacks
11. Worklight lens
12. Test leads in holders
13. Battery compartment
14. Compartment screw

Fig 4-1 METER DESCRIPTION

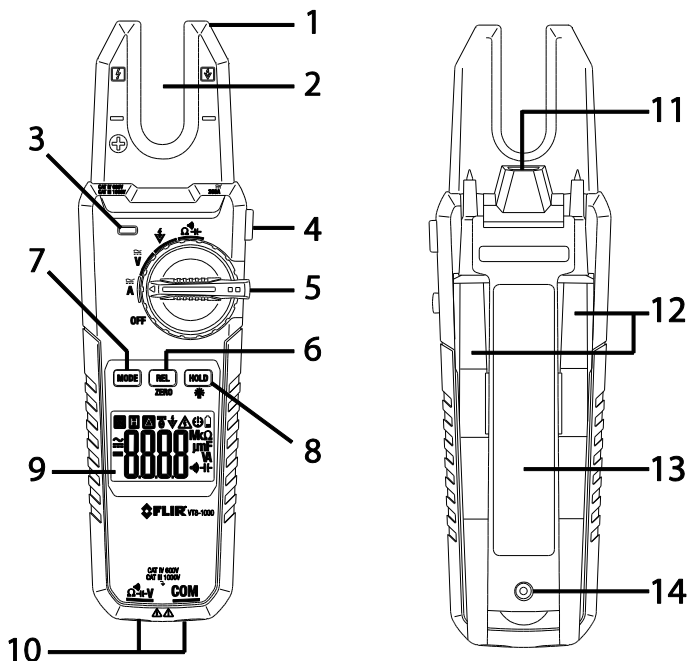

4.2 Display Icon Descriptions

1. Auto Range
2. Data Hold
3. Relative mode
4. DC Zero
5. Non-Contact Voltage detector
6. Electrical signal detected
7. Auto Power OFF (APO)
8. Battery status
9. Unit of measure and measurement function icons
10. Main display digits
11. Minus (negative) sign
12. DC (direct current)
13. AC (alternating current)

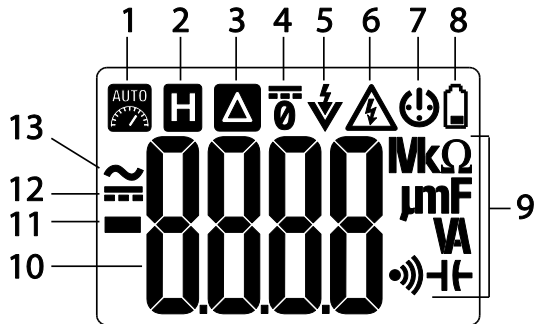











Fig 4-2 METER DISPLAY

4.3 Push-Button Descriptions

MODE: Short press to step through the functions shown in the table below.

Fig. 4-3 MODE Button Function Table

Switch Position	Mode Button Function
 	AC < > DC
 	AC < > DC
  	  

REL/ZERO: Short press to enter/exit the Relative mode. Relative mode is only available for AC/DC voltage, AC Current, and Capacitance. In DCA mode, short press to zero the display; long press to exit the zero function.

H : Data Hold (short press) and LCD backlight (long press for low intensity light, long press again for high intensity light, long press again to switch lighting OFF). See the dedicated paragraphs for Data Hold and Display Backlight in Section 5, *Operation*.

Worklight button (right side of meter): Short press to switch the light on or off.

4.4 Rotary Function Switch Description

OFF: Meter power OFF position



A : AC/DC Current mode (press **MODE** to choose AC or DC)



V : AC/DC Voltage mode (press **MODE** to choose AC or DC)



⚡ : Non-Contact Voltage Detect position



Ω : Resistance, Continuity, and Capacitance (press **MODE** to select function)

5. Operation





CAUTION: Read and understand all of the Safety statements listed in the safety section of this manual prior to use.

5.1 Meter Power ON/OFF

- Turn the rotary function switch to any position to power the meter. Replace the batteries if the unit fails to power ON (refer to the *Maintenance* section).
- Turn the function switch to the OFF position to power OFF the meter.
- The meter includes an Auto Power OFF feature (APO); the meter switches OFF after 15 minutes of inactivity.
- The low battery symbol  appears on the display when the battery voltage is insufficient.

5.2 Display Backlight

The LCD backlight has two intensity levels, low and high:

- With the LCD backlight OFF, long press the  button to activate the low intensity backlight
- With the low intensity backlight ON, long press the  button a second time to activate the high intensity backlight
- With the high intensity backlight ON, long press the  button to extinguish the LCD backlight.

5.3 Worklight

With the meter powered ON, short press the Worklight button on the right side of the meter to switch the Worklight ON or OFF. Excessive Worklight use will shorten battery life.

5.4 Data Hold

To freeze the LCD meter reading, short press the **HOLD** (Data Hold) button. While data hold is active, the **H** display icon appears on the LCD. Short press **HOLD** to return to normal operation. The **H** icon will switch OFF.

5.5 Test Lead Considerations

Test lead probe covers can be removed for CAT II 1000V installations. Use the test lead probe covers for CAT III 1000V and CAT III 600V installations. Do not measure voltages > 1000V AC/DC (VT8-1000) or > 600V AC/DC (VT8-600). Remove the storage caps from the meter end of the test leads before connecting the test leads to the meter.

5.6 Voltage Measurement Warnings and Cautions

WARNING:

Remove the test lead probe covers for CAT II 1000V installations. Use the test lead probe covers for CAT III 1000V and CAT III 600V installations.

Do not measure voltages > 1000V AC/DC (VT8-1000) or 600V AC/DC (VT8-600).

 CAUTION: When connecting the test leads to the circuit or device under test, connect the black lead before the red; when removing the test leads, remove the red before the black lead.

Disconnect probes and circuit under test after all measurements are completed.

5.7 AC/DC Voltage Measurements

1. Insert the black test lead banana plug into the negative (COM) jack and the red test lead banana plug into the positive (V) jack.
2. Turn the function switch to the  position. Use the **MODE** button to select AC or DC.
3. Read the Warning and Caution statements above to determine whether or not to use the test lead probe covers.
4. Touch the test probe tips to the circuit under test. For DC measurements observe the correct polarity (red lead to positive, black lead to negative).
5. Read the digital value shown on the display. The meter is Auto Ranging and therefore selects the proper decimal point position. For DC, when the polarity is reversed, the display will show the (-) minus sign before the value.
6. The VT8-1000 is rated for 1000VAC/DC and the VT8-600 is rated for 600VAC/DC.

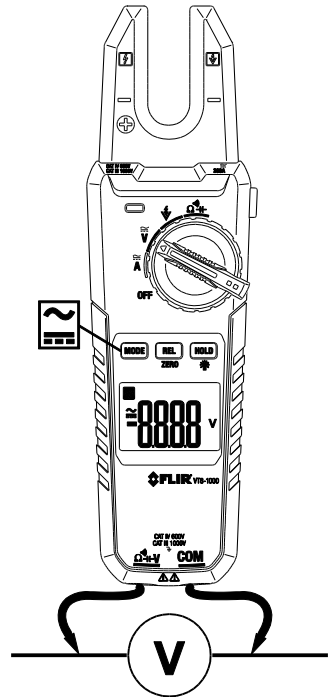

Fig 5-1 AC and DC VOLTAGE MEASUREMENTS

5.8 AC/DC Current Measurements

⚠ WARNING: Do not measure the current on a circuit when the voltage increases to more than 1000V AC/DC (VT8-1000) or 600V AC/DC (VT8-600). This can cause damage to the instrument and can cause injury to persons.

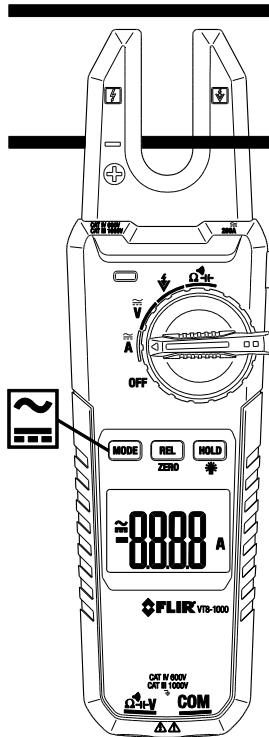

Fig 5-2 Test only one conductor

1. Ensure that the probe leads are disconnected from the meter.
2. Set the function switch to the \approx **A** position.
3. Use the **MODE** button to select **AC** or **DC**. For DC press **ZERO** to remove any residual magnetism before testing a conductor.
4. Test only one conductor and position the conductor as close to the center of the jaw opening as possible.
5. Read the current measurement in the display. The display will indicate the proper decimal point and value. In DC, when the polarity is reversed, the display will show (-) minus before the value.
6. The VT8-1000 is rated for 200A and the VT8-600 is rated for 100A maximum.

5.9 Non-Contact AC Voltage Detector

⚠ WARNING: It is possible for voltage to be present in a circuit even if the meter does not beep or flash the NCV LED lamp. Always verify meter operation on a known live AC current circuit and verify that the batteries are fresh before use.

When the meter senses an AC Voltage or electromagnetic field > 100VAC, the following occurs:

- The meter produces audible tones (beeps)
- The LED lamp flashes ON and OFF
- The display shows 1, 2, 3, or 4 dashes

The greater the electrical field strength, the faster the rate of the audible tones, the flashing of the LED lamp, and the number of dashes displayed. If the meter does not emit a tone or flash the LED, there is still the possibility that voltage is present; **please use caution.**

1. Turn the function switch to the  position to select Non-Contact Voltage Detect mode.
2. Note that **EF** is displayed when in this mode. If the **EF** does not display when the function switch is turned to the NCV position, check the batteries and do not use the meter until **EF** is displayed.
3. To test, place the meter near a source of electrical energy. Note that the tip of the meter offers the highest sensitivity.
4. Note the audible beeping, the flashing LED, and the displayed dashes when a source of electrical energy is detected.

Fig 5-3 NON-CONTACT VOLTAGE DETECTOR



5.10 Resistance Measurements

CAUTION: Switch OFF power to the device under test before measuring. Do not test on circuits or devices where 60VDC or 30VAC is present.

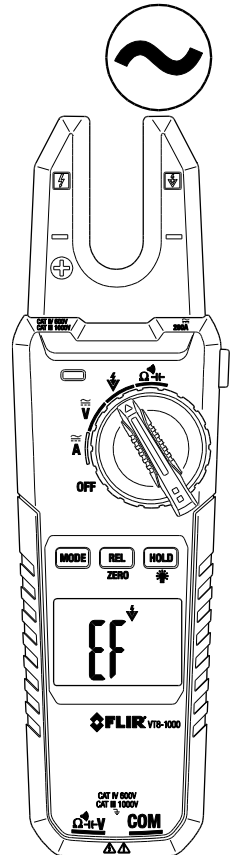
1. Insert the black test lead banana plug into the negative (COM) jack. Insert the red test lead banana plug into the positive (V/ Ω) jack.
2. Turn the Function Switch to the Ω position.
3. Press **MODE** to select the Ω icon on the display.
4. Touch the test probe tips across the circuit or part under test. It is best to disconnect one side of the part under test so the rest of the circuit will not interfere with the resistance reading.
5. For resistance values, use the **REL** button (Relative mode Δ) to remove test lead residual resistance.
6. Read the resistance value in the display. The display will indicate the proper decimal point and value. If the reading is out of range, the **OL** display icon will appear.

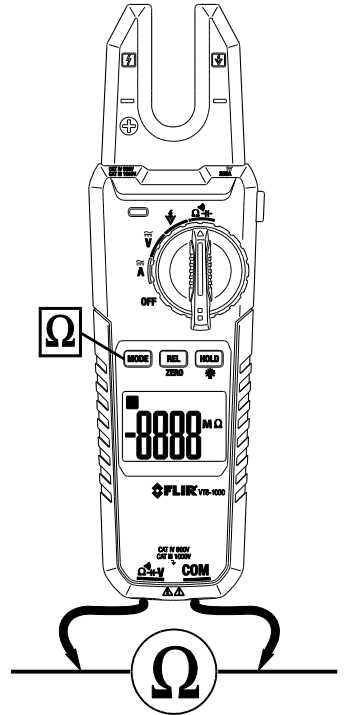

Fig 5-4 RESISTANCE MEASUREMENTS

Resistance Measurement Notes:

- The display will show “OL” when an open circuit is detected or if the resistance > maximum range.
- The test leads introduce an error of approx. $0.1\Omega \sim 0.2\Omega$ for low resistance measurements. Use the Relative mode to obtain accurate readings. Short the test leads together, press the REL button, and then measure a low resistance. The meter subtracts the short-circuit value from the reading.
- If the test lead resistance of probe is > 0.5Ω when shorted, inspect the test leads and the connection.
- It may take several seconds for the reading to stabilize when measuring resistance > $1M\Omega$. This is normal operation.
- For personal safety, do not measure a circuit with voltages > 30V DC or AC.

5.11 Continuity Measurements

1. Insert the black test lead into the negative **COM** terminal and the red test lead into the positive terminal.
2. Set the function switch to the Ω with a speaker icon position.
3. Use the **MODE** button to select the Continuity mode (speaker icon).
4. Touch the test probe tips across the wire or circuit under test.
5. If the resistance is $< 10\Omega$, the beeper will sound continuously. If the resistance is between 10 and 100Ω the beeper may or may not sound. For an open circuit condition the meter will display **OL**.

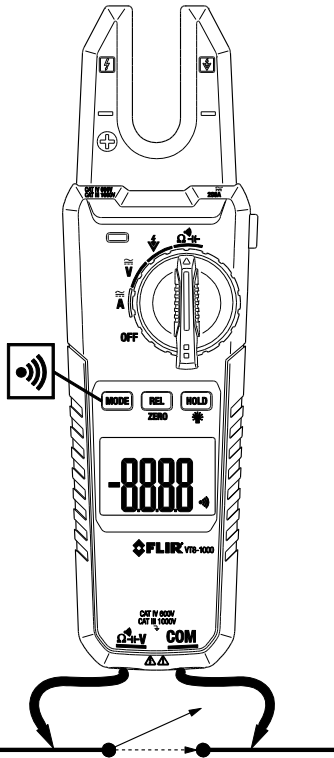

Fig 5-5 CONTINUITY MEASUREMENTS



Continuity Measurement Notes:

- Turn off power to the circuit under test and discharge capacitors before measuring continuity.
- Open-circuit voltage is approx. -3.5V
- Disconnect test leads and circuit measured after measurements are completed.

5.12 Capacitance Measurements

WARNING: To avoid electric shock, remove power to the circuit under test and discharge the capacitor under test before measuring. Do not test on circuits or devices where 60VDC or 30VAC is present.

1. Set the function switch to the Ω ⚡ position.
2. Insert the black test lead banana plug into the negative **COM** jack and the red test lead banana plug into the positive ⚡ jack.
3. Press **MODE** to select the capacitance function ⚡ .
4. Touch the test probe tips across the part under test.
5. For small capacitance values, use the **REL** button (Relative mode Δ) to remove test lead and probe capacitance.
6. Read the capacitance value in the display.
7. The display will indicate the proper decimal point and value.

Fig 5-6 CAPACITANCE MEASUREMENTS

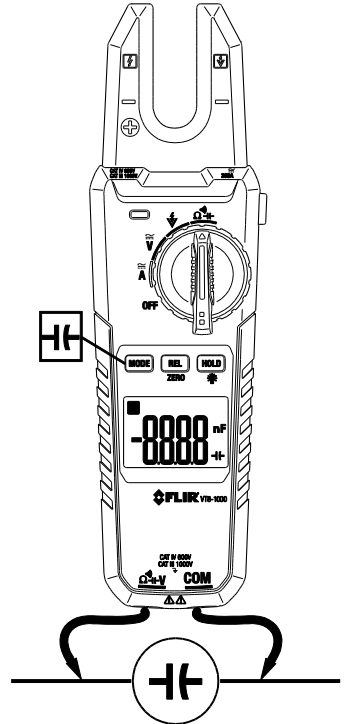

Capacitance Measurement Notes:

- The display will show "OL" if a capacitor is short circuited or if the measured capacitance > maximum range of the instrument.
- Capacitance measurements > 600 μ F may require several seconds to obtain a stable reading.
- In order to ensure measurement accuracy, discharge residual charges before measuring capacitance; Use maximum safety when working with high voltage capacitors to prevent damage to the instrument and risk to personal safety.
- Disconnect test leads and circuit under test after measurements are completed.

6. Maintenance



WARNING: To avoid electrical shock, remove the test leads, disconnect the meter from any circuit and turn OFF the meter before opening the case. Do not operate with an open case.

6.1 Battery Replacement

1. Turn meter OFF.
2. Remove the test leads from the meter.
3. Remove the Phillips head screw that secures the battery compartment cover on the back of the meter.
4. Open the battery compartment and replace the two AA batteries, observing correct polarity. Re-assemble the meter before use.

Battery Safety Notes: Please dispose of batteries responsibly; never dispose of batteries in a fire, batteries may explode or leak. If the meter is not to be used for 60 days or more, remove the batteries and store separately. Do not mix battery types or freshness levels; please use batteries of the same type and of the same freshness level.



Never dispose of used batteries or rechargeable batteries in household waste.

As consumers, users are legally required to take used batteries to appropriate collection sites, the retail store where the batteries were purchased, or wherever batteries are sold.

Disposal: Do not dispose of this instrument in household waste. The user is obligated to take end-of-life devices to a designated collection point for the disposal of electrical and electronic equipment.

6.2 Cleaning and Storage

Periodically wipe the case with a damp cloth and mild detergent; do not use abrasives or solvents. Please remove the batteries if the meter is stored for a long period of time.

7. Specifications

7.1 Electrical Specifications

Accuracy is given as \pm (% of reading + least significant digits) at 73.4 °F \pm 9 °F (23 °C \pm 5 °C) with relative humidity <80%. Accuracy is specified for a period of one year after calibration.

Function	Range	Resolution	Accuracy (reading)	'OL' Protection
AC Current	100A (VT8-600)	0.1A	\pm (2.5% + 5 digits)	100A (VT8-600)
	200A (VT8-1000)			200A (VT8-1000)
True RMS, Frequency Response 50 ~ 60Hz				
DC Current	100A (VT8-600)	0.1A	\pm (2.5% + 5 digits)	100A (VT8-600)
	200A (VT8-1000)			200A (VT8-1000)
Use the DC Zero function to null the display reading				
AC Voltage	6V	0.1V	\pm (1.2% + 2 digits)	600V (VT8-600) 1000V (VT8-1000)
	60V	0.1V	\pm (1.2% + 2 digits)	
	600V	0.1V	\pm (1.5% + 2 digits)	
	1000V (VT8-1000)	1V	\pm (1.5% + 3 digits)	
True RMS voltage applicable to 10% ~ 100% of the range Input Impedance: \geq 10M Ω ; Frequency response 45 ~ 66Hz				
DC Voltage	6V	0.1V	\pm (1.0% + 2 digits)	600V (VT8-600) 1000V (VT8-1000)
	60V	0.1V		
	600V	0.1V	\pm (1.0% + 2 digits)	
	1000V (VT8-1000)	1V	\pm (1.0% + 3 digits)	
Input Impedance: \geq 10M Ω				
Resistance	600.0 Ω	0.1 Ω	\pm (1.2% + 2 digits)	600V DC (VT8-600) 1000V DC (VT8-1000) 600V AC
	6.000k Ω	0.001k Ω	\pm (1.0% + 2 digits)	
	60.00k Ω	0.01k Ω		
	600.0k Ω	0.1k Ω		
	6.000M Ω	0.001M Ω	\pm (1.2% + 2 digits)	
	60.00M Ω	0.01M Ω	\pm (1.5% + 5 digits)	
Continuity	600.0 Ω	0.1 Ω	----	< 10 Ω beeper sounds. 10 Ω to 100 Ω undetermined. > 100 Ω beeper off (OL displayed). Open circuit voltage approx. 1.2V

Function	Range	Resolution	Accuracy (reading)	'OL' Protection
Capacitance	60.00nF	0.01nF	± (4.0% + 20 digits)	600V DC (VT8-600) 1000V DC (VT8-1000) 600V AC
	600.0nF	0.1nF		
	6.000µF	0.001µF		
	60.00µF	0.01µF		
	600.0µF	0.1µF		
	6.000mF	0.001mF	± (10%)	
	60.00mF	0.01mF	For reference only	
Non-Contact Volt Detector (NCV)	≥100Vrms; ≤10mm distance (LED/Buzzer alerts)			

7.2 General Specifications

Display	Backlit 6000-count (0 ~ 5999) multi-function LCD
Display update rate	3 times/second, approximately
Polarity	Automatic display of positive and negative polarity
Over-range indication	“OL” or “-OL” is displayed
Open Jaw Sensor Type	Hall Effect
Jaw opening	0.61” (15.5mm)
Electromagnetic field influence	Unstable or inaccurate readings may be displayed if there is an electromagnetic field disturbance in the measurement environment
Maximum Voltage	1000V AC rms/DC (VT8-1000) or 600V AC rms/DC (VT8-600) maximum applied to any terminal
Auto Power OFF	After 15 minutes
Operating Temperature	14 ~ 122°F (-10 ~ 50°C)
Storage Temperature	-22° ~ 140°F (-30° ~ 60°C)
Relative Humidity	95% maximum; 41 ~ 86°F (5 ~ 30°C) 75% maximum; 86 ~ 104°F (30 ~ 40°C) 45% maximum; 104 ~ 122°F (40 ~ 50°C)
Operating Altitude	6562' (2000m)
Battery power	2 x 1.5V 'AA' alkaline batteries
Low battery indication	 is displayed if batteries need replacing
Weight	10.6 oz. (300g), including batteries
Dimensions (W x H x D)	8.27x 2.1 x 0.67” (210 x 53 x 35mm)
Safety Standards	Complies with EN61010-1, EN61010-2-032, and EN61010-2-033 VT8-600: CAT III 600V, CAT IV 300V VT8-1000: CAT III 1000V, CAT IV 600V Pollution Degree 2 RCM, cULus, CE
Drop Protection	6.6' (2m) approx.
For Indoor Use	

8. Technical Support

Main Website	http://www.flir.com/test
Technical Support Website	http://support.flir.com
Technical support Email	TMSupport@flir.com
Service/Repair Support Email	Repair@flir.com
Support Telephone number	+1 855-499-3662 option 3 (toll-free)

9. Three-Year Limited Warranty

This product is protected by FLIR's 3-Year Limited Warranty. Visit www.flir.com/testwarranty to read the 3-Year Limited Warranty document. Register your product at the website to receive a free 1-year warranty extension.



Corporate Headquarters

FLIR Systems, Inc.
2770 SW Parkway Avenue
Wilsonville, OR 97070 USA
Telephone: +1 503-498-3547

Customer Support

Technical Support Website	http://support.flir.com
Technical Support Email	TMSupport@flir.com
Service and Repair Email	Repair@flir.com
Customer Support Telephone	+1 855-499-3662 option 3 (toll free)

Publication Identification No.:	VT8-600_1000
Release version:	AC
Release Date:	October 2018
Language:	en-US

Copyright © 2018 FLIR Systems, Inc.

All rights reserved including the right of reproduction in whole or in part in any form.

www.flir.com