

EasyView Light Meter with Memory

Model EA33

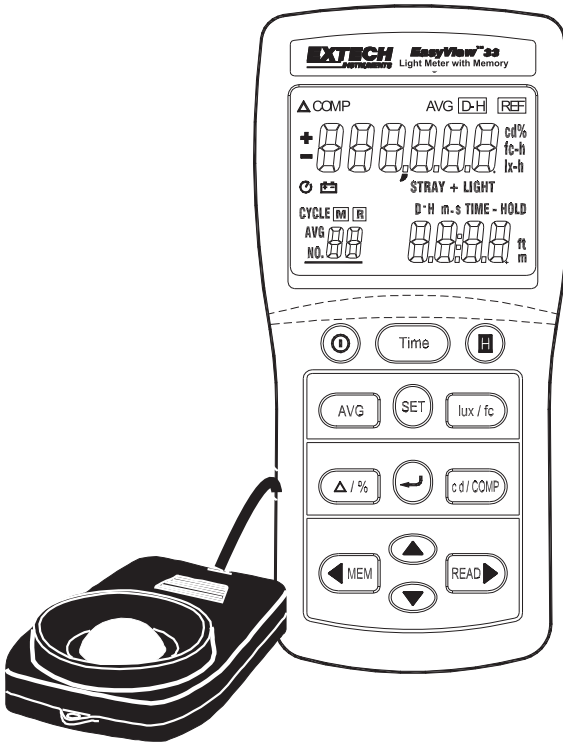

Introduction

Congratulations on your purchase of the Extech EA33 EasyView Light Meter which measures light level (luminance). This device measures up to 99,990 Fc and 999,990 Lux and stores up to 50 readings for easy recall. Careful use of this meter will provide years of reliable service.

Meter Description

1. Light measurement display
2. Timer display
3. TIME button
4. HOLD button
5. Unit of measure button (Fc/lux)
6. Enter button
7. Luminous Intensity (cd) / Comparator button
8. READ / Right arrow button
9. Average reading tally display
10. Power ON/OFF button
11. Set button
12. Average button
13. Relative / Percent button
14. Light sensor
15. Left arrow / Memory button
16. Up / Down arrow buttons

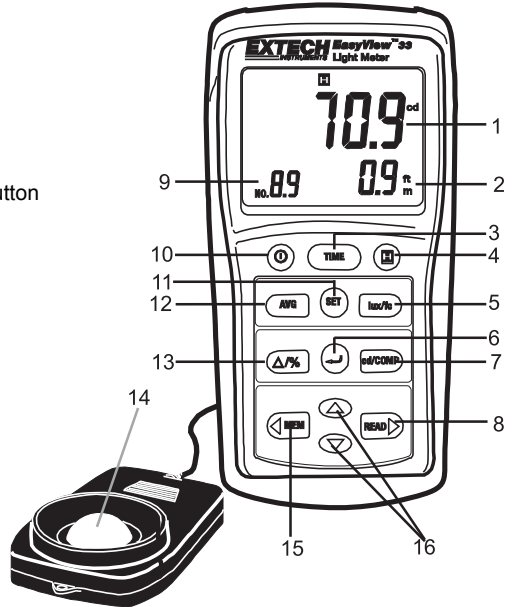

Display

1. Relative Mode
2. Comparator Mode
3. Average
4. Data Hold
5. % Relative
6. Candela
7. % Relative
8. fc/lx-hours Integral Illuminance
9. Stray light measurement
10. Time Hold measurement
11. ft/m Luminance intensity distance
12. Day-Hour minute-seconds
13. Memory Read
14. Memory location
15. Average Reading tally display
16. Integration cycles
17. Low battery
18. Elapsed time indicator

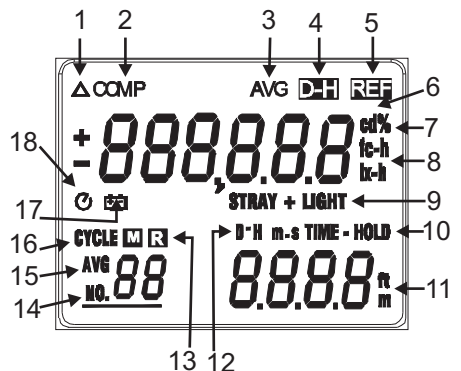

Basic Operation

1. With the sensor cover in place, press the  button to turn the meter on. The meter will perform a short self-test.
2. Remove the sensor's protective cap and place the sensor in the area to be measured.
3. Press the **lux / fc** button to select the desired units of measure.
4. Read the light level on the display. If the measurement is out of range, an "OL" indication will appear.
5. When the meter is turned on, the elapsed timer starts. The elapsed timer shows days/hours or minutes/seconds. Use the TIME button to toggle the view between minutes/seconds (M-S) and days/hours (D-H).



Operation Modes

In addition to the normal mode of operation where light level is measured, there are 5 special modes, listed below. Each mode is explained in the subsequent sections of this manual. The SET button is used to access the modes. The number on the lower left of the LCD (after the SET button is pressed) represents the mode currently selected. Use the down arrow key to scroll to the desired mode.

Programming modes		
Mode	Name of mode	Description
SEt 01	Stray+ Light	Cancels out stray light from light under test
SEt 02	Time - Hold	Meter measures while timer counts down. Reading is held on LCD when counter = 0.
SEt 03	rtC	Set the day and time for internal clock
SEt 04	Int	Lumen-seconds, lux-hour, and fc-hour measurements
SEt 05	COMP	Measurements are compared to high and low limits.

MODE 1 - Stray Light Inhibit

This feature allows the user to measure light from one source while automatically factoring out the light from a secondary (stray) unwanted source.

1. Turn on the desired light source and face the meter's sensor towards this source (the stray light source should be on also).
2. Press the SET key; 'SEt' and 'STRAY + LIGHT' will appear at the center of the LCD and '01' will appear on the lower left of the LCD (see diagram).
3. Press the ENTER key (). The measurement at this point consists of the primary AND the stray light sources (LIGHT + STRAY).
4. Press ENTER to store this value. STRAY will appear on the display
5. Turn off the primary light source.
6. Press the ENTER key again to store only the stray light source.
7. The meter will now compute and display the light level for only the desired (primary) light source. 'LIGHT' and 'DH' (Data Hold) will also appear on the display.
8. Press the ENTER key to exit this mode.



MODE 2 – Elapsed Timer with Hold

In this mode, measurements are made while the countdown timer is running. When the timer reaches zero, the last measurement is held on the display (see diagram).

1. Press the SET key; 'SEt 01' will display.
2. Press the down arrow key to change to the 'SEt 02' parameter. 'TIME-HOLD' will appear on the display.
3. Press the ENTER key to call up the timer.
4. Use the up/down arrow keys to set the desired seconds.
5. Press the ENTER key to program the number of minutes.
6. Use the up/down arrow keys to set the minutes.
7. Press the ENTER key to start the countdown timer. When the timer counts down, the last reading will be held on the display.
8. Press the ENTER key to exit this mode.

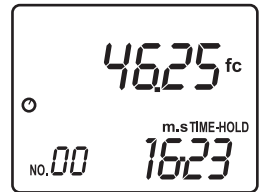

MODE 3 - Real Time Clock Setting

1. Press the SET key; 'SEt01' will display.
2. Press the down arrow key twice to select the 'SEt03' parameter. 'fc' will appear on the lower right of the LCD.
3. Press the ENTER key to enter the edit mode for 'seconds'.
4. Use the up/down arrow key to program the 'seconds'.
5. Repeat the previous two steps for the 'minutes', 'hours', and 'day' settings.
6. Press the ENTER key when finished.
7. Use the TIME key to toggle between minutes-seconds (m-s) and day-hour (D-H) views.

MODE 4 - Integral Illuminance Mode

Integral Illuminance is a luminous energy measurement based on the rate of flow of flux (expressed in lumen-seconds). The Model EA33 can also measure any photometric quantity on a time dependent basis. For example, the illuminance could be integrated over time to yield lux-hours (lx-h) or foot candle-hours (fc-h).

1. Press the SET key; 'SEt 01' will appear on the display.
2. Press the down arrow key three times to select the 'SEt 04' mode. 'int' will also appear on the LCD.
3. Press the ENTER key to start the Integral Illuminance measurement. The meter will set the first measurement as a reference. The 'lx-h' or 'fc-h' display icon will appear and the timer will start (the cycle number appears on the lower left of the LCD).
4. If measurements exceed the reference value, the display will freeze and the '+' symbol will appear. Note that the timer will also halt.
5. The maximum indication of integral illuminance is 999999. When this maximum is exceeded, the integration number (Cycle no. at lower left of LCD) can be checked. The maximum number of integration cycles is 99.
6. Press the ENTER key to exit this mode of operation.

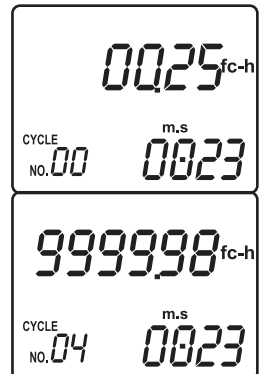

MODE 5 - Comparator Mode

In this mode the meter compares its measurements to one HIGH and one LOW limit. When the high limit is exceeded, the plus sign appears on the LCD. When the measurement falls below the low limit, the negative sign appears on the LCD.

1. Press the SET key; 'SET01' will appear on the display.
2. Press the down arrow key four times to select the 'SET05' parameter. 'COMP' appears.
3. Press the ENTER key to enter the Comparator setting mode.
4. Press the down arrow key to select the desired unit of measure (Lux or Fc).
5. Press ENTER to begin setting the measurement range.
6. Use the down arrow to select the desired range.
7. Press the ENTER key to begin setting the Comparator HIGH limit value. The '+' symbol will appear.
8. Use the up/down arrow keys to set the high limit value.
9. Press the ENTER key to begin setting the Comparator LOW limit value. The minus symbol will appear.
10. Use the up/down arrow keys to set the desired LOW limit value.
11. Press ENTER to complete the Comparator setup.
12. Press and hold the cd/COMP key for three seconds to activate the Comparator.
13. Now if a measurement exceeds the high limit, the plus sign will appear. If the low limit is exceeded, the minus sign will appear. An audible beep will sound when a limit has been reached.
14. Press the ENTER key to exit the Comparator mode.

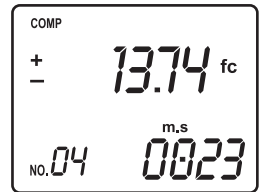

99-Point Averaging

Illuminance is the amount of visible light incident upon a specific surface area. Since the EA33 sensor area is small, the Average Mode can be used to measure the illuminance of larger surface areas; to accomplish this, up to 99 points can be averaged.

1. Press the AVG key. The 'AVG' display icon will appear.
2. Press the MEM key to store a reading (up to 99 readings can be averaged). The display at the lower left will keep a running tally of the readings recorded.
3. Press the READ key to perform the average calculation. The average value will be displayed and held on the LCD.
4. Pressing the MEM key at this point allows the meter to continuously average subsequent illuminance readings (the display will only show an average value).
5. Use the READ button to toggle between this continuous Average display and the normal measurement display.
6. Press the ENTER key to exit.

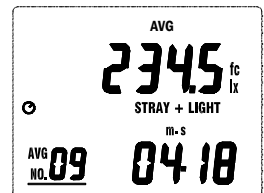

Luminous Intensity Feature

Luminous intensity is the measurement of light from a light source at a known distance from the sensor. The unit of measure is candela (cd).

1. Press the cd/COMP key to begin. The annunciator 'm' for meters (for lux measurement) or 'ft' for feet (for Fc measurement) will appear.
2. Use the up/down arrow keys to set the distance from the light source to the light sensor. The distance range is 0.01 to 9.99 meters or feet.
3. The measurement must be made in a dark room or in a room with no stray light.
4. The distance between the sensor and light source must be at least 10 times the size of the light source.
5. Press the ENTER key to perform the luminous intensity measurement. The 'cd' (for candela) units icon will appear along with the reading.
6. Press the ENTER key again to exit.



Data Record/Recall

MEMORY CLEAR

1. Turn off the meter.
2. Press and hold the MEM key while turning on the meter. Release the MEM key when the display reads 'CLr' indicating that the memory banks have been cleared (erased).

MANUAL DATA RECORD

1. Each time the MEM key is pressed with the meter turned on, a data record is recorded. The display will show 'M' and an audible tone will sound.
2. The counter on the lower left of the LCD will show the number of stored readings.
3. The total memory size is 50 records.

READING STORED RECORDS

1. Press the READ key to enter the memory recall mode. The display will show 'R' and the address number for the displayed data point.
2. Use the up/down arrow keys to scroll through the stored readings.
3. Press the ENTER key to exit this mode of operation.

AUTO POWER OFF Feature

To conserve battery life, the EA33 automatically turns off after several minutes. To defeat this feature:

1. Turn the meter OFF.
2. Press and hold the HOLD key while turning the meter ON.
3. The AUTO POWER OFF feature will now be disabled.
4. Note that AUTO POWER OFF is re-enabled each time the meter is turned on.
5. Also note that AUTO POWER OFF is always disabled in the Integral Illuminance mode.

Maintenance

Cleaning and storage

1. The white plastic sensor dome should be cleaned with a damp cloth when necessary.
2. Store the meter in an area with moderate temperature and humidity (refer to the operating and storage range in the specifications chart earlier in this manual).

Battery Replacement

When the battery power falls low, the battery symbol will appear on the lower left-hand side of the LCD. Replace the six (6) 1.5 'AAA' batteries by removing the rear (center) battery compartment screw and accessing the battery compartment. Observe polarity when placing the batteries in the compartment. Ensure that the compartment cover is securely fastened when finished.



You, as the end user, are legally bound (**EU Battery ordinance**) to return all used batteries, **disposal in the household garbage is prohibited!** You can hand over your used batteries / accumulators at collection points in your community or wherever batteries / accumulators are sold!

Disposal: Follow the valid legal stipulations in respect of the disposal of the device at the end of its lifecycle

Specifications

Ranges	Resolution	Accuracy
Lux		
99.99	0.01	± (3% reading + 0.5%FS)
999.9	0.1	
9999	1	
99990	1	± (3% rdg + 5 digits)
999900	1	± (3% rdg + 0.5%FS)
Foot candles		
9.999	0.001	± (3% reading + 0.5%FS)
99.99	0.01	
999.9	0.1	
9999	1	± (3% rdg + 5 digits)
99990	1	± (3% rdg + 0.5%FS)

Note: Calibrated to a standard incandescent lamp at color temperature of 2856°K

General Specifications

Display	Multi-function LCD with a maximum display of 999900
Ranging	Autoranging over five ranges
Over range indication	LCD displays 'OL'
Spectral response	CIE photopic (CIE human eye response curve)
Spectral accuracy	$V\lambda$ function ($F_1 \leq 6\%$)
Cosine response	$F_2 \leq 2\%$; Cosine corrected for angular incidence of light
Measurement Repeatability	$\pm 2\%$
Temperature coefficient	$\pm 0.1\%$ per °C
Sampling rate	5 times per second
Photo detector	Silicon photo-diode with spectral response filter
Operating conditions	Temperature: 0 to 40°C (32 to 104°F); Humidity: < 80%RH
Storage conditions	Temperature: -10 to 50°C (14 to 140°F); Humidity: < 80%RH
Meter Dimensions	150 x 72 x 35mm (5.91 x 2.8 x 1.4")
Detector Dimensions	92 x 60 x 29mm (3.6 x 2.4 x 1.5")
Weight	Approx. 11.3 oz. (320g) with battery
Sensor lead length	150cm (5')
Low battery indication	Battery symbol appears on the LCD
Power supply	Six (6) 'AAA' cells
Battery life	200 hours (approx.)

Copyright © 2013 FLIR Systems, Inc.

All rights reserved including the right of reproduction in whole or in part in any form

ISO-9001 Certified

www.extech.com

Appendix

Typical Light Levels

Lux	Foot Candles		Lux	Foot Candles	
		Factories			Home
20-75	2-7	Emergency Stairs, Warehouse	100-150	10-15	Washing
75-150	7-15	Exit/Entrance Passages	150-200	15-20	Recreational Activities
150-300	15-30	Packing Work	200-300	20-30	Drawing Room, Table
300-750	30-75	Visual Work: Production Line	300-500	30-50	Makeup
750-1,500	75-150	Typesetting: Inspection Work	500-1,500	50-150	Reading, Study
1,500-3,000	150-300	Electronic Assembly, Drafting	1,000-2,000	100-200	Sewing
		Office			Restaurant
75-100	7-10	Indoor Emergency Stairs	75-150	7-15	Corridor Stairs
100-200	10-20	Corridor Stairs	150-300	15-30	Entrance, Wash Room
200-750	20-75	Conference, Reception Room	300-750	30-75	Cooking Room, Dining Table
750-1,500	75-150	Clerical Work	750-1,500	75-150	Show Window
1,500-2,000	150-2000	Typing, Drafting			
		Store			Hospital
75-150	7-15	Indoors	30-75	3-7	Emergency Stairs
150-200	15-20	Corridor/Stairs	75-100	7-10	Stairs
200-300	20-30	Reception	100-150	10-15	Sick Room, Warehouse
300-500	30-50	Display Stand	150-200	15-20	Waiting Room
500-750	50-75	Elevator	200-750	20-75	Medical Exam Room
750-1,500	75-150	Show Window, Packing Table	750-1,500	75-150	Operating Room
1,500-3,000	150-300	Storefront, Show Window	5,000-10,000	500-1000	Eye Inspection

Spectral Sensitivity

