

# User Manual



## Thermocouple Thermometer with Four Type K/J Inputs and Data Logging

with NIST-Traceable Calibration

### Model 20250-03

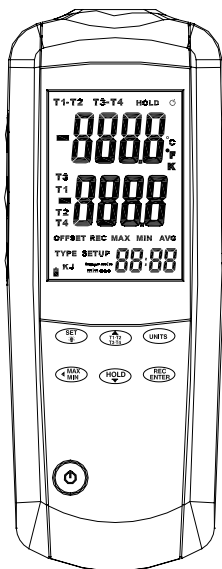

THE STANDARD IN PRECISION MEASUREMENT

## **Introduction**

The Digi-Sense Thermocouple Thermometer with Four Inputs and Data Logging (Model 20250-03) offers fast response and high accuracy. This thermometer accepts four thermocouple sensors (type K or J). Advanced features include data logging, USB interface, relative time clock, offset compensation, temperature differential, data Hold, Max/Min/Avg readings, and auto power-off. The instrument is fully tested and calibrated to NIST-traceable standards. Careful use of this meter will provide years of reliable service.

## **Unpacking**

Check individual parts against the list of items below. If anything is missing or damaged, please contact your instrument supplier immediately.

1. Meter
2. Four type K flexible probes
3. USB cable
4. Software
5. Three AAA batteries
6. User manual
7. NIST-traceable calibration report with data

## **Key Features**

- Large backlit display shows any combination of T1, T2, T1–T2, T3, T4, T3–T4; plus Max, Min, and Avg readings
- Relative time clock on Max/Min/Avg provides a time reference for major events
- Electronic Offset function allows compensation of thermocouple errors to maximize overall accuracy
- USB interface
- Data logging capacity of 18,000 sampling points
- User-selectable readout in °C, °F, or Kelvin (K)
- Automatic power-off (sleep) mode to conserve battery life
- Four sensor inputs; accepts a wide variety of type K and type J thermocouple probes

## Meter Description

1. Temperature sensor inputs (4)
2. LCD
3. SET /  backlight button
4. ▲(Up)/T1-T2/T3-T4 button
5. Units (°C/°F/K) button
6. ◀ (Return)/Max/Min button
7. Hold/▼(Down) button
8. Rec/Enter button
9. Power on/off button

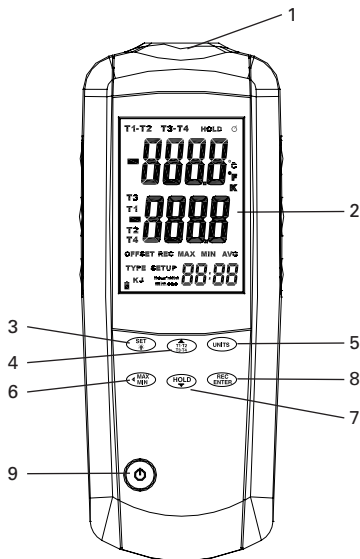

## Display Layout

1. T1, T2, T1-T2, T3, T4, and T3-T4 icons
2. HOLD icon
3. Auto power-off icon
4. Primary temperature display
5. User-selectable temperature units (°C/°F/K)
6. Secondary display (Max, Min, Avg, Offset, or T1 to T4 readings)
7. MAX, MIN, AVG icons
8. Tertiary display (elapsed time)
9. Time icon (hour:min or min:sec)
10. SETUP mode icon
11. Low-battery indicator
12. Thermocouple type icon (K or J)
13. OFFSET icon
14. REC icon (data logging)

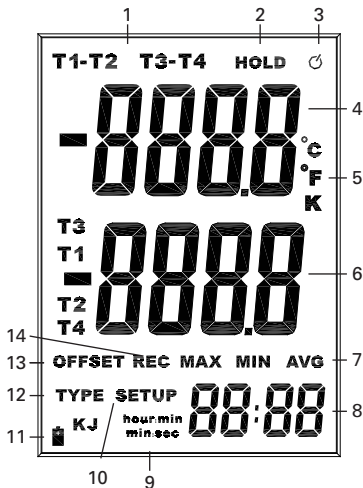

## **Setup and Operation**

1. Press **Power on/off** button to turn the unit on. The value immediately shown is the number of data logging sample points remaining (from 18,000 to 0). After one second, the display will then switch to the temperature measurement reading mode.
2. Press **Rec/Enter** button for three seconds to start recording and press again for three seconds to stop recording. When the thermometer is in Setup mode, press **Rec/Enter** button to enter a setup option and press **Rec/Enter** button again to store the displayed setting in memory.
3. Press **▲/T1-T2/T3-T4** button to toggle showing the T1, T2, and T1-T2 (differential temperature) measurements or the T3, T4, and T3-T4 (differential temperature) measurements in the primary and secondary displays. Press and hold **▲/T1-T2/T3-T4** button for three seconds to toggle showing the T1, T2, T3, or T4 values in the primary and secondary displays. When the meter is in Setup mode, press **▲/T1-T2/T3-T4** button to scroll to the Setup option you want to change or press **▲/T1-T2/T3-T4** button to increase the displayed setting.
4. Press **Units** button to switch between Celsius (°C), Fahrenheit (°F), and Kelvin (K).
5. Press **Hold/▼** button to freeze or unfreeze the displayed readings. When the meter is in Setup mode, press **Hold/▼** button to scroll to the Setup option you want to change or press **Hold/▼** button to decrease the displayed setting.

6. Press **◀/Max/Min** button to step through the maximum, minimum, and average readings. To exit the Max/Min/Avg mode, press and hold **◀/Max/Min** button for three seconds to return to normal operation.
7. Press **Set/backlight** button to turn the backlight on and off. Press and hold the **Set/backlight** button for three seconds to enter or exit the Setup mode. (See "Changing Setup Options, APO/Sleep Mode" on page 12.)

## **Setup Mode**

Use the Setup mode to change offset, sample rate, time, clear data logging memory, and sleep mode settings. The meter stores the settings into its memory.

<b>Option</b>	<b>Menu item</b>	<b>Settings</b>
Offset	T1, T2, T3, T4	T1 , T2, T3, T4 offset
Sample rate	rAt	Sampling of recording
Time setting	tiE	Show the time or set the time
Clear data logging memory	CLR	Clear the memory operation
Sleep mode	SLP	On (sleep mode on) OFF (sleep mode off)

### **Entering or Exiting Setup Mode**

When the meter is in Setup mode, the display shows the **SETUP** icon. Press and hold **SET** button for three seconds to enter or exit the Setup mode.

## Changing Setup Options

1. Press **▲/T1–T2/T3–T4** button or **Hold/▼** button to scroll to the Setup option you want to change.
2. Press **Rec/Enter** button to indicate that you want to change this setting.
3. Press **▲/T1–T2/T3–T4** button or **Hold/▼** button until the setting you want to use appears on the display.
4. Press **Rec/Enter** button to store the new setting into memory.

**Note:** Setup is disabled in the Max/Min and Rec/Enter modes.

## Offset Function

The primary display shows the temperature plus the offset and the secondary display shows the offset. You can store individual offsets for T1, T2, T3, and T4.

1. When the meter is in Setup mode, the display shows the **SETUP** icon. Press **▲/T1–T2/T3–T4** button or **Hold/▼** button to scroll to the **T1 offset setup** option screen (Fig 1).
2. Press **Rec/Enter** button to access the T1 offset value shown in the secondary display.
3. Use **▲/T1–T2/T3–T4** or **Hold/▼** button until the setting you want to use appears on the display.

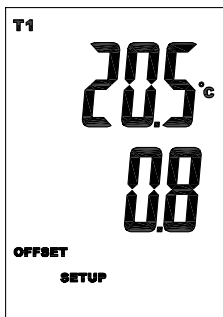

Fig.1

4. Press **Rec/Enter** button to store the new setting into memory and continue to T2, T3, and T4 offsets.



## Using the Offset to Adjust for Probe Errors

Use the offset option in the Setup mode to adjust the meter's readings to compensate for the errors of a specific thermocouple. The allowable adjustment range is  $\pm 9.00^{\circ}\text{F}$  or  $\pm 5.00^{\circ}\text{C}$ .

1. Plug the thermocouple into the input connector.
2. Place the thermocouple in a known, stable temperature environment (such as an ice bath).
3. Allow the readings to stabilize.
4. In the Setup mode, change the offset until the primary reading matches the calibration temperature. (See "Changing Setup Options" on page 8.)

## Sample Rate of Data Recording

1. Press and hold SET button for three seconds to enter the Setup mode. While in Setup mode, the display shows the **SETUP** icon.
2. Use the **▲/T1-T2/T3-T4** and **Hold/▼** buttons to scroll to the **rAt** option screen (Fig. 2).
3. Press **Rec/Enter** button to access the "00:01" (minute, second) value shown in the tertiary display (Fig. 2).
4. Press **◀/Max/Min** button until the **minute** value is flashing. Use the **▲/ T1-T2/T3-T4** and **Hold/▼** buttons to set the desired value.



Fig. 2

## Sample Rate of Data Recording (continued)

5. Press ◀/Max/Min button again until the **second** value is flashing. Use the ▲/T1-T2/T3-T4 and Hold/▼ buttons to set the desired value.
6. Press **Rec/Enter** button to store the new setting into memory.
7. **Note:** When the meter is powered down, the default sample rate is the last setting.

## Time Setting Function

1. Press and hold **SET** button for three seconds to enter the Setup mode. While in Setup mode, the display shows the **SETUP** icon.
2. Use the ▲/ T1-T2/T3-T4 and **Hold/▼** buttons to scroll to the **time** setting option screen (Fig. 3).
3. Press **Rec/Enter** button to access the values (Fig. 4). The primary display shows the year, the secondary display shows the month and day, the tertiary display shows the hour and minute.
4. Press ◀/Max/Min button until the **year** value is flashing. Use the ▲/ T1-T2/T3-T4 and **Hold/▼** buttons to set the desired value.
5. Press ◀/Max/Min button again until the **month** value is flashing. Use the ▲/T1-T2/T3-T4 and **Hold/▼** buttons to set the desired value.

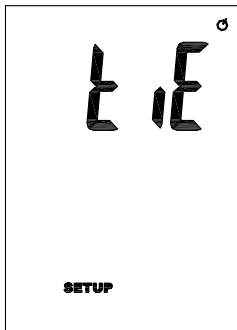

Fig. 3

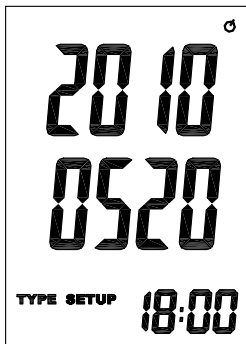

Fig. 4

6. Press ◀/Max/Min button again until the **day** value is flashing. Use the ▲/ T1–T2/T3–T4 and Hold/▼ buttons to set the desired value.
7. Press ◀/Max/Min button again until the **hour** value is flashing. Use the ▲/ T1–T2/T3–T4 and Hold/▼ buttons to set the desired value.
8. Press ◀/Max/Min button again until the **minute** value is flashing. Use the ▲/ T1–T2/T3–T4 and Hold/▼ buttons to set the desired value.
9. Press **Rec/Enter** button to store the new setting into memory.

### Clear Memory Operation

Immediately after turning on the meter, the first value shown is the number of data logging sample points remaining (from 18,000 to 0). Once the memory is full, the first value shown will be “FULL” rather than a number. Or if you try to record, the **REC** icon will flash five times and disappear. At this point, you are no longer able to record until the memory is cleared.

1. Press and hold **SET** button for three seconds to enter the Setup mode. While in Setup mode, the display shows the SETUP icon.
2. Use the ▲/T1–T2/T3–T4 and Hold/▼ buttons to scroll to the **CLR memory** option screen (Fig. 5). The screen indicates the number of sample points remaining.



Fig. 5 Screen shows 17,985 readings left in memory.

## Clear Memory Operation (continued)

3. Press **Rec/Enter** button and “No” appears on the screen. (Fig. 5)
4. Press **▲/ T1–T2/T3–T4** button or **Hold/▼** button until the display shows “YES”, indicating the memory will be cleared.
5. Press **Rec/Enter** button to select the “YES” setting and clear the memory. Data logging capacity now returns to 18,000 sample points.

## Auto Power-Off (APO)/Sleep Mode

The meter’s default mode is to automatically shut off after 15 minutes of non-use. To disable the auto power-off mode, enter the Setup mode.

1. While in Setup mode, press **▲/T1–T2/T3–T4** or **Hold/▼** button to scroll to the “SLP” option screen (Fig. 6).
2. Press **Rec/Enter** button to display “On.”
3. Use the **▲/T1–T2/T3–T4** and **Hold/▼** buttons to toggle between “On” (sleep mode on) or “Off” (sleep mode off).
4. **Note:** Meter defaults back to “On” once meter is powered off.

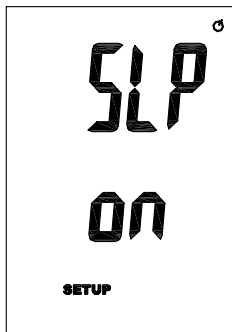

Fig. 6

## Measuring Temperatures

1. Plug the thermocouple(s) into the T1, T2, T3, or T4 input connector(s). Make sure that the polarity is correct.
2. Press **Power on/off** button to turn the unit on. The value immediately shown is the number of data logging sample points remaining (from 18,000 to 0). After one second, the display will then switch to the first temperature measurement reading.

**Note:** If no thermocouple is plugged into the selected input or the thermocouple is not connected properly, the display shows "- - - ". If the temperature being measured is outside the thermocouple's valid range, the display shows "OL" (overload).

3. Set the thermometer for the correct thermocouple type (K or J) in the Setup menu.
4. Press the **Unit** button to select the desired temperature scale (°C, °F, or K).
5. Press **▲/T1-T2/T3-T4** button to toggle between showing the T1, T2, and T1-T2 readings in the primary or secondary display.
6. Press and hold **▲/T1-T2/T3-T4** button for three seconds to bring up the T3, T4, and T3-T4 readings. Then press **▲/T1-T2/T3-T4** button again to toggle between showing the T3, T4, and T3-T4 readings in the primary or secondary display.
7. Press and hold **▲/T1-T2/T3-T4** button for three seconds to return to the T1, T2, and T1-T2 readings.

## Hold Function

1. Press **Hold/▼** button to freeze the readings on the display. The display shows the **HOLD** icon.
2. Press **▲/T1-T2/T3-T4** button to toggle between showing the T1, T2, and T1-T2 readings in the primary or secondary display.
3. Press and hold **▲/T1-T2/T3-T4** button for three seconds to bring up the T3, T4, and T3-T4 readings. Then press **▲/T1-T2/T3-T4** button again to toggle between showing the T3, T4, and T3-T4 readings in the primary or secondary display.
4. Press and hold **▲/T1-T2/T3-T4** button for three seconds to return to the T1, T2, and T1-T2 readings.
5. Press **Hold/▼** button again to turn off the Hold function.

## Max/Min/Avg Functions

1. Press **◀/Max/Min** button to step through the maximum (MAX), minimum (MIN), and average (AVG) readings. The elapsed time since entering MAX/Min mode, or the time at which the maximum or minimum reading occurred, appears on the display.
2. Press and hold **◀/Max/Min** button for three seconds to exit MAX/MIN mode.

## Recording/Data Logging Operation (Meter)

1. Press **Power on/off** button to turn the unit on. The first value immediately shown is the number of data logging sample points remaining. (Fig. 7)
2. Press and hold **Rec/Enter** button for three seconds until the **REC** icon appears. The meter is now data logging temperature readings.
3. Press and hold **Rec/Enter** button again for three seconds to stop data logging function.
4. **Note:** A maximum of 18,000 sample points is available (Fig. 7). As you log temperature readings, this value will be lower each time you turn the meter. When the memory is full (with 0 sample points remaining), the first value shown will be "FULL" rather than a number. Or if you try to record, the REC icon will flash five times and disappear. At this point, you are no longer able to record until the memory is cleared. (See "Changing Setup Options", "Clear Memory Operation" on pages 11–12.)

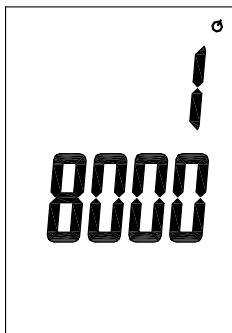

Fig. 7 Screen shows 18,000 readings left in memory.

## Recording/Data Logging Operation (Software)

1. First install software on PC following the setup wizard (see “Software Installation” on next page). Once software is successfully installed, the “MultiDL” software icon shortcut will be automatically placed on your PC desktop.
2. Connect the meter to your PC via the supplied USB cable.
3. Power the meter on.
4. Open the installed Multi Data Logger Software by double clicking on the “MultiDL” icon on your PC desktop.
5. When opened, double click on the image of the meter located in the left-hand white pane box. This will activate the image of the meter’s screen to illuminate.
6. On the menu bar, select the PC image icon (when mouse is dragged over the icon, it is titled “Data Logger Setting”).
7. In the Data Logger Setting menu confirm time and select date format, sampling rate, memory full directions, auto power-off status, and start method, then select “OK”.  
**You must set these parameters before meter will record measurements.**
8. **Note:** Manual start method is controlled by pressing **Rec/Enter** button on the meter. Automatic start method will instantly activate recording via the software once selected.
9. In manual record mode, press and hold **Rec/Enter** button on the meter for three seconds until the **REC** icon is displayed on the screen. This will indicate that recording function has been activated. Upon completion of desired data logging of measurements, press and hold **Rec/Enter** button for three seconds until the **REC** icon disappears from the screen, indicating data logging has been deactivated.



10. To download the data to the PC, select the downward facing arrow in menu bar in the software window. The software screen will display the data being downloaded from the meter. Upon completion of downloading the data to the PC, the data results will be displayed graphically.
11. To save the measurement data to your PC select the "Data List" tab to open the list of measurements recorded. Select "File" icon from the menu bar and save data to desired location on your PC. **Note:** Data will be saved in an Excel® format that will include all summary information as captured on the "Data Summary" tab.
12. To print recorded data, simply select the "print" icon on the menu bar.

## **Software Installation**

1. Insert the CD into the PC.
2. Double click the set up.exe file to launch the software installation program.
3. Follow the installation wizard to complete the installation.
4. If the USB driver needs to be updated or driver error message is received, please go to the folder with driver on the CD and double click the file CP210xVCPInstaller.exe to update the driver.
5. Upon successful installation of the software, the "MultiDL" software icon shortcut will be automatically placed on your PC desktop.

## **Specifications**

<b>Range</b>	
Type K thermocouple(s)	-328 to 2501°F (-200 to 1372°C)
Type J thermocouple(s)	-346 to 2012°F (-210 to 1100°C)
<b>Resolution</b>	
Temperature display	0.1 below 1000 or 1 above 1000
<b>Accuracy</b>	
T1, T2, T3, T4 temperatures above -148°F (-100°C)	±[0.5% rdg + 1.8°F (1°C)]
T1, T2, T3, T4 temperatures below -148°F (-100°C)	±[0.5% rdg + 3.6°F (2°C)]
T1-T2, T3-T4 temperature differentials	±[0.5% rdg + 3.6°F (2°C)]

Auto power-off	Unit shuts off automatically after 15 minutes to preserve battery life
Operating temperature	32 to 122°F (0 to 50°C)
Storage temperature	14 to 122°F (-10 to 50°C)
Weight	6.2 oz (177 g)
Dimensions	6½" x 2½" x 1⅛" (16.5 x 6.4 x 2.9 cm)
Power	Three AAA batteries

## **Maintenance, Recalibration, and Repair**

### **Cleaning and storage**

- The meter should be cleaned with a damp cloth and mild detergent when necessary. Do not use solvents or abrasives.
- Store the meter in an area with moderate temperature and humidity (refer to the operating and storage ranges in the specifications chart earlier in this manual).

### **Battery Replacement**

When the battery power falls low, the low-battery icon will appear on the screen. Replace the three AAA batteries by removing the screw holding the rear battery compartment cover to access the battery compartment. Ensure that the compartment cover is securely fastened when finished.

**Note:** If you do not intend to use the meter for a long time, remove the batteries.

**It is recommended that Digi-Sense products are calibrated annually** to ensure proper function and accurate measurements; however, your quality system or regulatory body may require more frequent calibrations.

## **For Product and Ordering Information, Contact:**

Contact:  
Industrial Process Measurement, Inc.  
3910 Park Avenue, Unit 7  
Edison, NJ 08820  
732-632-6400  
support@instrumentation2000.com  
<http://www.instrumentation2000.com>