

nVision Operation Manual

for Reference Recorder & Lab Reference



Contents

Overview	1	Absolute Pressure Specifications25
Introduction.....	.1	Current, Voltage, and Switch Test (MA20) Module Instructions26
Quickstart.....	.2	Current, Voltage, and Switch Test (MA20) Module Specifications28
Functions	3	Temperature (RTD100) Module Instructions30
On/Off.....	.3	Temperature (RTD100) Module Specifications33
Measurements & Recording3	Resistance Temperature Detectors (RTD)34
Numerical Display Overview5	Power	36
Graphical Display Overview5	Battery Power (Reference Recorder only)36
Graphing6	USB Power (Reference Recorder only)38
Averaging Mode7	Reset (Reference Recorder only).....	.38
Differential Mode7	Safety and Certifications	39
Run Tags.....	.8	Hazardous Locations39
Chassis	9	Certifications39
Chassis Controls9	Multi-language Safety Instructions42
Serial Numbers13	Support	47
nVision Reference Recorder Specifications14	Troubleshooting47
nVision Lab Reference Specifications15	Calibration49
Modules	16	Accessories and Replacement Parts50
Module Installation Instructions.....	.16	Contact Us51
Pressure Module (PM) Instructions18	Trademarks51
Pressure Module (PM) Specifications19	Warranty.....	.51
Barometric Reference (BARO) Module Instructions23		
Barometric Reference (BARO) Module Specifications24		

Overview

INTRODUCTION

Thank you for choosing the nVision Reference Recorder from Crystal Engineering Corporation. The philosophy behind nVision:

nVision lets you visualize measurements graphically, with or without a pc, in real time as it is being recorded. It is much easier to identify trends or anomalies visually, than in tables of data or spreadsheets.

nVision is tremendously flexible and can be configured to measure and record a variety of combinations of measurements. In addition to pressure, modules for temperature, voltage and current can be used.

Because all of these inputs can be displayed individually as numbers or as graphs, or in combination with other inputs (numerically and graphically) we also provide a way to simplify nVision, so you can limit the available screens to only those that are of use to your specific task.

Accuracy is up to 0.025 percent of reading—so any nVision can typically replace several gauges or calibrators you may have been using. The nVision is fully temperature compensated—so there is no change in accuracy throughout the entire operating temperature range!

The nVision features two identical bays allowing configuration of the reference recorder to meet your requirements. All modules are field-replaceable allowing you the flexibility to react to changing needs and module calibration requirements.

The nVision's case is made from a rugged injection molded polymer utilizing a gasket to seal the enclosure against dust and water intrusion. Even the mini USB B connector is fully sealed (with or without the protective boot cover). Circuitry is mounted in a shock-absorbing elastomeric system and the batteries are easily accessible by removing four captive screws.

Other features include:

- Log and display 500,000 points at up to 10 readings per second on up to two modules simultaneously
- Interactive real-time graphing of measurements
- ATEX / IECEx Scheme intrinsically safe (nVision Reference Recorder only)
- IP67 rated enclosure —1 meter immersion for 30 minutes (nVision Reference Recorder only)
- Uses Crystal's CPF[♦] fittings and hose system (leak-free and finger-tight to 10 000 psi (700 bar)) [♦]U.S. Patent No. 8,794,677

We hope your nVision meets your expectations, and we're interested in any comments or suggestions you may have. You can send us a note at: crystal@ametek.com. Many features in this and our other products are a direct result of your comments!

Crystal Engineering is the company that designs, manufactures, and services the nVision reference recorders, XP2i series pressure gauges, 30 series pressure calibrators, MultiCal multimeter pressure modules, and a variety of industry specific pressure measuring equipment.

Crystal Engineering pioneered features like full temperature compensation and "of reading" rated gauges and calibrators. Pressure measuring equipment is the only thing we do and that's why we say:

 Pressure is our Business™

Your nVision can be customized to meet your specific test needs through the use of CrystalControl™ software. Your personal computer can disable, enable, or modify a variety of features of your nVision. Look for the  logo for user programmable features, like:

- User defined pressure units, and/or disable unused pressure units
- Password protection to prevent unauthorized changes to gauge settings and/or product keypad access
- Expand or decrease allowable Zero range
- Set the gauge to a different density of water factor (4°C, 60°F, or 68°F)
- Store custom ID or tag numbers in non-volatile memory
- Adjust calibration values

CrystalControl is included with your nVision, and is also available as a download from our website at ametekcalibration.com.

QUICKSTART

nVision Reference Recorder shown.
All instructions on this spread are also applicable to nVision Lab Reference

Power Icon Key - nVision Reference Recorder

Icon							
Description	External Power (USB)	Power Remaining					

* Replace Batteries or connect to USB Power

Power Icon Key - nVision Lab Reference

Icon			
Description	External Power (AC Adapter)	USB Connection	

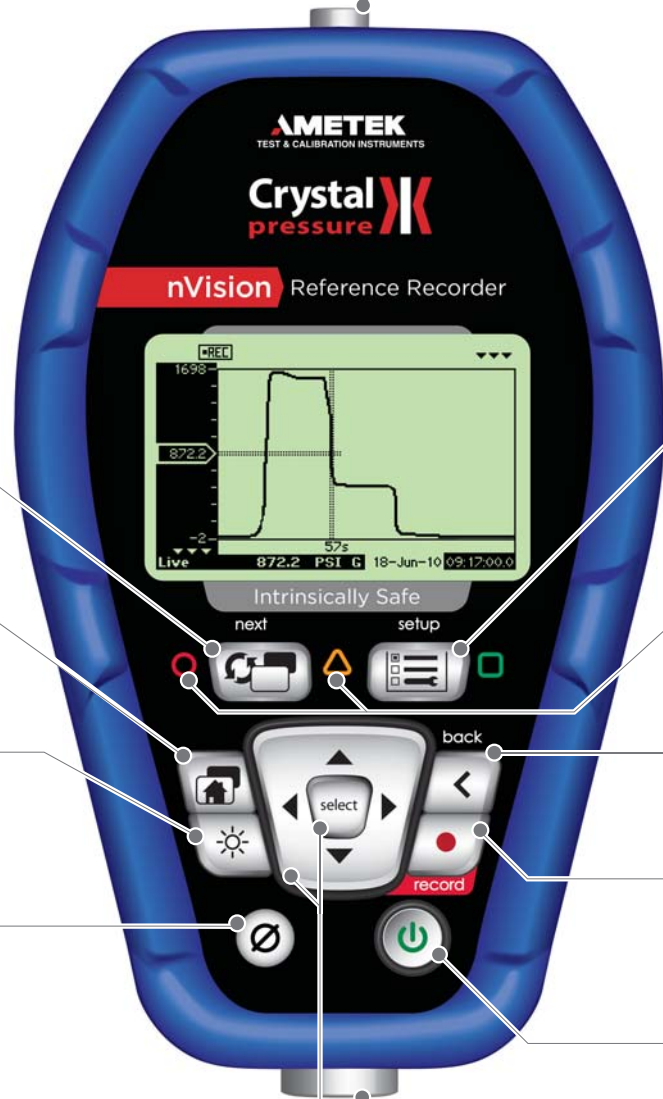

Next button:
Progress through the display screens

Home button:
Brings you back to the default screen
 (Change Home Screen)

Backlight button:
Turn on/off display backlight
 (Adjust Backlight Shutoff)

Zero button:
Press to zero Pressure Module reading (----)
Hold for 5 seconds to clear any zero value (---)
 (Adjust Zero Limit)

Navigation & Select

Upper Module Bay

Setup Button:
Locate additional features:

- Clear Peaks
- ▼ Units (Adjust Available units)

 - PM Mode: Gauge or Absolute

- ▼ Settings
 - Contrast
 - Lock/Unlock Chassis
- ▼ Summary
 - Chassis, Upper, Lower
- ▼ Recording
 - Start/Stop
 - Erase All Runs

LED Indication alerts:

- : Flashes while recording
(Flashes quickly when recording ends)
- : Flashes when a module's range is exceeded

Back button:
Previous Display Screen

Record button:
Start/Stop data recording
(Adjust Logging Interval)

Power button:
Turn your nVision on/off

Lower Module Bay

This icon represents a component that can be modified with CrystalControl software

Functions

ON/OFF

Power button

Press and hold the (power) button for 1 second to turn the nVision on or off. The nVision will automatically power down if not used for the time period defined in CrystalControl.

Automatic Shutoff - Low Power Mode

 Adjust your *Automatic Shutoff* time (shut off time in absence of key press) to optimize battery life. This feature is adjustable from 30 seconds to “always on.” During a recording, the nVision will enter *Low Power Mode* instead of shutting off.

When powered by USB, the nVision does not employ any power management strategies. Therefore, it will not automatically shut off to the settings defined by CrystalControl.

During a recording with a Logging Interval of 1 reading/minute or slower, your nVision will enter *Ultra-Low Power Mode* after the first reading elapses *and* the Automatic Shutoff Timer runs out.

The Backlight Shutoff is set separately in CrystalControl. It is unaffected by other settings.

MEASUREMENTS & RECORDING

Recording

The nVision can record at rates from 10 readings per second to 1 reading per hour as set in CrystalControl. Adjust your recording rate to optimize battery life and data recording space.

 Your nVision is capable of recording more than 500,000 data points when both module bays are populated. With one bay populated, this number doubles. CrystalControl will give you a more accurate view of recording times based on the logging rate and enabled screens for your nVision.

When connected to CrystalControl you can configure, control, and graph an nVision recording directly from your PC, without handling the nVision chassis.

To *start* or *stop* a recording run from any screen:

1 Press the (record) button for one second.

Note:  You may be prompted to enter a Run Tag, if enabled. For more information, see [Run Tags](#).

2 The red LED will start flashing when the recording begins.

3 To *stop* recording, press the (record) button again. The red LED will flash twice.

Note:  The nVision records data for all screens enabled in Crystal Control. Even if you are viewing data for the lower module numerical display, data for the upper module will still record if any of the screens for that module are enabled. Use CrystalControl to check which data screens are enabled.

Ø Zero

To zero the nVision:

- Press the **(zero)** button for at least 1 second while vented to atmosphere until the dashed lines (- - - -) appear.

To clear the zero value:

- Hold the **(zero)** button for 5 seconds until the display changes from (- - - -) to the zeroed value, then to (- -).

CRYSTALCONTROL You can adjust the **Zero Limit** at which the **(zero)** button will display “- -HI- -” in CrystalControl. You can also disable the **(zero)** button entirely, by setting the zero value to a negative number less than -15 psi.

Note: If you attempt to zero the gauge with more pressure applied than the Zero Limit set in with CrystalControl, the command will be ignored, and “- -HI- -” will display.

Note: You can never zero the BARO sensor.

! WARNING: This gauge can display zero pressure when connected to a source of pressure! Do not rely on the display indication before disconnecting—it may not be indicating true pressure. Never disconnect pressure instrumentation without first relieving system pressure!

NUMERICAL DISPLAY OVERVIEW

Numerical Upper and Lower Module screens

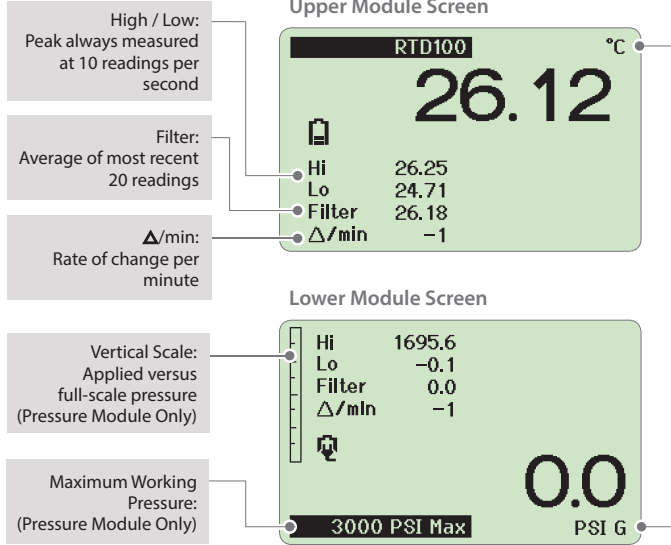

Note:
To change the displayed units on any Numerical Display, see the [Units section](#).

Selectable Units (via Setup button)
CRYSTALCONTROL
(Enable, disable, or create units)

Numerical Dual Mode Screen (Both Sensors)

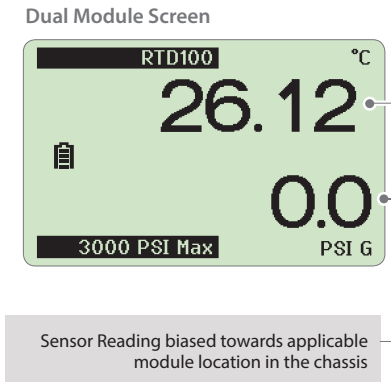

Data Point Counter Screen

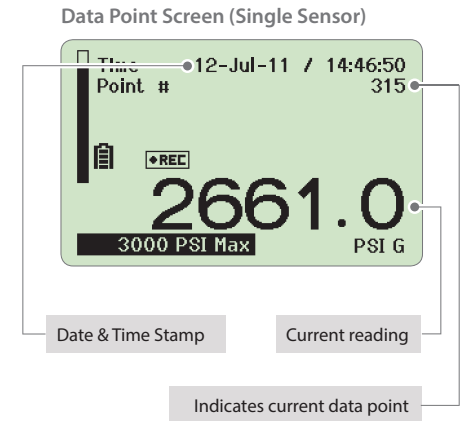

GRAPHICAL DISPLAY OVERVIEW

Graphical Upper and Lower Module screens

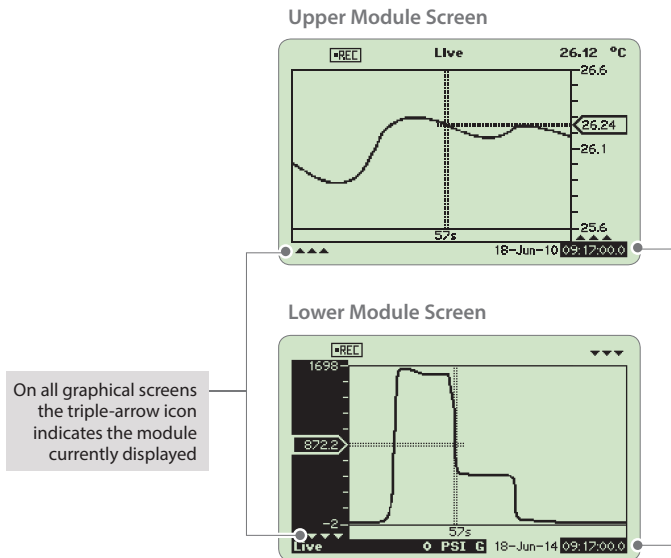

Note:
To change the displayed units on any Graphical Display, see the [Units section](#).

Graphical Dual Mode Screen (Both Sensors)

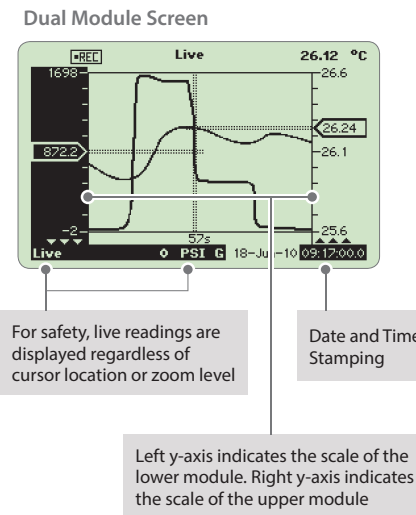

Graphical BARO Screen (Both Sensors)

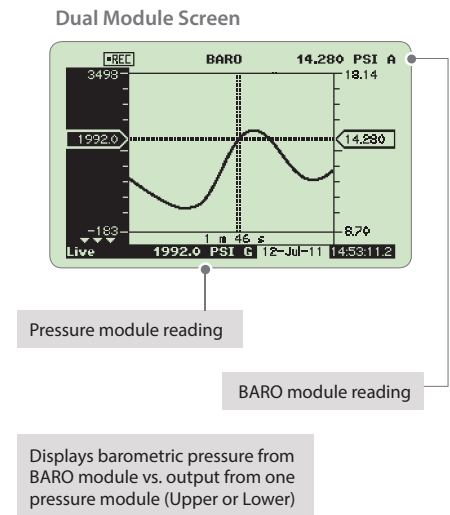

GRAPHING

Navigating the Graphical Display



In the graphical modes the nVision navipad enables you to control how you view your data. The (◀) & (▶) keys allow you to navigate to specific points along your run, while displaying reading and time information. The (▲) & (▼) keys allow you to zoom in and out of your recorded run to suit your needs.

Panning Across the Data Set

To inspect the latest or current data recording, use the (◀) & (▶) keys to move the cursor within the display window. During live recording, data streams from the right side of graphical display screens. Therefore, the most recent data will always appear on the far right of the display.

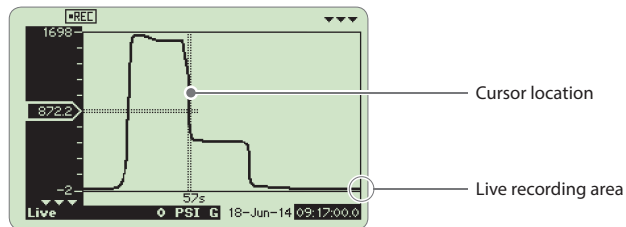

Zooming in on Specific Data

To see more detail on the latest or current data recording, you may zoom in or out on your cursor.

- 1 Use the (▲) and (▼) arrows to zoom in or out in any graphical display, during or after recording.
- 2 To return to the fully zoomed out view (viewing the complete run) simply hold the (▼) arrow for 5 seconds, or until you are completely zoomed out.

Normal View

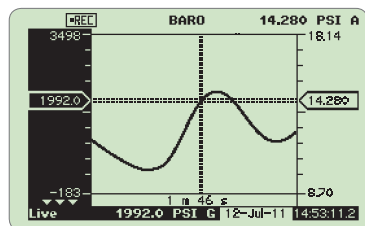

Zoom View

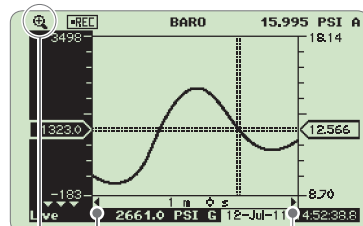

During any zooming keystroke a zoom in (⊕) or zoom out (⊖) icon appears

When zoomed in, small arrows appear on the horizontal time bar.

AVERAGING MODE

Averaging mode reports the average reading during the recorded run. If this screen is enabled, data displayed here represents the average of all past data points, over the duration of a recording. The start date and time, duration of the recorded run, and the live reading are displayed.

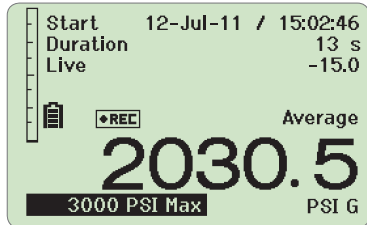

nVision calculates averages as follows:

$$\frac{r_1 + r_2 + r_3 \dots + r_n}{n}$$

r_n = current reading
 n = total number of readings

Averaging Mode

DIFFERENTIAL MODE

The nVision automatically displays numerical and graphical differential screens if two similar module types are installed. ΔP becomes available if your nVision is populated with two PM modules. ΔT becomes available if your nVision is populated with two RTD100 modules.

In the case of the pressure modules (PM), this mode does not require them to be the same full scale range.

! WARNING: Two MA20 modules cannot be installed at once. This configuration may permanently damage your nVision.

In Differential Mode the ΔP or ΔT represents a filtered reading of the upper module – lower module + tare reading.

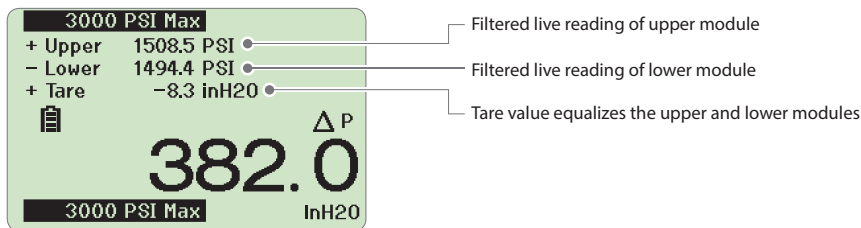

Differential Mode

The units selected for this view are independent of the units selected for the other screens such as the Numerical or Graphical views. Data viewed in the Graphical screens will represent the data acquired from either module and not represent the specialized view of the Differential Mode.

Note: To change the displayed units on any Differential Display, see the [Units section](#).

Tare

Using the Tare function improves your differential measurement uncertainty significantly if used properly. The Tare function equalizes (normalizes) the nVision's two modules at a non-ambient datum. The Tare reading displays the same units as the main ΔP or ΔT reading.

If you apply the same static line pressure, temperature, or resistance signal to both sensors simultaneously, you should have a differential reading of zero. Due to the allowable error tolerance for each module, the reading may not be zero. The Tare function allows you to normalize both readings so that the differential reading is zero. This gives you a more accurate differential reading than if this process were not completed.

Note: Tare should be reestablished every time your measurement conditions change, including vent condition. For instance if your ΔP reading has 8 inH2O of Tare at 1500 psi static, when you return to vent condition this 8 inH2O of Tare will remain in place on your ΔP reading until cleared with the Tare button.

► To Tare:

- 1 Use the **(next)** button to select the Differential Mode Numerical Screen.
- 2 Press the **(zero)** button until the display flashes dashed lines (- - - -).
- 3 To clear the Tare value in the Differential Mode, hold the button for 3 seconds until the main display readings change from (- - - -) to (- - -).

RUN TAGS

CRYSTALCONTROL Run Tags are 22 character identifiers you can enter to name each data run. They are enabled by selecting the Enable Run Tags checkbox. The Run Tags you choose will display in CrystalControl's DataViewer and your downloaded data.

► To use Run Tags:

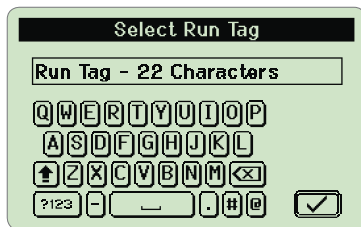

- 1 Press **(record)** from any screen. A QWERTY keyboard will appear, giving you the option to add your Run Tag.
- 2 Use the **(▲)**, **(▼)**, **(▶)**, and **(◀)** arrows and the **(select)** button to edit your Run Tag on the QWERTY keyboard.
- 3 Press the **(next)** button, or move to the onscreen checkbox and press the **(select)** button. Your recording will begin immediately.

You can also enter up to five predefined Run Tags when the Predefined Run Tags box is checked.

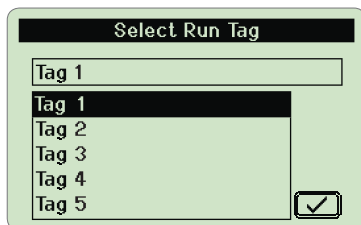

- 1 Press **(record)** from any screen.
- 2 Use the **(▲)**, **(▼)** arrows and the **(select)** button to choose a Run Tag from the list.
- 3 Use the **(▲)**, **(▼)**, **(▶)**, and **(◀)** arrows and the **(select)** button to edit your Run Tag on the QWERTY keyboard.
- 4 Press the **(next)** button, or move to the onscreen checkbox and press the **(select)** button. Your recording will begin immediately.

Note: If you enable Run Tags in CrystalControl, you will be prompted to select a Run Tag prior to every recording. You can also see your Run Tag info through the setup button during a recording. See [View the current Run Tag during a recording](#) for instructions.

Chassis

CHASSIS CONTROLS

Setup Button

Pressing the (setup) button brings up a selectable menu including *Clear Peaks*, *Units*, *Settings*, *Summary*, and *Recording*. On the (navipad), use the (▲) and (▼) arrows to move to the desired feature and use the (select) button or (◀) and (▶) arrows to move into the desired function.

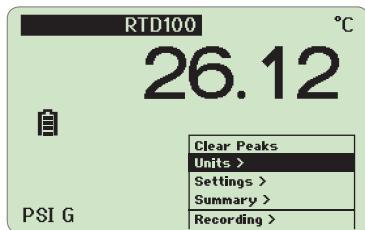

The nVision Setup menu

Clear Peaks (Resetting Hi and Lo Peaks)

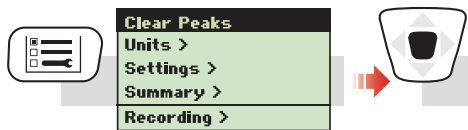

Note: Dashed lines will briefly appear across the peak value indicators. Clearing the peaks will not affect the zero values or the Filter value.

Units

Selecting *Units* allows you to change the displayed units on any screen. See the [module specifications](#) in the Modules section for a list of available units. With a BARO module installed, you can switch between absolute and gauge pressure. On the Differential Mode screen, you can switch the units of the differential measurement. When you change the displayed units for a module, the units for that module will change in every screen—except Differential Mode.

Note:  The unit displayed at the beginning of a recording run remains the default unit for that run. All other units enabled in CrystalControl will be available in CrystalControl's DataViewer.

► Changing Units—Single Module, Numerical or Graphical Screen

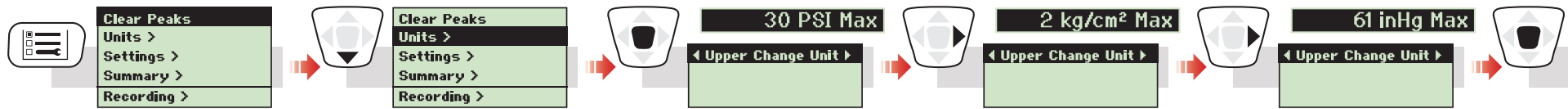

► Changing Units—Dual Module, Numerical or Graphical Screen

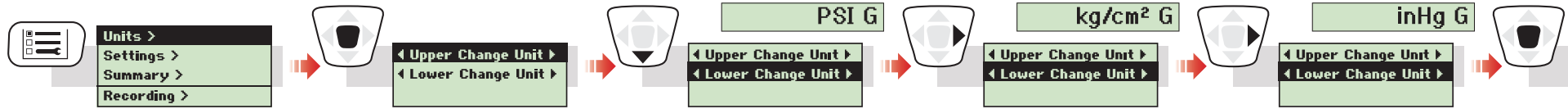

► Changing Units—Differential Screen

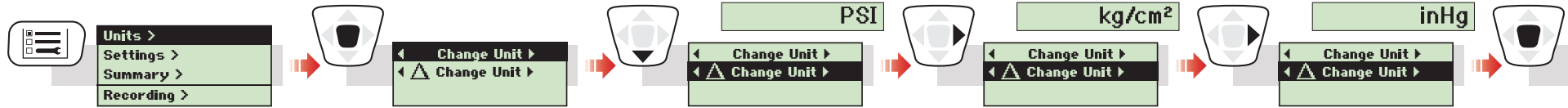

► Changing Units—BARO, Numerical or Graphical Screen

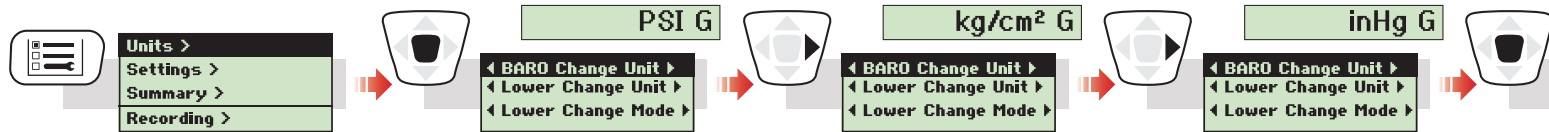

► Changing Between Absolute and Gauge Pressure—Numerical or Graphical Screen

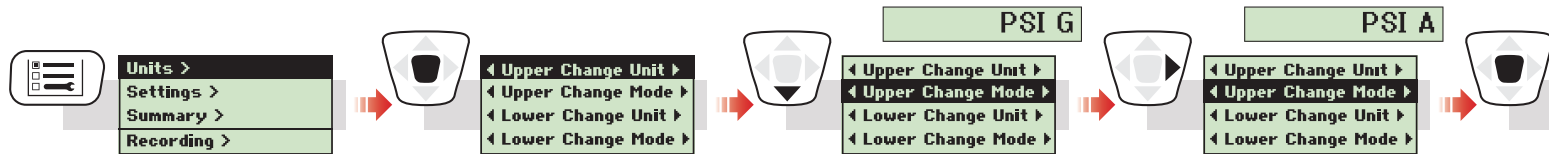

Settings

► Adjust Contrast

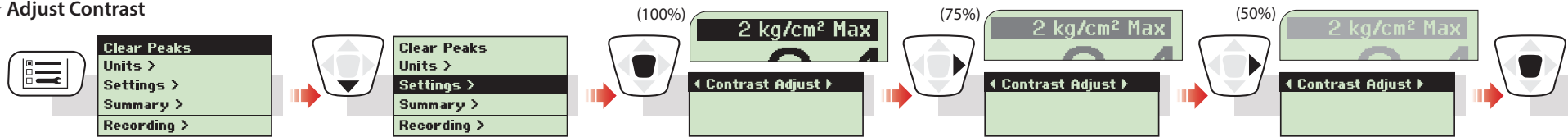

► Lock the nVision

CRYSTALCONTROL The *Screen Lock Password* feature will also be found in *Settings*, if enabled in CrystalControl. Prevent access to your nVision by protecting your device with a 4-digit keypad lockout set in CrystalControl.

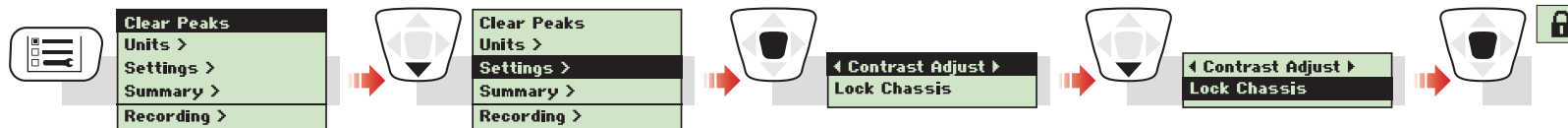

To unlock the nVision, simply enter the 4 digit password with the arrow keys and press the (select) button. The correct password will allow you back into standard nVision operation. An invalid code will reject your attempt and allow you to enter another password.

Note: In the event you lose the password, you will need to contact the factory for an unlock code, which will remove the password protection.

Summary Screen

The Summary screen allows you to view details or settings in your chassis or module.

► View a Module Summary

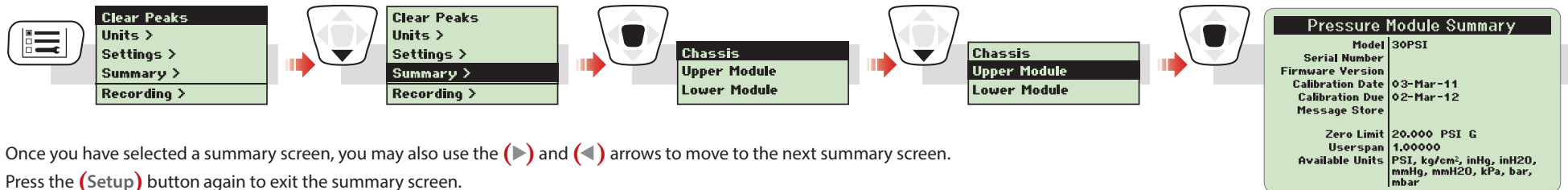

Once you have selected a summary screen, you may also use the (▶) and (◀) arrows to move to the next summary screen. Press the (Setup) button again to exit the summary screen.

Note: If a BARO module is installed, *BARO Module* will appear in the Summary drop-down menu list below *Lower Module*.

► Summary Contents

The specific information in the Summary screens are:

Chassis Summary

- Serial Number
- Date/Time
- Logging Interval
- Firmware Version
- Automatic Shutoff
- Message Store
- CPLD Version
- Backlight Shutoff
- Installed Modules

Module

- Model
- Calibration Date
- Userspan
- Serial Number
- Calibration Due
- Available Units
- Firmware Version
- Message Store

Module Specific Information

- Temp. Coefficients (RTD100)
- Lead Type (RTD100)
- Base Resistance (RTD100)
- Zero Limit (PM)

Recording

► Start a Recording

Press the (record) button until the red LED indicator flashes.

► View the current Run Tag during a recording

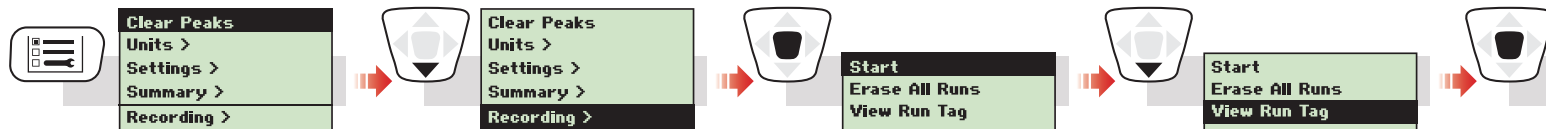

► Erase All Runs



A confirmation screen will ask, *Are You Sure?* Press (select) to continue and erase all the data runs on this nVision. Press the (back) button to cancel.

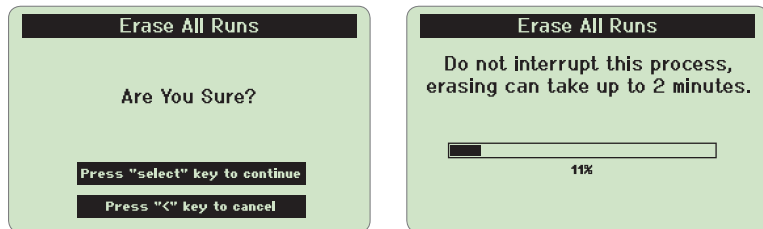

! CAUTION: Never remove power (either battery or USB) during the erasing process.

SERIAL NUMBERS

CRYSTALCONTROL All serial numbers can be viewed using the nVision Summary screens or in CrystalControl.

Each product has a maximum of four serial numbers, one for the chassis and one for each of the modules (upper, lower, and BARO). Chassis serial numbers are located in the power bay or on the rear of the product in the case of the Lab Reference. Module serial numbers are located on the module and can also be viewed in the power bay of the Reference Recorder. Serial Numbers consist of 6 numbers, with the left most digit representing the year of manufacture. For example: 937834 was manufactured during 2009.

nVISION REFERENCE RECORDER SPECIFICATIONS



Temperature (Operating and Storage)

Operating & Compensated -20 to 50°C (-4 to 122°F).

Storage - 40 to 75°C (-40 to 167°F).

Humidity

<95% Relative, non-condensing

IP Rating

IP67 rated enclosure (1m immersion for 30 min) per IEC 60529

Electrical Connection

Electrical Connection mini-USB B (environmentally sealed chassis connector).

nVision under USB power consumes less than 100 mA.

! WARNING: The mini USB B connector shall not be used within the hazardous atmosphere. It shall be used in the non-hazardous atmosphere with either “Safety Extra Low Voltage Circuits” (SELV) or “Protective Extra Low Voltage Circuits” (PELV). The USB connector has a Um of 6V.

SELV and PELV definitions per IEC60079-11 are:

Safety extra-low voltage (SELV): Extra-low voltage system (i.e. normally not exceeding 50 VAC or 120 V ripple-free DC) electrically separated from earth and from other systems in such a way that a single fault cannot give rise to an electrical shock.

Protective extra-low voltage (PELV): Extra-low voltage system which is not electrically separated from earth but which otherwise satisfies the requirements for SELV.

Note: A 50V center-tapped earth system is a PELV system.

Mounting

Permanent Mounting four M4 x 0.7 threaded inserts: 8mm deep (see drawing for location)

Enclosure

Impact resistant injection molded housing and elastomeric protective boot compatible with common industrial fluids, including Skydrol.

Weight: 680g (1.5 lbs) including one each PM and RTD100 module, 4AA battery module, and protective boot.

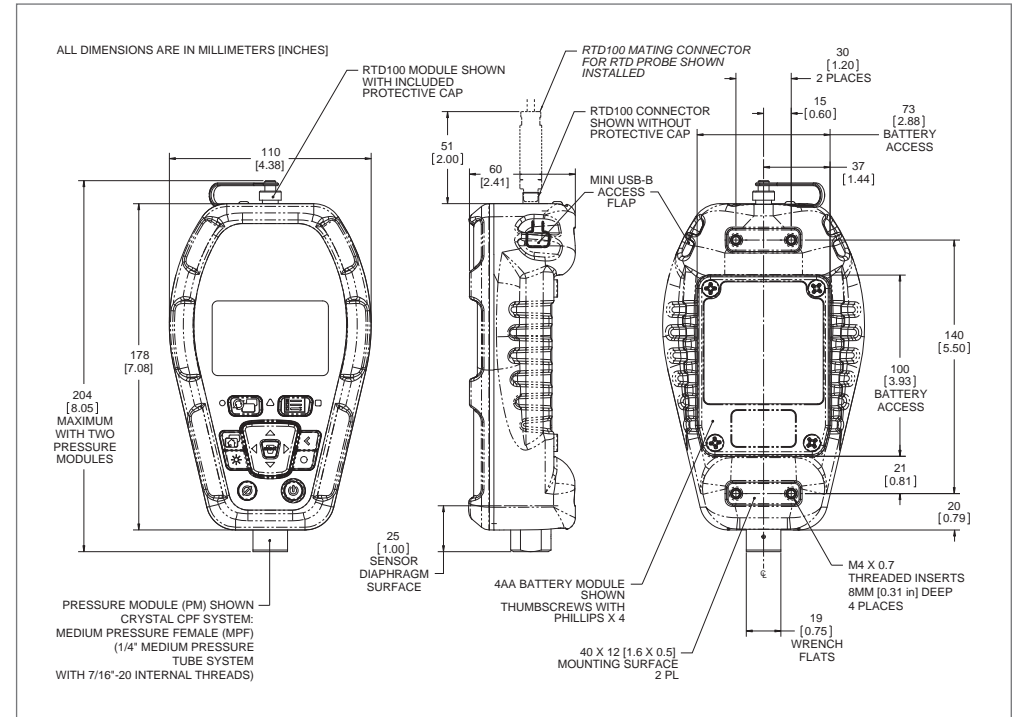

The nVision enclosure

NVISION LAB REFERENCE SPECIFICATIONS



Temperature (Operating and Storage)

Operating & Compensated 10 to 50°C (50 to 122°F).

Storage 0 to 75°C (32 to 167°F).

Humidity

<95% Relative, non-condensing

IP Rating

IP40 rated enclosure per IEC 60529

Electrical Connection

Electrical Connection (Communication) . . . mini-USB B.

Electrical Connection (Power) . . . 100-240VAC, 50-60 Hz with international plug adapters.

! WARNING: nVision Lab Reference and the mini USB B shall not be used within hazardous atmospheres.

Mounting

Rack Mount Kit two rack mount ears with hardware.

Enclosure

Enclosure Powder coated metal enclosure.

Weight 2.2 kg (4.75 lbs) including two pressure modules.

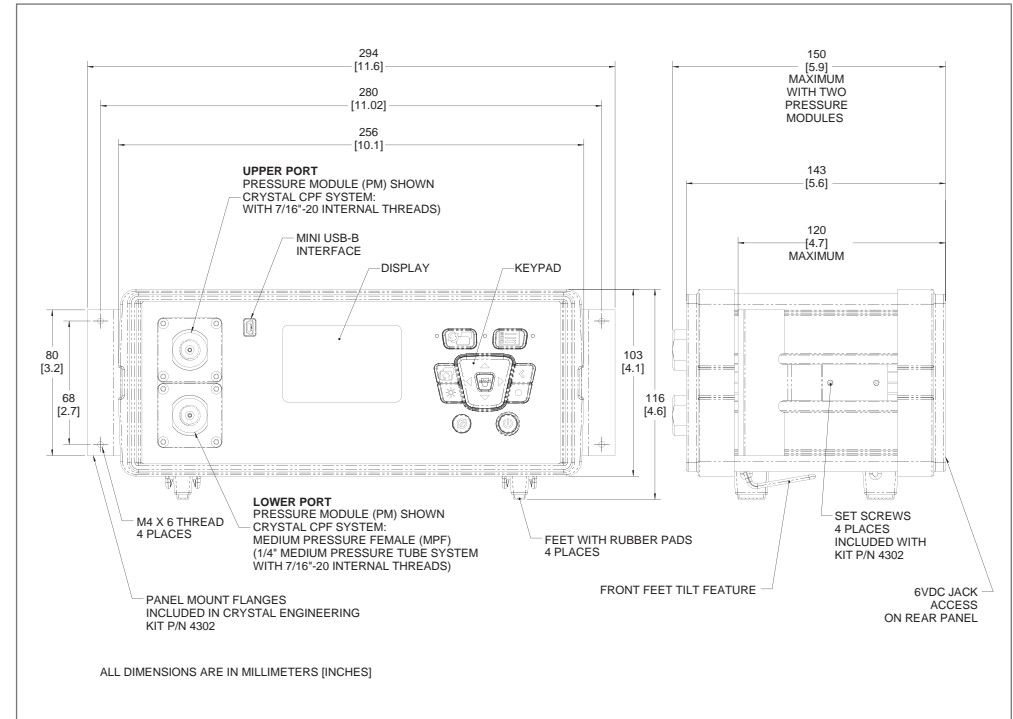

The nVision Lab enclosure

Modules

MODULE INSTALLATION INSTRUCTIONS

The nVision's upper and lower bays allow for removal of modules in the field. All module changes should be completed in a dry, clean environment, indoors. Proper electrostatic discharge (ESD) grounding techniques should be taken into account prior to the module change over. If you're removing a module without installing a replacement, a blank plate (P/N: BNKPLT) must be installed to ensure your IP67 rating and to protect the product.

! WARNING: Do not install two MA20 modules simultaneously. Permanent damage may occur.

! CAUTION: Do not proceed unless you have a suitable replacement module or blank plate for the module bay in question.

Note: Follow these steps to change modules.

- 1 **CRYSTALCONTROL** Before removing or replacing any modules, ensure that all recorded data has been archived properly through the use of Export Data in CrystalControl.
- 2 Clean exterior of nVision, if necessary, to ensure no moisture or foreign matter will enter the enclosure when disassembled.
- 3 Power off nVision and remove any existing power or USB connections.



! WARNING: Failure to disconnect nVision from 4AA, USB, or AC power before module removal or installation may cause damage.

- 4 Loosen the four T10 Torx screws retaining the module face plate and carefully pull the module straight out of the chassis (avoid twisting). Make note of the orientation of module connector (located closest toward the display) in relation to the nVision chassis.

Note: Please ensure that the module's o-ring is also removed with the module.

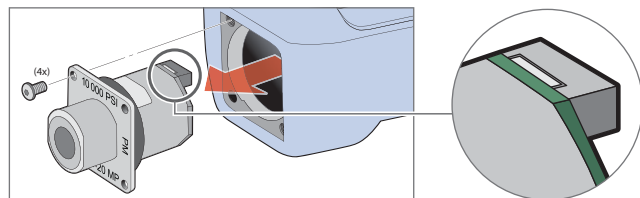

Note: Due to the physical form and the IP67 sealing strategy employed, some modules may be difficult to remove. If necessary, connect a fitting or RTD cable to the appropriate module to aid in module removal. Never force the separation of a module from an nVision chassis.

- 5 Install a new module in the same orientation as the one removed in step 4. The tri-lobe design of the module will not allow improper installation; do not force installation of the module as permanent damage may occur. To ensure an IP67 rated seal, lightly lubricate the module's o-ring (P/N: 4110) with Dow 111 silicon lubricant or equivalent.

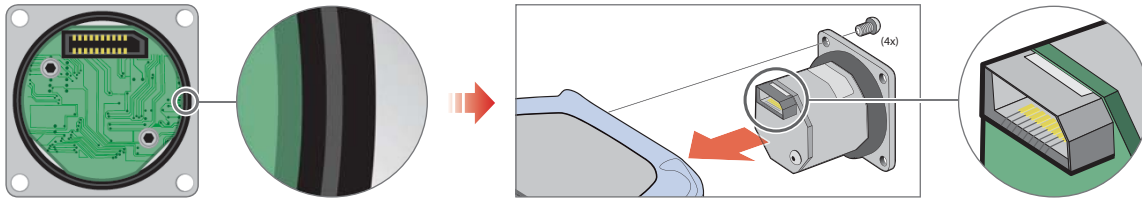

Lightly lubricate the o-ring, then install the module in the proper orientation.

Note: If installing a Blank Plate, confirm orientation is flat and even within the module bay for proper sealing.

- 6 Tighten face plate T10 Torx screws to 50 in-oz (0.35 newton meter (N-m)) torque.
- 7 Replace power module/plug and tighten to 50 in-oz (0.35 newton meter (N-m)) torque to ensure IP67 seal. When power is first applied the unit will automatically turn on. Ensure that nVision recognizes the new module by confirming in CrystalControl or the Summary screens.

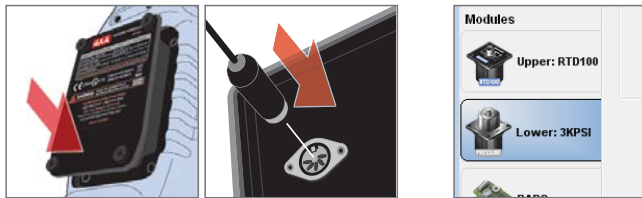

- 8 Before using the nVision to record, Erase All Data. See [Recording](#) in the Chassis chapter.
- 9 If you have any problems during this process, check the [Troubleshooting section](#) for relevant information or contact us at crystal@ametek.com or (805) 595-5477.

PRESSURE MODULE (PM) INSTRUCTIONS

Pressure Connection

Crystal CPF System: Medium Pressure Female (MPF) (1/4" medium pressure tube system with 7/16-20 threads). See our [CPF Brochure](#) for further information.

CPF o-ring size and material: AS568A-012, Viton 90 durometer (P/N 3981).

For most applications CPF Fittings can be hand tightened (no tools required). Wrench tightening is recommended (to achieve a metal to metal cone seal) for applications where chemical compatibility of the process fluid and the o-ring are a concern. Cone seals require only moderate assembly torque to seal up to 10 000 psi (700 bar). We recommend a tightening torque of 120 in-lbs \pm 20 in-lbs for our CPF fittings. Please note this is only a fraction of the typical torque required to seal a 1/4" NPT fitting. If a torque wrench isn't practical to use, the fittings can be assembled as follows: Hand tighten fitting fully until the cone has bottomed out. Tighten an additional 20° using a wrench. Apply a small amount of media-compatible lubricant to the gland threads and male cone to increase fitting life, reduce the likelihood of galling, and promote sealing.

CAUTION: To achieve CPF maximum allowable working pressures no o-ring substitutions are allowed. See our CPF brochure and CES-003 CPF Safety Guide available from the website at ametkcalibration.com for further detail.

Measuring Vacuum

All versions of the nVision can be used to measure moderate vacuum.

When measuring pressure less than ambient barometric conditions, a minus (-) sign will appear.

CAUTION: The nVision is not recommended for continuous use at high vacuum.

Water Density (Inches of Water)

The following applies only to models where inches of water is a selectable pressure unit. As shipped from the factory, the nVision is set to display inches of water corresponding to the density of water at 4°C (39.2°F).

 You may require a different water density for your application. CrystalControl allows the user to select the appropriate water density desired at 4°C (39.2°F), 20°C (68°F), or 15.6°C (60°F) temperatures.

Overpressure Conditions

The nVision will read pressure up to approximately 110% of the rated pressure range. Above 110% of the range the display will start flashing and the readings will not be reliable. The zero function does not affect when the display starts flashing to indicate overpressure, so depending on the zero value it is possible that the display can start flashing without the maximum pressure being displayed.

For instance, if a 100 psi nVision is zeroed when 30 psi is being applied, it will indicate that the overpressure condition has been reached at 80 psi (i.e., 110% x 100 psi – 30 psi = 80 psi).

Overpressure can affect accuracy, but the effect is only temporary unless the sensor has been destroyed. See [Pressure Module \(PM\) Specifications](#) for maximum allowable overpressure ratings.

PRESSURE MODULE (PM) SPECIFICATIONS

Pressure Module Tables

	Module Range	0 - 30% Gauge Full Scale	30 - 110% Gauge Full Scale
	psig	± (% Full Scale)	± (% of Reading)
psi	30	0.0075%	0.025%
	100	0.0075%	0.025%
	300	0.0075%	0.025%
	1000	0.015%	0.05%
	3000	0.015%	0.05%
	10000	0.015%	0.05%
	15000	0.015%	0.05%

	barG	± (% Full Scale)	± (% of Reading)
	bar	3	0.0075%
10		0.0075%	0.025%
30		0.0075%	0.025%
100		0.015%	0.05%
300		0.015%	0.05%
700		0.015%	0.05%
	1000	0.015%	0.05%

	kPaG / MPaG	± (% Full Scale)	± (% of Reading)
	kPa / MPa	300	0.0075%
1		0.0075%	0.025%
3		0.0075%	0.025%
10		0.015%	0.05%
30		0.015%	0.05%
70		0.015%	0.05%
	100	0.015%	0.05%

	kg/cm ² G	± (% Full Scale)	± (% of Reading)
	kg/cm ²	3	0.0075%
10		0.0075%	0.025%
30		0.0075%	0.025%
100		0.015%	0.05%
300		0.015%	0.05%
700		0.015%	0.05%
	1000	0.015%	0.05%

Accuracy (Gauge)

0 to 30% of Full Scale ±(0.0075% of Full Scale) or ±(0.015% of Full Scale)

30 to 110% of Full Scale..... ±(0.025% of Reading) or ±(0.05% of Reading)

Vacuum for 300PSI, 30BAR, 3MPa, 30KG and lower pressure modules:
±(0.06% of Full Scale*)

*Full Scale = -14.5 psig, -1.0 bar, -99.9 kPa, -1.0 kg/cm².

Accuracy specifications include all effects of linearity, hysteresis, repeatability, temperature, and stability for one year.

Note: Exposure to environmental extremes of temperature, shock, and/or vibration may warrant a more frequent recertification period.

PM modules must be exercised and re-zeroed whenever exposed to significant changes in environmental conditions to achieve these specifications. To exercise a gauge, cycle the gauge between zero (ambient barometric pressure) and the pressure of interest. A properly exercised gauge will return to a zero reading (or return to the same ambient barometric reading).

! CAUTION: Pressure Modules (PM) are not recommended for continuous use at high vacuum.

Accuracies, Ranges, and Resolutions

	psi	bar	kPa/MPa	kg/cm2	Overpressure	psi	kg/cm2	inHg	inH2O*	mmHg	mmH2O	kPa	bar	mbar	MPa
0.025% of Reading modules	30PSI				3.0 x	0.001	0.0001	0.001	0.01	0.01	1	0.01	0.0001	0.1	
		3BAR			3.0 x	0.001	0.0001	0.001	0.01	0.01	1	0.01	0.0001	0.1	
			300KPA		3.0 x							0.01	0.0001	0.1	
				3KG	3.0 x	0.001	0.0001	0.001	0.01	0.01	1	0.01	0.0001	0.1	
	100PSI				2.0 x	0.001	0.0001	0.01	0.1	0.1	1	0.01	0.0001	0.1	0.00001
		10BAR			2.0 x	0.001	0.0001	0.01	0.1	0.1	1	0.01	0.0001	0.1	0.00001
			1MPA		2.0 x							0.01	0.0001	0.1	0.00001
				10KG	2.0 x	0.001	0.0001	0.01	0.1	0.1	1	0.01	0.0001	0.1	0.00001
	300PSI				2.0 x	0.01	0.001	0.01	0.1	0.1		0.1	0.001	1	0.0001
		30BAR			2.0 x	0.01	0.001	0.01	0.1	0.1		0.1	0.001	1	0.0001
			3MPA		2.0 x							0.1	0.001	1	0.0001
				30KG	2.0 x	0.01	0.001	0.01	0.1	0.1		0.1	0.001	1	0.0001
0.05% of Reading modules	1KPSI				2.0 x	0.1	0.001	0.1				0.1	0.001		0.0001
		100BAR			2.0 x	0.1	0.001	0.1				0.1	0.001		0.0001
			10MPA		2.0 x							0.1	0.001		0.0001
				100KG	2.0 x	0.1	0.001	0.1				0.1	0.001		0.0001
	3KPSI				1.5 x	0.1	0.01	0.1				1	0.01		0.001
		300BAR			1.5 x	0.1	0.01	0.1				1	0.01		0.001
			30MPA		1.5 x							1	0.01		0.001
				300KG	1.5 x	0.1	0.01	0.1				1	0.01		0.001
	10KPSI				1.5 x	1	0.01					1	0.01		0.001
		700BAR			1.5 x	1	0.01					1	0.01		0.001
			70MPA		1.5 x							1	0.01		0.001
				700KG	1.5 x	1	0.01					1	0.01		0.001
	15KPSI				1.3 x	1	0.01					1	0.01		0.001
		1000BAR			1.3 x	1	0.01					1	0.01		0.001
			100MPA		1.3 x							1	0.01		0.001
				1000KG	1.3 x	1	0.01					1	0.01		0.001

* Density of water can be set to 4°C, 60°F or 20°C /68°F with CrystalControl software .

► Reference Recorder Numbering System

Product ID	Power	Upper Chassis Module	Lower Chassis Module	BARO Module (Optional)
NV	4AA	—	—	—
Sample Part Numbers		PM	PM	No: (omit)
NV-4AA-30PSI-3KPSI-BARO		MA20	MA20	Yes: BARO
NV-4AA-RTD100-10KPSI		RTD100	RTD100	

► Lab Reference Numbering System

Product ID	Power	Upper Chassis Module	Lower Chassis Module	BARO Module (Optional)
NL	LAB	—	—	—
Sample Part Numbers		PM	PM	No: (omit)
NL-LAB-30PSI-1KPSI		MA20	MA20	Yes: BARO
NL-LAB-MA20-3KPSI-BARO		RTD100	RTD100	

To order the Reference recorder or Lab Reference with a single module, enter **BNKPLT** (blank plate) for either the upper or lower chassis module.

Differential Pressure Measurement Uncertainties without Tare

The total nVision Reference Calibrator measurement uncertainty in the ΔP mode configuration will need to consider the uncertainties of both pressure modules. We recommend the module uncertainties to be combined with the preferred square root of the sum of the squares (or “root sum squares”) method.

The following table lists the possible combinations of combining Pressure Modules (PM) with different accuracy statements. The uncertainties reported below are without using the Tare feature which will greatly improve your measurement uncertainty.

		Upper Pressure Module Uncertainties (of Static Line Pressure) (of Reading)	
		0.025%	0.05%
Lower Pressure Module Uncertainties (of Static Line Pressure) (of Reading)	0.025%	0.035%	0.056%
	0.05%	0.056%	0.071%

Differential Pressure Measurement Uncertainties with Tare

The Tare function can improve measurement uncertainties on two modules with the same full scale pressure range installed into one nVision Reference Recorder.

The following specifications apply to the measurement system with a logging interval of 1 reading/second or slower:

Full Scale Range of Both Sensors				The Greater of (+/-)				
psi	bar	kPa/MPa	kg/cm ²	psi	mbar	inH ₂ O	mmH ₂ O	% of DP Reading
30	3	300	3	0.0005	0.04	0.014	0.4	0.025%
100	10	1	10	0.0015	0.10	0.04	1.0	0.025%
300	30	3	30	0.005	0.4	0.14	4.0	0.025%
1000	100	10	100	0.02	1.0	0.4	10.0	0.05%
3000	300	30	300	0.05	4.0	1.4	n/a	0.05%
10000	700	70	700	0.2	10.0	4.0	n/a	0.05%
15000	1000	100	1000	0.3	15.0	6.0	n/a	0.05%

 Unit must be enabled in CrystalControl

Differential Pressure Resolution

psi	bar	kPa/MPa	kg/cm ²	psi	kg/cm ²	inHg	inH ₂ O	mmHg	mmH ₂ O	kPa	bar	mbar	MPa
30	3	300	3	0.0001	0.00001	0.0001	0.001	0.001	0.1	0.001	0.00001	0.01	0.00001
100	10	1	10	0.0001	0.00001	0.001	0.01	0.01	0.1	0.001	0.00001	0.01	0.00001
300	30	3	30	0.001	0.0001	0.001	0.01	0.01	0.1	0.01	0.0001	0.1	0.00001
1000	100	10	100	0.01	0.0001	0.01	0.1	0.1	0.1	0.01	0.0001	0.1	0.00001
3000	300	30	300	0.01	0.001	0.01	0.1	0.1	n/a	0.1	0.001	0.1	0.0001
10000	700	70	700	0.1	0.001	0.1	0.1	0.1	n/a	0.1	0.001	0.1	0.0001
15000	1000	100	1000	0.1	0.001	0.1	0.1	0.1	n/a	0.1	0.001	0.1	0.0001

 Unit must be enabled in CrystalControl

User Defined Units

 The nVision gives you the ability to create your own custom User Defined Unit based on pressure. Implement your slope (user factor) and offset (offset factor) in CrystalControl. See CrystalControl application and manual for details.

Pressure Conversions

1 psi =	27.6806 inH ₂ O (water at 4°C [39.2°F])
	27.7070 inH ₂ O (water at 15.6°C [60°F])
	27.7292 inH ₂ O (water at 20°C [68°F])
	2.03602 inHg (mercury at 0°C [32°F])
	51.7149 mmHg (mercury at 0°C [32°F])
	703.087 mmH ₂ O (water at 4°C [39.2°F])
	0.070307 kg/cm ²
	68.948 mbar
	6.8948 kPa
	0.068948 bar
0.006895 MPa	

Logging Interval

Fastest Logging Interval. 10 readings per second

Media Compatibility

Liquids and gases compatible with sensor and CPF fitting system:

Wrench-tight 316 Stainless Steel

Finger-tight. 316 Stainless Steel and Viton (internal MPF o-ring)

BAROMETRIC REFERENCE (BARO) MODULE INSTRUCTIONS

CRYSTALCONTROL Installation of the BARO module in the power bay allows you to convert your gauge pressure measurement to the absolute scale if so desired. You may also view the barometric reference reading directly on a dedicated numerical screen. When the BARO module is installed, it may also be disabled in CrystalControl to conserve battery power, however your nVision will not be able to display absolute readings unless it is active.

Installation

The BARO module is located in the power bay of the nVision. nVision Lab Reference units must have BARO installation done at the factory. As with the traditional modules, installation of the BARO module should be done in a ESD compliant, dry, clean environment, using the instructions below.

CAUTION: The BARO module requires CPLD version 6 or greater to operate properly. If you have CPLD 5 or earlier the nVision must return to the factory for updating. You may determine your CPLD version in the Chassis Summary screen or in CrystalControl.

- 1 Place the nVision face down on clean stable work surface.
- 2 Remove USB power connection and power pack from the nVision.
- 3 Remove your BARO module from factory packaging, grasp the cover, and orient as shown.
- 4 Slide the BARO module into the connector system.
- 5 Insert screw through cover and into the nVision, and tighten to 16 in-oz (0.11 newton meter (N-m)) torque to secure BARO module properly.

Note: Remember to enable the module in CrystalControl if module is a new installation.

Note: Reset the nVision chassis after enabling or disabling the BARO.

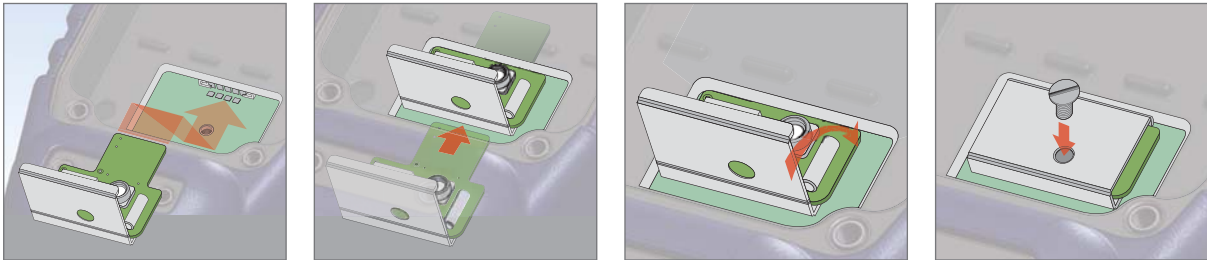

BARO module installation.

BAROMETRIC REFERENCE (BARO) MODULE SPECIFICATIONS

Absolute pressure mode is achieved by using the BARO Reference Module to establish a datum. The PM and BARO sensor uncertainties were combined to establish a new accuracy statement for readings taken in the absolute mode. It must be noted that the accuracy statement is valid for readings of 1 barA or greater.

Accuracy

± 0.00725 psi, ± 0.5 mbar

Accuracy specifications include all effects of linearity, hysteresis, repeatability, temperature, and stability within the specified operating temperature range for one year.

Note: Exposure to environmental extremes of temperature, shock, and/or vibration may warrant a more frequent recertification period.

Ranges, Resolutions, and Units

Range 10.153 to 15.954 psiA, 700 to 1100 mbarA

► Units and Resolution

psi 0.001

inHg 0.001

mmHg 0.01

mbar 0.1

Logging Interval

Fastest Logging Interval. 10 readings per second

Pressure Connection

Cylindrical sensor fitting of 5.8mm OD. A flexible 4.8 mm [3/16"] ID tube is recommended to connection for both nVision chassis forms.

Mounting

BARO Module is secured using 3/8" 4-40 plastic screw.

! WARNING: Plastic non-conductive screw must be used to comply with hazardous locations requirements.

! CAUTION: Direct contact with barometric sensor may cause permanent damage. Direct sunlight on exposed BARO sensor may affect readings slightly.

ABSOLUTE PRESSURE SPECIFICATIONS

psiA (Pressure with BARO module)

30 psi module

0.200 to 14.500 psiA: **±0.011 psiA**
 14.500 to 44.500 psiA: **±(0.025% of Reading)**
+ 0.003 psiA

100 psi module

0.200 to 14.500 psiA: **±0.011 psiA**
 14.500 to 44.500 psiA: **± 0.011 psiA**
 44.500 to 114.500 psiA: **±(0.025% of Reading)**

300 psi module

0.20 to 14.50 psiA: **±0.01 psiA**
 14.50 to 104.50 psiA: **± 0.03 psiA**
 104.50 to 314.50 psiA: **±(0.025% of Reading)**

1000 psi module

14.5 to 314.5 psiA: **± 0.2 psiA**
 314.5 to 1014.5 psiA: **±(0.05% of Reading)**

3000 psi module

14.5 to 914.5 psiA: **± 0.5 psiA**
 914.5 to 3014.5 psiA: **±(0.05% of Reading)**

10 000 psi module

15 to 3015 psiA: **± 2 psiA**
 3015 to 10 015 psiA: **±(0.05% of Reading)**

15 000 psi module

15 to 4515 psiA: **± 3 psiA**
 4515 to 15 015 psiA: **±(0.05% of Reading)**

barA (Pressure with BARO module)

3 bar module

0.0138 to 1.0000 barA: **±0.0008 barA**
 1.0000 to 4.0000 barA: **±(0.025% of Reading)**
+0.0003 barA

10 bar module

0.0138 to 1.0000 barA: **±0.0008 barA**
 1.0000 to 4.0000 barA: **± 0.0010 barA**
 4.0000 to 11.0000 barA: **±(0.025% of Reading)**

30 bar module

0.014 to 1.000 barA: **±0.001 barA**
 1.000 to 10.000 barA: **± 0.003 barA**
 10.000 to 31.000 barA: **±(0.025% of Reading)**

100 bar module

1.000 to 31.000 barA: **± 0.015 barA**
 31.000 to 101.000 barA: **±(0.05% of Reading)**

300 bar module

1.00 to 91.00 barA: **± 0.05 barA**
 91.00 to 301.00 barA: **±(0.05% of Reading)**

700 bar module

1.00 to 211.00 barA: **± 0.11 barA**
 211.00 to 701.00 barA: **±(0.05% of Reading)**

1000 bar module

1.00 to 301.00 barA: **± 0.15 barA**
 301.00 to 1001.00 barA: **±(0.05% of Reading)**

MPaA (Pressure with BARO module)

300 kPa module

1.38 to 100.00 kPaA: **±0.08 kPaA**
 100.00 to 400.00 kPaA: **±(0.025% of Reading)**
+0.03 kPaA

1 MPa module

0.00138 to 0.10000 MPaA: **±0.00008 MPaA**
 0.10000 to 0.40000 MPaA: **± 0.00010 MPaA**
 0.40000 to 1.10000 MPaA: **±(0.025% of Reading)**

3 MPa module

0.0014 to 0.1000 MPaA: **±0.0001 MPaA**
 0.1000 to 1.000 MPaA: **± 0.0003 MPaA**
 1.000 to 3.1000 MPaA: **±(0.025% of Reading)**

10 MPa module

0.1000 to 3.1000 MPaA: **± 0.0015 MPaA**
 3.1000 to 10.1000 MPaA: **±(0.05% of Reading)**

30 MPa module

0.100 to 9.100 MPaA: **± 0.005 MPaA**
 9.100 to 30.100 MPaA: **±(0.05% of Reading)**

70 MPa module

0.100 to 21.100 MPaA: **± 0.011 MPaA**
 21.100 to 70.100 MPaA: **±(0.05% of Reading)**

100 MPa module

0.100 to 30.100 MPaA: **± 0.015 MPaA**
 30.100 to 100.100 MPaA: **±(0.05% of Reading)**

kg/cm²A (Pressure with BARO module)

3 kg/cm² module

0.0141 to 1.0000 kg/cm²A: **±0.0008 kg/cm²A**
 1.0000 to 4.0000 kg/cm²A: **±(0.025% of Reading)**
+0.0003 kg/cm²A

10 kg/cm² module

0.0141 to 1.0000 kg/cm²A: **±0.0008 kg/cm²A**
 1.0000 to 4.0000 kg/cm²A: **± 0.0010 kg/cm²A**
 4.0000 to 11.0000 kg/cm²A: **±(0.025% of Reading)**

30 kg/cm² module

0.014 to 1.000 kg/cm²A: **±0.001 kg/cm²A**
 1.000 to 10.000 kg/cm²A: **± 0.003 kg/cm²A**
 10.000 to 31.000 kg/cm²A: **±(0.025% of Reading)**

100 kg/cm² module

1.000 to 31.000 kg/cm²A: **± 0.015 kg/cm²A**
 31.000 to 101.000 kg/cm²A: **±(0.05% of Reading)**

300 kg/cm² module

1.00 to 91.00 kg/cm²A: **± 0.05 kg/cm²A**
 91.00 to 301.00 kg/cm²A: **±(0.05% of Reading)**

700 kg/cm² module

1.00 to 211.00 kg/cm²A: **± 0.11 kg/cm²A**
 211.00 to 701.00 kg/cm²A: **±(0.05% of Reading)**

1000 kg/cm² module

1.00 to 301.00 kg/cm²A: **± 0.15 kg/cm²A**
 301.00 to 1001.00 kg/cm²A: **±(0.05% of Reading)**

CURRENT, VOLTAGE, AND SWITCH TEST (MA20) MODULE INSTRUCTIONS

The nVision MA20 module has three operational modes: current measurement, voltage measurement, and switch test. Each mode may be selected via the Setup menu, and can only be operated one at a time.

To ensure proper connection to the MA20 Module use the following strategy:

- 1 Ensure that power is off on the circuit that you are about to measure.
- 2 Ensure your Vision is in correct MA20 Mode: mA, %4-20mA, %10-50mA (MA20+), Voltage, or Switch Test.
- 3 Insert the Negative (black) 2mm lead jack to the proper location (black terminal) on the MA20 module. Connect the other end of the black lead to the appropriate terminal of the source.
- 4 Insert the Positive (red) 2mm lead jack to the proper location (red terminal) on the MA20 module. Connect the other end of the red lead to the appropriate terminal of the source.
- 5 Power up circuit and measure or record the readings as appropriate.
- 6 Never change modes or electrical sources without first removing the nVision from the circuit. Failure to do so may damage the nVision.

! WARNINGS: The following warnings apply to the MA20 module:

- Never install two (2) MA20 modules simultaneously. This configuration may permanently damage your nVision.
- Never exceed the maximum specified voltage or current ratings on the MA20 inputs. Doing so may permanently damage the MA20 module.
- Check the test leads for continuity before using. Replace damaged test leads. Do not use the probes if they are cracked, have damaged insulation, exposed metal, or high resistance.
- Always remove the test leads from the module before opening the battery compartment.
- When using test lead probes, always make sure your fingers are behind the finger guards on the probes.
- Never connect more than two (2) test leads to a MA20 module at a time.

Current Mode

The nVision is capable of measuring current in three different modes. They are:

- mA: Measured current is displayed (mA). The module is capable of measuring inputs up to 55mA
- 4–20%: Current is displayed as a percentage of the 4–20mA current range of the module. Where: 4mA = 0%, and 20mA = 100%
- 10–50%: Current is displayed as a percentage of the 10–50mA current range of the MA20+ module. Where: 10mA = 0%, and 50mA = 100%

► Current Measurement

The nVision may be used to measure current up to 50mA. Select the desired current mode through the Setup menu to properly configure the nVision prior to connection and use.

► Current Measurement with HART Resistor

The nVision may be used to measure current in a circuit that includes a HART transmitter or device. For devices that use the HART protocol, a load resistor must be placed in the loop. The HART input on the MA20 provides a 250 Ohm load resistor. Select the desired current mode through the Setup menu to properly configure the nVision prior to connection and use.

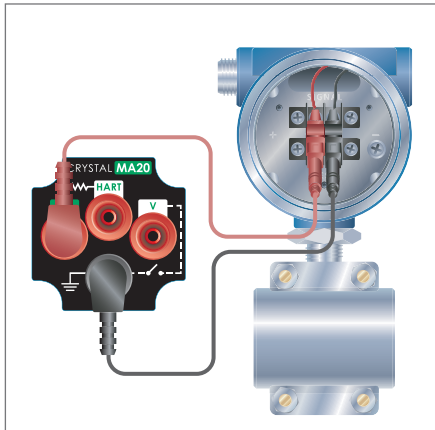

MA20 module Current Measurement connection.

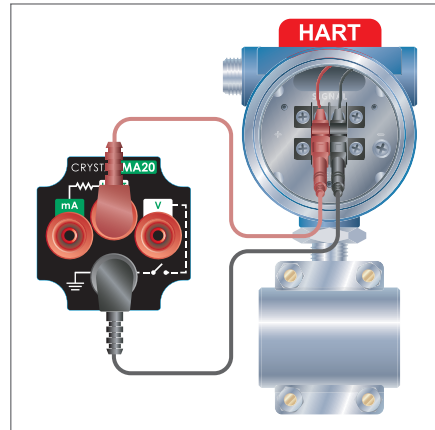

MA20 module with HART load resistor.

Voltage Mode

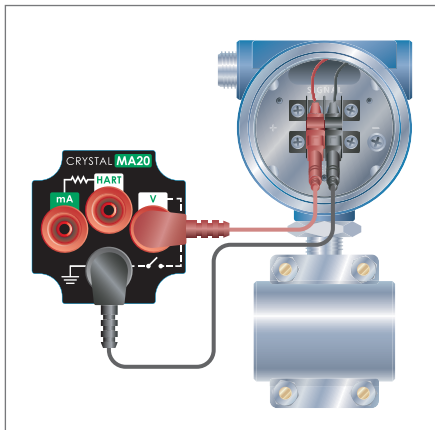

MA20 module Voltage connection.

The nVision may be used to measure voltages up to 28VDC. Select the Voltage mode through the Setup menu to properly configure the nVision prior to connection and use.

Switch Test Mode

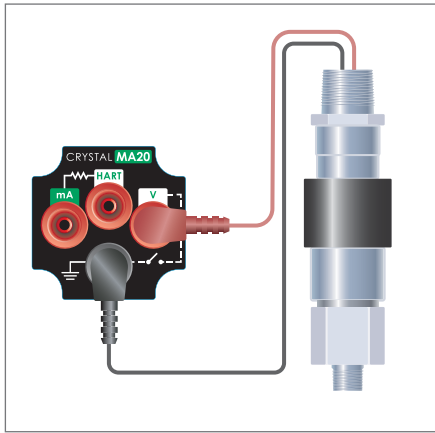

The nVision may be used to detect switch closures. Select the Switch Test mode through the Setup menu to properly configure the nVision prior to connection and use. The illustration denotes the proper Switch Test connection scheme to the MA20 module.

MA20 module Switch Test connection.

CURRENT, VOLTAGE, AND SWITCH TEST (MA20) MODULE SPECIFICATIONS

Modes		
Current	mA	%4–20, %10–50
Current with HART Resistor	mA	%4–20, %10–50
Voltage	V	
Switch Detection	Open	Closed

Connection

2mm banana jacks for sheathed plugs. 12.7mm (0.5 in) spacing.

Terminals

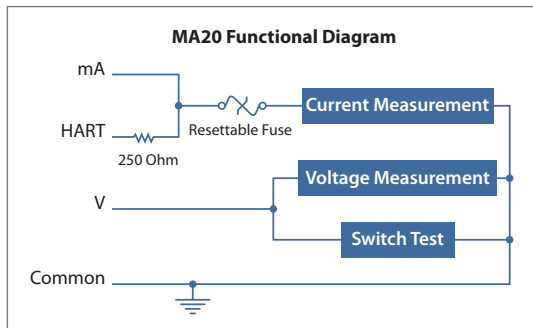

Logging Interval

Fastest Logging Interval. 6 readings per second.

Note: Although nVision logging interval may be set to a faster rate, the MA20 module will update the reading at 6 times per second.

ATEX and IECEx Scheme Entity Parameters

The MA20 Module has these specific input entity parameters:

U _i = 28 V	U _o = 6.6 V
I _i = 93.3 mA	I _o = 4.45 mA
P _i = 653.3 mW	P _o = 7.34 mW
C _i = 0.36 uF	C _o = 0.5 uF**
L _i = 39.1 uH	L _o = 12 uH*

* Total cable inductance between all modules

** Dependent on the supply to the terminals but shall not be greater than 0.5 uF

Current (mA) Input

► Accuracy

±(0.015% of reading + 0.002mA)

Accuracy specifications include all effects of linearity, hysteresis, repeatability, temperature, and stability within the specified operating temperature range for one year.

Note: Exposure to environmental extremes of temperature, shock, and/or vibration may warrant a more frequent recertification period.

► Ranges, Resolutions, and Units

Range 0 to 55mA (MA20+)

Range 0 to 25mA (MA20)

Max Allowable Current 93.3mA

Note: Inputs protected by resettable fuse

Resolution 0.001mA or 0.01%

Units mA, % 4-20, %10-50

► mA Input

Input Resistance < 17.2 Ω

Voltage Burden @ 50mA < 0.86 V

Voltage Burden @ 20mA < 0.35 V

► HART mA Input

HART Resistance 250 Ω

Voltage (V) Input

► Accuracy

$\pm(0.015\% \text{ of reading} + 0.002\text{VDC})$

Accuracy specifications include all effects of linearity, hysteresis, repeatability, temperature, and stability within the specified operating temperature range for one year.

Note: Exposure to environmental extremes of temperature, shock, and/or vibration may warrant a more frequent recertification period.

► Ranges, Resolutions, and Units

Range 0 to 28VDC

Max Allowable Voltage..... 30VDC

Resolution..... 0.001VDC

Units VDC

Switch Test

► Switch Detection

Switch States Dry Contact

Closed State Resistance $< 10 \Omega$

Open State Resistance $> 10 \text{M}\Omega$

TEMPERATURE (RTD100) MODULE INSTRUCTIONS

Your nVision has the ability to measure temperature very accurately if populated with an RTD100 module. With this system you may connect your resistance temperature detector (platinum RTD) or platinum resistance thermometer (PRT) to the nVision using the provided IP67 rated connector system (P/N: 3953). Once the sensing element is connected, you may display the temperature reading in your desired unit. The nVision can also measure electrical resistance (Ω) to help in troubleshooting your resistance based sensing element.

Temperature Coefficient of Resistance (TCR)

Your nVision comes pre-loaded with several common RTD sensing element TCR values with the appropriate Callendar-Van Dusen Coefficients to convert your resistance measurement to the appropriate temperature measurement. The available 100 Ω platinum RTD TCRs are:

- Pt100 (385) Euro
- Pt100 (3911) US
- Pt100 (3926)

 Simply select the desired TCR or coefficient values in CrystalControl for use on the nVision. You may also view the Summary page to confirm you have selected the correct setting for your sensing element.

Connecting your RTD to the RTD100 Module

Your nVision RTD100 module has been shipped with an IP67 rated, M8 connector (P/N: 3953). The terminal block based connector allows you to attach your RTD sensor for 2-, 3-, or 4-wire connections. Care must be taken to install the RTD connector shell properly to ensure the robust IP67 sealing.

1 RTD sensor element connection requirements:

- 100Ω Platinum RTD with:
 - TCR of 385, 3926, or 3911
 - Cable diameter of 3.5 to 5.0mm [0.14 to 0.2 inches] with smooth, continuous covering adequate for IP67 sealing.
 - Stranded conductor cross section of 0.14 to 0.5mm² [0.0002 to 0.0008 in²].

2 For your ease in sourcing this connector, the following sources of supply may be used:

- Phoenix Contact:
 - Order Number: 1501265, or Part Number: SACC-M8MS-4CON-M-SW
- Binder:
 - Part Number 99-3383-100-04

3 RTD sensor element cable preparation:

- (a) Strip approximately 12.0mm [0.5 in] outer insulation from RTD cable.
- (b) Strip the individual RTD element sense wires approximately 4.0mm [0.16 in].
- (c) Install 3 piece sealing system onto the cable assembly. Take care to place parts in proper order and orientation.

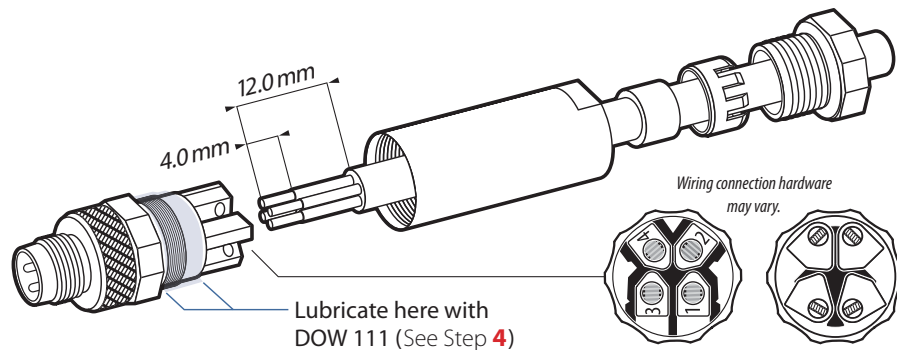

- (d) Install your RTD sense element wires as appropriate for your configuration (see illustration below), and tighten the set screws.
- (e) Confirm correct orientation of element wires in connected state.

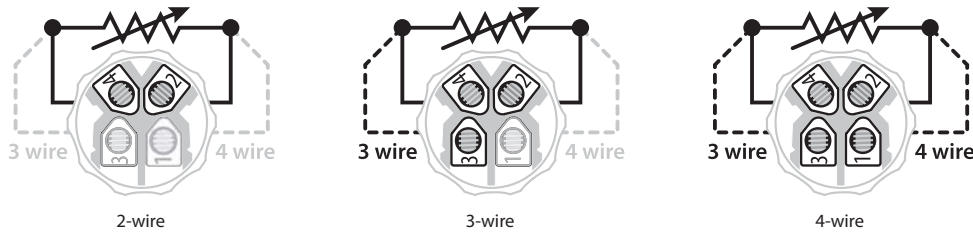

- 4** Lubricate o-ring and thread system with Dow 111 or equivalent in location near terminal block as required to prevent water intrusion when connector shell is installed. Thread shell in place until tight.
- 5** Leak check to ensure water tight seal. If any leaking occurs, rework and lubricate as necessary. If leak-free, your RTD sensor is ready to use with the nVision Reference Recorder.

Note:  Your nVision has the RTD100 module TCR set to Pt100 (385) Euro. Modify this setting in CrystalControl as needed.

Modifying the Base Resistance (R₀)

As with any measurement device, it is possible the sensor will drift over time or from extreme temperatures. The nVision allows a user defined offset to the 100Ω base resistance experienced at 0°C if needed to improve the performance of your sensor.

Differential Temperature

The Tare function also allows you to equalize the differential temperature or resistance measurements to improve your measurement accuracy. Therefore, if you apply the same temperature or resistance signal to both RTD100 sensor elements simultaneously you should have a ΔT reading of zero. Due to the allowable error tolerance for each module, the reading may not be zero. The Tare function allows you to normalize both of these readings so that the ΔT reading is zero. Therefore, you will have a much more accurate ΔT reading than you normally would have if this process was not completed. Note that generally accepted lab practices should be followed when trying to establish a common temperature measurement on two independent sensors.

The Tare should be reestablished every time you are at a new temperature or resistance. For instance if your ΔT reading has 0.2°C of Tare at 220°C, when you return to ambient conditions this 0.2°C of Tare will remain in place on your ΔT reading until cleared with the button.

Differential Temperature Measurement Uncertainties without Tare

The RTD100 module is capable of both temperature and resistance measurements. The resistance measurement uncertainty can be calculated by combining the uncertainties of the two resistance measurements. The following formulas describe the combined uncertainty of two RTD100 Module resistance measurements.

To calculate the total uncertainty of the differential temperature measurement ($U_{\Delta T}$) you must combine the uncertainties of the upper and lower RTD100 and RTD sensor element systems (U_{system}).

Calculate U_{system} for the upper and lower RTD100 and RTD sensor element systems:

$$U_{system} = \sqrt{U^2_{RTD100} + U^2_{RTD\ Sensor\ Element}}$$

Calculate the total differential pressure uncertainty:

$$U_{\Delta T} = \sqrt{U^2_{system\ upper} + U^2_{system\ lower}}$$

Differential Temperature Measurement Uncertainties with Tare

To determine the improved Tare function uncertainties it may be necessary to conduct an analysis of the application. A suggested method of analysis is to Tare the ΔT reading when measuring the isolated temperature at site A. Without resetting the Tare, measure the isolated site B temperature and determine the error in your ΔT reading. Comparing these results would represent the full range of Δt readings that you would see in your application.

TEMPERATURE (RTD100) MODULE SPECIFICATIONS

Accuracy

0% to 100% of Full Scale $\pm(0.015\% \text{ of reading} + 0.02\Omega)$

Accuracy specifications include all effects of linearity, hysteresis, repeatability, temperature, and stability within the specified operating temperature range for one year.

Note: Exposure to environmental extremes of temperature, shock, and/or vibration may warrant a more frequent recertification period.

Ranges, Resolutions, and Units

Range 0 to 400 Ω for use with 100 Ω PRT (platinum resistance temperature detectors)

Resolution 0.01 on all scales

Units $^{\circ}\text{C}$, K, $^{\circ}\text{F}$, R, and Ω

Wiring Types and TCRs

Wiring Types 2-, 3-, or 4-wire

Available TCR Selections: 0.00385, 0.003911, or 0.003926

Connection

► RTD Sensor Connector Interface

P/N 3953: RTD Connection Kit (one IP67 terminal block connector) (equivalent to Phoenix Contact Order Number: 1501265, or Part Number: SACC-M8MS-4CON-M-SW, or Binder P/N: 99-3383-100-04)

Cable Diameter 3.5 to 5.0mm [0.14 to 0.012 in] with smooth, continuous covering adequate for IP67 sealing

Stranded Conductor Cross Section 0.14 to 0.5mm² [0.0002 to 0.0008 in²]

Logging Interval

Fastest Logging Interval. 5 readings per second.

Note: Although the nVision logging interval may be set to a faster rate, the RTD100 module will update the reading at 5 times per second.

ATEX and IECEx Scheme Entity Parameters

The RTD100 module has these specific input entity parameters:

U _i = 0	U _o = 9.73 V
i _i = 0	i _o = 1.6642 A
P _i = 0	P _o = 1.1 W
	C _o = 0.5 uF
	L _o = 12 uH*

* Total cable inductance between all modules

RESISTANCE TEMPERATURE DETECTORS (RTD)

Resistance Temperature Detectors (RTDs) are temperature sensors that contain a resistor that utilize the predictable change in electrical resistance of particular materials over temperature. Platinum elements have been used for many years in laboratories and industrial processes, and have a reputation for range, linearity, repeatability, and stability. The selection strengths of RTDs, or sometimes called PRT (platinum resistance thermometer) are their wide temperature range (approximately -200 to 850°C), accuracy (better than thermocouples), good interchangeability between similar sensors, and long-term stability.

Callendar-Van Dusen Equation

The relationship between temperature and resistance is given by the Callendar-Van Dusen equation.

$$RT = R_0 [1 + AT + BT^2 + CT^3 (T-100)] \text{ for } (-200^\circ\text{C} < T < 0^\circ\text{C})$$

$$RT = R_0 [1 + AT + BT^2] \text{ for } (0^\circ\text{C} \leq T \leq \text{°C of Upper Temperature Range listed below})$$

Where: RT = the resistance at temperature, T; R₀ = the resistance at 0°C; and the constants A, B, and C dependent upon RTD selected (TCR).

nVision (TCR) Temp. Coefficient of Resistance	Temperature Range	Base Resistance	TCR (Ω/Ω/°C)	Sensitivity (avg. Ω/°C, 0 to 100 °C)	A (°C ⁻¹)	B (°C ⁻²)	C (°C ⁻⁴)
Pt100 (385) Euro	-200 to 850°C (-328 to 1562°F)	100Ω at 0°C	0.00385	0.385	3.9083 x 10 ⁻³	-5.7750 x 10 ⁻⁷	-4.183 x 10 ⁻¹²
Pt100 (3926) US	-259 to 1235°C (-434 to 2255°F)	100Ω at 0°C	0.003926	0.3926	3.9848 x 10 ⁻³	-5.87 x 10 ⁻⁷	-4.0 x 10 ⁻¹²
Pt100 (3911)	-259 to 630°C (-434 to 1166°F)	100Ω at 0°C	0.003911	0.3911	3.9692 x 10 ⁻³	-5.8495 x 10 ⁻⁷	-4.2325 x 10 ⁻¹²

RTD100 System Measurement Uncertainties

To understand the total system measurement uncertainty of the temperature measurement you must consider both the nVision and the RTD sensing element uncertainties utilized in the test application. Since the uncertainties of nVision and the sense element are independent of each other, they must be combined properly with the preferred square root of the sum of the squares¹ (or “root sum squares”) method.

The proper selection of the RTD sensing element is very important as the error associated with this device is the majority of the overall system measurement uncertainty. IEC 751 is the standard that defines the temperature versus resistance for 100Ω, 0.00385 Ω/Ω/°C platinum RTDs. IEC 751 defines two classes of RTDs: Class A and B. Class A RTDs operate over the -200 to 630°C range versus -200 to 800°C for the Class B elements. For example, the Class A uncertainty is about half that of the Class B elements as illustrated in the following table.

Tolerance Class	Temperature Deviation	Accuracy at 0°C	Standard
Class A	$\pm(0.15 + 0.002*t)^{\circ}\text{C}$	100.00 \pm 0.06 Ω	DIN/IEC751
Class B	$\pm(0.3 + 0.005*t)^{\circ}\text{C}$	100.00 \pm 0.12 Ω	DIN/IEC751

¹ We recommend combining system expanded uncertainties in accordance with recommendations outlined in ISO “Guide to Expression of Uncertainty in Measurement (GUM).

The uncertainties typically reported by us represent expanded uncertainties using a coverage factor k=2 to approximate a 95% confidence level. The typical method of combining uncertainties is the root sum squares of the individual contributing uncertainties and will be calculated as such for the example shown.

Temperature	nVision Uncertainty		Class A				Class B			
			Class A Uncertainty		nVision + Class A Uncertainty		Class B Uncertainty		nVision + Class B Uncertainty	
°C	$\pm\Omega$	$\pm^{\circ}\text{C}$	$\pm\Omega$	$\pm^{\circ}\text{C}$	$\pm\Omega$	$\pm^{\circ}\text{C}$	$\pm\Omega$	$\pm^{\circ}\text{C}$	$\pm\Omega$	$\pm^{\circ}\text{C}$
-200	0.02	0.05	0.24	0.55	0.24	0.55	0.56	1.30	0.56	1.30
0	0.04	0.09	0.06	0.15	0.07	0.17	0.12	0.30	0.12	0.31
200	0.05	0.13	0.2	0.55	0.21	0.56	0.48	1.30	0.48	1.31
400	0.06	0.17	0.33	0.95	0.33	0.96	0.79	2.30	0.79	2.31
600	0.07	0.21	0.43	1.35	0.44	1.37	1.06	3.30	1.06	3.31
800	0.08	0.25	0.52	1.75	0.53	1.77	1.28	4.30	1.28	4.31







Power

BATTERY POWER (REFERENCE RECORDER ONLY)



Power Icon States

The nVision Reference screen display has the following power icon states:

Power Icon Key - nVision Reference Recorder						
Icon						
Description	External Power (USB)	100%	75%	50%	25%	0%*
		Power Remaining				

* Replace Batteries or connect to USB Power

The  icon will appear when the batteries are exhausted and will need to be changed to ensure full functionality of the nVision. Continued use will further drain the batteries to a non-operational state where the message “Replace Batteries” will appear across the display. From this state, the only operational parameter will be the power button. After “Replace Batteries” appears, no measurements will be possible until the batteries are replaced, however, the recorded data will be preserved.

CAUTION: Never remove battery or USB power when Recording.

WARNING: Do not remove or change the batteries in a hazardous atmosphere.

Automatic Shutoff Timer and Low Power Mode



The Automatic Shutoff Timer is set in CrystalControl. During normal (non-recording) operation, the nVision will power down when the Automatic Shutoff Timer runs out. The Automatic Shutoff timer will not shut off your nVision while recording. Instead, The Low Power Mode screen will appear after the Automatic Shutoff Timer runs out. To return to normal operation simply press the (select) button.

Extending Battery Life and Low Power Modes

 Note that the nVision reference recorder has many customizable battery saving features available to you for optimization in CrystalControl.

► Low Power Mode

You may extend battery life substantially by slowing down your Logging Interval (recording rate), reducing the *Automatic Shutoff* and *Backlight Shutoff* times, or reducing the number of screens enabled.

► Ultra Low Power Mode

During a recording with a Logging Interval of 1 reading/minute or slower, your nVision will enter *Ultra-Low Power Mode* after the first reading elapses AND the Automatic Shutoff Timer runs out. The battery conservation measures used in Ultra-Low Power Mode allow the nVision to enter a deep-sleep condition between data readings

Note: The Backlight Shutoff is set separately in CrystalControl. It is unaffected by the *Automatic Shutoff Timer*, *Low Power Mode*, or *Ultra Low Power Mode*.

Battery Replacement

The nVision uses four AA batteries. Unscrew the four captive screws (knurled Phillips head) to gain access to the battery compartment. Replace the batteries taking care to note polarity for their proper installation. After replacing the batteries and reinstalling the power module, the nVision will start operating immediately (without having to press the button). This indicates that a complete reset has occurred, and is normal. Verify the battery module is properly sealed and installed to maintain your IP67 rating. Failure to properly seal the battery compartment may allow water damage that could permanently compromise the nVision. IP67 rating will be void if nVision is operated without 4AA power module in place.

! WARNING: Do not remove or change the batteries in a hazardous atmosphere.

Battery Power Module (4AA) Specification

Batteries. Four (4) size AA (LR6) batteries.

! WARNING: Do not remove or change the batteries in a hazardous atmosphere.

► The nVision is Intrinsically Safe only if powered by one of the following battery types:

Approved Battery Type	Ta=	Marking
Rayovac Max Plus 815	-20 to 50° C	Ex ia IIB T4 Ga
Duracell MN1500	-20 to 45° C	
Energizer E91, EN91*	-20 to 50° C	Ex ia IIB T3 Ga
Duracell MN1500		

Replace batteries with approved type in non-hazardous locations only

* Energizer is manufactured by Energizer Holdings, Inc., and the Eveready Battery Company, Inc.

Many other battery types and models have been tested but failed to meet the requirements for Intrinsic Safety—do not assume other models are equivalent. The nVision can be operated and powered from the mini-USB serial interface.

! WARNING: Do not use the mini-USB serial interface in a hazardous atmosphere.

► The nVision is CSA certified only if powered by one of the following battery types:

Approved Battery Type	Ta=	Marking
Rayovac Max Plus 815	-20 to 50° C	Class I, Division 1, Grp C, D T4
Duracell MN1500	-20 to 45° C	
Energizer E91	-20 to 50° C	Class I, Division 1, Grp C, D T3B
Energizer EN91		Class I, Division 1, Grp C, D T3A
Duracell MN1500		Class I, Division 1, Grp C, D T3C

Replace batteries with approved type in non-hazardous locations only

► **Battery Life**

Settings such as Auto Shutoff, Logging Interval, and Backlight Shutoff greatly vary battery life.

Standard200 hours (typical) (1 reading per second recording, auto shutoff 20 minutes).

Ultra Low Power60 Days (typical) (2 installed modules, 1 reading per 5 minute recording interval with Auto Shutoff enabled and 23° C ambient temperature).

USB POWER (REFERENCE RECORDER ONLY)



The USB connected/powered icon (🔌) will become active when connected. The mini USB connection will power the nVision with and without the battery pack installed. Since the power module consists of alkaline AA batteries, they will not be recharged by the USB device.

IP67 rating will be void if nVision is operated without 4AA power module in place. Therefore, if you desire to power the nVision with USB it is recommended to install the 4AA power module (with or without batteries) to protect the reference recorder from the elements.

nVision under USB power consumes less than 100mA.

RESET (REFERENCE RECORDER ONLY)



If for some reason the nVision needs to be reset, remove the battery pack and USB power for at least one minute, then reinstall. If the reset is successful, the nVision will start operating without pressing the power button when the power pack is reinstalled.

! WARNING: Do not remove or change the batteries in a hazardous atmosphere.

Safety and Certifications

HAZARDOUS LOCATIONS



Note: The approvals apply only to the nVision Reference Recorder.

The nVision reference recorder includes the following Intrinsic Safety approvals:

II 1G Ex ia IIB T4 Ga -or- Ex ia IIB T3 Ga

Ta = -20C to 50C or -20C to 45C (depending on type of approved battery used)

See the [Approved Batteries section](#) for more details



Intrinsically Safe and Non-incendive for Hazardous Locations:

Class I, Division 1, Groups C and D, Temperature Code T4 / T3A / T3B / T3C.

SIRA 09ATEX2008X

This product conforms to the following standards:

EN60079-0: 2006 | EN60079-11: 2007 | EN60079-26: 2007



IECEx SIR09.0053X

This product conforms to the following standards:

IEC 60079-0: 2004 | IEC 60079-11: 2006 | IEC 60079-26: 2006

All module entity parameters may be found under the specific module specification section.

WARNINGS: The following warnings apply to the Reference Recorder:

- The mini USB B connector shall not be used within the hazardous atmosphere. It shall be used in the non-hazardous atmosphere with either “Safety Extra Low Voltage Circuits” (SELV) or “Protective Extra Low Voltage Circuits” (PELV). The USB connector has an Um of 6V.
- Substitution of components may impair intrinsic safety.
- Replace batteries with approved type in non-hazardous locations only.
- Parts of the enclosure may generate an ignition-capable level of electrostatic charge under certain extreme conditions. The user should ensure that the equipment is not installed or used in a location where it may be subjected to external conditions, which might cause a build-up of electrostatic charge on non-conducting surfaces. Additionally, cleaning of the equipment should be done only with a damp cloth.

CERTIFICATIONS

The nVision has been tested and certified to comply with a variety of international standards.



We declare that the nVision is in accordance with the ATEX Directive, the Electromagnetic Compatibility Directive, and the Pressure Equipment Directive per our declaration(s).



The nVision is approved for use as a portable test instrument for Marine use and complies with Det Norsjke Veritas’ Rules for Classification of Ships, High Speed & Light Craft and Offshore Standards.



ATEX EC Declaration of Conformity

Note: These approvals apply only to the nVision Reference Recorder.

DECLARATION OF CONFORMITY

In accordance with the ATEX Directive 94/9/EC

Manufacturer's Name: Crystal Engineering Corporation
An AMETEK Inc. company

Manufacturer's Address: 708 Fiero Lane, Suite 9
San Luis Obispo, CA 93401
USA

Declares under sole responsibility that the product as originally delivered

Product Name: Reference Recorder
Model Number: nVision Series
Product Options:

Complies with the essential requirements of the following applicable European Directives, and carries the CE marking accordingly:
ATEX Directive 94/9/EC

And conforms with the following product standards:

Marking	II 1G Ex ia IIB T4 Ga, Ta = -20C to 50C, Rayovac Max Plus 815 II 1G Ex ia IIB T4 Ga, Ta = -20C to 45C, Duracell MN1500 II 1G Ex ia IIB T3 Ga, Ta = -20C to 50C, Energizer E91, EN91 II 1G Ex ia IIB T3 Ga, Ta = -20C to 50C, Duracell MN1500
Standard	EHSR The EN 60079-0:2009 harmonized standard has been compared to the standard used for certification purposes and no changes in the "state of the art" apply to the equipment. The EN 60079-11:2012 harmonized standard has been compared to the standard used for certification purposes and no changes in the "state of the art" apply to the equipment. Harmonized Harmonized (used for guidance in respect of marking)
EN 60079-0: 2006	
EN 60079-11: 2007	
EN 60079-26: 2007 IEC 60079-0: 2007	
EC-Type Examination Certificate	Sira 09 ATEX 2008 X Sira Certification Service, Notified Body 0518 Rake Lane, Eccleston, Chester, CH4 9JN England

I hereby declare that the equipment named above has been designed to comply with the relevant sections of the above referenced specifications. The unit complies with all essential requirements of the Directives

USA Signatory: Division Vice President & Crystal Business Manager David K Porter, P.E. Crystal Engineering Corporation, an AMETEK Inc. company 708 Fiero Lane, Suite 9, San Luis Obispo, CA 93401, USA +1 805 595 5477	European Signatory: Division Vice President & Business Unit Manager Joel Frie AMETEK Denmark A/S Gydevang 32-34, 3450 Allerød, Denmark +45 4816 8000
---	---

4 April 2013



PED EC Declaration of Conformity

Note: These approvals apply to both the nVision Reference Recorder & Lab Reference.



DECLARATION OF CONFORMITY

According to ISO/IEC 17050-1:2004

Manufacturer's Name: Crystal Engineering Corporation
An AMETEK Inc. company

Manufacturer's Address: 708 Fiero Lane, Suite 9
San Luis Obispo, CA 93401
USA

Declares under sole responsibility that the product as originally delivered

Product Name:	nVision Series Reference Recorder nVision Series Lab Reference CPF Series Fittings and Hoses APM Advanced Pressure Module	XP2i Series and XP2i-DD Series Digital Pressure Gauge 30 Series and IS90 Series Pressure Calibrator M1 Series Pressure Gauge HPC40 Series Pressure Calibrator
----------------------	--	--

Complies with the essential requirements of the following applicable European Directives, and carries the CE marking accordingly:
Pressure Equipment Directive 97/23/EC

Have been designed and manufactured to the following

Product and Pressure Range	Description	CE Mark
Pressure gauges, calibrators, and recorders (pressure accessories per guideline 1/6)	The above listed pressure gauges, calibrators and reference recorders are designed and manufactured in accordance with applicable portions of Annex I, Essential Safety Requirements, and sound engineering practices. These pressure gauges or calibrators (classified as pressure accessories per guideline 1/6) have a volume (V) of less than 0.1 liter (Article 3, 1.1.(a) first indent, Group 1 fluids).	CE Mark
Maximum Allowable Pressure (PS) ≤ 200 bar (2 900 psig)	All pressure gauges, calibrators and reference recorders for use on gases or liquids less than or equal to 200 bar (2 900 psig) are not subject to the essential requirements of the directive 97/23/EC (PED, Annex I) will be classed as Sound Engineering Practice (SEP), and shall not have the CE mark applied.	No
Maximum Allowable Pressure (PS) > 200 bar (2 900 psig)	For pressure gauges, calibrators and reference recorders for use on gases or liquids above 200 bar (2 900 psig) on Class 1 & 2 gases or liquids, Crystal Engineering maintains a technical file in accordance with Annex III, Module A (internal production control) when CE mark is required.	Yes

Note: CPF Hoses (MPH series) not for use with Group 1 fluids and gases

I hereby declare that the equipment named above has been designed to comply with the relevant sections of the above referenced specifications. The unit complies with all essential requirements of the Directives.

USA Signatory: Division Vice President & Crystal Business Manager David K Porter, P.E. Crystal Engineering Corporation, an AMETEK Inc. company 708 Fiero Lane, Suite 9, San Luis Obispo, CA 93401, USA +1 805 595 5477	European Signatory: Division Vice President & Business Unit Manager Joel Frie AMETEK Denmark A/S Gydevang 32-34, 3450 Allerød, Denmark +45 4816 8000
---	---

6 April 2013



EMC EC Declaration of Conformity

Note: These approvals apply only to the nVision Reference Recorder.





DECLARATION OF CONFORMITY
According to ISO/IEC 17050-1:2010

Manufacturer's Name: Crystal Engineering Corporation
An AMETEK Inc. company

Manufacturer's Address: 708 Fiero Lane, Suite 9
San Luis Obispo, CA 93401 USA

Declares under sole responsibility that the product as originally delivered

Product Name: Reference Recorder
Model Number: nVision Series

Complies with the essential requirements of the following applicable European Directives, and carries the CE marking accordingly:

EMC Directive 2004/108/EC

Standard	EHSR
EN 55011:2006/ 55011:2007; +A2: 2007 (CISPR 11:2003)	(1) EN 55011:2009/A1:2010/CISPR 11:2009/A1:2010 harmonized standard has been compared to the standard used for certification purposes and no changes in the "state of the art" apply to the equipment.
EN 61326: 2006	(2) The EN 61326-1:2013 harmonized standard has been compared to the standard used for certification purposes and no changes in the "state of the art" apply to the equipment.

Emissions to Class B – domestic or industrial locations.
Immunity to Table A.1 - portable test and measurement equipment

And conforms with the following product standards:

Standard	Description	Class	Status	EHSR
Pressure Modules (PM)				
EN 55011:2006 (CISPR 11)	Radiated Emissions	Class B	Pass	See (1)
EN 61326-1:2006 (EN 61000-4-2)	Electrostatic Discharge	Criteria A	Pass (3)	See (2)
EN 61326-1:2006 (EN 61000-4-3)	Radiated Immunity	Criteria A	Pass	See (2)
Current & Voltage Module (MA20)				
EN 55011:2006 (CISPR 11)	Radiated Emissions	Class B	Pass	See (1)
EN 61326-1:2006 (EN 61000-4-2)	Electrostatic Discharge	Criteria A	Pass	See (2)
EN 61326-1:2006 (EN 61000-4-3)	Radiated Immunity	Criteria A	Pass	See (2)
Temperature Module (RTD100)				
EN 55011:2006 (CISPR 11)	Radiated Emissions	Class B	Pass	See (1)
EN 61326-1:2006 (EN 61000-4-2)	Electrostatic Discharge	Criteria A	Pass (4)	See (2)
EN 61326-1:2006 (EN 61000-4-3)	Radiated Immunity	Criteria A	Pass	See (2)
Barometric Reference Module				
EN 55011:2006 (CISPR 11)	Radiated Emissions	Class B	Pass	See (1)
EN 61326-1:2006 (EN 61000-4-2)	Electrostatic Discharge	Criteria A	Pass	See (2)
EN 61326-1:2006 (EN 61000-4-3)	Radiated Immunity	Criteria A	Pass	See (2)

(3) Pressure changed value and/or unit reset when ESD was applied to the PM module. (4) Temperature changed value when ESD was applied to RTD100 module.

I hereby declare that the equipment named above has been designed to comply with the relevant sections of the above referenced specifications. The unit complies with all essential requirements of the Directives

USA Signatory:

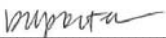

Division Vice President & Crystal Business Manager
David K Porter, P.E.

Crystal Engineering Corporation, an AMETEK Inc. company
708 Fiero Lane, Suite 9, San Luis Obispo, CA 93401, USA
+1 805 595 5477

European Signatory:



Division Vice President & Business Unit Manager
Joël Frié

AMETEK Denmark A/S
Gydevang 32-34, 3450 Allerød, Denmark
+45 4816 8000

13 August 2015



EMC EC Declaration of Conformity

Note: These approvals apply only to the nVision Lab Reference.





DECLARATION OF CONFORMITY
According to ISO/IEC 17050-1:2010

Manufacturer's Name: Crystal Engineering Corporation
An AMETEK Inc. company

Manufacturer's Address: 708 Fiero Lane, Suite 9
San Luis Obispo, CA 93401 USA

Declares under sole responsibility that the product as originally delivered

Product Name: Reference Recorder
Model Number: NL LAB Series

Complies with the essential requirements of the following applicable European Directives, and carries the CE marking accordingly:

EMC Directive 2004/108/EC

Standard	EHSR
EN 55011 (CISPR 11:2003)	(1) EN 55011:2009/A1:2010/CISPR 11:2009/A1:2010 harmonized standard has been compared to the standard used for certification purposes and no changes in the "state of the art" apply to the equipment.
EN 61326: 2006	(2) The EN 61326-1:2013 harmonized standard has been compared to the standard used for certification purposes and no changes in the "state of the art" apply to the equipment.

Emissions to Class A – Industrial locations
Immunity to Table 2 – Industrial electromagnetic environment

And conforms with the following product standards:

Standard	Description	Class	Status	EHSR
EN 55011 (CISPR 11:2003)	Conducted Emissions	Class A	Pass	See (1)
EN 55011 (CISPR 11:2003)	Radiated Emissions	Class A	Pass	See (1)
EN 61326-1:2006 (EN 61000-3-2)	Harmonics		Pass	See (2)
EN 61326-1:2006 (EN 61000-3-3)	Voltage Fluctuations & Flicker		Pass	See (2)
EN 61326-1:2006 (EN 61000-4-2)	Electrostatic Discharge		Pass	See (2)
EN 61326-1:2006 (EN 61000-4-3)	Radiated Immunity		Pass	See (2)
EN 61326-1:2006 (EN 61000-4-4)	Electrical Fast Transient / Burst		Pass	See (2)
EN 61326-1:2006 (EN 61000-4-5)	Surge Immunity		Pass	See (2)
EN 61326-1:2006 (EN 61000-4-6)	Conducted Immunity		Pass	See (2)
EN 61326-1:2006 (EN 61000-4-8)	Magnetic Field Immunity		Pass	See (2)
EN 61326-1:2006 (EN 61000-4-11)	Voltage Dips & Interruptions		Pass	See (2)

I hereby declare that the equipment named above has been designed to comply with the relevant sections of the above referenced specifications. The unit complies with all essential requirements of the Directives

USA Signatory:



Division Vice President & Crystal Business Manager
David K Porter, P.E.

Crystal Engineering Corporation, an AMETEK Inc. company
708 Fiero Lane, Suite 9, San Luis Obispo, CA 93401, USA
+1 805 595 5477

European Signatory:



Division Vice President & Business Unit Manager
Joël Frié

AMETEK Denmark A/S
Gydevang 32-34, 3450 Allerød, Denmark
+45 4816 8000

13 August 2015

MULTI-LANGUAGE SAFETY INSTRUCTIONS

Česky (Czech)

► Bezpečnostní instrukce pro prostředí s nebezpečím výbuchu

- V prostředí s nebezpečím výbuchu nepoužívejte přípojku USB.
- Baterie vyměňujte pouze v bezpečném prostředí. Používejte pouze schválené baterie.
- Za správné použití tohoto přístroje v prostředí s nebezpečím výbuchu odpovídá jeho uživatel.

► Schválené baterie

Přístroj nVision je jiskrově bezpečný pouze pokud je napájen jedním z následujících typů baterií:

Approved Battery Type	Ta=	Marking
Rayovac Max Plus 815	-20 to 50° C	Ex ia IIB T4 Ga
Duracell MN1500	-20 to 45° C	
Energizer E91, EN91	-20 to 50° C	Ex ia IIB T3 Ga
Duracell MN1500		

Replace batteries with approved type in non-hazardous locations only

Mnoho dalších druhů a typů baterií bylo zkoušeno, ale nespĺnily požadavky na jiskrovou bezpečnost - nepředpokládejte, že jiné typy jsou rovnocenné.

Energizer vyrábí Energizer Holdings, Inc. a the Eveready Battery Company, Inc.

Deutsch (German)

► Sicherheitshinweise für explosionsgefährdeten Orten

- Die USB Schnittstellenverbindung darf niemals in einer explosionsgefährdeten Umgebung benutzt werden.
- Der Batteriewechsel muß ausschließlich in sicherer Umgebung mit den vom Hersteller vorgeschriebenen Batterie-Typen erfolgen.
- Der Benutzer ist für den richtigen Umgang des Digitalmanometers in explosions- gefährdeter Umgebung verantwortlich.

► Vom Hersteller vorgeschriebene Batterien

Das nVision ist nur dann eigensicher, wenn die vom Hersteller vorgeschriebenen Batterien eingesetzt werden:

Approved Battery Type	Ta=	Marking
Rayovac Max Plus 815	-20 to 50° C	Ex ia IIB T4 Ga
Duracell MN1500	-20 to 45° C	
Energizer E91, EN91	-20 to 50° C	Ex ia IIB T3 Ga
Duracell MN1500		

Replace batteries with approved type in non-hazardous locations only

Es wurden viele andere Batterietypen vom Hersteller getestet, aber diese haben den Hersteller-Anforderungen für Eigensicherheit nicht entsprochen. Aus diesem Grund dürfen nur vom Hersteller vorgeschriebene Batterie-Typen in das Gerät eingesetzt werden, um die Eigensicherheit zu gewährleisten.

Energizer wird von Energizer Holdings, Inc., und der Eveready Battery Company, Inc. hergestellt.

English (English)

► Safety Instructions for Hazardous Locations

- Do not use the USB connector in a hazardous location.
- Replace batteries in non-hazardous locations, with approved batteries, only.
- It is the users responsibility to understand the proper application of this product in potentially explosive atmospheres.

► Approved Batteries

The nVision is Intrinsically Safe only if powered by one of the following battery types:

Approved Battery Type	Ta=	Marking
Rayovac Max Plus 815	-20 to 50° C	Ex ia IIB T4 Ga
Duracell MN1500	-20 to 45° C	
Energizer E91, EN91	-20 to 50° C	Ex ia IIB T3 Ga
Duracell MN1500		

Replace batteries with approved type in non-hazardous locations only

Many other battery types and models have been tested but failed to meet the requirements for Intrinsic Safety - do not assume other models are equivalent.

Energizer is manufactured by Energizer Holdings, Inc., and the Eveready Battery Company, Inc.

Español (Spanish)

► Instrucciones de seguridad para zonas peligrosas

- No use el conector USB en zona clasificada.
- Cambie las pilas en zona no clasificada, solo con pilas aprobadas.
- Es responsabilidad del usuario comprender la aplicación de este producto en atmósferas potencialmente explosivas.

► Pilas aprobadas

El nVision solo es intrínsecamente seguro si se alimenta con uno de los siguientes tipos de pilas:

Approved Battery Type	Ta=	Marking
Rayovac Max Plus 815	-20 to 50° C	Ex ia IIB T4 Ga
Duracell MN1500	-20 to 45° C	
Energizer E91, EN91	-20 to 50° C	Ex ia IIB T3 Ga
Duracell MN1500		

Replace batteries with approved type in non-hazardous locations only

Se han probado muchos otros tipos de baterías pero han fallado el cumplimiento de los requisitos para la seguridad intrínseca - No asuma que otros modelos son equivalentes.

Energizer está fabricado por Energizer Holdings, Inc., y por Eveready Battery Company, Inc.

Français (French)

► Instructions de sécurité pour les Zones Dangereuses

- Ne pas utiliser le connecteur USB dans une Zone Dangereuse.
- Remplacez les piles dans des Zones non-dangereuses, avec les piles appropriées, uniquement.
- Il est de la responsabilité de l'utilisateur de bien comprendre l'application appropriée de ce produit en atmosphères explosives.

► Piles approuvées

Le nVision est un système à sécurité Intrinsèque seulement s'il est alimenté par un des Piles de type suivant:

Approved Battery Type	Ta=	Marking
Rayovac Max Plus 815	-20 to 50° C	Ex ia IIB T4 Ga
Duracell MN1500	-20 to 45° C	
Energizer E91, EN91	-20 to 50° C	Ex ia IIB T3 Ga
Duracell MN1500		

Replace batteries with approved type in non-hazardous locations only

Beaucoup d'autres types et modèles de Piles ont été examinés mais ne conviennent pas pour répondre aux conditions de sécurité intrinsèque - Ne jamais supposez que d'autres modèles pourraient être équivalents.

Les batteries Energizer sont fabriquées par les sociétés Energizer Holdings inc. et Eveready Battery Inc.

Italiano (Italian)

► Prescrizioni di Sicurezza per Area Pericolosa

- Non utilizzare il connettore USB in Area Pericolosa.
- Sostituire le batterie in Aree non Pericolose e solamente con Batterie approvate.
- E' responsabilità dell'utilizzatore comprendere l'adatta applicazione di questo prodotto in atmosfere potenzialmente esplosive.

► Batterie Approvate

L'nVision è a Sicurezza Intrinseca solo se alimentato da uno dei seguenti tipi di batteria:

Approved Battery Type	Ta=	Marking
Rayovac Max Plus 815	-20 to 50° C	Ex ia IIB T4 Ga
Duracell MN1500	-20 to 45° C	
Energizer E91, EN91	-20 to 50° C	Ex ia IIB T3 Ga
Duracell MN1500		

Replace batteries with approved type in non-hazardous locations only

Molti altri tipi e modelli di batteria sono stati testati ma non sono risultati conformi alle richieste per Sicurezza Intrinseca - non supponete che altri modelli siano equivalenti.

La batteria (Energizer) è fabbricata da Energizer Holdings Inc. e Eveready Battery Company Inc.

Nederlands (Dutch)

► Veiligheidsinstructie voor gebruik in een explosie gevaarlijkeomgeving

- Het gebruik van de USB interface is niet toegestaan in een explosie gevaarlijke omgeving.
- Vervang de batterijen uitsluitend in een niet explosie gevaarlijke omgeving en gebruik alleen batterijen welke zijn goedgekeurd en toegestaan.
- De gebruiker dient er mee bekend te zijn welke gevaren er kunnen optreden in een explosie gevaarlijke ruimte bij gebruik van dit product. Het is de verantwoordelijkheid van de gebruiker om dit product op een juiste wijze toe te passen.

► Batterijen welke zijn goedgekeurd

De nVision is alleen intrinsiek veilig bij gebruik van de volgende batterijen:

Approved Battery Type	Ta=	Marking
Rayovac Max Plus 815	-20 to 50° C	Ex ia IIB T4 Ga
Duracell MN1500	-20 to 45° C	
Energizer E91, EN91	-20 to 50° C	Ex ia IIB T3 Ga
Duracell MN1500		

Replace batteries with approved type in non-hazardous locations only

Bij gebruik van andere niet gecertificeerde batterijen vervalt de intrinsiek veilige ATEX certificering. Een aantal andere batterij merken en types zijn getest maar voldeden niet aan de ATEX voorwaarden voor intrinsieke veiligheid, U mag er daarom niet van uitgaan dat andere equivalente types wel geschikt zullen zijn.

Energizer wordt gefabriceerd door Energizer Holdings, Inc en de Eveready Battery Company, Inc

Polski (Polish)

► Instrukcja Bezpieczeństwa Dla Srefty Zagrożonej Wybuchem

- Połączenie USB może być używane tylko poza strefą zagrożenia wybuchem.
- Wymiana baterii tylko poza strefą zagrożenia wybuchem, używać tylko zatwierdzony typ baterii.
- Odpowiedzialnością użytkownika jest używanie tego produktu we właściwy sposób w strefie zagrożonej wybuchem.

► Zatwierdzone baterie

nVision wersja Iskrbezpieczna może być tylko zasilana przez następujące typy baterii:

Approved Battery Type	Ta=	Marking
Rayovac Max Plus 815	-20 to 50° C	Ex ia IIB T4 Ga
Duracell MN1500	-20 to 45° C	
Energizer E91, EN91	-20 to 50° C	Ex ia IIB T3 Ga
Duracell MN1500		

Replace batteries with approved type in non-hazardous locations only

Wiele innych typów i modeli baterii przetestowano lecz nie spełniały wymagań Iskrbezpieczeństwa - nie przyjmuje się że inne modele są równoważne.

Energizer jest produkowany przez Energizer Holdings, Inc. lub przez Eveready Battery Company, Inc.

Suomen Kieli (Finnish)

► Räjähdyksvaarallisten tilojen turvallisuusohjeita

- USB väylää/liitintä EI saa käyttää räjähdysvaarallisissa tiloissa.
- USB väylää/liitintä EI saa käyttää räjähdysvaarallisissa tiloissa. Käytettävä ehdottomasti ja ainoastaan hyväksytyjä paristoja.
- Käyttäjän vastuulla on laitteen käyttö räjähdysvaarallisissa tiloissa. Mittausovellus ja käyttöympäristö on ehdottomasti selvitettävä ennen käyttöä.

► Käyttöön hyväksytyt paristot

nVision mittari on turvallinen määritellyissä räjähdysvaarallisissa tiloissa ainoastaan, kun käytetään seuraavia paristoja:

Approved Battery Type	Ta=	Marking
Rayovac Max Plus 815	-20 to 50° C	Ex ia IIB T4 Ga
Duracell MN1500	-20 to 45° C	
Energizer E91, EN91	-20 to 50° C	Ex ia IIB T3 Ga
Duracell MN1500		

Replace batteries with approved type in non-hazardous locations only

Monia muita paristotyyppäjä on testattu, mutta on osoittautunut, etteivät ne täytä räjähdysvaarallisten tilojen vaatimuksia.

Energizer tuotemerkkiä valmistaa Energizer Holdings, Inc., ja Eveready Battery Company, Inc.

Support

TROUBLESHOOTING

The nVision is a very high performance reference recorder. Due to the high resolution of this product, you may observe conditions that appear to be defects in the product, but are in fact a result of being able to read and measure pressure to a degree not possible with other instruments.

Noisy or unstable reading when used with fluids

When calibrating or comparing the indicated pressure from an nVision against a hydraulic deadweight tester or piston gauge, the reading on the nVision may appear unstable—the least significant digit jumps up and down several counts.

► **Reason**

Gas (usually air) is trapped in the line between the nVision and the deadweight tester. What is actually happening is the mass is oscillating up and down, and the combination of gas and fluid is acting like a spring. At higher pressures (above 2000 psi, typically) this may eventually diminish, as the gas dissolves into the fluid.

► **Solution**

Evacuate all tubing with a vacuum pump before introducing fluid into the system.

Non-repeatability of pressure measurements

When checking the gauge against a hydraulic deadweight, increasing pressure measurements do not match decreasing pressure measurements.

► **Reason**

As in the previous note, gas has dissolved into the hydraulic fluid. When decreasing the pressure, the dissolved gas then leaves the fluid, but at an uneven rate, so a small pressure differential (due to fluid head pressure) may exist between the reference deadweight and the gauge being tested.

► **Solution**

Evacuate all tubing with a vacuum pump before introducing fluid into the system.

Slow return to zero and/or non-repeatability of pressure measurements

► **Reason**

Pressure port is obstructed.

► **Solution**

Clean with low pressure fluid. Do not touch diaphragm as damage will result.

Error 1 displayed

► Reason

The nVision checks the integrity of internal calibration coefficients every time it's turned on. If any coefficients have been corrupted in any way, "Error 1" is displayed.

► Solution

Contact factory for instructions on how to restore the memory to the original factory settings.

Error 2 displayed

► Reason

The nVision has tried to display a number too large for the display (i.e., more than 6 digits). May be due to an electrical malfunction or numerical error.

► Solution

Contact factory for further instructions.

Error 5 or Error 6 displayed

► Reason

The nVision pressure module (PM) is exhibiting out of normal operating condition behavior.

► Solution

Contact factory for module replacement.

Error 7 displayed

► Reason:

The nVision has lost communication with one or both of your modules.

► Solution

It may be possible to recover from this condition by removing and reconnecting your modules using the Module Installation Instructions in this manual. This may happen if you change modules but do not remove and replace the 4AA, USB, or AC Power to the unit to force a complete reset of the product. Once this is done the module should be recognized properly. If unsuccessful in resolving the issue, contact factory for module replacement.

Date and Time are incorrect

► Reason

The nVision has its date and time synchronised to computers located in our factory.

► Solution

 Connect to CrystalControl on a computer with the correct date and time settings you desire. During the connection process, the nVision will be synchronized to the local time.

CALIBRATION

If adjustment is required, we recommend returning the nVision or separate modules to the factory. Factory service offers benefits you won't find anywhere else. Factory calibration tests your nVision at a variety of temperatures utilizing NIST traceable standards, resulting in calibration certificates that provide performance data over temperature. Our calibration facilities are A2LA accredited to ISO 17025:2005 & ANSI/NCCL Z540-1-1994. A2LA is internationally recognized as an accreditation body by the International Laboratory Accreditation Cooperation, ILAC. Furthermore, upgrades may be available to add or enhance operating features. We designed the product to last, and we support it so that you can get the most from your investment.

Under normal operating conditions, we recommend the nVision be calibrated on an annual basis. Your quality system may require more or less frequent calibration, or your experience with the gauge, or operating environment may suggest longer or shorter intervals.

Although we prefer that you return the nVision to us for calibration, ordinary recertification and/or adjustments may be performed by any qualified personnel with appropriate training and equipment. The following instructions are ONLY intended for such qualified personnel with appropriate test equipment. We recommend that the calibration standards used have a minimum rated accuracy of 0.008% of reading, or equivalent in terms of percent of full scale. This level of accuracy requires the use of piston (deadweight) gauges or very high performance pressure controllers.

CRYSTALCONTROL There are no internal potentiometers. The nVision contains a "span" factor (userspan), set to approximately 1 (as shipped from the factory). As components age this may need to be changed to a value slightly higher or lower, to slightly increase or decrease all readings. This adjustment can be made with a computer through CrystalControl.

Calibration for Pressure Modules (PM)

CRYSTALCONTROL "Zero" the nVision, then record displayed pressure for two or more pressure points. Determine if the nVision would benefit from an overall increase or decrease of the indicated pressures. Adjust userspan accordingly and validate results.

Calibration for Barometric Reference Module (BARO)

CRYSTALCONTROL The BARO module can be calibrated by selecting the Edit Calibration Data button while within the BARO Config screen. Enter Userspan and Offset information directly, or you can use the Calibration Wizard to calculate the optimum values for a 1 or 2 point calibration.

- 1 Connect USB power to the nVision and remove the 4AA power module
- 2 Remove the plastic mounting screw and bend the cover to allow access to the small, round, BARO sensor while in the electrically connected state.
- 3 Connect flexible 4.8mm [3/16"] ID tubing from your clean pneumatic calibration reference directly to the BARO sensor.

For NV-LAB calibrations connect the tubing to the back of the product via the supplied barb fitting.

! CAUTION: Do not subject the BARO sensor to pressures less than 700 mbarA (10.153 psiA), or greater than 1100 mbarA (15.954 psiA), as this may cause permanent damage. Use only clean a clean dry pneumatic source.

! CAUTION: Direct contact with the surface of the BARO sensor may cause permanent damage. Direct sunlight on exposed BARO sensor may affect readings slightly.

Calibration for Current, Voltage & Switch Test Module (MA20)

 The MA20 can be calibrated through the use of the span factor (userspan) and the Offset for the current and voltage modes. Record displayed current or voltage for two or more points. Determine if the nVision would benefit from an overall increase or decrease of the indicated reading and modify using the userspan and offset feature of CrystalControl.

To setup the Switch Test feature, select the Setup Wizard button in the MA20 Module Config screen and follow the instructions.

Calibration for Temperature Modules (RTD100)

 The RTD sensor can be calibrated through the use of the span factor (userspan) and the Base Resistance (Ro) at 0°C. Record displayed temperature for two or more temperature points. Determine if the nVision would benefit from an overall increase or decrease of the indicated temperatures and modify using the userspan feature in CrystalControl. It is also possible to modify the RTD sensor resistance reading at 0 to a custom value other than the default value of 100 Ω using the Base Resistance (Ro) at 0°C in CrystalControl. Note, however, that the Ro offset will affect all RTDs used with the nVision and should be used with care.

ACCESSORIES AND REPLACEMENT PARTS



For nVision Reference Recorder

P/N 4547 BARO Calibration Kit

Includes 3/16" calibration hose with fitting coupler.

P/N 4087 Soft Carrying Case

Durable, padded case with separate pockets for your nVision and accessories.

P/N 3985 Protective Boot

Skydrol™ resistant protective boot. Blue.



For nVision Lab Reference

P/N 4302 Rack Mount Kit

Two rack mount ears with required hardware (Blank panel not included).



For Both nVision Lab Reference and Reference Recorder

P/N 3951 USB A to mini USB B Cable

6' [1.8m] USB A to mini USB B Cable.



! WARNING: Do not use USB interface within a hazardous atmosphere (Um = 6V).

P/N 3952 Test Lead Kit (included in MA20)

Two 39" [1m] 2mm banana jack test leads with multi-purpose clip. Black / Red.

P/N 3953 RTD Connection Kit (included in RTD100)

One IP67 terminal block connector (RTD Module or RTD Sense Element not included).

CONTACT US

Phone(805) 595-5477
Toll-Free(800) 444-1850
Fax(805) 595-5466
Emailcrystal@ametek.com
Web.....ametekcalibration.com

If calling, have ready the model number, serial number, date of purchase, and reason for return. You will receive instructions for returning the device to us.

TRADEMARKS

This manual contains the following third-party trademarks, both registered and unregistered. All marks are the property of their respective companies.

Rayovac® and Maximum Plus™Rayovac Corporation
 Duracell®Duracell Inc. Corporation
 Energizer® and EvereadyEveready Battery Company, Inc.
 “Pressure is Our Business” is a registered trademark of Crystal Engineering Corp.

WARRANTY

Crystal Engineering Corporation warrants the nVision Reference Recorder and nVision Lab Reference to be free from defects in material and workmanship under normal use and service for one (1) year from date of purchase to the original purchaser. It does not apply to batteries or when the product has been misused, altered or damaged by accident or abnormal conditions of operation.

Crystal Engineering will, at our option, repair or replace the defective device free of charge and the device will be returned, transportation prepaid. However, if we determine the failure was caused by misuse, alteration, accident or abnormal condition of operation, you will be billed for the repair.

CRYSTAL ENGINEERING CORPORATION MAKES NO WARRANTY OTHER THAN THE LIMITED WARRANTY STATED ABOVE. ALL WARRANTIES, INCLUDING IMPLIED WARRANTIES OF MERCHANTABILITY OR FITNESS FOR ANY PARTICULAR PURPOSE, ARE LIMITED TO A PERIOD OF ONE (1) YEAR FROM THE DATE OF PURCHASE. CRYSTAL ENGINEERING SHALL NOT BE LIABLE FOR ANY SPECIAL, INCIDENTAL OR CONSEQUENTIAL DAMAGES, WHETHER IN CONTRACT, TORT OR OTHERWISE.

Note: (USA only) Some states do not allow limitations of implied warranties or the exclusion of incidental or consequential damages, so the above limitations or exclusions may not apply to you. This warranty gives you specific legal rights and you may have other rights which vary from state to state.



© 2015 Crystal Engineering Corporation
708 Fiero Lane, Suite 9, San Luis Obispo, California 93401-8701

