

User Manual

RFP3000 Series

Real-Time Peak Power RF Sensors



Safety Summary

The following safety precautions apply to both operating and maintenance personnel and must be followed during all phases of operation, service, and repair of this instrument.

WARNING

Before applying power to this instrument:

- Read and understand the safety and operational information in this manual.
- Apply all the listed safety precautions.
- Verify that the voltage selector at the line power cord input is set to the correct line voltage. Operating the instrument at an incorrect line voltage will void the warranty.
- Make all connections to the instrument before applying power.
- Do not operate the instrument in ways not specified by this manual or by B&K Precision.

Failure to comply with these precautions or with warnings elsewhere in this manual violates the safety standards of design, manufacture, and intended use of the instrument. B&K Precision assumes no liability for a customer's failure to comply with these requirements.

Category rating

The IEC 61010 standard defines safety category ratings that specify the amount of electrical energy available and the voltage impulses that may occur on electrical conductors associated with these category ratings. The category rating is a Roman numeral of I, II, III, or IV. This rating is also accompanied by a maximum voltage of the circuit to be tested, which defines the voltage impulses expected and required insulation clearances. These categories are:

Category I (CAT I): Measurement instruments whose measurement inputs are not intended to be connected to the mains supply. The voltages in the environment are typically derived from a limited-energy transformer or a battery.

Category II (CAT II): Measurement instruments whose measurement inputs are meant to be connected to the mains supply at a standard wall outlet or similar sources. Example measurement environments are portable tools and household appliances.

Category III (CAT III): Measurement instruments whose measurement inputs are meant to be connected to the mains installation of a building. Examples are measurements inside a building's circuit breaker panel or the wiring of permanently-installed motors.

Category IV (CAT IV): Measurement instruments whose measurement inputs are meant to be connected to the primary power entering a building or other outdoor wiring.

WARNING

Do not use this instrument in an electrical environment with a higher category rating than what is specified in this manual for this instrument.

WARNING

You must ensure that each accessory you use with this instrument has a category rating equal to or higher than the instrument's category rating to maintain the instrument's category rating. Failure to do so will lower the category rating of the measuring system.

Electrical Power

This instrument is intended to be powered from a CATEGORY II mains power environment. The mains power should be 115 V RMS or 230 V RMS. Use only the power cord supplied with the instrument and ensure it is appropriate for your country of use.

Ground the Instrument

WARNING

To minimize shock hazard, the instrument chassis and cabinet must be connected to an electrical safety ground. This instrument is grounded through the ground conductor of the supplied, three-conductor AC line power cable. The power cable must be plugged into an approved three-conductor electrical outlet. The power jack and mating plug of the power cable meet IEC safety standards.

WARNING

Do not alter or defeat the ground connection. Without the safety ground connection, all accessible conductive parts (including control knobs) may provide an electric shock. Failure to use a properly-grounded approved outlet and the recommended three-conductor AC line power cable may result in injury or death.

WARNING

Unless otherwise stated, a ground connection on the instrument's front or rear panel is for a reference of potential only and is not to be used as a safety ground. Do not operate in an explosive or flammable atmosphere.

WARNING

Do not operate the instrument in the presence of flammable gases or vapors, fumes, or finely-divided particulates.

WARNING

The instrument is designed to be used in office-type indoor environments. Do not operate the instrument

- In the presence of noxious, corrosive, or flammable fumes, gases, vapors, chemicals, or finely-divided particulates.
- In relative humidity conditions outside the instrument's specifications.
- In environments where there is a danger of any liquid being spilled on the instrument or where any liquid can condense on the instrument.
- In air temperatures exceeding the specified operating temperatures.
- In atmospheric pressures outside the specified altitude limits or where the surrounding gas is not air.
- In environments with restricted cooling air flow, even if the air temperatures are within specifications.
- In direct sunlight.

This instrument is intended to be used in an indoor pollution degree 2 environment. The operating temperature range is 0°C to 40°C and 20% to 80% relative humidity, with no condensation allowed. Measurements made by this instrument may be outside specifications if the instrument is used in non-office-type environments. Such environments may include rapid temperature or humidity changes, sunlight, vibration and/or mechanical shocks, acoustic noise, electrical noise, strong electric fields, or strong magnetic fields.

Do not operate instrument if damaged

⚠ WARNING

If the instrument is damaged, appears to be damaged, or if any liquid, chemical, or other material gets on or inside the instrument, remove the instrument's power cord, remove the instrument from service, label it as not to be operated, and return the instrument to B&K Precision for repair. Notify B&K Precision of the nature of any contamination of the instrument.

Clean the instrument only as instructed

⚠ WARNING

Do not clean the instrument, its switches, or its terminals with contact cleaners, abrasives, lubricants, solvents, acids/bases, or other such chemicals. Clean the instrument only with a clean dry lint-free cloth or as instructed in this manual. Not for critical applications

⚠ WARNING

This instrument is not authorized for use in contact with the human body or for use as a component in a life-support device or system.

Do not touch live circuits

⚠ WARNING

Instrument covers must not be removed by operating personnel. Component replacement and internal adjustments must be made by qualified service-trained maintenance personnel who are aware of the hazards involved when the instrument's covers and shields are removed. Under certain conditions, even with the power cord removed, dangerous voltages may exist when the covers are removed. To avoid injuries, always disconnect the power cord from the instrument, disconnect all other connections (for example, test leads, computer interface cables, etc.), discharge all circuits, and verify there are no hazardous voltages present on any conductors by measurements with a properly-operating voltage-sensing device before touching any internal parts. Verify the voltage-sensing device is working properly before and after making the measurements by testing with known-operating voltage sources and test for both DC and AC voltages. Do not attempt any service or adjustment unless another person capable of rendering first aid and resuscitation is present.

Do not insert any object into an instrument's ventilation openings or other openings.

⚠ WARNING

Hazardous voltages may be present in unexpected locations in circuitry being tested when a fault condition in the circuit exists.

⚠ WARNING

Fuse replacement must be done by qualified service-trained maintenance personnel who are aware of the instrument's fuse requirements and safe replacement procedures. Disconnect the instrument from the power line before replacing fuses. Replace fuses only with new fuses of the fuse types, voltage ratings, and current ratings specified in this manual or on the back of the instrument. Failure to do so may damage the instrument, lead to a safety hazard, or cause a fire. Failure to use the specified fuses will void the warranty.

Servicing



Do not substitute parts that are not approved by B&K Precision or modify this instrument. Return the instrument to B&K Precision for service and repair to ensure that safety and performance features are maintained.

For continued safe use of the instrument

- Do not place heavy objects on the instrument.
- Do not obstruct cooling air flow to the instrument.
- Do not place a hot soldering iron on the instrument.
- Do not pull the instrument with the power cord, connected probe, or connected test lead.
- Do not move the instrument when a probe is connected to a circuit being tested.

Compliance Statements



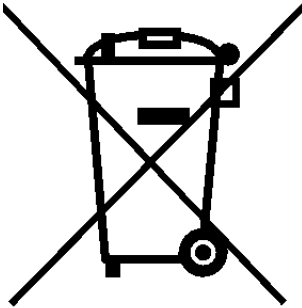







Disposal of Old Electrical & Electronic Equipment (Applicable in the European Union and other European countries with separate collection systems)



This product is subject to Directive 2002/96/EC of the European Parliament and the Council of the European Union on waste electrical and electronic equipment (WEEE), and in jurisdictions adopting that Directive, is marked as being put on the market after August 13, 2005, and should not be disposed of as unsorted municipal waste. Please utilize your local WEEE collection facilities in the disposition of this product and otherwise observe all applicable requirements.



Safety Symbols

Symbol	Description
	indicates a hazardous situation which, if not avoided, will result in death or serious injury.
	indicates a hazardous situation which, if not avoided, could result in death or serious injury
	indicates a hazardous situation which, if not avoided, will result in minor or moderate injury
	Refer to the text near the symbol.
	Electric Shock hazard
	Alternating current (AC)
	Chassis ground
	Earth ground
	This is the In position of the power switch when instrument is ON.
	This is the Out position of the power switch when instrument is OFF.
	is used to address practices not related to physical injury.

Contents

1	General Information	9
1.1	Organization	9
1.2	Product Overview	10
1.3	Architecture	11
1.4	Features	11
1.5	Contents	12
1.6	Dimensions (H x W x L)	12
2	Hardware Overview	13
2.1	Sensor Connections	13
2.2	Status LED Codes	14
2.3	Power Requirements	14
3	Getting Started	15
3.1	Installing the Power Analyzer Software	15
3.2	Connecting the RFP Series RF Power Sensor	16
3.3	Introduction to the Power Analyzer Software	16
3.3.1	Docking Windows	18
3.3.2	Main Application	19
3.3.3	Available Resources Window	19
3.3.4	The Main Toolbox	19
3.3.5	Trace View Window	20
3.3.6	Channel Control Window	22
3.3.7	Time/Trigger Settings Window	23
3.3.8	Marker Settings Window	24
3.3.9	Pulse Definitions Windows	24
3.3.10	Automatic Measurements Windows	25
3.3.11	Display Settings Windows	27
3.3.12	CCDF View Window	28
3.3.13	Statistical Measurements Window	28
4	Operation	29
4.1	Power Analyzer Software	29
4.1.1	Initializing the Software	29
4.1.2	Connecting the RFP Series Sensor	30
4.1.3	Trace View Display	31
4.1.4	Formatting Trace View Display	33
4.1.5	Main Toolbar	34
4.1.6	Time/Trigger Control Window	37
4.1.7	Channel Control Window	41
4.1.8	Automatic Measurements Display	44
4.1.9	Pulse Definition Window	45
4.1.10	Marker Settings Windows	46
4.1.11	Statistical CCDF Graph Display	48
4.1.12	Statistical Mode Control Window	49
4.1.13	Meter View	51
4.1.14	Acquisition Status Bar	53
4.1.15	Archiving Measurement Setups	53
4.2	Multichannel Operation	54
4.2.1	Multichannel Measurement	54
4.2.2	Multichannel Triggering	56
4.2.3	Multichannel Individual Sensor Tabs	58
4.3	Measurement Buffer Mode(API remote programming only)	59

4.3.1	Buffer Overview	59
4.3.2	Measurement Buffer Mode Operation	61
4.3.3	Measurement Buffer Mode User Settings	65
5	Remote Programming	67
5.1	Communication Overview	67
6	Definitions & Measurements	68
6.1	Pulse Measurements	68
6.1.1	Pulse Definitions	68
6.1.2	Standard IEEE Pulse	68
6.1.3	Automatic Pulse Measurements	70
6.1.4	Automatic Pulse Measurement Criteria	71
6.1.5	Automatic Pulse Measurement Sequence	71
6.2	Marker Measurements	74
6.2.1	Average Power Over a Time Interval	75
6.3	Automatic Statistical Measurements	76
7	Maintenance	77
7.1	Safety Recommendation	77
7.2	Cleaning	77
7.3	Inspection and Performance Verification	77
7.4	Connector Care	77
7.5	Software and Firmware Updates	79
7.5.1	Firmware Update Procedure	79
7.5.2	Power Analyzer Software Update Procedure	82
7.5.3	Checking for New Firmwarr After the Initial Installation	84
8	Specifications	87
9	Service Information	89
10	LIMITED THREE-YEAR WARRANTY	90

General Information

The user manual provides the information needed to install, operate and maintain the RFP3000 Sensor Series.

Chapter 1 is an introduction to the manual and the instrument.

1.1 Organization

The manual is organized into seven chapters:

Chapter 1 - **General Information** presents a summary descriptions of the instrument and its principal features, accessories and options. Also included are specifications for the instrument.

Chapter 2 – Hardware Installation provides instructions for unpacking the instrument, setting it up for operation, connecting power and signal cables, and initial power-up.

Chapter 3 - **Getting Started** describes the basic operation of the RFP Series Real-Time Power Sensors and the Power Analyzer Software.

Chapter 4 - **Operation** describes, in detail, the Graphical User Interface (GUI) of the Power Analyzer Software and the RFP Series Real-Time Power Sensors.

Chapter 5 - **Remote Programming** explains the command set and procedures for operating the instrument remotely.

Chapter 6 – Making Measurements provides definitions for key terms used in this manual and on the GUI displays as well as methodologies used to calculate automated pulse, marker and statistical measurements.

Chapter 7 - **Maintenance** includes procedures for installing software and verifying fault-free operation.

1.2 Product Overview

The new RF power measurement line includes 6, 18 and 40 GHz models, and is designed for measurement of wideband modulated signals.

The RFP RF Power Sensors are the latest series of products from BK Electronics that turn your PC or laptop using a standard USB 2.0 port into a state-of-the-art peak power analyzer without the need for any other instrument. Power measurements from the RFP Series RF Power Sensors can be displayed on your computer or can be integrated into a test system with a set of user-defined software functions.

The RFP3000 Power Sensors include the models RFP3006, RFP3008, RFP3018, RFP3118, RFP3040, and RFP3140. Collectively they cover a frequency range of 50 MHz to 40 GHz. Offering broadband measurements with rise times up to 3 ns, time resolution of 100 ps, and video bandwidths up to 195 MHz.

The RFP300 Power Sensors enable rapid pulse integrity determinations. Effective sampling rate is up to one hundred times faster than conventional power meters so finer waveform details are visible. They perform automatic capture of pulse power, overshoot, droop, edge delay and skew timing, and edge transition times.

The RFP3000 Real-Time Power Sensors have exceptional trigger stability of less than 100 ps trigger jitter regardless of the trigger source which yields much greater waveform detail because a stable trigger point yields a stable waveform. Using dedicated trigger circuitry rather than software-based triggering provides precise timestamping of relative trigger-to-sample delay. This precision permits the use of random interleaved sampling (RIS) for repetitive waveforms with resulting effective sampling rate of 10 GS/s which permits accurate, direct measurement of fast timing events without requiring interpolation between samples.

Real Time Power Processing offers new possibilities for power integrity measurements because every pulse is analyzed and none are discarded. Trace acquisition, averaging and envelope times are drastically reduced resulting in simultaneous analysis of average, peak and minimum Power.

The RFP Series Real-Time Power Sensors are supported by the **Power Analyzer Software**, a Windows based software package that provides control and readout of the sensors. It is an easy to use program that provides both time and statistical domain views of power waveforms with variable peak hold and persistence views. Power measurements are supported using automated pulse and statistical measurements, power level and timing markers. The GUI application is easily configured with dockable or floating windows and measurement tables that can be edited to show only the measurements of interest.

The RFP Series Power Sensor Programming Reference provides basic information on using the RFP Series Real-Time Power Sensor Application Programming Interface (API) in an end-user application. The API consists of a Dynamic Link Library, which is required for use of the **Power Analyzer Software**. The API includes a programming reference, as well as code examples for C++, C# and Visual Basic.

The RFP Series Real-Time Power Sensors are ideal for manufacturing, design, research, and service in commercial and military applications such as telecommunications, avionics, RADAR, and medical systems. They are the instrument of choice for fast, accurate and highly reliable RF power measurements, equally suitable for product development, compliance testing, and site monitoring applications.

1.3 Architecture

The Sensor functions as an ultra-fast, calibrated power measurement tool, which acquires and computes the instantaneous, average and peak RF power of a wideband modulated RF signal. The internal A/D converter samples the detected RF signal at up to 100 M samples/second, and a digital signal processor carries out the work required to form the digital samples into a correctly scaled and calibrated trace on the display. Figure 1.1 shows a block diagram of the peak power sensor.

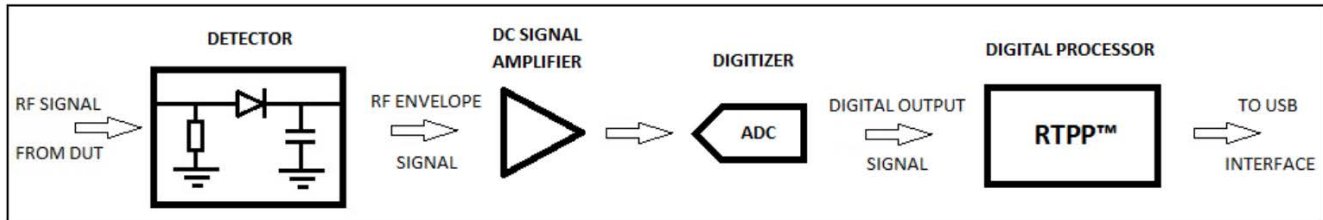

Figure 1.1 Real-Time Power Sensors Block Diagram

The first and most critical stage of a peak power sensor is the detector, which removes the RF carrier signal and outputs the amplitude of the modulating signal. The width of the detector's video bandwidth dictates the sensor's ability to track the power envelope of the RF signal. The picture on the left in Figure 1.2 below shows how a detector with insufficient bandwidth is unable to faithfully track the signal's envelope, therefore affecting the accuracy of the power measurement. The detector on the right has sufficient video bandwidth in order to track the envelope accurately. The fast detectors used in peak power sensors are by their nature non-linear, so shaping procedures within the digital processor must be used in order to linearize their response. When measuring instantaneous peak power, a high sample rate is important in order to ensure that no information is lost. The RFP Series Real-Time Power Sensors have a sample rate of 100 MHz (RFP3000), enabling capture and analysis of power versus time waveforms at very high resolution.

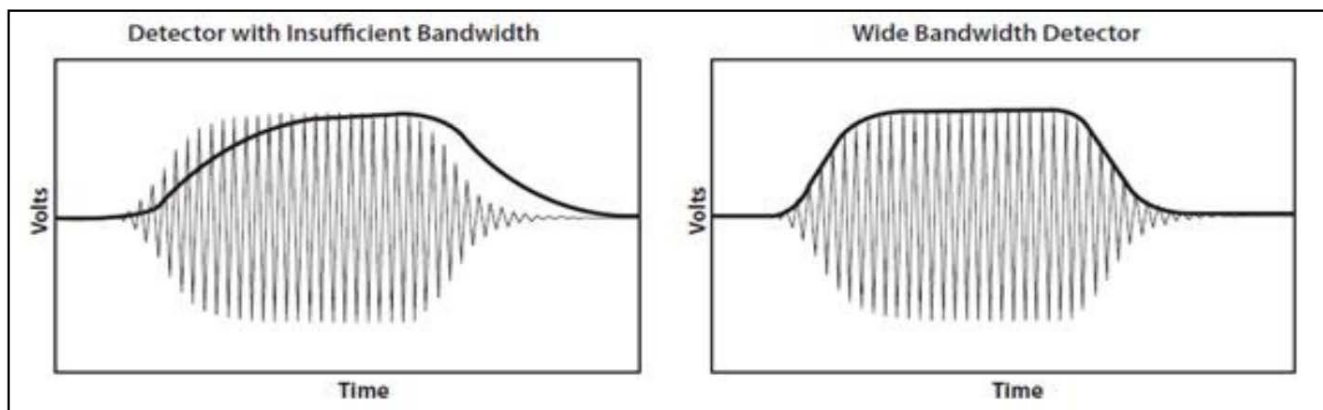

Figure 1.2 Detector Envelope Tracking Response

1.4 Features

- Real-Time Power Processing™
- 16 automated pulse measurements
- Crest Factor and statistical measurements (e.g., CCDF)
- Synchronized multi-channel measurements (up to 8 channels with GUI, >8 with remote control)
- Power Analyzer: advanced measurement and analysis software

1.5 Contents

Please inspect the instrument mechanically and electrically upon receiving it. Unpack all items from the shipping carton, and check for any obvious signs of physical damage that may have occurred during transportation.

Report any damage to the shipping agent immediately. Save the original packing carton for possible future reshipment. Every unit is shipped with the following contents:

- RFP 3000 Series Sensor
- Factory test and calibration certificate
- USB Type-A Cable (6 ft)
- External Trigger Multi-I/O Cable (SMB to BNC)
- Trigger Sync Cable (SMB to SMB) for triggering multiple sensors
- RFP Series Welcome Card containing URL to downloadable Power Analyzer Software, drivers and documentation on BK website

Note:

Ensure the presence of all the items above. Contact the distributor or B&K Precision if anything is missing.

Save the packing material and container to return the instrument, if necessary. If the original materials (or suitable substitute) are not available, contact the distributor to purchase replacements. Store materials in a cool, dry environment.

1.6 Dimensions (H x W x L)

The RFP 3000 Series Sensors dimensions are approximately:

1.7" x 1.7" x 5.7" (4.3 cm x 4.3 cm x 14.5 cm)

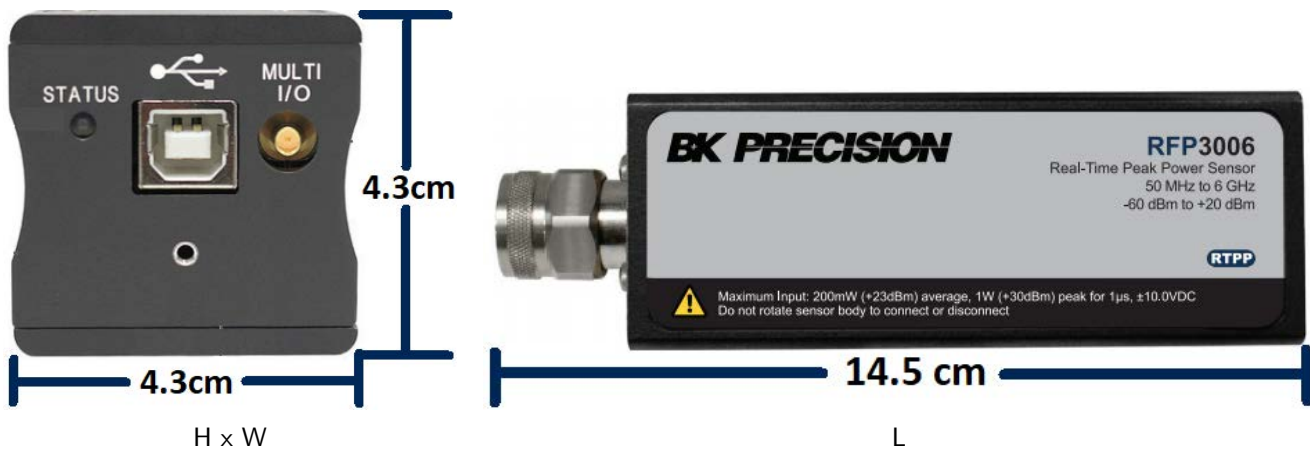

Figure 1.3 Dimensions

Hardware Overview

This section contains power requirements, connection descriptions and preliminary checkout procedures.

2.1 Sensor Connections

The end panel of the RFP Series RF Power Sensor shown in Figure 2.1, has two connectors and the Status LED. The center connector is a USB **Type B** receptacle used to connect the power sensor to the host computer.

The connector labeled Multi I/O is an SMB plug and can serve as a trigger input, status output, or as a trigger synchronization interconnect when multiple power sensors are used.



Figure 2.1 USB Connector and Status LED

Connect the power sensor to your PC through the supplied USB cable. Note that the cable should be secured to the sensor using the captive screw on the USB plug. The power sensor is USB 2.0 compatible. It is recommended that you use the USB cable supplied with your sensor.

Connect the power sensor to RF Source. All RFP Series Sensors models are equipped with a precision Type-N male RF connector. Connect the power sensor to the RF signal to be measured.

Caution:

- Do not rotate the body of the sensor when connecting the sensor to a unit under test (UUT). To avoid internal sensor damage, connect and disconnect the sensor by turning the metal nut only.

NOTICE

- Ensure that you do not apply any excessive force on the sensor once it has been connected.
 - Do not apply RF power levels greater than +20 dBm to the RF input of the sensor.
-

2.2 Status LED Codes

The information labels shown in figure 2.2 on the RF Power Sensor contain information on the maximum power levels the device can handle.

The end panel, shown in figure 2.3, includes a Status LED. The color and flash pattern indicate the sensors status as indicated on the label on the side panel shown.

Top View

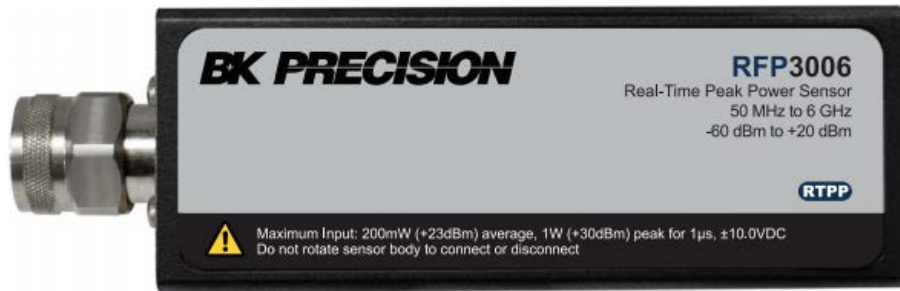

Figure 2.2 Top View

Bottom View



Figure 2.3 Bottom View

2.3 Power Requirements

The RFP3000 Sensors require 2.5 Watts at 5 Volts, this is supplied via a USB port. The power sensor **MUST** be connected to a USB 2.0 port that is able to supply the full 500 mA.

Note:

NOTICE

Usually a USB 2.0 port is capable of supplying 500 mA current through its port. When an unpowered USB hub is used (sometimes the hub is internal), available current may need to be shared between connected devices.

Getting Started

This chapter will introduce the RFP Series RF Power Sensors, and will discuss basic connection and operation. For additional information please see Chapter 4 "**Operation**".

3.1 Installing the Power Analyzer Software

This section describes the installation and use of the Power Analyzer Software for RFP Series RF Power Sensors. Before you start, check your PC for software compatibility.

Note:

NOTICE

Do not connect the power sensor to your PC until you have installed the **Power Analyzer Software**.

The **Power Analyzer Software** requires the following minimum computer characteristics:

Processor	1.3 GHz or higher recommended
RAM	512 MB (1 GB or more recommended)
Operating System	Microsoft® Windows® 10 (64-bit)
Hard-Disk Free Space	Min 1.0 GB free space to install or run
Display Resolution	800x600 (1280x1024 or higher recommended)
Interface	USB 2.0 high speed

Procedure

To install the **Power Analyzer Software**, follow these steps:

1. Download the installation package from the **Docs & Software** tab of the product page on the **BK Precision** website.
2. The installation process is initiated by running "**BPAInstaller.exe**" with admin permissions.
 - When you select install for the first time, read the license agreement, accept it and then click on "Install" in order to proceed with the installation process.
3. By default, the main software application will be installed in the following folder: C:\Program Files (x86)\BKPrecision\Power Analyzer\
 - Once the installation has successfully completed, click the "Close" button to exit the wizard.
4. Double click the Power Analyzer icon on the desktop to launch the application.

3.2 Connecting the RFP Series RF Power Sensor

After unpacking and following the software installation discussed in chapter "[Hardware Overview](#)" and section [Installing the Power Analyzer Software](#), a sensor device can be connected to the USB port of the PC.

When the sensor device is first connected to the USB port, there will be a one-time driver file installation. Wait until Windows OS installs the driver file. An automatic device detection message will appear.

Note:

Older or newer operating system may behave differently. Contact BK Precision if you have a problem.

The Windows pop-up shown in figure 3.1 notifies that the USB driver for **RFP3006 Sensor** has been installed.

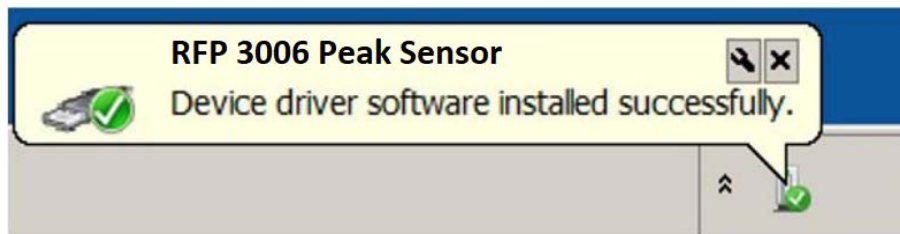

Figure 3.1 USB Driver Installed Notification

3.3 Introduction to the Power Analyzer Software

Upon installing the software, configured the USB drivers and connected the power sensor to the PC. The **Power Analyzer Software** will be ready to take measurements.

Open the **Power Analyzer Software** from the **BK Precision** group in the Windows Start Menu or by double clicking

on the desktop icon



A splash screen will welcome you to the application.



Figure 3.2 Power Analyzer Software Splash Screen

Under the "**Available Resources Window**", a pop up box will appear as below with the list of connected devices name and hardware information. The initial view of the **Power Analyzer Software** is shown in figure 3.3. The display colors may be different.

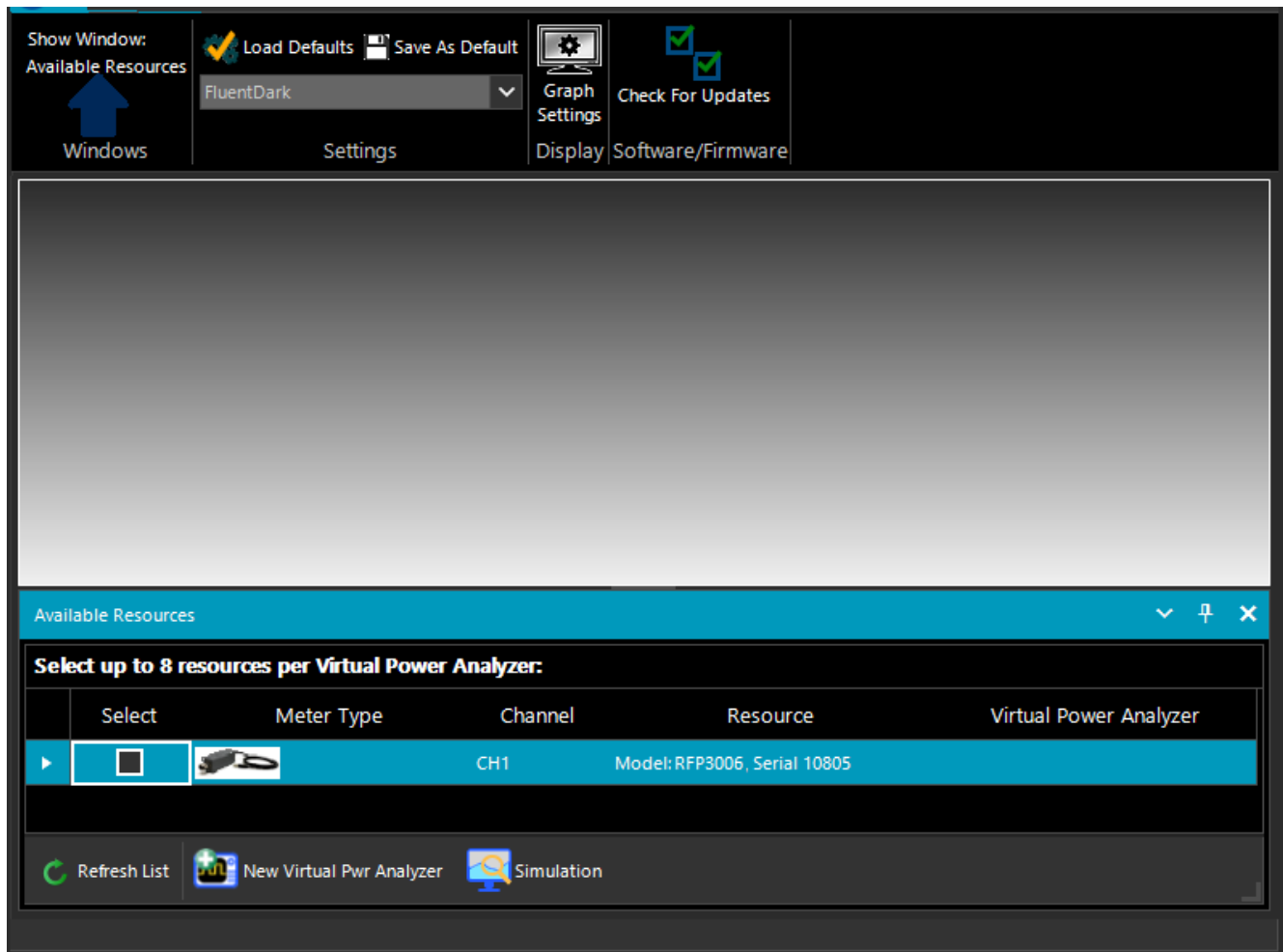

Figure 3.3 Available Resources

In the Available Resources window, check the "**Select**" box for one or more connected sensors, then click "**New Virtual Pwr Analyzer**". This will launch a new Virtual Power Analyzer instance containing trace and control windows. If an RF signal is connected to the USB sensor, the measured waveform will appear in the trace window.

A "Virtual Power Analyzer" is analogous to a benchtop RF Power Analyzer with one or more sensors connected. Time and trigger controls are typically common to all sensors within a Virtual Power Analyzer, while channel-specific controls are available for most other settings. This offers users the familiar, multi-channel approach common to power meters and oscilloscopes.

When independent control of time base-related settings is desired, it is possible to open multiple Virtual Power Analyzers, each with their own full set of controls.

3.3.1 Docking Windows

The **Power Analyzer Software** uses dockable windows to allow the user to arrange the various windows in the configuration of their choice. You can drag a docked window by clicking its title bar. This action enables you to move the window to a different docked position or undock it.

To dock tool windows

- Click the tool window to dock.
- Drag the window toward the middle of the software main window.
- A guide diamond will appear with four arrows pointing toward the four sides of the main window.
- When the tool window being dragged reaches the location to dock it, move the pointer over the corresponding portion of the guide diamond. The designated area is shaded blue.
- To dock the window in the position indicated, release the mouse button. Note that docked windows can be overlapped. By selecting individual tab, it is possible to resize each tool windows and can be repositioned as below picture.
- A tool window can be docked to a portion of one of the side walls of the software by dragging it to the side until you see a secondary guide diamond. Click one of the four arrows to dock the tool window to that portion of the side wall.

The following diagram shows the guide diamonds with arrows that appear when you drag a tool window toward the center of the BK Precision software main window. The diamond on the right edge only appears when a tool window is being dragged towards the edge of the main application window.

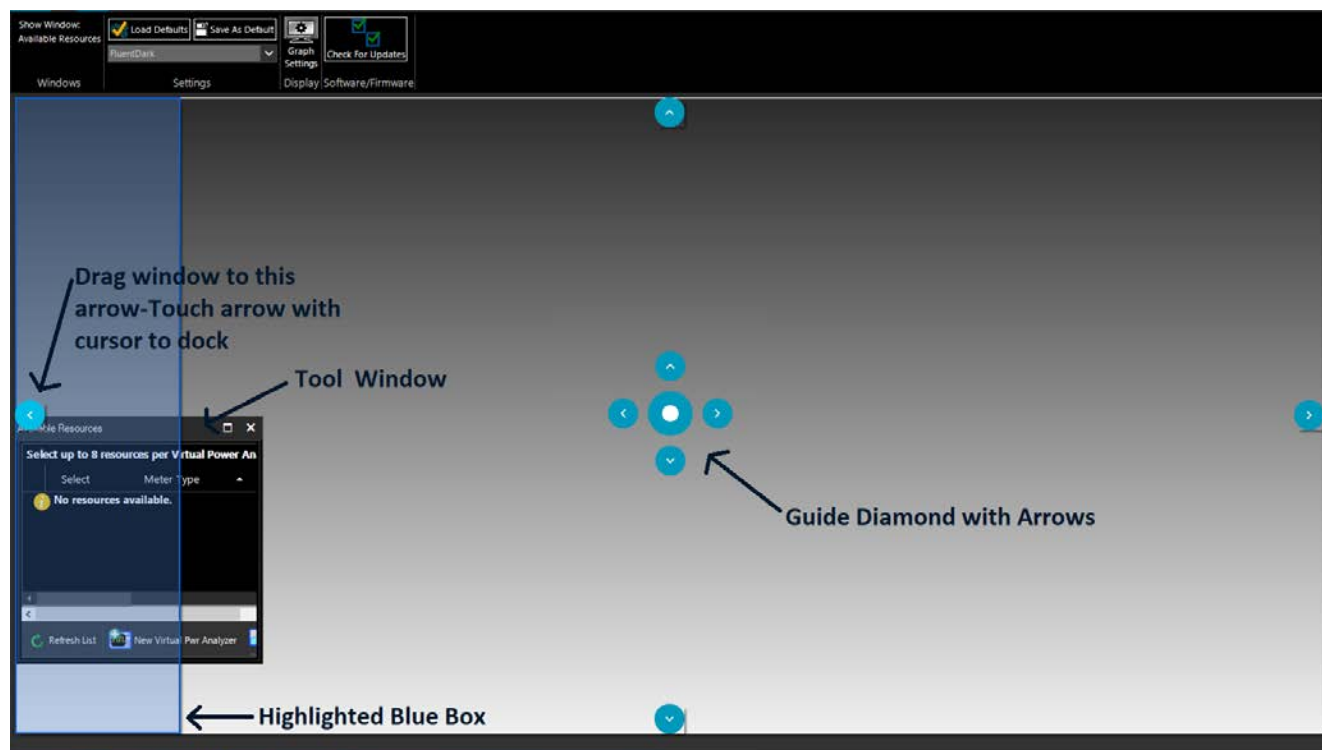

Figure 3.4 Docking a Sidebar

Note:

Each of the tool windows is highlighted as a rectangular box to be positioned by dragging in any direction within the main window. Figure 3.4 is one example, but all the tool windows can be rearranged within the main software window.

3.3.2 Main Application

The main application window is divided into several major sections and dockable windows depending on the type of measurement selection. These windows can be arranged easily by docking and undocking within the main application display area.

3.3.3 Available Resources Window

Sensors can be selected from the **"Available Resources"** window. A description for each connected resource will indicate the hardware version, model and channel information including alias. User can select up to eight resources per Virtual Power Analyzer. Following resource selection, click on **"New Virtual Pwr Analyzer"** and a new Virtual Power Analyzer instance will open with a default configuration suitable for pulse measurements.

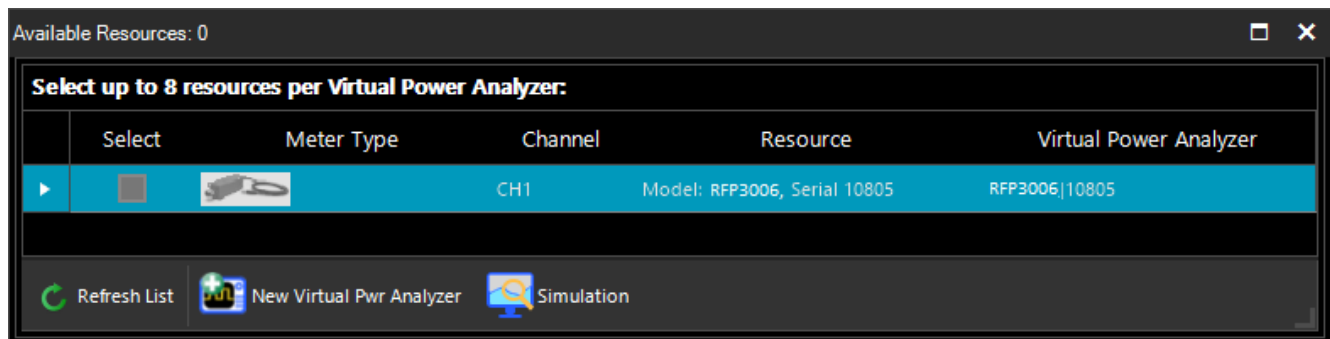

Figure 3.5 Selecting a Sensor

3.3.4 The Main Toolbox

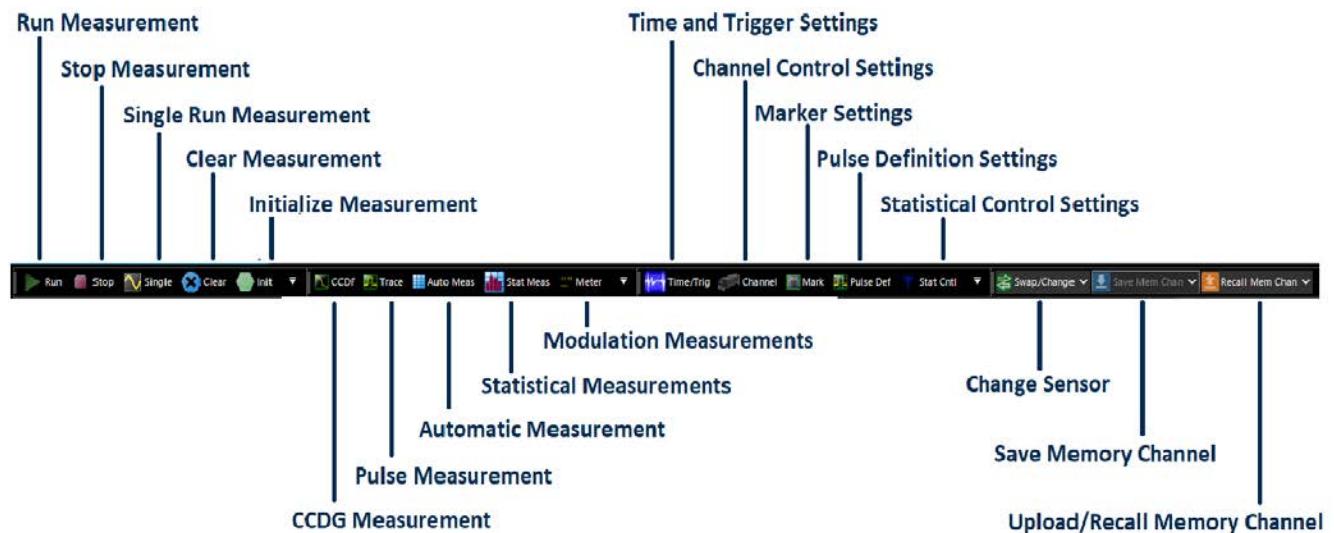

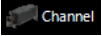
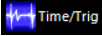

Figure 3.6 Main Toolbar Controls

3.3.5 Trace View Window

In order to display a pulse measurement, users must select the  icon from the Main Toolbar.

The  settings and  settings related to pulse measurement can be selected from Main Toolbar and can be applied to the measurement.

The **Trace** button on the **Main Toolbar** is used to setup and display a pulse measurement.



Figure 3.7 Main Toolbar

A measurement window configuration suitable for pulse measurements is shown in figure 3.8. This shows a large trace window, automatic measurements, and a tabbed control box for time and channel settings.



Figure 3.8 Main Application Window

The **Power Analyzer Software** allows the user to directly enter numeric values for most settings in the Channel Control and Time/Trigger windows. For many of the controls, additional methods such as increment/decrement or preset buttons are available.

Trace Pan and Zoom

The mouse can be used to select a zoom area to view detail in an area of interest on the displayed waveform. The highlighted dragged rectangular area indicates the minimum area that will be shown when the zoom operation completes.

Horizontal pan or zoom adjusts the time base (within preset values) and the trigger delay to highlight an area of interest without vertical rescaling.

Direct pan or zoom to waveform areas of interest is available by selecting any option from the lower toolbar of the trace window. Available options for zoom/pan control are: Horizontal & Vertical, Horizontal, Pan and None with Undo and Redo selections.

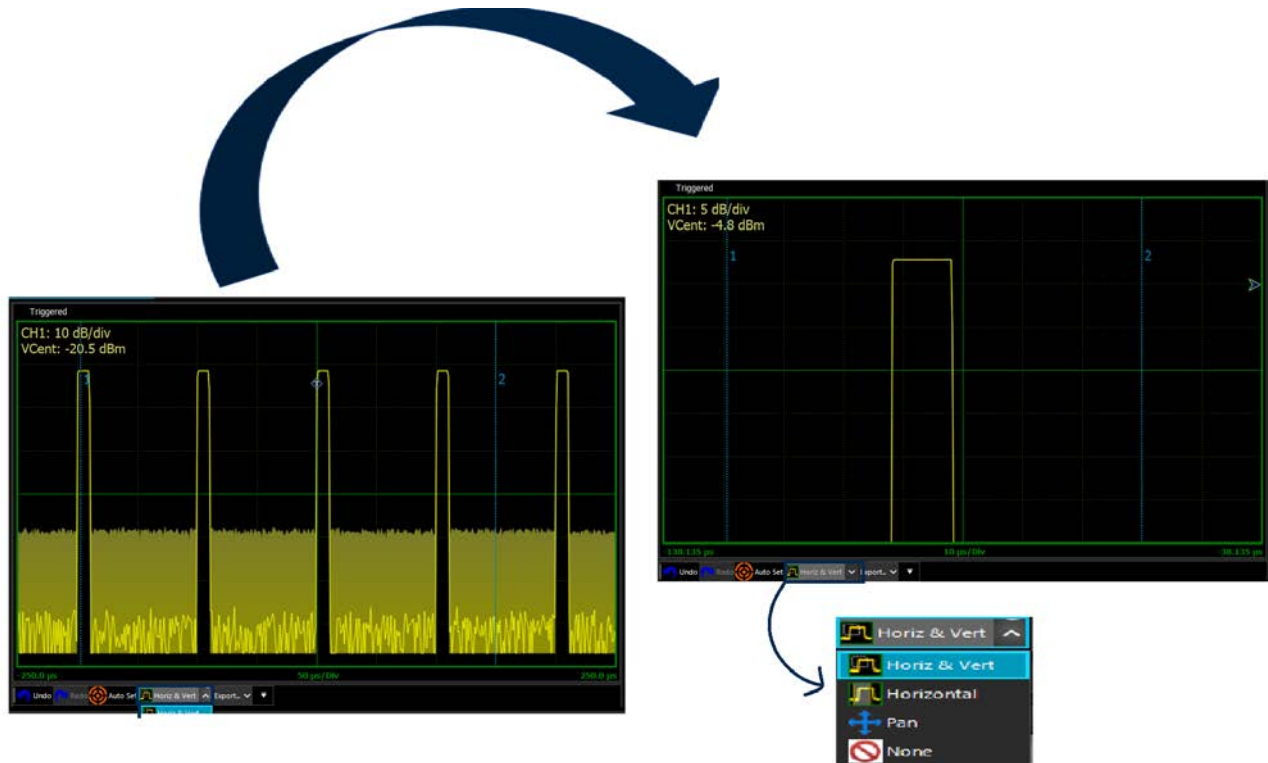



Figure 3.9 Zoom and Pan

Clicking on the Trace View display and dragging will open a zoom box, releasing the mouse button will result in the trace being expanded to show the area contained in the zoom box

Auto Set

The  button below the trace window attempts to configure level scaling, trigger level and timing for a “best fit” display based upon amplitude and timing of the applied signal. All other parameters are set back to defaults. If the Auto Set process fails, all settings are left untouched.

Trace Data Export

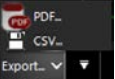
Any trace window can be exported and saved or printed as a PDF or CSV document by selecting the  button from the lower toolbar of the trace window. An exported trace file can easily be imported into a spreadsheet or other report file or documentation.

3.3.6 Channel Control Window

Select the  icon and a dockable sidebar will appear on the righthand side of the main application window by default. This allows you to change all related settings to control one or more sensor channels. Channel control setting is defined by several parameters as listed below.

Channel: Select one or all channels (for multi-channels) via the dropdown list. Selecting the "All" permits simultaneous update on all measurement channels (up to 8) for most settings.

Units: Selects dBm, Watts or Volts measurement units. Selection affects displayed text, measurements, and trace.

Vert Scale / Center: Sets vertical amplitude scaling and centering of the displayed waveform. These settings affect only the trace display.

Sensor Enabled: Enable or disable individual connected sensors.

Trace Avg: Sets number of acquired sweeps averaged together for displayed trace in pulse/triggered modes. Useful for noisy signals.

Mod Filter/Filter Mode: Sets manual or automatic filter integration time window for measurements in modulated (non-triggered) acquisition modes.

Peak Hold Mode/Decay Count: Sets peak hold duration (# of sweeps). Tracks Trace Avg setting or may be independent.

Video BW: Selects sensor video bandwidth, high or low.

Frequency: Sets measurement frequency for the applied RF signal.

Cal & Corrections: Offset compensates reading for external gain/loss.

Zeroing and Fixed Cal: Sensor zeroing and fixed calibration can be performed by selecting each specific button.

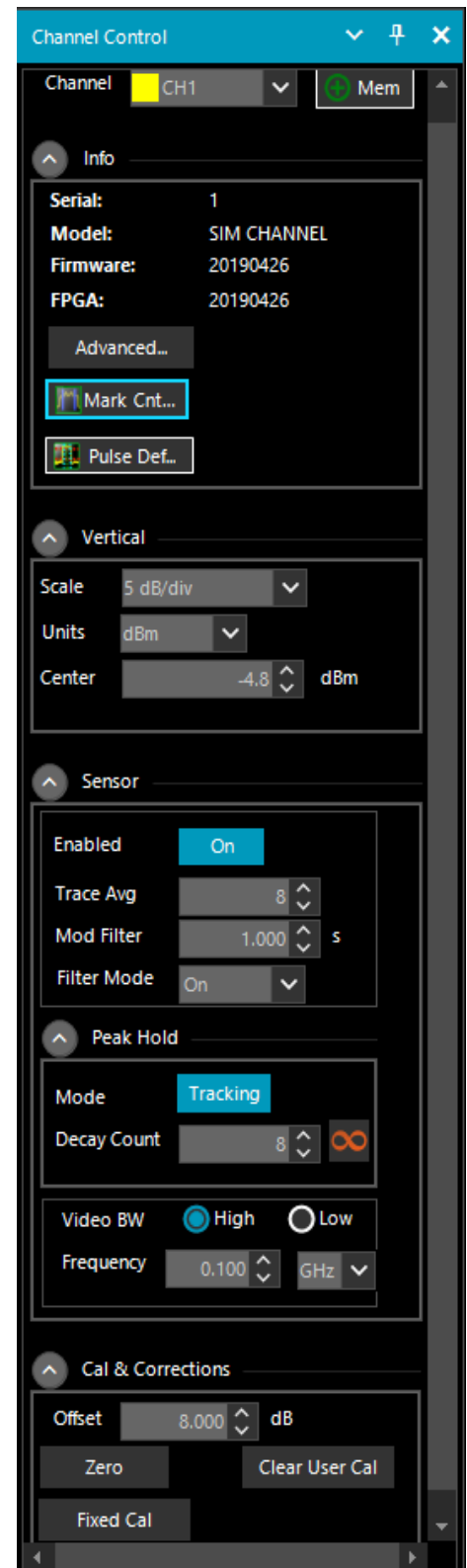

Figure 3.10 Channel Control Menu

3.3.7 Time/Trigger Settings Window

Select the  icon to customize all related settings for both time base and trigger of a pulse signal.

Time base: Acquisition time in seconds per division. The power sensors use a fixed grid of 10 divisions for the sweep extents. Settings are in a 1- 2-5 sequence. Consult series specifications for time base range.

Trigger Delay: Trigger delay can be adjusted by manually entering a numerical value into the field or using the up-down arrow keys. Click the "0" icon to reset the trigger delay to zero seconds (RTP5000 only).

Trigger Position: Trigger position can be changed by entering numerical values into the "Divisions" field, clicking the scroll arrows, dragging the slide control, or by clicking the L/M/R (Left/Middle/Right) indicators.

Trigger Source: Several trigger modes are available for each trigger source under "Trigger Control" section. Multiple trigger sources are available under the drop-down list including both "Internal" and "External" selection.

Trigger Mode: Select Normal, Auto, Auto Level or Free run. **Trigger Level:** Sets trigger level when trigger source is INT and trigger mode is Auto or Normal.

Slope: Select rising or falling edge triggering.

Holdoff: Sets trigger holdoff time and selects between Normal or Gap holdoff mode.

Trigger Skew Adjustment: This feature allows the user to adjust the skew for internal trigger with master trigger output, and also external and slave triggers. Skew adjustments allow to calibrate out trigger delay between sensors so the user can measure propagation delay of the DUT from input to output. Manual skew adjustments can be made by entering the skew value in the numeric entry field. The button to the right of each skew adjustment is the Auto-Skew button which is described in detail in section "[Time/Trigger Control Window](#)". This feature allows automatic adjustment of the skew.

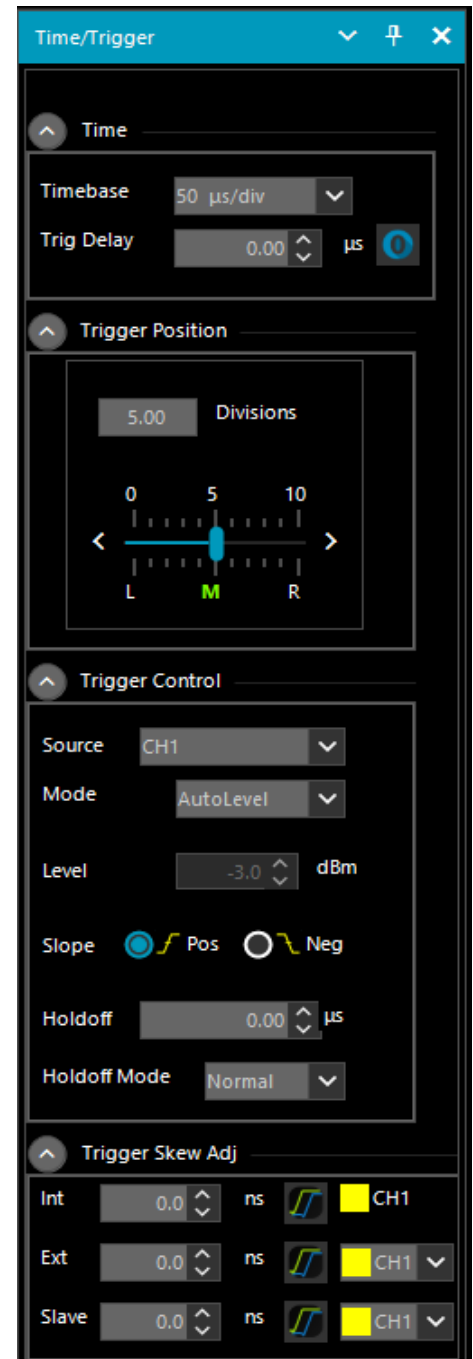



Figure 3.11 Time/Trigger Menu

3.3.8 Marker Settings Window

Programmable markers can be moved to any portion of the trace that is visible on the screen. They can be used to mark regions of interest for detailed power analysis. The instrument can display power at each marker, as well as average, minimum, and maximum power in the region between the two markers.

Click the  icon to control the settings for time markers and amplitude reference lines of a pulse signal.

Markers: Time Marker position settings will allow you to change both marker 1 and marker 2 time positions by using either arrow keys or entering numerical values into the field. It will also display the time delta value between the two markers.

Reference Lines: Also known as Horizontal Markers, can be enabled by selecting On/Off button for each individual channel. Once enabled, users may select several options for automatic amplitude tracking from the Tracking drop down list: Off, Markers, TopBottom, DistalMesial and DistalProximal. Two reference lines can be set by using up/down arrow keys. Horizontal markers are useful to determine the difference with regard to loss.

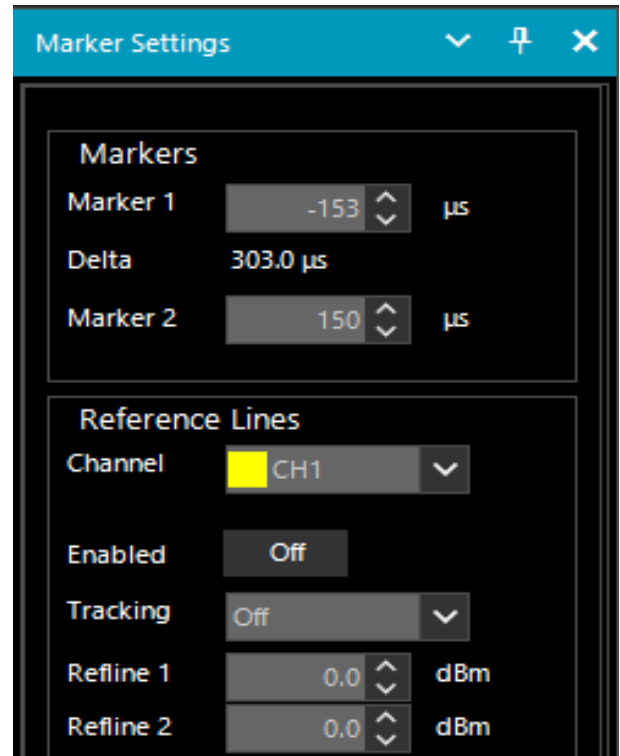



Figure 3.12 Marker Settings Menu

3.3.9 Pulse Definitions Windows

Click the  icon to control the settings of the pulse thresholds and the pulse gate.

Pulse Thresholds: Pulse definition setting allows user to define distal, mesial and proximal values for pulse thresholds. It is also possible to change pulse unit from watts to volts.

Pulse Gate: Pulse start and end gate can be changed both numerically and by changing up/down arrow keys.

Chapter 6 contains a detailed description of each pulse threshold level and the pulse measurement process.

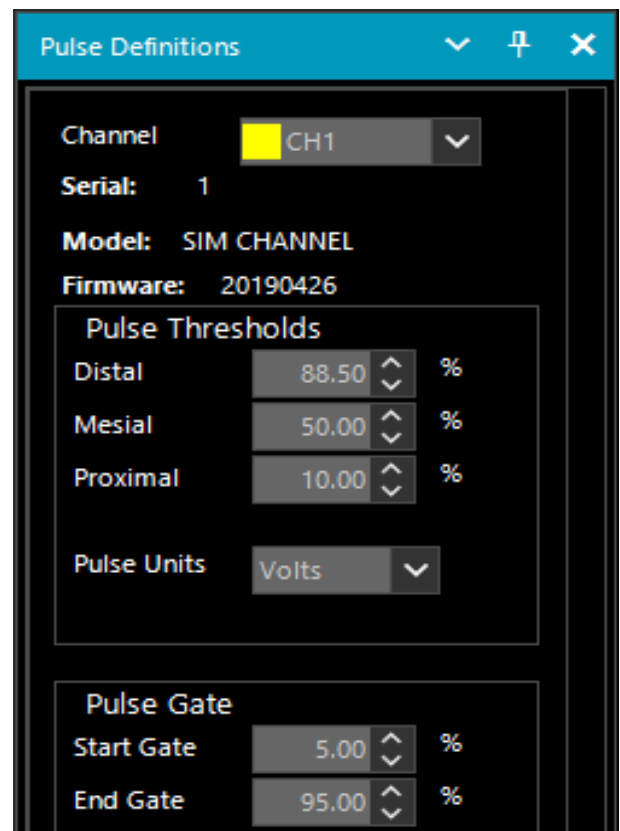
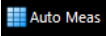

Figure 3.13 Pulse Definition Menu

3.3.10 Automatic Measurements Windows

Select the  icon to display a tabulated field with a list of parameters for RF pulse measurements including marker measurements. Below is an example screenshot for automatic parameters displayed for a typical pulse measurement.

Note:

All field parameters are customizable, and can be edited or deleted from the list. The whole table can be copied and pasted into a spreadsheet in order to make any custom report file along with captured screenshots by selecting export button as provided by the software.

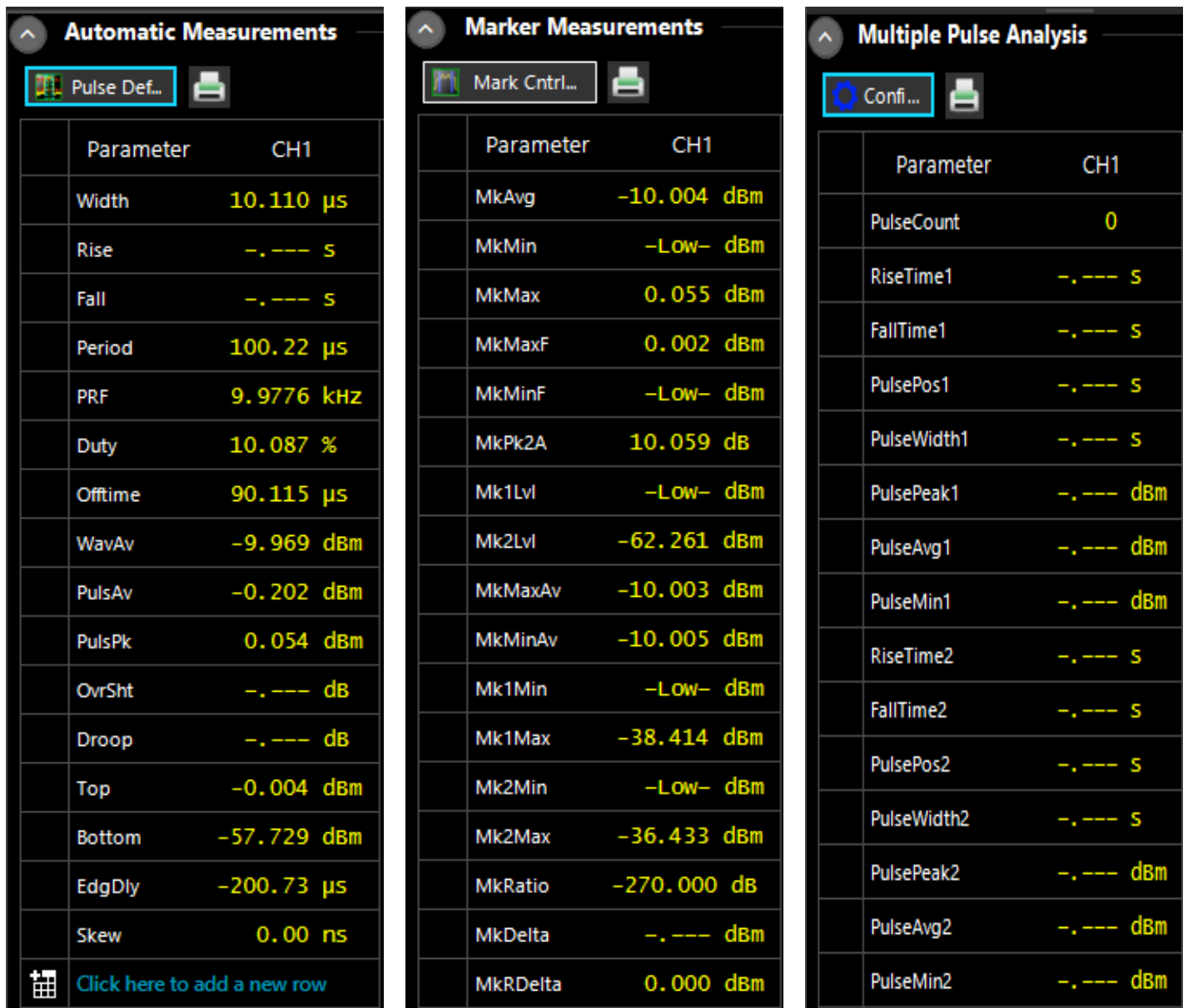

Automatic Pulse Measurements

Automatic Marker Measurements

Multiple Pulse Analysis

Figure 3.14 Auto Measurement

Customize Field Parameters

All field parameters under automatic measurement are customizable, and can be edited or deleted from the list by selecting individual parameter fields and then by using **right click** button of the mouse.

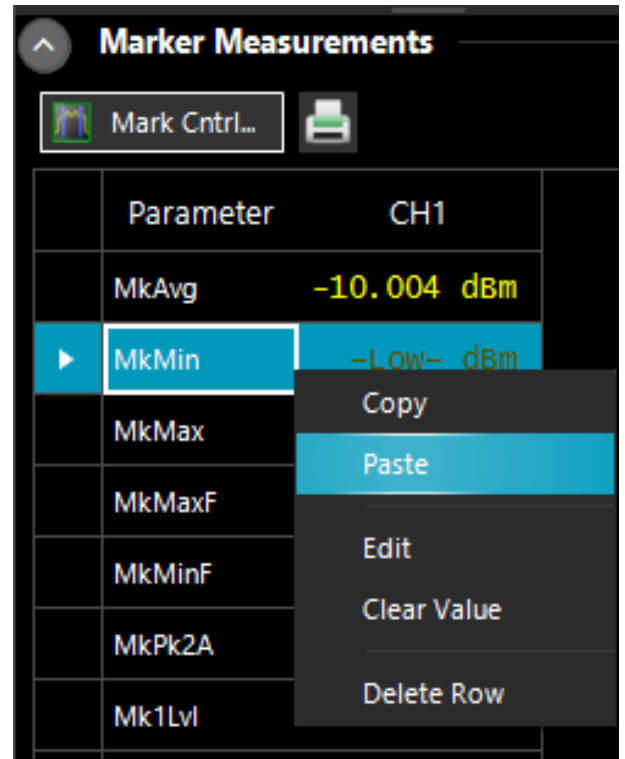

Figure 3.15 Pulse Measurements Customize

Export or Copy Field Parameters

The whole automatic table or individual parameter field can be copied and then pasted into a simple spreadsheet or document in order to make a custom report file along with captured screenshots provided by the application.

To select multiple parameters **right click** using the mouse while holding the **Ctrl** key.

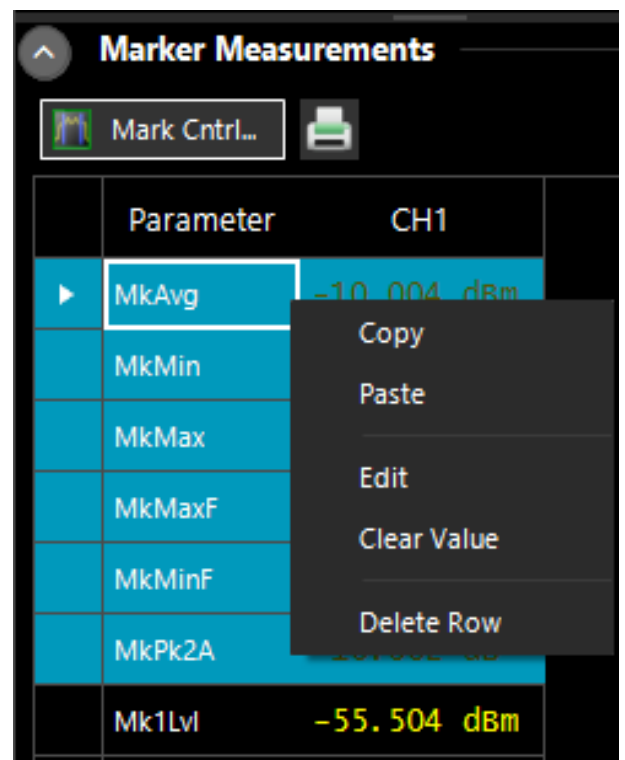

Figure 3.16 Select Multiple parameters

3.3.11 Display Settings Windows

The display settings allow for customization of data and trace colors for each measurement channel, and enable or disable trace display features such as Average, Envelope, Maximum, Minimum and Persistence. It is also possible to adjust marker color, background, grid colors and more under "Graph Colors" section of the display settings.

To open the Display Settings Windows left click on the **Graph Settings** icon located in the **View** tab.

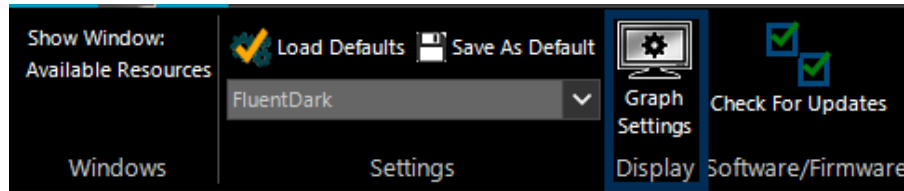

Figure 3.17 Graph Settings

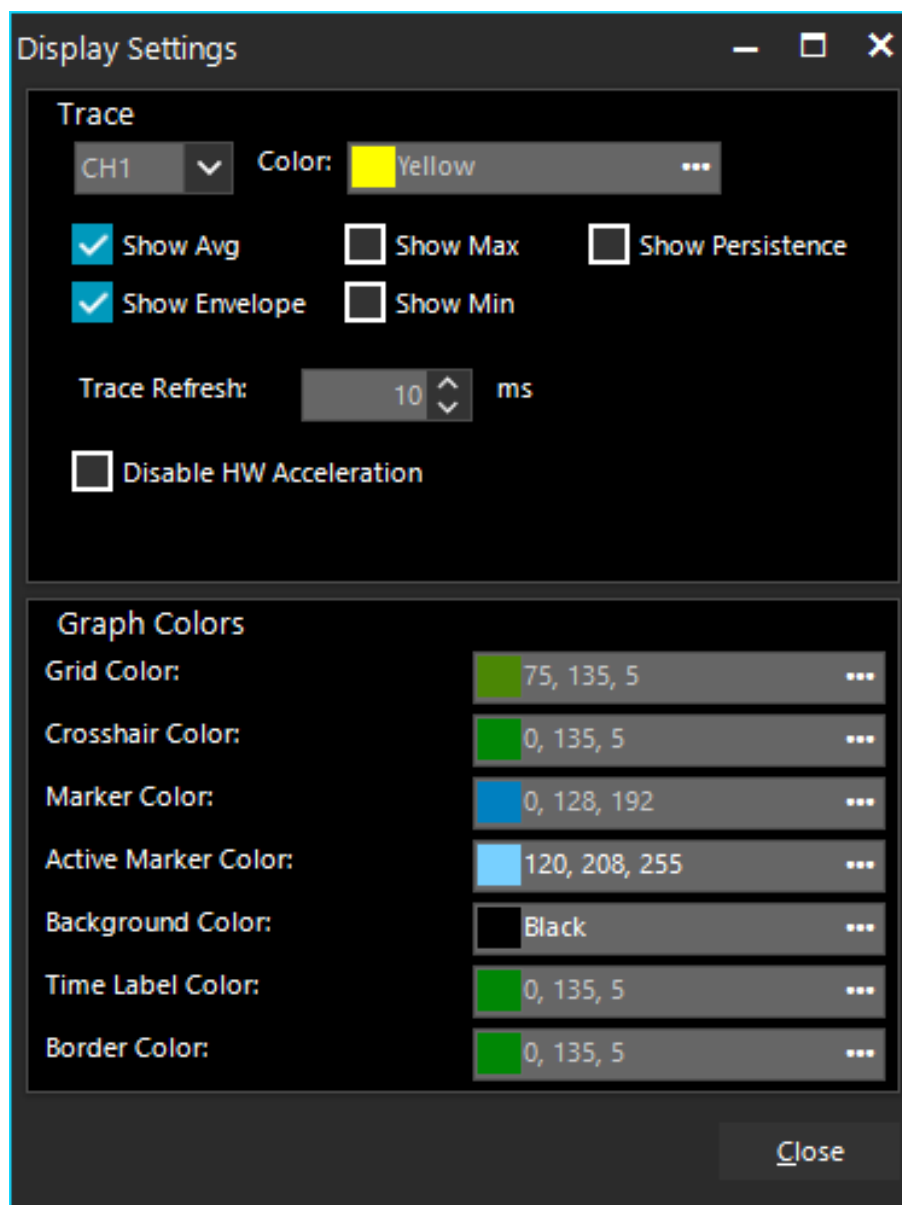

Figure 3.18 Display Settings

3.3.12 CCDF View Window



For statistical measurements, select the  icon from menu bar to view a CCDF graph. The sidebar on the CCDF screen allows adjustment of horizontal scale, horizontal offset, cursor type, cursor position and dB offset. The user can also enable/disable capture or reset the statistical data acquisition.



Figure 3.19 Complementary Cumulative Distribution Function Graph

3.3.13 Statistical Measurements Window

Select the  icon, to tabulate a list of statistical measurements. An example can be seen in figure 3.20

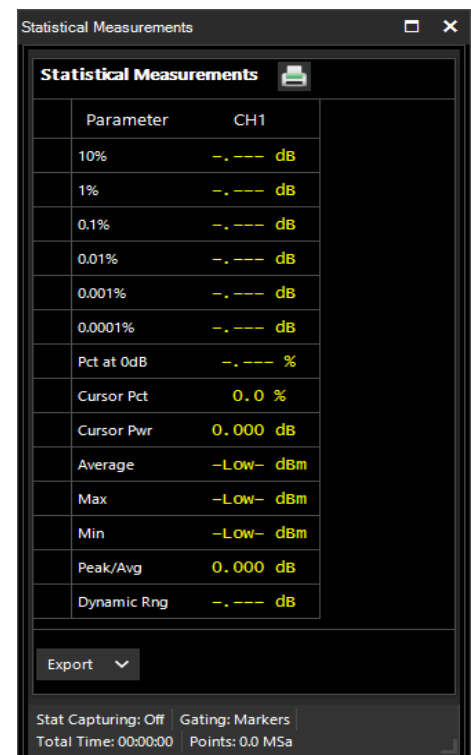

Figure 3.20 Statistical Measurements Window

Operation

This section presents the procedures for operating the RFP Sensors using the **Power Analyzer Software**. All the display windows that control the sensor are illustrated and accompanied by instructions for using each in the window.

4.1 Power Analyzer Software

The **Power Analyzer Software** is a Windows-based software program that provides immediate RF power measurements from RFP Sensors without the need for programming on your Windows OS based computer. The measurements parameters from the power sensor can be displayed on your computer or can be integrated into a test system using an Application Program Interface (API).

Note:

This section of the manual assumes that the **Power Analyzer Software** has been installed on a computer using the instructions provided in the "Getting Started" chapter of this manual.

4.1.1 Initializing the Software

Use a mouse or other pointing device to click on the View tab on the top of the window.

Click on Load Defaults – this will load the default Windows Theme ‘Visual Studio 2012 Dark’ and will reset all application measurement settings to default values provide a known initial state.

Click on the down arrow adjacent to the theme to view the pull-down menu showing the available themes. The themes establish the look of the Windows environment setting colors, fonts, and backgrounds.

The balance of this chapter will use the ‘Default’ theme.

Click on any of the available themes to see what they look like. Select the theme you wish to use.

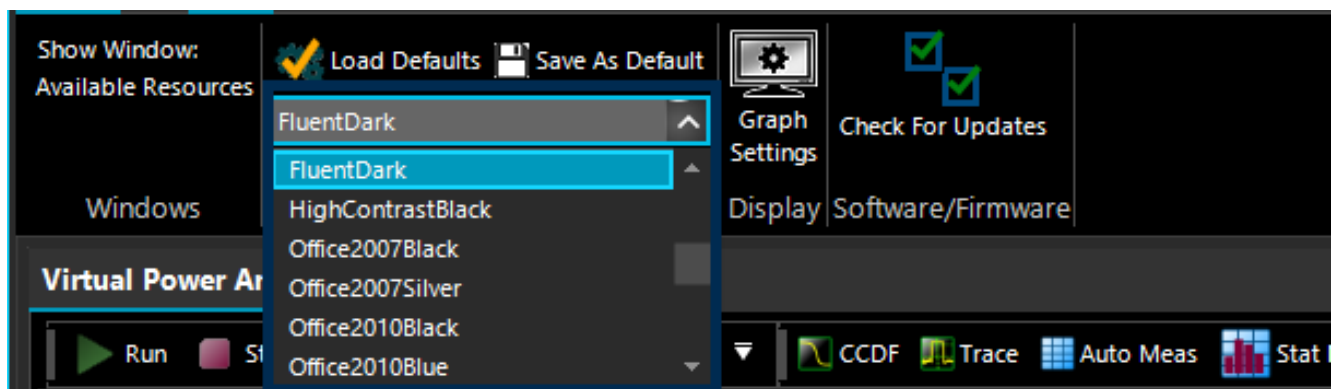

Figure 4.1 Selecting Theme

4.1.2 Connecting the RFP Series Sensor

Connect the RFP Sensor to one of the USB ports of a computer using the supplied USB cable.

Connect power sensor to RF Source using the standard Type N connection port on the sensor.

Note:



- Do not turn the body of the sensor when connecting the sensor to a unit under test (UUT). To avoid internal sensor damage, connect and disconnect the sensor by turning the metal nut of the N connector only until it is 'hand tight'.
- Ensure that you do not apply any excessive force on the sensor once it has been connected.
- Do not exceed the specified RF power at the RF input of the sensor.

Once the power sensor is connected, a pop up box will appear in the **Power Analyzer Software** as in figure 4.2 with the list of connected devices name and hardware information.

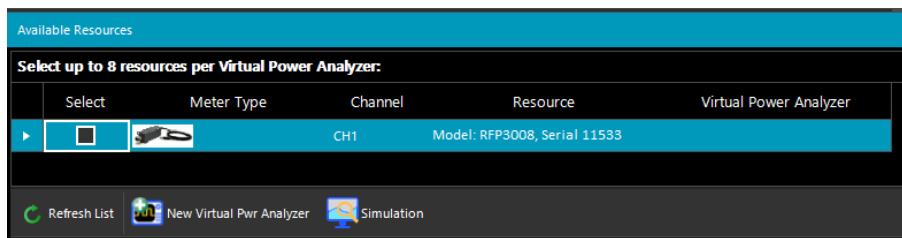

Figure 4.2 Available Resources Window

Up to eight sensors can be connected to the software. Click on the "Select" box of one of the sensors, click the "New Virtual Pwr Analyzer" button at the bottom, a new **Virtual Power Analyzer** window will show up. If you have an RF signal connected already to the power sensor, the measured signal should display in the **Trace View** window which appears along with the Channel Control tool window as shown in figure 4.3.



Figure 4.3 Trace View

4.1.3 Trace View Display

The Trace View window in figure 4.3 displays a trace of power versus time. The readout in the upper left corner shows the channel number of the trace, the vertical scale factor and the vertical center. In figure 4.3 Channel 1 is displayed with a vertical scale of 10 dB/div(ision) and a vertical center of -3.5 dBm.

The horizontal scale of the trace in the Trace View window is shown at the bottom of the grid. At the center of the horizontal axis is the horizontal scale factor. Numbers at the right and left ends of the horizontal axis show the trace start and end times relative to the trigger.

The two vertical blue lines labeled 1 and 2 are markers used for measurements of the displayed signals. These will be discussed later in the manual.

Trace View Toolbox

The bar at the bottom of the Trace View window provides a number of useful tools that can be used to optimize the trace display and archive the trace(s):

- The **Export** menu box is used to export any trace window as a PDF or CSV document. These exported trace files can be used for a report or document.
- The **Undo** and **Redo** buttons work in conjunction with the display expansion (zoom) function to remove (Undo) and restore (Redo) changes in display scaling.
- **Auto Set** provides an automatic setup of the trace display scaling which optimizes the trace view in the Trace View window.
- The **Cursor Mode** menu box is used to select the zoom mode.
 - **Horiz(zontal) & Vert(ical)** lets the graphical drag and drop zoom control both horizontal and vertical expansion.
 - **Horizontal** limits the zoom controls to affecting the horizontal scaling only
 - **Pan** allows the user to click and drag the trace either horizontally or vertically.
 - **None** turns off both zoom and panning.
- The pull-down menu box is used to customize the **Trace View** toolbox.
 - **Add or Remove Buttons** sets the tools to be displayed in the toolbox.
 - **Customize** sets the order of the tools displayed in the toolbox.

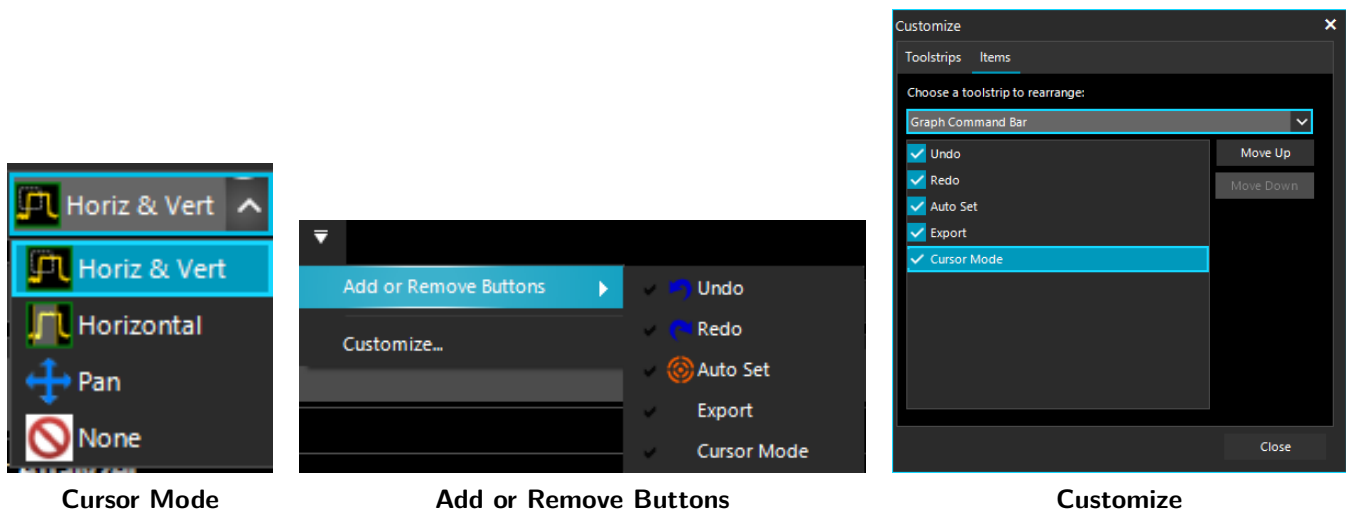

Figure 4.4 Trace View Toolbox Pull Down Menus

Trace Pan and Zoom

The application has a trace zoom feature which lets a user to drag a rectangular box (like the one shown in figure 4.5) around the trace in order to zoom onto a special area of the displayed waveform.

The highlighted dragged rectangular area indicates the minimum area that will be shown when the zoom operation completes. The zoom area is constrained to the preset Time base settings and trigger Vernier limits.

Note that in figure 4.5 that the zoom horizontal scale changes from 10 $\mu\text{s}/\text{div}$ to 50 ns/div the nearest available fixed Time base setting. Vertical scaling is similarly constrained.

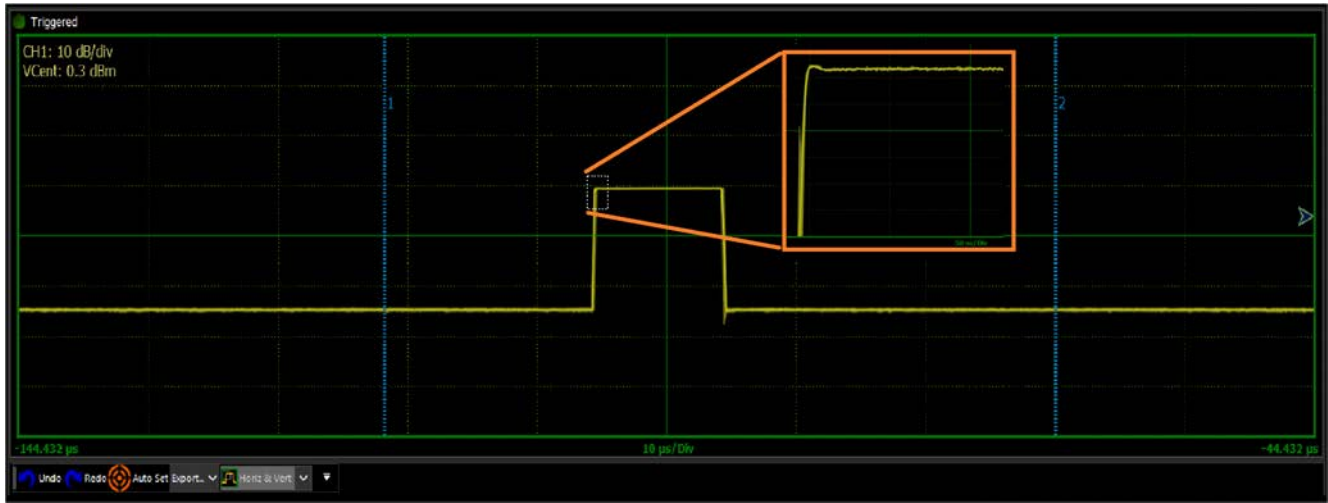

Figure 4.5 Horizontal and Vertical Display Expansion

Note:

Horizontal or horizontal and vertical display expansion (zoom) is accomplished by clicking on the trace view and dragging the mouse diagonally while holding the mouse button down. A box will outline the area to be expanded. Releasing the mouse button will rescale the trace.

4.1.4 Formatting Trace View Display

To open the **Display Settings Windows** left click on the **Graph Settings** icon located in the **View** tab.

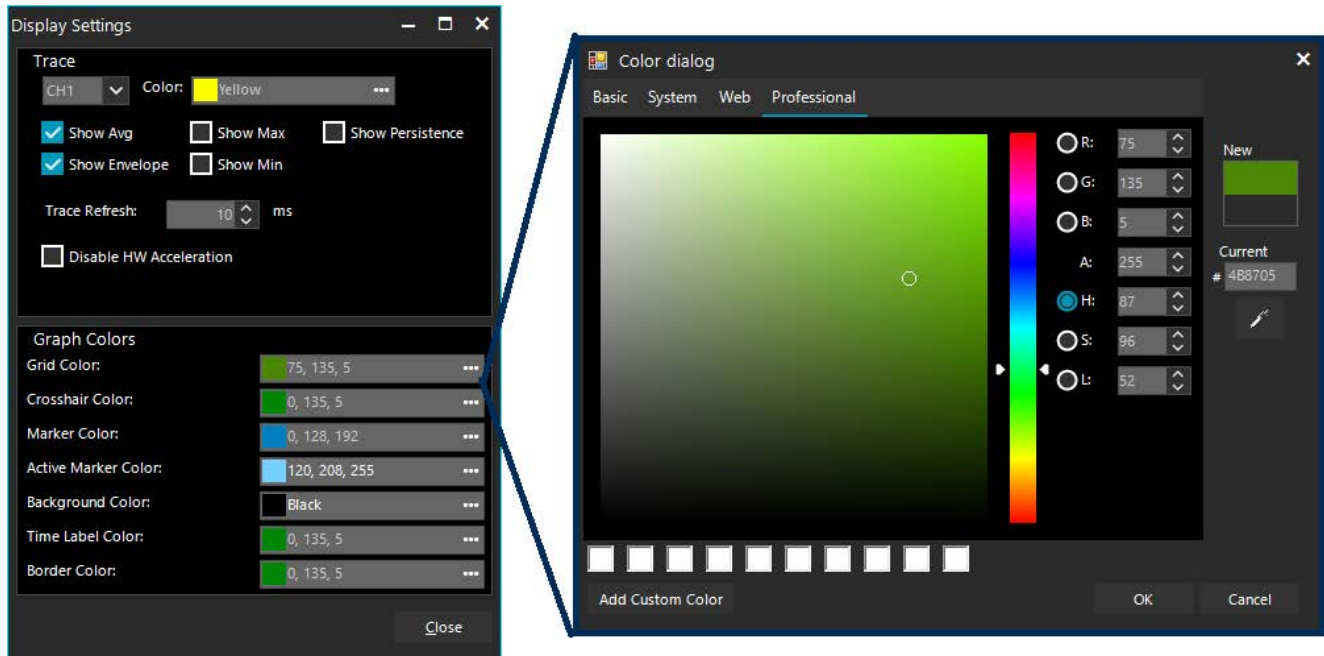

Figure 4.6 Display Settings

The Display Settings pop-up is used to configure the Graph View. The elements to be displayed can be chosen and their colors may be selected along with the background color.

The upper section of the Display Settings labeled Trace controls the configuration of the selected trace. There can be a maximum of eight traces. The configuration of each trace includes the trace color, the choice of five viewable trace attributes, and the trace refresh time. Trace attributes include graphical view of the average value, envelope, maxima, minima, and persistence (trace history). The defaults are to Show Avg and Show Envelope. Each of the selected elements is overlaid on the trace.

Note:

The sensor acquires all three "traces" (average, min and max) when required. These are used for several of the marker measurements such as interval peak-to-average, and others.

For the marker intervals, Min and Max (highest maximum trace and lowest minimum trace points) as well as MinF and MaxF (min and max filtered) which are the highest and lowest points on the average trace.

The former measurements are useful for looking at modulation, while the latter are most useful for seeing systematic peaks and dips (for example, ringing) of a repetitive waveform with the noise reduced.

A check box for Disable HW Acceleration can be checked if the computer does not have a monitor or graphics card or if it is being operated remotely using remote desktop. Note: This change will not take effect until the next time a trace window is opened.

The lower section of the Display Settings pop-up provides controls for color choices for trace grid, border, and background. Markers, axis label, crosshair color selections are also included. Color choices are made by clicking on the ellipsis symbol (...) adjacent to each element. This will bring up the Color Dialog palette used to set the desired color for the element.

4.1.5 Main Toolbar

The **Power Analyzer Software** always displays the Main Toolbar that is located at the top of the main program window and contains shortcuts to commonly used functions and measurements.

The **Main Toolbar** can be customized as discussed below. Figure 4.7 shows the Main Toolbar:



Figure 4.7 Main Toolbar

The Main Toolbar contains three sections called Toolstrips. The group of shortcuts on the left, including **CCDF**, **Trace**, **Auto Meas**(urement) and **Stat**(istical) **Meas**(urement) are the Measurement Windows Toolstrip and will bring up trace display or measurement windows. The middle group with **Time/Trig**, **Channel**, **Mark**, **Pulse Def**(initions) and **Stat**(istical) **Cntl**(Control) are the Control Windows Toolstrip, and will cause setup and control windows to be displayed. The final group including **Run**, **Stop**, **Single**, **Clear** and **Init**(ialize) are the Acquisition Control Toolstrip and affect the state of the acquisition.

Any of the toolstrips may be separated from the Main Toolbar and re-positioned by clicking on the ellipsis symbol at the left end of any of the groups and dragging the toolstrip.

The drop-down menu bar on the right of each section allows the user to edit the tools bar by adding or removing any of the items under the Items tab. The Toolstrips tab allows the user to show or hide the tools strips.

Acquisition Control Toolstrip

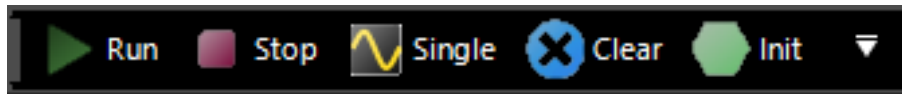

Figure 4.8 Acquisition Control Toolstrip

The buttons on this toolstrip control the state of the acquisition:

- **Run** – Starts the measurement acquisition and allows it to run continuously until stopped.
- **Stop** – Stops the measurement acquisition.
- **Single** – Starts a single measurement acquisition and then stops.
- **Clear** – Erases the acquired data trace. Useful in clearing a single or averaged acquisition.
- **Init** – Initializes or resets all settings for the active Virtual Power Meter to default values.

Measurement Control Toolstrip



Figure 4.9 Measurement Control Toolstrip

The buttons on this toolstrip create **Trace View** and **CCDF Graph** displays as well as the automated power measurement and statistical Measurement tabular display windows:

- **CCDF** – This button turns on the complementary cumulative distribution function (CCDF) display. If the CCDF display is already opened but hidden behind the Trace View display this button will bring the CCDF trace to the foreground.
- **Trace** - This button turns on the Trace View trace that displays power versus time.
- **Auto Meas** – This button opens Automatic Measurement windows showing the automatic Pulse and Marker Measurements tables.
- **Stat Meas** – This button opens the Statistical Measurements window displaying the measurements associated with the CCDF Graph.

Control Windows Toolstrip



Figure 4.10 Control Windows Toolstrip

The buttons on this toolstrip control the setup windows for the acquisition, and measurement functions.

- **Time/Trig** – This button displays the Trigger and Time base control windows.
- **Channel** – This button brings up the Channel Control Window allowing control of the vertical range and offset as well as sensor related settings
- **Mark** – This button causes the Marker Settings window to be displayed. Marker and reference lines can be controlled from here.
- **Pulse Def** – This button displays the Pulse Definitions window controlling the pulse measurement thresholds, units, and gating.
- **Stat Cntl** – This button brings up the Stat(istics) Mode Control window with scaling and population control for the CCDF display.

Memory Channel Toolstrip

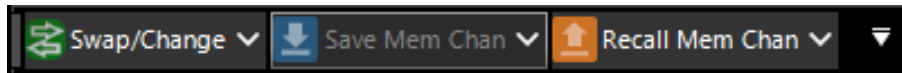

Figure 4.11 Memory Channel Toolstrip

The Memory Channel toolstrip contains Swap/Change, Save Mem(ory) Chan(nel), and Upload Mem(ory) Chan(nel), and controls the sensor connection source and saving and recalling Mem(ory) traces. The Memory Channel is a reference trace that appears on the Trace View when Mem+ is enabled.

- **Swap/Change** - Swap/change allows you to change sensors for a particular session if more than one is connected.
- **Save Mem(ory) Chan(nel)** – Saves the current Memory channel to a user selected folder on the computer.
- **Upload Mem(ory) Chan(nel)** – recalls a stored Memory Channel to the Memory Channel Trace on the Trace View.

4.1.6 Time/Trigger Control Window

Pressing the Time/Trig button icon the Control Windows toolbar will bring up the Time base / Trigger Control window shown in figure 4.12

This window has four sections **Time**(base), **Trigger Position**, **Trigger Control**, and **Trigger Skew Adj**(ust). Any of these sections can be opened or collapsed by clicking on the up/down arrow buttons to the left of the section titles.

Time and Trigger Position Controls

Settings in the Time and Trigger Position Control groups affect horizontal scaling and position of the acquired waveform.

Time base controls the Time base or horizontal scale of the acquisition and is noted on the horizontal axis label of the Trace View. The Time base pull-down menu permits selection of fixed Time base ranges from 5 ns/div to 50 ms/div (sensor series dependent) in a 1-2-5 progression.

Trig(ger) Delay can be adjusted either manually entering a numerical value into the field or using the up-down arrow keys.

The trigger delay time is set in seconds with respect to the trigger. Positive values mean that the trace display shows a time interval after the trigger event. This positions the trigger event to the left of the trigger point on the display, and is useful for viewing events during a pulse, or some fixed delay time after the rising edge trigger. Negative trigger delay mean that the trace display shows a time interval before the trigger event, and is useful for looking at events preceding the trigger edge.

Pressing the '0' button to the right of the trigger delay entry field resets the trigger delay to zero.

The range of trigger delay times is dependent on the Time base setting and is summarized in table 4.1. Note the range will also depend upon the trigger position.

Time base Setting	Trigger Delay Range
5 ns/div to 10 us/div	-1.26 ms to 100 ms
20 us/div	-1.26 ms to 200 ms
50 us/ div	-5.04 ms to 200 ms
100 us/ div	-6.3 ms to 500 ms
200 us/div	-12.6 ms to 1
500 us/div	-31.5 ms to 1 s
1 ms/div	-63 ms to 1 s
2 ms/div to 10 ms/div	-126 ms to 1 s
20 ms/div	-252 ms to 1 s
50 ms/div	-628 ms to 1 s

Table 4.1 Trigger Delay Range

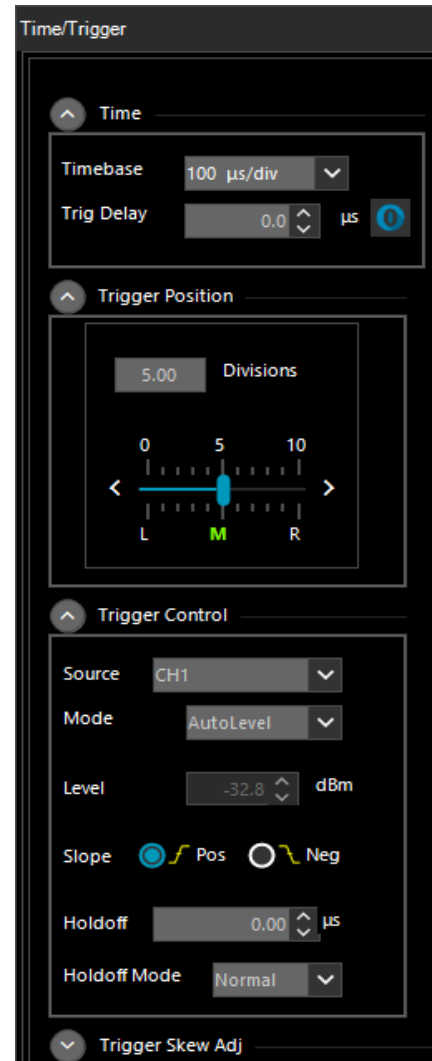

Figure 4.12
Time/Trig Control Window

Note:

Trigger delay ranges in table 4.1 are for the trigger position set to 0 divisions (Left). If trigger delay and position settings result in a pre-trigger capture interval greater than 1.26 ms, the sensor will automatically reduce the sample rate to avoid overflowing its pre-trigger memory.

Trigger Position controls are used to set the location of the trigger point on the acquired trace waveform. It can be changed by entering numerical values into the Divisions field from -30 to +30 divisions, by positioning the horizontal slider bar, or by clicking on the **L**, **M** or **R** indicators to select one of three default positions: Left (zero divisions), Middle (five divisions) or Right (ten divisions).

Trigger Controls

Settings in the Trigger Control group provides control to affect the trigger source, mode, trigger level, slope, and trigger holdoff.

Trigger Source

The trigger source can be any of the resource channels (CH1, CH2, etc.), or the Ext(ernal) trigger input signal. The Ind(ependent) trigger setting allows each connected sensor to trigger independently from its own RF input.

The external trigger is attached to the RTP Series Real-Time Power Sensors via the Multi-I/O connector adjacent to the USB port on the RTP Series Real-Time Power Sensors. The connector is an SMB type. The external trigger requires a TTL signal level, minimum pulse width of 10 ns, and maximum frequency of 50 MHz.

In a multichannel set-up, the sensors can be triggered independently as described above or in a master/slave configuration. In master/slave configuration, one channel (CH1, CH2, etc.) is selected as the source (master) and the remaining sensors automatically operate in slave mode. See [Multichannel Operation](#) for additional information.

Trigger Mode

There are four available trigger modes: Normal, Auto, Autolevel, and Freerun.

- **Normal** – The unit triggers when the amplitude of selected trigger source transitions above the preset trigger level when positive trigger slope is selected or if it transitions below the preset trigger level when negative trigger slope is selected. No automatic trigger actions takes place.
- **Auto**- Auto trigger mode operates in much the same way as Normal trigger mode, but will automatically generate a trace if no trigger edges are detected for a period of time. If a triggerable signal edge occurs during auto-trigger operation, the trigger system will resynchronize with the signal. For trigger rates below approximately 10 Hz, the Auto trigger time delay may interfere with resynchronization. Use Normal mode if this occurs.
- **AutoLevel** - performs the same function as Auto and, in addition, automatically sets the trigger level based on the peak-to-peak amplitude of the signal. For many signals this will provide a fully automatic trigger system. For slow rate signals and complex level patterns, it may not produce the desired display. Use Normal mode if this occurs.
- **Freerun** - Free Run generates horizontal sweeps asynchronously, without regard to trigger conditions. This mode is useful for locating low duty-cycle events visually.

Trigger Level

Sets the threshold level for the trigger signal in the Auto and Normal trigger modes. The trigger level can be entered numerically or changed by using arrow keys. The trigger level range has a maximum value of 20 dBm and a minimum range that is sensor model dependent (see the sensor specifications for your specific sensor model)

The trigger range is automatically adjusted to include the dB Offset parameter selected in the Cal & Corrections section of the Channel Control window. For example, if the trigger level = 10 dBm and the dB Offset is changed from 0 to 20 dB, then the offset-adjusted trigger level will be displayed to the user as 30 dBm. Likewise, the maximum trigger level range will be extended to 40 dBm. The trigger level set point and setting range are both shifted upward by 20 dB.

Trigger Slope

Sets the trigger slope or polarity. When set to Pos(itive), trigger events will be generated when a signal's rising edge crosses the trigger level threshold. When Neg(ative) is selected, trigger events are generated when the falling edge of the pulse crosses the threshold. Trigger slope can be selected by using Pos and Neg button boxes under slope.

Holdoff (Time)

The holdoff time can be entered and adjusted numerically to 0.01 μ s resolution, or using the up and down arrow keys in 1 μ s increments. The effect of Holdoff time depends on the Holdoff Mode. Set the trigger holdoff time in microseconds.

Holdoff Mode

There are two trigger holdoff modes: Normal and Gap.

Normal Holdoff

Normal trigger holdoff is used to disable the trigger for a specified amount of time after each trigger event. The holdoff time starts immediately after each valid trigger edge, and will not permit any new triggers until the time has expired. When the holdoff time is up, the trigger re-arms, and the next valid trigger event (edge) will cause a new sweep. This feature is used to help synchronize the RTP Series Real-Time Power Sensors with burst waveforms such as a TDMA or GSM frame. For periodic burst signals, the trigger holdoff time should be set slightly shorter than the burst or frame repetition interval.

Gap Holdoff

Gap or frame holdoff is very useful for packet-based communication signals where the transmission burst contains deep modulation which may fall briefly below the trigger threshold, or when bursts or pulses are of varying length and spacing, making normal holdoff ineffective. In most cases, the "off" time between transmission bursts, or frames, is considerably longer than the instantaneous modulation dips.

In gap holdoff the trigger is not armed until the trigger source remains inactive (below the trigger threshold for positive trigger slope, or vice versa for negative slope) for at least the set duration. If trigger polarity is positive, and gap holdoff is set for 1 μ s, then the signal must stay below the trigger level for at least 1 μ s before the trigger is armed. Then, the next rising edge following a gap of 1 μ s or longer will trigger the acquisition.

Trigger Skew Adj(ust)

Trigger Skew aligns the edge crossing with the trigger point for each of the trigger sources. This is done internally by adding a trim value to the trigger delay setting. Since the different trigger sources (internal, external, and slave) have different delays, the system stores a value for each.

Trigger Skew requires a fast RF pulse ($T_{rise} < 10$ ns) to adjust 'Int' skew. To auto-adjust 'Ext' requires a fast RF pulse aligned with a fast external trigger pulse applied to the sensor's MIO input. Adjusting the 'Slave' source requires two sensors connected to a common, fast RF pulse ($T_{rise} < 10$ ns) and interconnected for cross-trigger via their MIO inputs. You can de-skew one setting at a time until all three sources are calibrated.

Deskewing can be done automatically by clicking on the double slope icon on the left of "ns", shown in figure ?? Automatic deskewing requires a fast edge, repetitive signal.

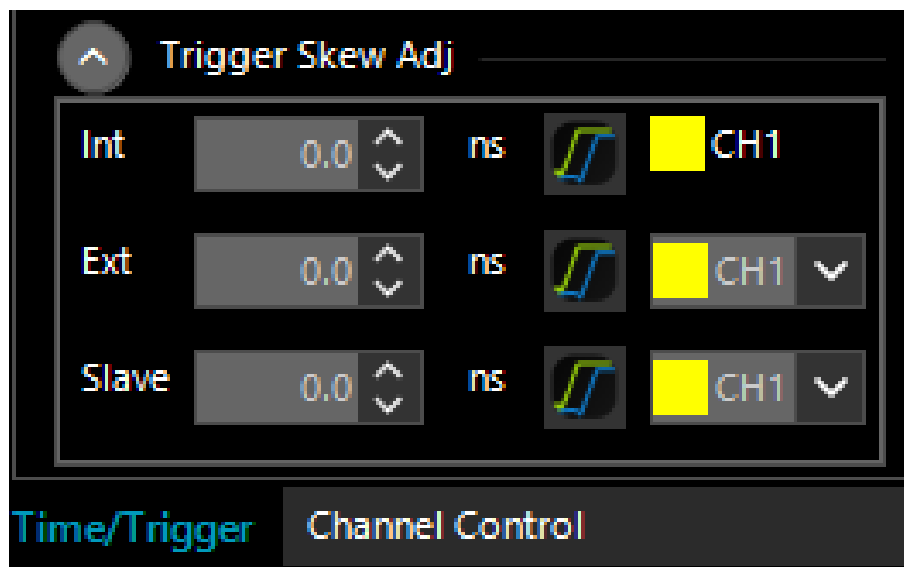



Figure 4.13 Trigger Skew Adj

4.1.7 Channel Control Window

The Channel Control window allows you to change all related settings to control sensor channels. The **Power Analyzer Software** has the capability of handling multiple control channels by selecting each individually from the drop-down list. Channel control setting is defined by several parameters as listed below:

Channel

You can select an individual channel or all measurement channels (for multichannel operation) by using the drop-down list. The channel labeled **MEM1** is a memory channel which is a reference trace that can be stored or recalled as need.

The  button causes the current trace to be stored in the Memory Channel. The current memory channel can be stored to the computer hard drive using the **Save Mem Chan** button in the Memory channel toolstrip. Likewise, a previously stored memory trace can be recalled using the **Upload Mem Chan** button.

To turn off the Memory Channel, select MEM1 or MEM2 from the Channel drop down menu, then click on the “On” button next to “Enabled” in the Sensor menu (see below) to select “Off”.

Info

The Info group shows the pertinent information for the selected sensor. Sensor model number, serial number, and firmware and FPGA versions for the selected channel are displayed in this group.

Pressing the **Advanced** button will result in a **Sensor Info** pop-up with three tabs: Sensor Data, Cal Factors, and Hardware Info.

Sensor Data contains identification and calibration information for the sensor.

Cal Factors contain the frequency response calibrations factors for both high and low bandwidth calibration.

Hardware Info contains information on the current state of the sensor hardware including the detector temperature and key power source voltage readings.

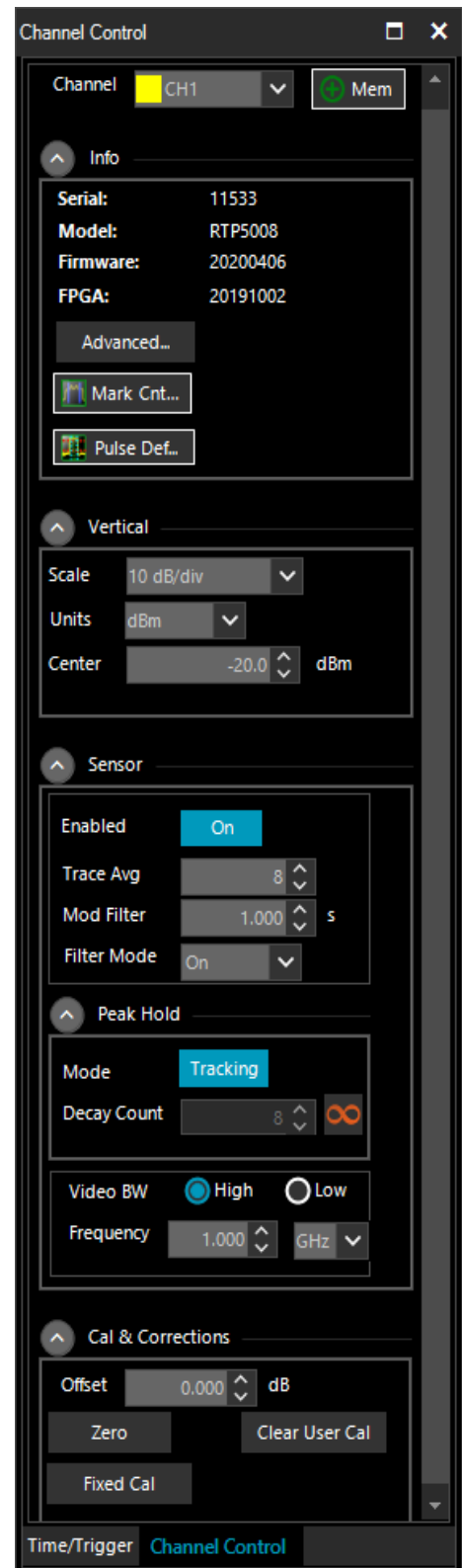

Figure 4.14 Channel Control Window

Vertical

The Vertical group contains controls that affect vertical settings for the selected power sensor.

Scale - Vertical scale sets the scaling of the level axis of the Trace View based on the selection of units as shown in table 4.2

Units	Scale
dBm	0.1, 0.2, 0.5 1, 2, 5, 10, 20, 50 dB/div
Watts	1 pW to 500 MW/div in a 1-2-5 progression
Volts	1 μ V to 100 kV/ div in a 1-2-5 progression

Table 4.2 Vertical Scale Range

Units - The trace presentation may be shown in units of dBm, Watts or Volts. The Units selection determines the range of the scale values. Note that the Units setting also affects text measurement values in the Measurement windows.

Center - Set the power or voltage level of the horizontal centerline of the graph for the specified channel in the selected channel units. The center position can be entered numerically or adjusted by using up and down arrow keys.

Sensor

The Sensor group controls acquisition parameters for the selected power sensor.

Enabled - Individual sensors or all the selected sensors can be enabled or disabled by using the alternate action On/Off button. This functionality also enables or disables the MEM channels.

Trace Avg – Trace averaging can be used to reduce display noise on both the visible trace, and on automatic marker and pulse measurements. Trace averaging is a continuous process in which the measurement points from each sweep are weighted (multiplied) by an appropriate factor and averaged into the existing trace data points. In this way, the most recent data will always have the greatest effect upon the trace waveform, and older measurements will be decayed at a rate determined by the averaging setting and trigger rate. This averaging technique is often referred to as 'exponential' averaging because averaging imposes a first-order Infinite Impulse Response (IIR) exponential filter with a time constant of "n" where n is the Trace Avg (number of averages) setting.

Sensor averaging can be set by selecting a number of averages from 1 (no averaging) to 16384 in binary steps using the up and down arrow buttons in the Trace Avg field.

Note:

For Time base settings of 200 ns/div and faster, the sensor acquires samples using a technique called equivalent time or random interleaved sampling (RIS). In this mode, not every pixel on the trace gets updated on each sweep, and the total number of sweeps needed to satisfy the average setting will be increased by the sample interleave ratio of that particular Time base. At all times the average trace is the average of all samples for each pixel, and the min/max are the lowest and highest of that same block of samples for each pixel.

Mod Filter sets the modulation filter integration time. It is used in modulated mode measurements and does not affect the pulse mode (triggered) measurements shown in the trace view. The modulation filter is a “sliding window” filter which averages samples taken within a time window whose duration is set by this field. All samples within the time window are equally weighted.

Filter Mode controls the modulation filter. The filter can be set to On (manual filter time setting), None (integration time is set to the minimum 1 ms value), or Auto (integration time automatically selected based upon input level).

Peak Hold settings control the operating mode of the selected channel's peak hold function. Peak Hold affects the envelope trace (if displayed) as well as peak or dynamic range marker and pulse measurements.

In **Tracking** mode, the maxima and minima traces “decay” towards the average with a time constant that is the same as the averaging setting. If averaging is set fast (Trace Avg is set to a low value), then the maxima and minima decay quickly (are not held very long) while long averaging (Trace Avg is set to a high value) settings yields a ‘flatter’ trace and maxima and minima peaks decay slowly back to the average power level.

In **Manual** mode the averaging and peak time constants are independent (do not track each other). Rather, peaks are held for a time proportional to the Decay Count setting. Decay Count can be set from 1 to 16384 and increments in binary steps.

Manual mode can be useful if you want to set averaging short to see short-term signal fluctuations from one trace to the next, yet want the peaks held for a long time to get a better feel of longer-term peak stress on your system.

The **Infinite Hold** button sets the Decay Count to infinity. Signal peaks and dips are held indefinitely and never decayed. This is useful for long-term monitoring for glitches, spikes, dropouts, or other intermittent signal events.

Note:

The effects of the peak hold, i.e. min/max decay, are only visible when the “envelope” or “min/max” display is enabled in the view options (See section 3.3.11 and the associated figure 3.18. The marker min/max values are always affected.

Video BW sets the sensor video bandwidth for the selected sensor. High is appropriate for most measurements, and the actual bandwidth depends upon the sensor model. Low bandwidth offers additional noise reduction for CW or signals with very low modulation bandwidth. If Low bandwidth is used on signals with fast modulation, measurement errors may result if the sensor cannot track the fast-changing envelope of the signal.

Frequency should be set to the RF frequency that is applied to the sensor for the current measurement. The appropriate frequency calibration factor from the sensor's calibration table will be interpolated and applied automatically. Application of this calibration factor compensates for the effect of variations in the flatness of the sensor's frequency response.

The power sensor has no way to determine the carrier frequency of the applied signal, so the user must always enter the frequency.

Cal & Corrections

The Calibration and Corrections group controls coarse and fine corrections to the measurements.

Offset - Sets a measurement offset in dB for the selected sensor. This is used to compensate for external couplers, attenuators or amplifiers in the RF signal path ahead of the power sensor.

Zero - Performs a zero offset null adjustment. The sensor does not need to be connected to any calibrator for zeroing. This action removes the effect of small, residual power offsets, and should be performed prior to low-level measurements. Note that there should be no RF signal applied to the sensor input prior to zeroing.

Fixed Cal - Performs a calibration at 0 dBm at the currently set frequency. This requires a calibrated 0 dBm (1.00 mW) signal source at the current measurement frequency.

4.1.8 Automatic Measurements Display

Clicking on the **AutoMeas** icon in the Measurement Control Toolstrip will bring up the Automatic Measurements window to the left of the Trace View as shown in figure 4.15. This window includes two related sub-windows, Pulse Measurements and Marker Measurements. The Pulse Measurements window shows the sixteen default field pulse parameters. The field pulse parameter measurements are computed with methods described in **IEEE Std 181™-2011** and detailed in Section 6 on pulse terms and definitions.

The Marker Measurements window shows twenty-one marker measurements.

Note:

All field parameters are customizable, can be edited or deleted from the list by selecting individual parameter fields and then by using right click button of the mouse. The whole table can be copied and pasted into a spreadsheet in order to make any custom report file along with captured screenshots by selecting export button as provided by the software.

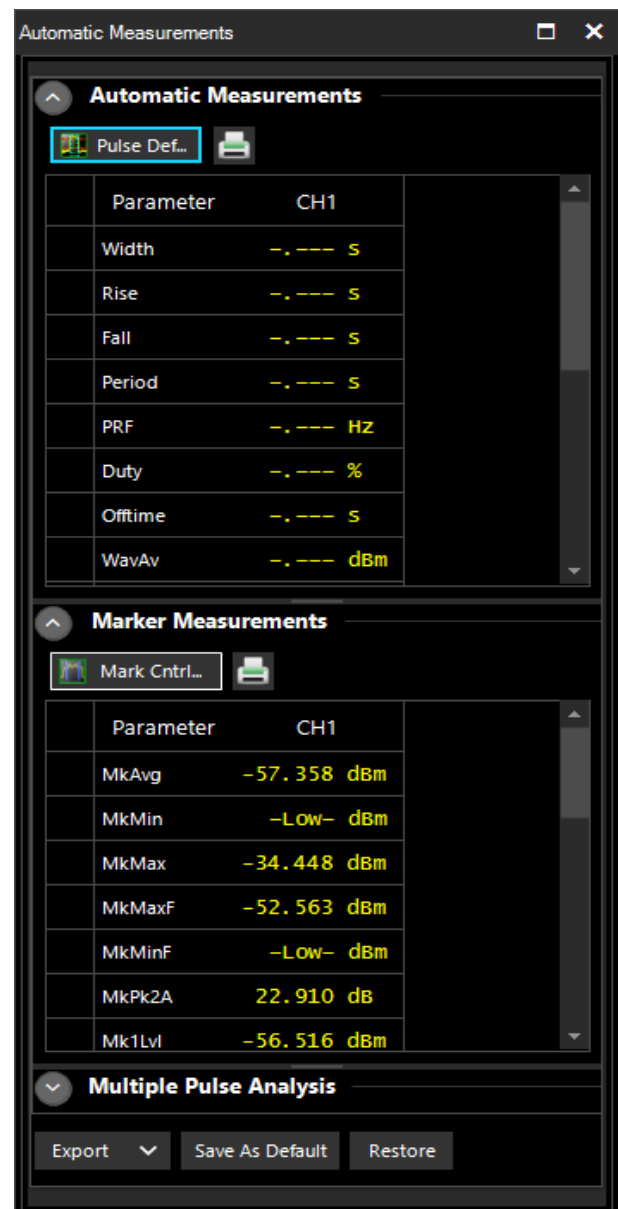

Figure 4.15 Automatic Measurements Window

Any individual parameter or group of parameters on pulse or marker measurements can be highlighted by left clicking with the mouse and using the up and down arrow keys a group of them can be selected. Selected cells can be copied by right clicking on the parameter(s) and selecting copy. The copied cells can be pasted into a spreadsheet or document.

Clicking on the printer icon next to either table will open a Print Preview window allowing the user to print the table.

Clicking on the **Export** button will open a viewer showing the whole table. The contents of the viewer can be saved or printed as PDF or CSV files, if desired.

4.1.9 Pulse Definition Window

Clicking on the **Pulse Def** button in the Pulse Measurement title bar or on the **Pulse Meas** button on the Measurement Control Toolstrip will open the Pulse Definitions window shown in Figure 4.11. This window contains the pulse thresholds, pulse analysis units and gate settings for the selected sensor.

Pulse Thresholds

Pulse definition settings allows user to define distal, mesial, and proximal values for pulse thresholds, and the pulse units.

Distal - Sets the pulse amplitude percentage that defines the end of a rising edge or beginning of a falling edge transition. Typically, this is 90% voltage or 81% power relative to the top level of the pulse. This setting is used when making automatic pulse risetime and falltime calculations.

Mesial – Sets the pulse amplitude percentage that defines the midpoint of a rising or falling edge transition. Typically, this is 50% voltage or 25% power relative to the top level of the pulse. This setting is used when making automatic pulse width and duty cycle calculations.

Proximal – Sets the pulse amplitude percentage that defines the beginning of a rising edge or end of a falling edge transition. Typically, this is 10% voltage or 1% power relative to the top level of the pulse. This setting is used when making automatic pulse risetime and falltime calculations.

Pulse Units – Controls whether the distal, mesial, and proximal thresholds are computed as voltage or power percentages of the top/bottom amplitudes. If Volts is selected, the pulse transition thresholds are computed as voltage percentages, and if Watts, they are computed as power percentages.

Many pulse measurements call for 10% to 90% voltage (which equates to 1% to 81% power) for risetime and falltime measurements, and measure pulse widths from the half-power (–3 dB, 50% power, or 71% voltage) points. The Pulse Units setting is independent of the channel's display units setting.

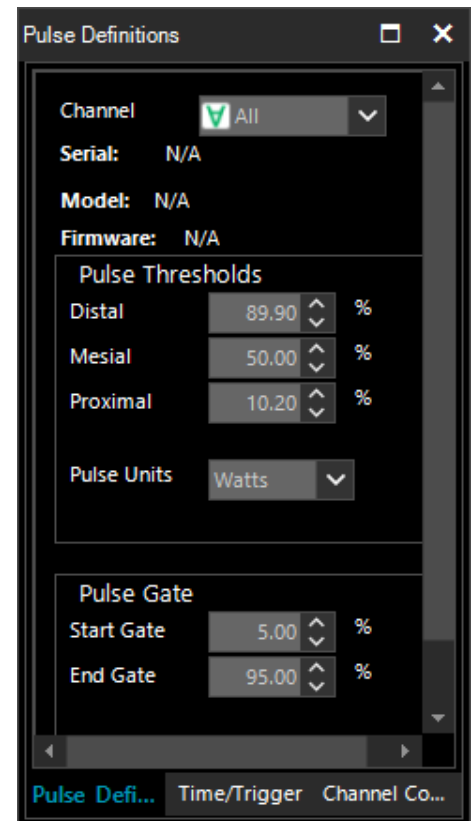

Figure 4.16 Pulse Definition Window

Pulse Gate

The Pulse Gate settings define the measurement interval for the following power related pulse measurements: Pulse Average, Pulse Peak, Pulse Minimum and Pulse Droop/Tilt. Pulse timing measurements between mesial crossings such as width and period are not affected. The purpose of the Pulse Gate setting is to exclude edge transition effects from the pulse power measurements. Automatic pulse measurements are then performed between Start Gate and End Gate points.

Start Gate - Sets the beginning of the pulse measurement region as a percentage of the pulse width. The Start Gate has a continuous range of 0.0 % to 40.0 % of the pulse width and may be entered numerically or varied using the up or down arrows.

End Gate - Sets the end of the pulse measurement region as a percentage of the pulse width. The End Gate has a continuous range of 60.0 % to 100.0 % of the pulse width and may be entered numerically or varied using the up or down arrows.

4.1.10 Marker Settings Windows

Clicking on the **Mark Ctrl** button in the Marker Measurement title bar or on the **Mark** button on the Measurement Control Toolstrip will open the Marker Settings window shown in figure 4.17. This window contains vertical marker locations, marker delta, and horizontal reference line locations for the selected sensor.

Markers

Time Markers are a pair of vertical cursors that allow level measurements at specific times relative to the trigger event. Markers can be moved to any portion of the trace that is visible on the screen, and these can be used to identify regions of interest for detailed power analysis. Power measurements can be performed at each marker, as well as average, minimum and maximum power in the time interval between the two markers.

Marker 1 and Marker 2

Marker settings will allow you to change both marker 1 and marker 2 positions by using either arrow keys or entering numerical values into the field. The Marker locations can also be set graphically by clicking on the marker in the Trace View and dragging the marker left or right.

Marker Delta

The Marker Delta window indicates the time interval between Marker 1 and Marker 2.

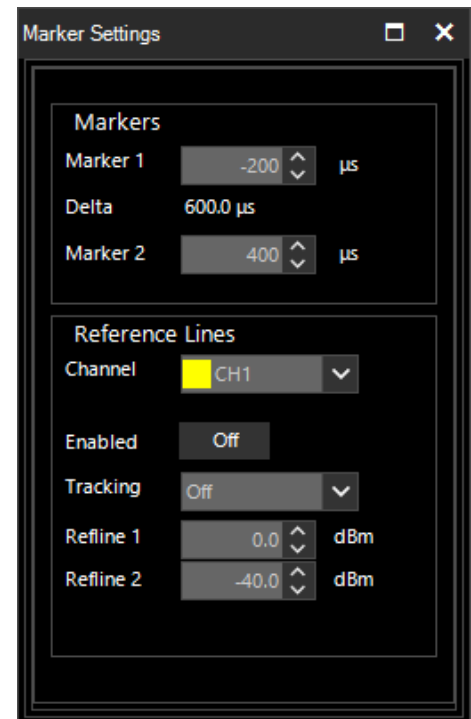

Figure 4.17 Marker Settings Window

Reference Lines

The reference lines, Refline 1 and Refline 2, are horizontal lines displayed on the Trace View. They can be used to indicate set amplitude levels for each sensor, or measurement-specific levels.

Channel

Selects the channel that the reference lines will be applied to.

Enabled

Turns the reference lines on or off for the selected channels. When off, reference lines are not visible.

Tracking

The Reference Line Tracking setting allows the selection of either manual control of the reference line amplitudes or selection of a set of commonly used reference amplitudes.

Off – Allows the reference levels to be set independently using the Refline 1 and Refline 2 entry fields. Levels can be entered numerically or by using the up and down arrows. The reference levels can also be set graphically by clicking on the reference line in the Trace View and dragging the line up or down. The vertical units match the Units selection in the Channel Control window.

Markers – Links the reference levels to the amplitudes where the markers cross the pulse waveform on the Trace View. Reference level Refline 1 will track the amplitude where Marker 1 crosses the pulse waveform and Refline 2 will track the amplitude where Marker 2 crosses the pulse waveform.

TopBottom – Moves Refline1 to the measured Top amplitude and Refline 2 to the measured Bottom amplitude.

DistalMesial - Moves Refline 1 to the measured distal (upper pulse threshold) amplitude and Refline 2 to the measured mesial (mid pulse threshold) amplitude. Pulse threshold levels are those set in the Pulse Definitions window.

DistalProximal - Moves Refline 1 to the measured distal (upper pulse threshold) amplitude and Refline 2 to the measured proximal (lower pulse threshold) amplitude. Pulse threshold levels are those set in the Pulse Definitions window.

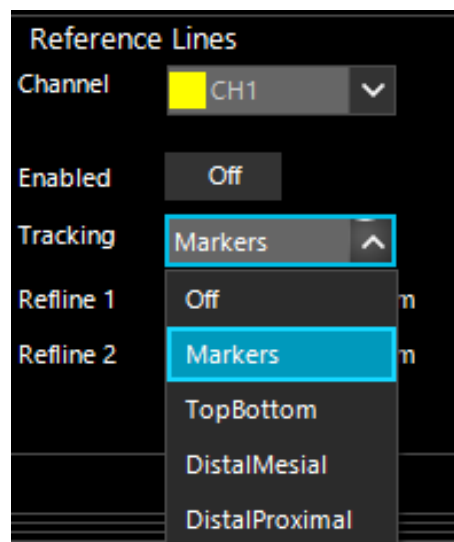

Figure 4.18 Tracking

4.1.11 Statistical CCDF Graph Display

The statistical analysis of the current sample population is displayed using a normalized Complementary Cumulative Distribution Function (CCDF) presentation shown in Figure 4.13. The CCDF expresses the probability of occurrence of a range of peak-to-average power ratios on a log-log scale, and a cursor (green diamond) allows measurement of power or percentage at a user-defined point on the CCDF. As with all other graphical displays, the trace can be easily scaled and zoomed, or the statistical data may be presented in a tabular format.

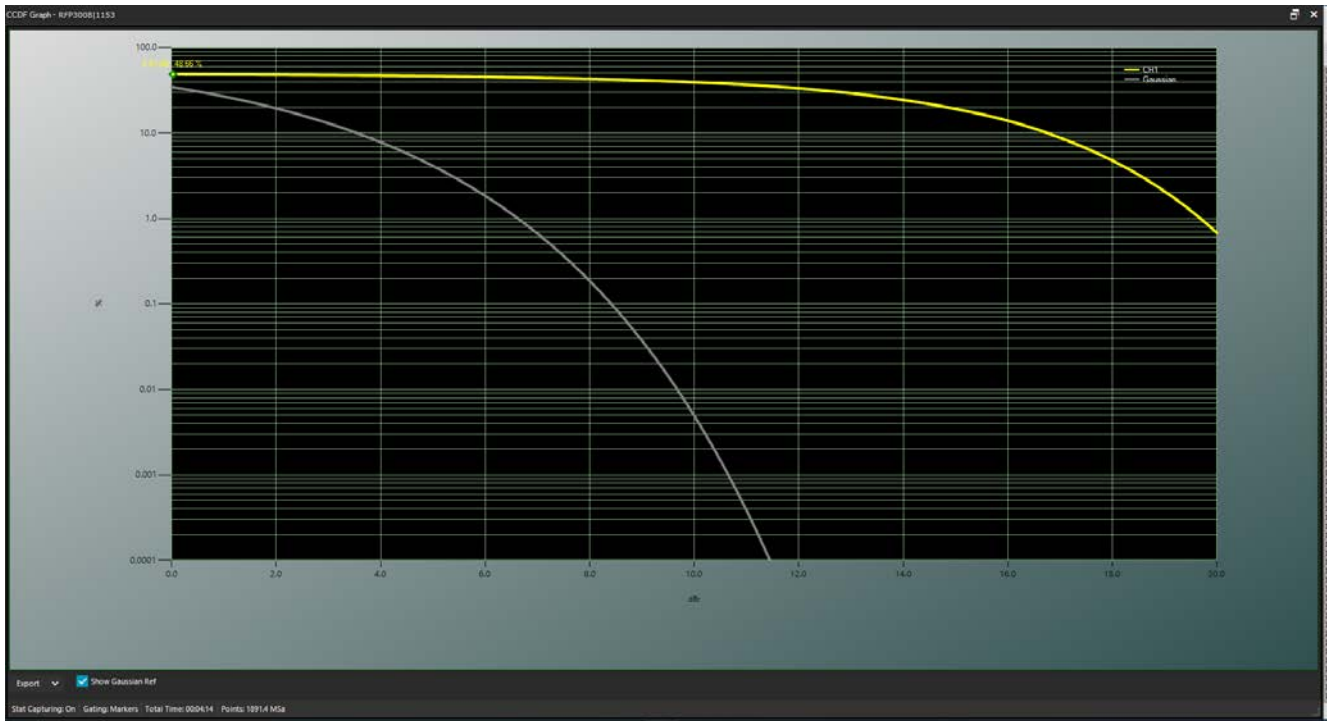

Figure 4.19 CCDF Graph

The CCDF has become a useful tool for analyzing communication signals that have a Gaussian like distribution (CDMA, OFDM) where signal compression can be observed at rarely occurring peaks. It is most often presented graphically using a log-log format where the X axis represents the relative offset in dB from the average power level and the log-scaled Y axis is the percent probability that power will exceed the X-axis value.

At the bottom of the CCDF Graph window is a status bar reporting Stat Capturing status (On or Off), Gating type (Markers or Freerun), Total Time (HH:MM:SS) and the number of Points (Mega Samples) in the statistical population.

Additionally, there is an Export button and a Show Gaussian Ref check box. Clicking on the Export button will bring up a Viewer pop-up window offering the ability to export the CCDF Graph in PDF or CSV format. Actuating the **Show Gaussian Ref** displays a Gaussian CCDF reference curve on the graph, as shown in figure 4.19.

4.1.12 Statistical Mode Control Window

The **Stat Mode Control** window, shown in figure 4.20, will appear when the CCDF Graph is displayed or by pressing the **Stat Ctrl** button on the Control Windows toolbar. The Stat Mode Control window controls the data acquisition for the CCDF Graph.

Capture – Select “On” to begin acquiring samples. “Off” stops the acquisition.

Reset – Clicking on Reset clears the acquired statistical sample population. If Capture is ON, a new acquisition will begin.

Term Action – Selects the action to take when either the terminal count is reached or the terminal time has elapsed. The available choices are Stop, Restart, or Decimate.

Stop - Stop accumulating samples and hold the result.

Restart - Clears the statistical sample population starts a new one.

Decimate - Divide all sample bins by 2 and continue. The total sample count will be halved each time decimation occurs. This should have very little visible effect on the CCDF values, since the entire population is decimated uniformly and the shape of the distribution is maintained.

Term Count – Sets the terminal sample count for the CCDF acquisition. The range of values is 0.1 to 1,000,000 mega samples.

Terminal Time – Terminal Time sets the terminal running time for the CCDF acquisition. The range of values is 1 to 3600 seconds.

Horiz Offset – Horiz(ontal) Offset sets the horizontal offset for the CCDF Graph statistical display. The value in dB_r chosen will appear at the leftmost edge of the graph. The range of values is -50.00 dB_r to +50.00 dB_r.

Horiz Scale - Selects the horizontal scale for CCDF Graph statistical display. Scale factors are from 0.1 to 5 dB/div in a 1-2-5 progression.

Cursor Type - Select the independent variable for the CCDF cursor. If Percent is selected, relative power at the cursor's intersection with the CCDF curve will be measured. If Power is selected, probability at the cursor's intersection with the CCDF curve will be measured.

Cursor Pos – Sets the CCDF cursor to the desired probability or power depending on the setting of Cursor Type.

Gating – Selects Marker or Freerun gating for statistical acquisition. If Markers are selected, then only samples within the time marker interval on the Pulse Mode triggered sweep will be included in the statistical sample population. If Freerun is selected, then all the samples are acquired without regard to sweep acquisition.

Mark Ctrl – Clicking on this button will bring up the Marker Settings window allowing Marker locations to be set easily when marker gating is used for statistical capture.

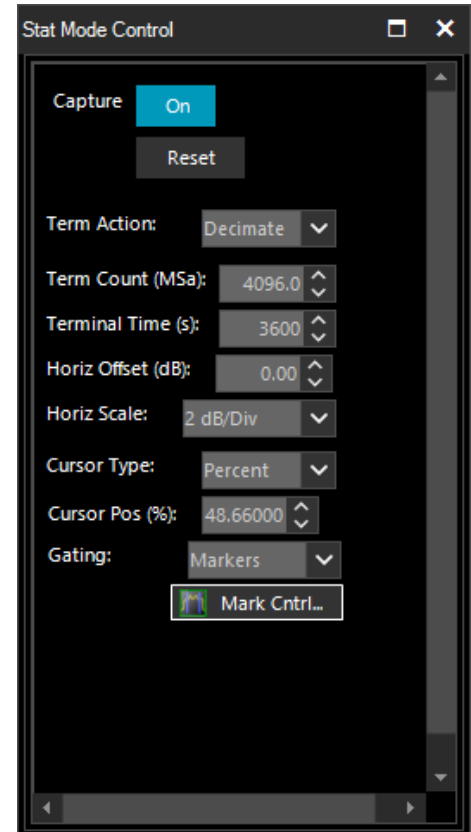

Figure 4.20 Stat Mode Control

Statistical Measurements Display

Clicking on the Stat Meas icon on the Measurement Control toolstrip brings up the Statistical Measurements window shown in figure 3.20. This display of tabulated field parameters is displayed on the left side of the CCDF Graph by default.

These key statistical parameters are described in table 4.3.

Parameter	Measurement Description
10% to 0.0001%	Displays crest factor relative to population average power at each specified %CCDF.
Pct at 0 dB	Displays %CCDF at the average power.
Cursor Pct	Displays %CCDF at the stat mode cursor.
Cursor Pwr	Displays crest factor relative to population average power at the Stat Mode cursor.
Average	Displays absolute average power of the statistical sample population.
Max	Displays absolute maximum power.
Min	Displays absolute minimum power.
Peak/Avg	Displays crest factor (pk/avg ratio).
Dynamic Rng	Displays dynamic range (max/min ratio).

Table 4.3 Statistical Parameters

At the bottom of the Statistical Measurements window status is reported by four fields: Stat Capturing status (On or Off), Gating (Markers or Freerun), Total Time (HH:MM:SS), and number of Points (Mega samples) in the statistics. Additionally, there is an Export PDF button. Clicking on the Export PDF button will bring up a PDF Viewer pop-up window offering the ability to export the CCDF Graph in PDF format.

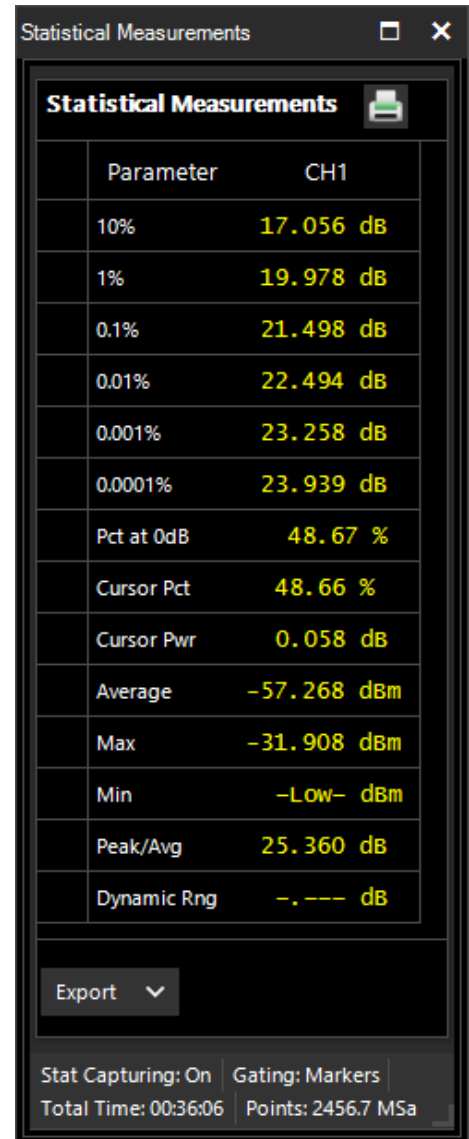

Figure 4.21 Statistical Measurements

4.1.13 Meter View

Meter view uses Modulated Measure Mode which is designed for continuous, true average power measurements of complex modulated signals. The mode is similar to the operation of a conventional CW power meter, but does not suffer the measurement inaccuracies that occur when some diode sensors are used to measure modulated signals.

Modulated measurement mode is a continuous measurement mode primarily for continuously modulated or CW signals. Continuous (untriggered / free run) sample acquisition is performed using “sliding window” filtering on the samples. Filtered average power, peak power and minimum power measurements are continuously performed. The measured result is the average power of the signal. Since the graphic display would basically just show a straight line, measurements in this mode are best viewed using the Modulated Measurements display window. Figure 4.22 shows a Modulated Mode measurement displaying the average, minimum and maximum power in modulated signal.

Since this mode performs a continuous measurement, it does not differentiate when a pulsed or periodic signal is off, and when it is on. If you wish to make measurements that are synchronous with a period of a waveform, consider using a triggered sweep and marker analysis instead.

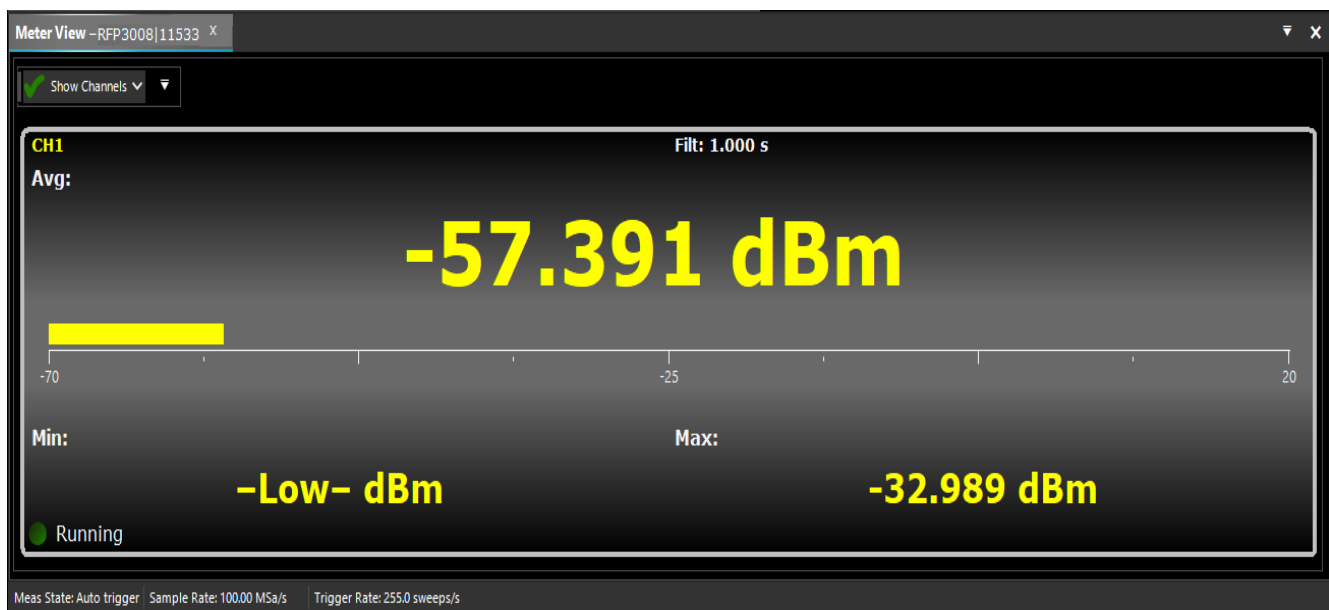

Figure 4.22 Meter View

Note:

The RFP3000 RF Peak Power Sensors belong to the family of Peak Power sensors which respond to the amplitude modulation of a modulated carrier.

Constant amplitude modulation schemes such as frequency and phase modulation (FM/PM) can be considered as a continuous wave (CW) carrier for power measurement purposes.

The trace View display for a CW, PM/FM modulated (PSK, QPSK, etc) signal will appear as a flat line trace in the time domain.

Modulated Measurement is recommended for measuring the following signal types:

- Noise-like digitally modulated signals such as CDMA and OFDM when only average measurements are needed.
- When simple, non-synchronous measurements on a periodic or non-periodic signal are needed (overall average and peak power).

Modulated Measurement controls can be found on the **Channel Control** panel's **Sensor** section.

Modulation Filter Mode sets the current setting of the integration filter on the selected channel.

Off provides minimal filtering (1 ms integration window), and can be used at high signal levels when minimum settling time is required.

On allows a user-specified integration time as entered in the **Mod Filter** setting.

Auto uses a variable amount of filtering, which is set automatically by the power meter based on the current signal level to a value that gives a good compromise between measurement noise and settling time at most levels.

Mod Filter sets the current length of the modulation mode integration filter on the selected channel when Filter Mode is set to On. The integration time can be set from 2 milliseconds to 2.048 seconds in 1 ms increments.

4.1.14 Acquisition Status Bar

The acquisition status bar provides useful information on the acquisition setup. The sampling rate and trigger rate are not reported in any other control window. Both are affected by the Time base setting in the Time/Trigger Control window.

Figure 4.23 highlights the acquisition status bar in blue. This bar, located beneath the graphical display, contains three status readouts: Meas State, Sample Rate and Trigger Rate.



Figure 4.23 Acquisition Status Bar

4.1.15 Archiving Measurement Setups

Measurement setups can be stored and recalled using the Save and Load buttons under the File tab as shown in figure 4.24.

Once the **Power Analyzer Software** has been configured for a particular measurement, the application state can be saved by pressing the **Save** button. After pressing the Save button the user is prompted to enter a file name and path to save the measurement state. Measurement States are stored in BKPrecision.BMS file format.

Saved measurement states can be recalled using the Load button. When activated it prompts the user to choose the desired .BMS file. Upon selection the desired measurement state is restored.

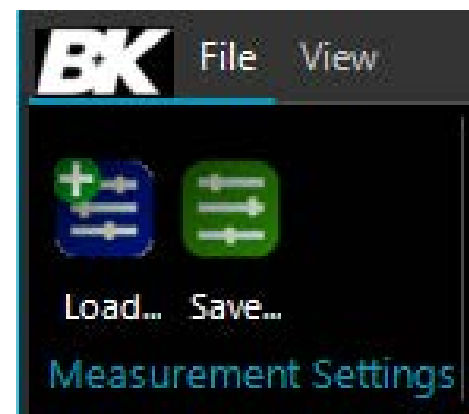

Figure 4.24 Load and Save

4.2 Multichannel Operation

The **Power Analyzer Software** supports simultaneous operation of up to eight RFP Series Sensors. Figure 4.25 shows an example using two power sensors. The Trace View shows both power traces each in a distinct color which matches the annotation.

4.2.1 Multichannel Measurement

When multiple sensors are connected to the USB ports of the computer, make sure all sensors are displayed in the Available Resources. If certain sensors are not selectable, this means they are already assigned to a virtual power analyzer. All sensors in a virtual power analyzer will be displayed on the same Trace Window, if enabled.



Figure 4.25 Multichannel Measurements

The Channel Control selection list offers control of individual sources CH1, CH2, ...,CH8 as well as corresponding memory channels MEM1, MEM2, ..., MEM8 and ALL. If an individual measurement or memory channel is selected, then the channel control settings will only affect that channel. If ALL is selected, then the channel control settings affect all measurement simultaneously (memory channels are not grouped with some “ALL” settings). The Time base settings are common to all measurement channels displayed with the same Virtual Power Analyzer instance.

Multichannel Automatic Measurement

Clicking on the Auto Meas button on the measurement toolstrip will display the pulse measurement and marker measurement windows. Note, in Figure 4.19, that pulse and marker measurements now show measurements for each active sensor. Pulse definitions, like channel control, can be applied to each trace source individually or to all sources simultaneously. Marker location settings, being time locations, are common to all traces. Reference Lines are also associated, individually, with each displayed trace. Reference lines are color coded to match each trace.

Multichannel CCDF Graph View

Statistical analysis behaves identically to the trace view. Both channel CCDF traces will be displayed on a common axis. Statistical measurements will have a measurement column for each sensor as shown in figure 4.26.

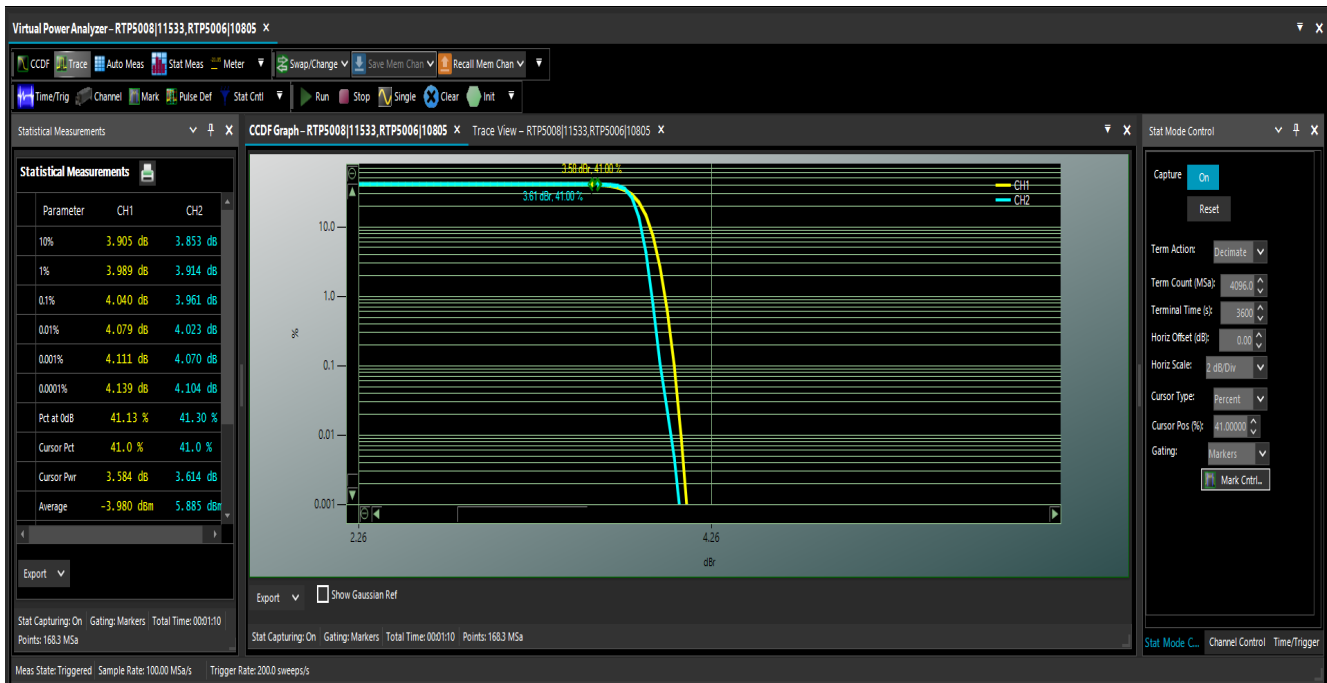

Figure 4.26 CCDF Graph Multichannel Operation

Similar to the Trace View there is a color-coded trace for each sensor in the CCDF Graph View displayed on a common grid. Statistical Mode controls affect all traces in the common display.

Statistical Measurements are listed with a column for each sensor in the common multichannel tab.

4.2.2 Multichannel Triggering

When more than one sensor is present, there are different triggering options as shown in figure 4.28

Triggering Options

Unless they are intended to be triggered independently, power sensors should be connected to each other using the Multi-I/O connector as shown in figure 4.27. To establish a communications path between the modules, a "trigger sync bus" is used to control both arming and triggering.

Multi-Channel Internal Triggering

When the Trigger Source for a multi-channel Virtual Power Analyzer is set to CH1, CH2, etc, one of the connected sensors is used as a common trigger for all channels. To facilitate this, the Multi-I/O connectors of all active sensors (channels) must be interconnected to create a "trigger distribution bus". The "master" sensor (selected trigger source) detects the trigger condition and distributes that event to other "slave" sensors to ensure synchronized triggering of all channels.

Figure 4.28 illustrates this connection. Note when three or more channels are present, a "tee adapter" will be required to interconnect all in parallel

Due to propagation delays in the master-to-slave trigger distribution, there is a small amount of timing skew between the master and slave channels. Sensors come pre-adjusted to minimize this skew, but it is possible to perform a fine trigger skew adjustment for performing critical channel-to-channel timing measurements. See the Trigger Skew Adjust paragraph in Section **Time/Trigger Control Window**, Trigger Setup.

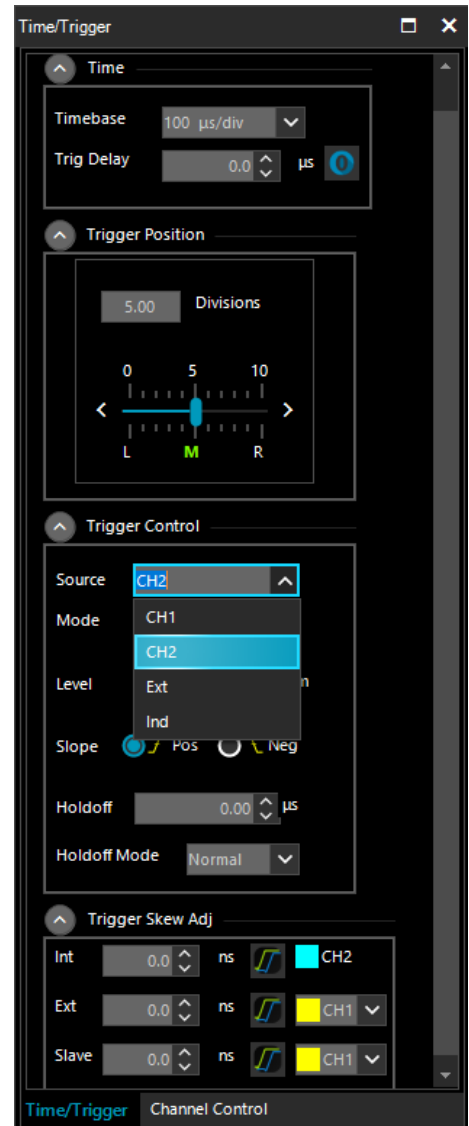

Figure 4.27 Multi Channel Trigger Source Selection

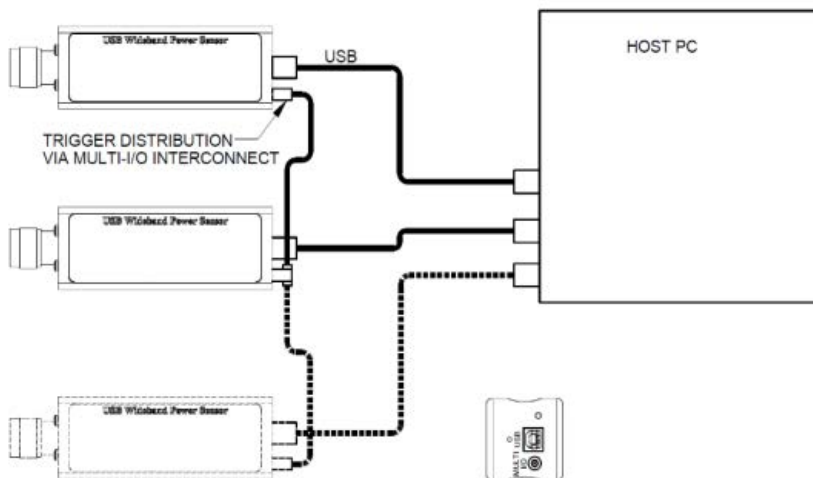

Figure 4.28 Coupling Multi-I/O Ports

External Triggering

When the Trigger Source for a single or multi-channel Virtual Power Analyzer is set to EXT, a single user-supplied TTL signal is used as a common trigger for all channels. To facilitate this, the Multi-I/O connectors of all active sensors (channels) must be driven by the external trigger signal to ensure synchronized triggering of all channels.

Figure 4.29 illustrates this connection. When two or more channels are present, a "tee adapter" will be required to drive all Multi-I/O connectors in parallel.

Due to propagation delays in the external trigger system, there is a small amount of timing skew between the external trigger edge and RF signal for each channel. Sensors come pre-adjusted to minimize this skew, but it is possible to perform a fine trigger skew adjustment for performing critical channel-to-channel timing measurements. See the section on Trigger Skew adjustment in Section 4.1.5, Time/Trig Control Window.

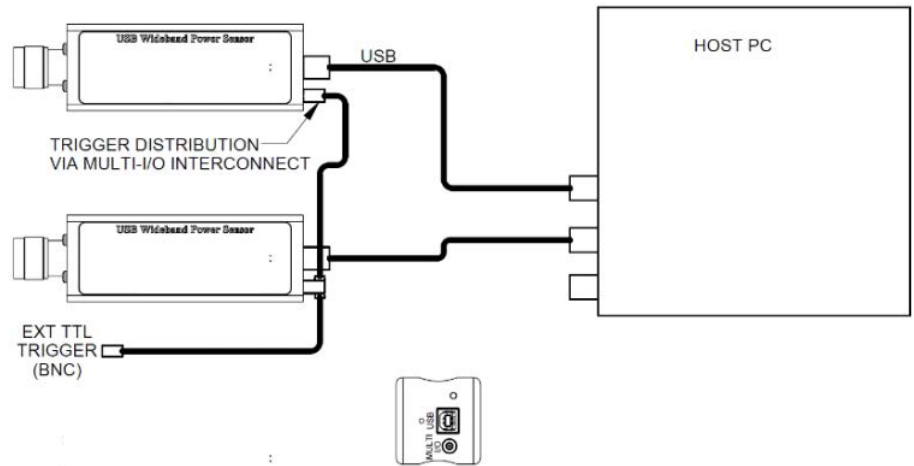

Figure 4.29 External Trigger Multi I/O Setup

Independent Triggering

Each sensor is internally triggered from its RF input signal. Select **Ind** from the drop-down menu of Source located in the Trigger Control panel of the Time/Trigger control window. Note that Ind source does not use the Multi-I/O connector.

4.2.3 Multichannel Individual Sensor Tabs

Multiple sensors can also be employed individually. Starting with multiple sensors listed in the Available Resources window, click on one sensor, then click the New Virtual Power Analyzer button. A Virtual Power Analyzer (VPA) tab will be opened listing the model and serial number of the selected sensor.

Click on another sensor in the Available Resources window and then click on the New Virtual Power Analyzer button again. A second VPA tab will be opened as shown in figure ???. This mode of multichannel operation treats each sensor individually. Select a VPA tab and all the control windows apply only to the selected sensor. Each VPA Trace View will show the selected sensor as Channel 1 (CH1). They are differentiated by the model and serial number listed on the tab. Likewise, all measurement windows will list measurements only for the selected sensor.



Figure 4.30 Mult-Cchannel Individual Sensor Tab

This creates two different instances of the Power Analyzer Software. To switch between them select the appropriate VPA tab. There is no option to add a second sensor to an existing single-channel VPA. The only way to do that is to close the VPA channel and restart as a multichannel VPA.

4.3 Measurement Buffer Mode(API remote programming only)

Measurement Buffer Mode for the RFP Series Sensors works in conjunction with Real Time Power Processing™ to provide all relevant burst information including timing, power and crest factor while eliminating the need to buffer, download and post-process large sample buffers.

Measurement Buffer Mode captures and analyzes the input signal during time intervals of interest and discards information that occurs during non-relevant intervals. This mode of operation performs most analysis in real-time during capture. The big advantage this measurement buffer mode offers to the user is that it reduces the stream of sample data to a single data record for each pulse, burst or event. Even for the fastest pulse rates, the data rate to the user is orders of magnitude less than the sample data rate, so in most situations it becomes possible to store and transfer power analysis results to the user in real time with no gaps in acquisition or analysis.

The Measurement Buffer Mode circuitry can analyze and buffer points at better than 2M buffered points per second (depending upon operating mode). The RFP Series Sensors internal measurement buffer can capture, analyze and store measurements for up to 2048 bursts at full rate. Additionally, a "circular" or FIFO capability allows continuous readout of buffered measurements by a host computer during capture and analysis. This real-time feature effectively removes the 2048 point internal buffer limitation, and permits capture and storage of test sequences of any size or duration to an external host measurement buffer. Continuous buffered capture is possible at sustained rates of better than 100K buffered points per second to a host memory array or disk file.

4.3.1 Buffer Overview

The RFP Series Sensors measurement buffer consists of 2048 buffer entries, each containing information about a unique time interval.

Buffer Entries. Each "Buffer Entry" contains the following measurement values for that time interval:

- Average interval power
- Peak interval power
- Minimum interval power
- Interval start time (relative to start time of first entry)
- Interval duration (time from start to end of interval)
- Entry count (buffer reading number - increments each entry)

A 32-bit "Entry Count" counter (called "sequence number" in the IVI driver) keeps track of how many buffer entries have been processed and stored.

Table 4.4 shows a sample measurement buffer consisting of seven buffer entries. In this example, the buffer consists of seven entries, each corresponding to a single burst.

Entry Count	Interval Start	Interval Duration	Interval Average	Interval Minimum	Interval Peak
0	0.00 us	5.01 us	-0.043 dBm	-39.042 dBm	8.826 dBm
1	9.99 us	5.00 us	-0.006 dBm	-38.431 dBm	8.827 dBm
2	19.99 us	5.01 us	0.039 dBm	-41.549 dBm	9.742 dBm
3	30.00 us	5.00 us	0.017 dBm	-38.551 dBm	9.802 dBm
4	40.01 us	5.00 us	0.022 dBm	-40.699 dBm	9.477 dBm
5	49.99 us	5.00 us	-0.020 dBm	-39.706 dBm	8.102 dBm
6	60.00 us	5.00 us	0.036 dBm	-37.803 dBm	9.750 dBm

Table 4.4 Example of Measurements Stored in Buffer

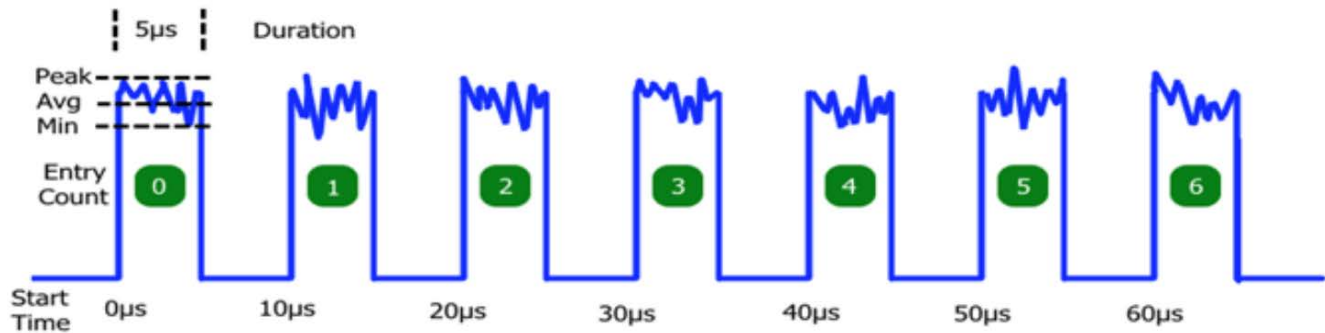

Figure 4.31 Sample Burst Signal

Buffer Gates. The measurement interval for each Buffer Entry is defined by a "gate" signal that controls the start and end of data acquisition for that entry. At the start of each gate interval, a fresh acquisition interval is initiated, and at the end of the gate, the acquisition interval is concluded and the result (the "buffer entry"), as shown in Figure 4.25, is written to memory. The gate signal may be internally or externally generated in several different ways - see "Gating Modes" section below.

Buffer Sessions. Each "Measurement Buffer Session" consists of a series of acquired buffer entries, stored in sequential order to an onboard memory. The duration of a session may be monitored and controlled by user command, by an external "run" signal, or limited to a preset number of entries or a preset time period. See "Session Arming" and "Session AutoStop" sections below. In the example above, the session consists of seven buffer entries, acquired over approximately 65 microseconds.

4.3.2 Measurement Buffer Mode Operation

Gating Modes. Each Buffer Entry is controlled by a "buffer gate" that defines the start and end of the entry time interval. The gate signal may be internally or externally generated in several different ways.

Marker Gate: Each buffer entry is "between markers" interval for one triggered sweep. This mode is used with the power sensor operating in triggered pulse mode, and the sweep system and markers are used to define the start and end of each gate interval. The entire gate interval must fall within the limits of the visible trace, so trigger and Time base settings must be appropriate for the signal.

Burst AutoGate: Each buffer entry consists of a single pulse or burst. The start and end of the burst are automatically identified by comparing the measured input signal to the trigger level threshold. Gate qualifying and delay options are available to align the gate interval with the desired portion of a burst.

External Gate: Each buffer entry consists of a single measurement interval gated by the logic state of the Multi-I/O input. Qualifying and delay options are available to align the gate interval with the Multi-I/O input.

External Trigger Gate: Each buffer entry is initiated by assertion of the Multi-I/O input and ends after a user-defined duration. Qualifying and delay options are available to align the gate start with the Multi-I/O input. If a qualified Multi-I/O assertion (rising edge) occurs prior to the programmed duration, the gate interval in progress will end immediately and a new interval will begin with no gap between intervals.

Periodic Gate: Buffer entries are self-timed intervals with user-defined period and duration. If period setting is less than or equal to duration setting, the period setting will be used for both and there will be no gap between successive intervals.

Acquisition of each entry begins upon assertion of the buffer gate, and concludes upon de-assertion of the buffer gate. When the gate interval starts, a fresh accumulation of power samples begins. When the entry interval ends, the accumulated power samples are processed to yield one set of avg/min/max and duration values for the entire interval, and this result is stored to the next available buffer location in memory.

Power samples are not accumulated when the gate is inactive. Buffer entries (gates) may not overlap, however gap-less buffering (zero "gate inactive" time) is possible in certain modes. In this case, a new gate interval begins immediately upon completion of the preceding gate interval.

Gate Qualify. If the Gate Mode is set for Burst AutoGate or External Gate/Trigger, additional criteria and time delays may be imposed to aid in aligning the gated measurement on a desired signal interval. Start and End qualifying values indicate the time that the controlling input (RF signal level or MIO external gate) must remain above or below the qualifying threshold (trigger level for RF input, TTL levels for MIO) to be recognized.

The Start qualifier can be used to reduce sensitivity to brief noise spikes while the burst is "off". Typically, the start qualify time will be short - perhaps 10 to 50 ns.

The End qualifier is commonly used to avoid premature burst end detection when burst modulation causes the RF signal to briefly fall below the qualifying threshold. For wideband modulation, this value must be longer than expected modulation dips, but shorter than intra-burst gaps - typically 50 to 200 ns.

The internal gate signal is automatically adjusted to align with the beginning of recognized qualifying intervals - no user adjustment is necessary. This means that the qualified gate which controls buffering will correspond to the actual start and end of the burst, and not be delayed by the qualifying times.

Gate Start/End Delay. If time adjustment of the qualified gate interval is needed to align the desired gate interval with signal timing, the start and end times may be delayed by a user-controlled value. Gate delays may be positive or negative to permit moving the gate interval ahead or back in time, respectively.

A positive start delay can be used to exclude the rising edge of a burst, or to exclude a training sequence of known duration. Similarly, a negative end delay will cause the qualified gate to end early, so can be used to exclude the falling edge of a burst.

Since all processing is done in real-time, a built-in signal FIFO is used to permit the "look-back" action necessary to start or end a gate interval prior to the qualifying event. Therefore, the difference of the qualifying time and gate delay for both the start and end gates cannot exceed the FIFO depth of 20 microseconds (implementation specific). This means that if the end qualify time is 2 us, the end delay may be no more negative than -18 us. To simplify settings control, the available time is split in half between the gate qualify and negative delay limits.

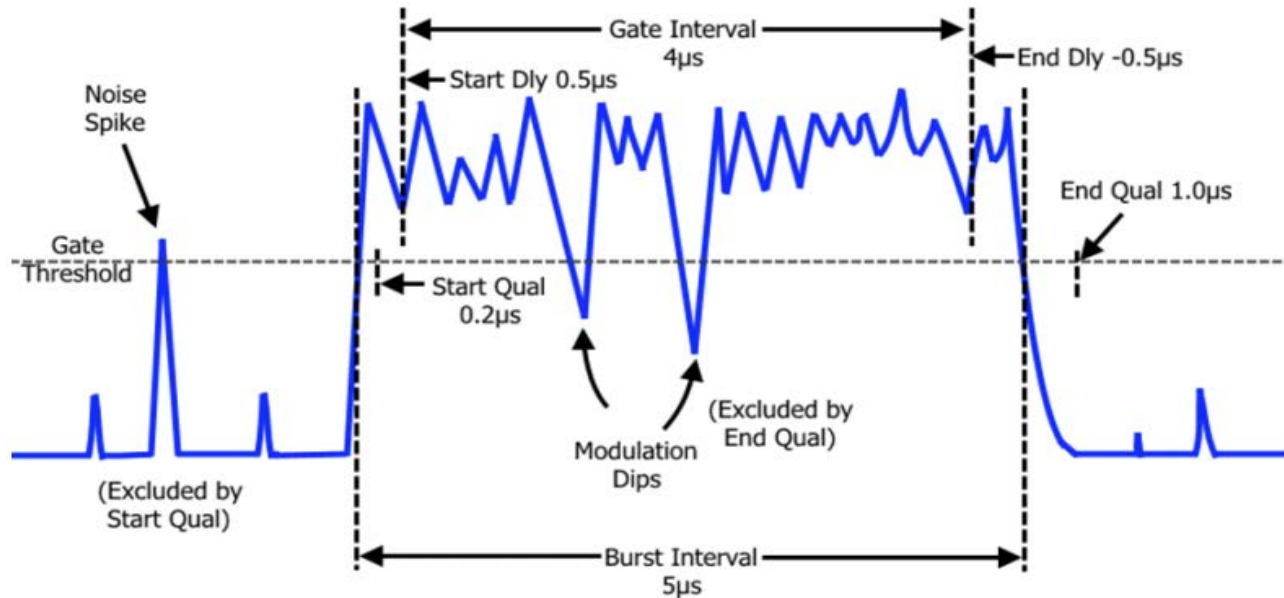

Figure 4.32 Gate Qualify and Delay

Figure 4.26 illustrates how gate qualify and delay options may be combined to align the desired buffer gate with a signal burst.

- The **StartQualify** time is set to 0.2 us so the start of the burst will only be recognized when the signal remains above the gate threshold for 0.2 us or longer. This ensures that brief noise spikes while the burst is off are not recognized as a valid burst.
- The **EndQualify** time is set to 1.0 us so the end of the burst will only be recognized when the signal remains below the gate threshold for 1.0 us or longer. This ensures that brief modulation dips during the burst do not prematurely end the gate interval.
- The **StartDelay** time is set to 0.5 us. This begins the gate interval 0.5 us after the beginning of the StartQualify interval and is used to exclude rising edge effects such as transition time or overshoot from the gate measurement.
- The **EndDelay** time is set to -0.5 us. This ends the gate interval 0.5 us before the beginning of the EndQualify interval and is used to exclude falling edge effects such as transition time from the gate measurement.

The entire qualified "burst interval" is 5 us long - starting and ending at the beginning of the StartQualify and EndQualify times. The final "gate interval" is offset at the start and end of the burst to exclude rising and falling edge effects. Therefore, the measured "duration" stored in the buffer for the 5 us burst shown will be about 4 us.

Session Arming (Start) control. Although buffered acquisition may be enabled ("running"), no data is collected unless the session is "armed" to accept gate signals (see "Gating Modes"). Recognition of the selected gate signal is controlled by arming or disarming the session.

When a session is armed, one buffer entry will be written to the buffer memory at the conclusion of each gate interval. When the session is not armed, gate signals are ignored, and no entries are saved. This permits a session to be launched or controlled via user software or an external signal.

The following settings are available to arm or control Measurement Buffer sessions.

- Immediate: The session is armed immediately - each valid gate signal will generate a buffer entry. The session remains armed until disarmed by other means (see "Session Stop" below).
- ExtStart: The session is armed upon assertion of an external start (arming) pulse on the Multi-I/O. Following arming, the buffer system will remain armed, and each valid gate signal will generate a buffer entry. The session remains armed until disarmed by other means (see "Session Stop" below).
- ExtEnable: The session is armed when the external enable signal to the Multi-I/O is asserted, and will remain armed as long as the Multi-I/O is asserted. If the Multi-I/O is de-asserted, the system disarms and sample acquisition halts. Asserting the Multi-I/O signal again re-arms and continues collecting buffer entries from the previous location - it does not reset the buffer.

At the start of any Measurement Buffer session, the buffer status is reset. This clears the entry count and discards any unread entries.

Session Auto-Stop conditions. Each Buffer Session may be automatically terminated - this disarms the session so no further entries are stored. Entries which have already been started are aborted without being written.

Automatic stop can occur in several ways:

- Counted: The current Measurement Buffer session is terminated when "N" buffer entries have been acquired during that session.
- Timed: The current Measurement Buffer session is terminated "T" seconds after the start of the session.
- ExtEnable: The current Measurement Buffer session is terminated upon de-assertion of an external buffer enable signal on the Multi-I/O.
- Overflow: The current Measurement Buffer session is terminated if the number of unread entries reaches the capacity of the buffer.

Note:

Auto-stop criteria are all examined. The session will terminate for whichever event occurs first. The auto-stop criteria can be disabled.

Mbuf Enable Modes. Overall control of the Measurement Buffer system is handled in much the same way as other measurements - user controls for "Run", "Stop" and "Reset" are available.

MbufEnable=ON:	Reset the Measurement Buffer system and enable a new Measurement Buffer session. Acquisition will begin with the first buffer entry once the system is armed (see "Session Arming (Start) control") and a valid gate signal is received (see "Gating Modes").
MbufEnable=OFF:	Halts any Measurement Buffer session in progress. If the gate is currently active, its acquisition data will be lost. This functions as a "stop" command and all acquired buffer data will still be available to read. Note that sessions may already be stopped due to "auto-stop" conditions being met.
MbufReset	Halts and clears the Measurement Buffersystem. This will force MbufEnable to OFF. The read count and write index are returned to zero and no buffer data will be available to read.

Buffer Read. Users may read the entire buffer contents once the session is complete, or may read any newly acquired entries while the buffer session is in progress. User settings control the maximum number of entries to be returned for each I/O read, up to the full capacity of the buffer. However, the number of returned entries will be limited to the number of "new" (acquired, unread) buffer entries.

Each time the user reads entries from the buffer, a read pointer is incremented by the number of entries returned, and subsequent user reads will return new buffer elements beginning with the first unread entry.

Circular/Continuous Buffer Acquisition. If the number of entries in a buffer session reaches the end of the measurement buffer without stopping, buffered acquisition will continue in circular fashion - that is entries will "wrap" and begin refilling the buffer from the start.

Ordinarily, this would overwrite the buffer contents, resulting in loss of acquired measurements. However, since users can read buffer sessions during acquisition, it is possible to periodically empty the buffer so overwrite of old data does not occur.

From a user perspective, the buffer appears as a 2048 element FIFO. Provided the user avoids FIFO overflow by reading the buffer periodically, the buffer entries may be stored externally by the user to create buffers of any size desired.

If the user is not able to read the buffer before overflow occurs, two options are available to control behavior:

Overflow Protection ON:	Overflow Protection ON: Enables auto-stop for pending buffer overflow. Buffer entries continue to be acquired in circular fashion provided the user periodically reads the buffer. But if the buffer fills to capacity (2048 unread entries) without being emptied, the session is terminated and no further entries are stored. This mode gives priority to the earliest acquired entries and ignores events after the session terminates. DEFAULT MODE.
Overflow Protection OFF:	Disables auto-stop for buffer overflow. Buffer entries continue to be acquired in circular fashion without regard to read status by the user. If the buffer fills to capacity (2048 unread entries) without being emptied, new entries will continue to be stored, and will overwrite the oldest entries. This mode gives priority to the latest acquired entries, and discards older events whether or not they have been read by the user.

4.3.3 Measurement Buffer Mode User Settings

The following settings, queries and controls are available with the applicable modes and argument options or numeric ranges shown. Note that this is the SENSOR command interface, and may not align exactly with the API interface. Please consult API documentation for available settings and queries.

Gate Settings

MbufGateMode	[MarkerGate BurstAutoGate ExtGate ExtTrigGate PeriodicGate]	
MbufGateStartQual	0.0 to 10 us	(BurstAutoGate, ExtGate and ExtTrigGate)
MbufGateStartDelay	-10 us to 100 ms	(BurstAutoGate, ExtGate and ExtTrigGate)
MbufGateEndQual	0.0 to 10 us	(BurstAutoGate and ExtGate)
MbufGateEndDelay	10 us to 100 ms	(BurstAutoGate and ExtGate)
MbufGatePeriod	100 ns to 10 s	(PeriodicGate)
MbufGateDuration	100 ns to 100 ms	(ExtTrigGate and PeriodicGate)

Session Control Settings

MbufStartMode	[Immediate ExtStart ExtEnable]	
MbufStopCount	1 to 1M rdgs	(<=0 disables counted auto-stop)
MbufStopTime	1 ms to 1000 s	(<=0 disables timed auto-stop)
MbufProtection	[on off]	Enables auto-stop for buffer overwrite
MbufEnable	[on off]	"run/stop" control
MbufReset	—	Stops and resets the measurement buffer session

Measbuf Readback Settings

MbufFetchCount	1 to 2048 Sets	Sets # of entries to be returned to user
MbufAvailCount?		Returns # of unread entries in MBUF
MbufFetchNext?		Returns next "MbufFetchCount " entries, incr ptr
MbufFetchIndex[?]		Sets or returns current read pointer index

Multi-I/O Priority: The RFP Series Sensors Multi-I/O connector may be used as input or output in several different ways. When conflicts occur, priority must be determined or undefined behavior will result.

Multi-Channel Operation: When synchronized buffering between multiple channels is required, the concept of "master" and "slave" will again be needed to ensure gate intervals align between sensors. The "Trigger Source" logic can be used here.

In all configurations requiring a separate master and slave, the supplied "TriggerSync" cable must be used to interconnect the Multi-I/O connectors of the master and all slaves. Where more than one slave is present, additional cables and a "T" adapter will be needed for the parallel connection.

The Multi-I/O connector is not required by the Measurement Buffer system in many Single-channel configurations

Mode	Master	Slave	Required Connections
Marker Gate	Pulse mode trigger out/arm status in signal to/from the Multi-I/O connector. Mbuf gate signal is internally generated by sweep system in each sensor.	Pulse mode trigger in/arm status out signal to/from Multi-I/O. Mbuf gate signal internally generated by sweep system using same marker settings as master, so will be synchronized.	Interconnect Multi-I/O inputs of master and all slaves.
Burst AutoGate	RF Burst is qualified/delayed by master to create the Mbuf gate. Master Multi-I/O outputs the Mbuf gate to all slaves.	Multi-I/O receives qualified/delayed burst-detect signal from master. Each slave operates in "Ext Gate" Mbuf mode, so will follow master.	Interconnect Multi-I/O inputs of master and all slaves.
External Gate	There is no "master" or "slave" for this mode. All Multi-I/O inputs receive the ExtGate signal from a user source to gate each Mbuf entry. Mbuf entries for all connected sensors start and end in sync upon assertion and de-assertion of user ExtGate signal.		Drive Multi-I/O inputs of all sensors from user-supplied External Gate logic signal.
External TrigGate	There is no "master" or "slave" for this mode. All Multi-I/O inputs receive the ExtTrigGate signal from a user source to initiate each Mbuf entry. Mbuf entries for all connected sensors start in sync upon assertion of user ExtTrigGate signal and end after user configured time duration.		Drive Multi-I/O inputs of all sensors from user-supplied External Gate logic signal.
Periodic Gate	Master uses internal period and duration timers to control start and end of each Mbuf entry. Multi-I/O of master outputs 100 ns "start pulse" at the start of each Mbuf period.	Slaves operate in External Trigger Mbuf mode. All slave Multi-I/O inputs receive the start pulse from master to initiate each Mbuf entry. Each slave times the duration to end each entry.	Interconnect Multi-I/O inputs of master and all slaves.

Table 4.5 Measurement Buffer Functions and I/O Connections

Driver for RTP Sensors Functionality: The API for RTP Sensors exposes all of the measurement buffer controls and functions described in this section. However, for most use cases, the API offers a simplified set of methods and properties to allow the user to specify an arbitrary number of measurements to capture. This allows the programmer to specify the pertinent modes and gate qualifications, acquire a user-specified number of measurements, and then retrieve the buffered measurement arrays.

For further information see the RTP Series Power Sensor Programming Reference.

Remote Programming

The RFP Series Sensors can be remote controlled using an Application Programming Interface (API). The API for RTP Sensors can be used by many programming environments and languages including C/C++, Python, Visual Basic, Visual C#, LabVIEW, MATLAB, and others. This API permits user applications to access power sensor control and measurement functions via a Dynamic Link Library (DLL). For more information, please see the RFP Series Power Sensor Programming Reference.

5.1 Communication Overview

User software interfaces with the sensor via an Application Programming Interface (API). Settings and measurements can be set and queried using functions and properties defined in the programming manual. The API communicates with the sensor using low level calls to Microsoft's Windows USB driver (WinUSB). WinUSB then sends and receives proprietary binary commands and responses from the sensor. Figure 5.1 shows a graphical representation of the data flow between a user application and an RFP Sensor.

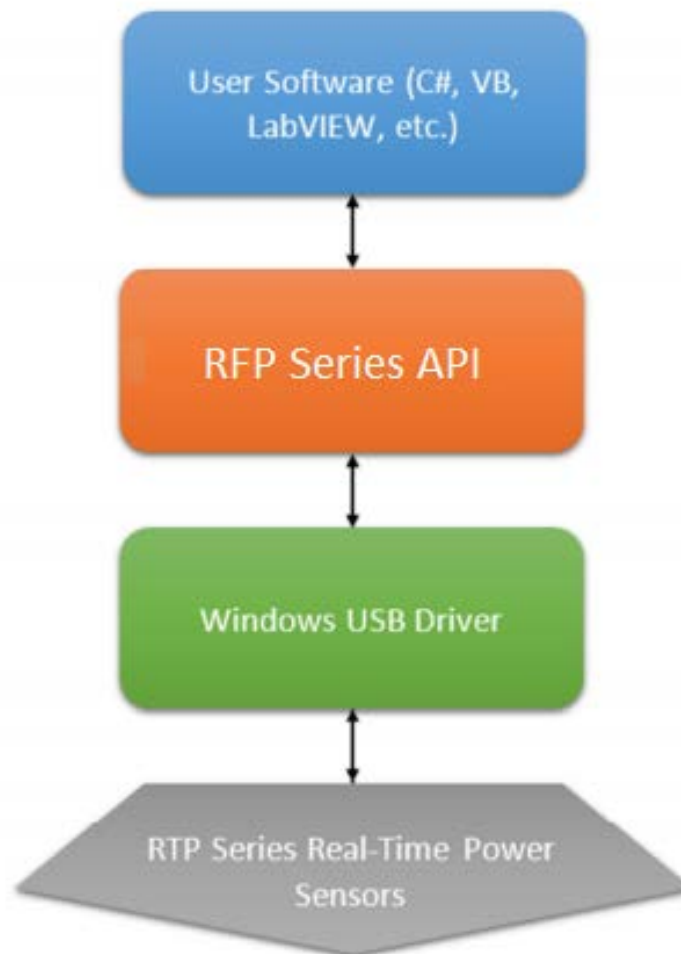

Figure 5.1 Communication Data Flow

Definitions & Measurements

This section provides definitions for key terms used in this manual and on the GUI displays as well as methodologies used to calculate automated pulse, marker and statistical measurements.

6.1 Pulse Measurements

6.1.1 Pulse Definitions

IEEE Std 181™-2011 IEEE Standard for Transitions, Pulses, and Related Waveforms, provides fundamental definitions for general use in time domain pulse technology. Several key terms defined in the standard are reproduced in this subsection, which also defines the terms appearing in the RTP Series Real-Time Power Sensors text mode display of automatic measurement results.

6.1.2 Standard IEEE Pulse

The key terms defined by the IEEE standard are abstracted and summarized below. These terms are referenced to the standard pulse illustrated in figure 6.1.

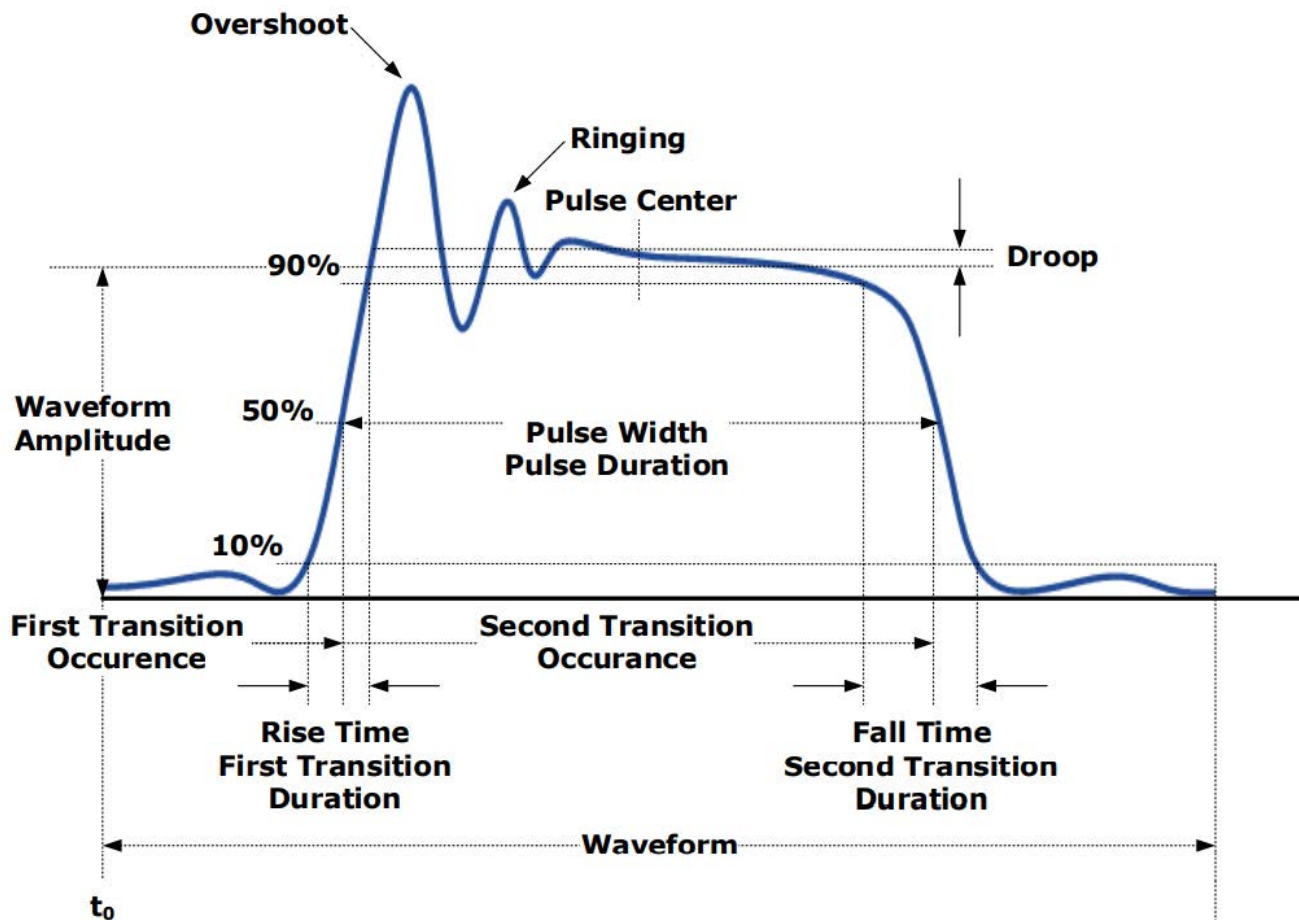

Figure 6.1 IEEE Standard Pulse

Note:

IEEE Std 194™-1977 IEEE Standard for Pulse Terms and Definitions has been superseded by IEEE Std 181™-2003 and -2011. Many of the terms used below have been deprecated by the IEEE. However, these terms are widely used in the industry and familiar to users of power meters. For this reason, they are retained.

TERM	DEFINITION
Base Line	The two portions of a pulse waveform which represent the first nominal state from which a pulse departs and to which it ultimately returns.
Top Line	The portion of a pulse waveform which represents the second nominal state of a pulse.
First Transition	The major transition of a pulse waveform between the base line and the top line (commonly called the rising edge).
Last Transition	The major transition of a pulse waveform between the top of the pulse and the base line. (Commonly called the falling edge.)
Proximal Line	A magnitude reference line located near the base of a pulse at a specified percentage (normally 10%) of pulse magnitude.
Distal Line	A magnitude reference line located near the top of a pulse at a specified percentage (normally 90%) of pulse magnitude.
Mesial Line	A magnitude reference line located in the middle of a pulse at a specified percentage (normally 50%) of pulse magnitude.

Table 6.1 Pulse Measurement Amplitude Threshold Terms

6.1.3 Automatic Pulse Measurements

The RFP Series Sensors and the Power Analyzer Software or API automatically analyzes the waveform data in the buffers and calculates key waveform parameters. The calculated values are displayed in Auto Meas window.

Table 6.2 summarizes the automatic field parameters available. Note that the Pulse Measurements can be edited and customized. Amplitude related parameters will be displayed in the same units as selected in the Channel Control Window.

Field Label	Parameter	Definition
Width	Pulse Width	The interval between the first and second signal crossings of the mesial line.
Rise	Risetime	The rising edge time interval from the first crossing of the proximal line to the first crossing of the distal line.
Fall	Falltime	The falling edge time interval from the last crossing of the distal line to the last crossing of the proximal line.
Period	Pulse Period	The time interval between two successive rising edges or two successive falling edges. (Reciprocal of the Pulse Repetition Frequency)
PRF	Pulse Repetition Frequency	The number of cycles of a repetitive signal that take place in one second.
Duty	Duty Cycle	The ratio of the pulse on-time to off-time.
Offtime	Off-time	The time a repetitive pulse is off. (Equal to the pulse period minus the pulse width).
WavAv	Waveform Average Power	Waveform Average Power
PulsAv	Pulse Average On Power	The average “on” power level across the pulse width, defined by the intersection of the pulse rising and falling edges with the mesial line, and offset by the StartGate and EndGate settings.
PulsPk	Pulse Peak Power	The maximum power level of the captured waveform OvrSht Overshoot Leading edge overshoot (The difference between the maximum amplitude of the overshoot and the top line).
Droop	Pulse Droop	Rise or Droop in amplitude between the start and end of the pulse, as defined by the StartGate and EndGate settings.
Top	IEEE Pulse Top Amplitude	The amplitude of the top line. (See IEEE definitions)
Bot	IEEE Pulse Bottom Amplitude	The amplitude of the base line. (See IEEE definitions)
EdgDly	Edge Delay	The delay time relative to the trigger of the first onscreen mesial level transition of either polarity. The Edge Delay value will be negative if the mesial transition occurs before the trigger event, and positive if it occurs after the trigger event.
Skew	Channel-to Channel Skew	The time between the mesial level of a pulse on Channel 1 and a pulse on Channel 2. The pulse can be the power or trigger signal.

Table 6.2 Automatic Measurement Parameters

6.1.4 Automatic Pulse Measurement Criteria

Automatic measurements are made on repetitive signals that meet the following conditions:

Amplitude: The difference between the top and bottom signal amplitudes must exceed 6 dB to calculate waveform timing parameters (pulse width, period, duty cycle). The top-to-bottom amplitude difference must exceed 13 dB to measure rise and falltime.

Timing: In order to measure pulse repetition frequency and duty cycle, there must be at least three signal transitions. The interval between the first and third transition must be at least 1/5 of a division (1/50 of the screen width). For best accuracy on rise and falltime measurements, the timebase should be set so the transition interval is at least one-half division on the display.

6.1.5 Automatic Pulse Measurement Sequence

The automatic measurement process analyzes the captured signal data in the following sequence:

1. Approximately 500 samples of the waveform (equivalent to one screen width) are scanned to determine the maximum and minimum sample amplitudes.
2. The difference between the maximum and minimum sample values is calculated and stored as the Signal Amplitude.
3. The Transition Threshold is computed as one-half the sum of the maximum and minimum sample amplitudes.

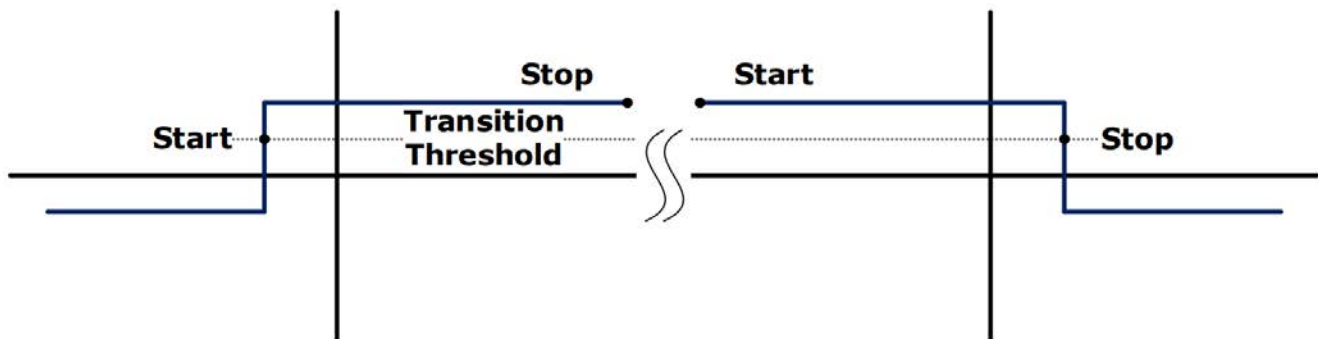

Figure 6.2 Step Waveforms

4. The processor locates each crossing of the Transition Threshold.
5. Starting at the left edge of the screen, the processor classifies each Transition threshold crossing according to whether it is positive-going ($- +$) or negative-going ($+ -$). Because the signal is repetitive, only three transitions are needed to classify the waveform, as shown in table 6.3.

Type	Edge Sequence	Description
0	none	No crossings detected
1	Not used	
2	+ -	One falling edge
3	- +	One rising edge
4	+ - +	One falling, followed by one rising edge
5	- + -	One rising, followed by one falling edge
6	+ - + -	Two falling edges
7	- + - +	Two rising edges

Table 6.3 Waveform Classification Types

6. If the signal is Type 0, (No crossings detected) no measurements can be performed and the routine is terminated, pending the next reload of the measurement buffers.
7. The process locates the bottom amplitude (baseline) using the IEEE histogram method. A histogram is generated for all samples in the lowest 12.8 dB range of sample values. The range is subdivided into 64 power levels of 0.2 dB each. The histogram is scanned to locate the power level with the maximum number of crossings. This level is designated the baseline amplitude. If two or more power histograms contain equal counts, the lower is selected.
8. The process follows a similar procedure to locate the top amplitude (top line). The power range for the top histogram is 5 dB and the resolution is 0.02 dB, resulting in 250 levels. The level-crossing histogram is computed for a single pulse, using the samples which exceed the transition threshold. If only one transition exists in the buffer (Types 2 and 3), the process uses the samples that lie between the edge of the screen and the transition threshold as shown in figure 6.2.
9. The process establishes the proximal, mesial, and distal levels as a percentage of the difference between top amplitude and bottom amplitude power. The percentage can be calculated on a power or voltage basis. The proximal, mesial, and distal threshold values are user settable from 1% to 99%, with the restriction that the proximal < mesial < distal. Normally, these values will be set to 10%, 50% and 90%, respectively.
10. The process determines horizontal position, in pixels, at which the signal crosses the mesial value. This is done to a resolution of 0.1 pixel, or 1/5000 of the screen width. Ordinarily, the sample values do not fall precisely on the mesial line, and it is necessary to interpolate between the two nearest samples to determine where the mesial crossing occurred. This process is illustrated in the example shown in figure 6.3.

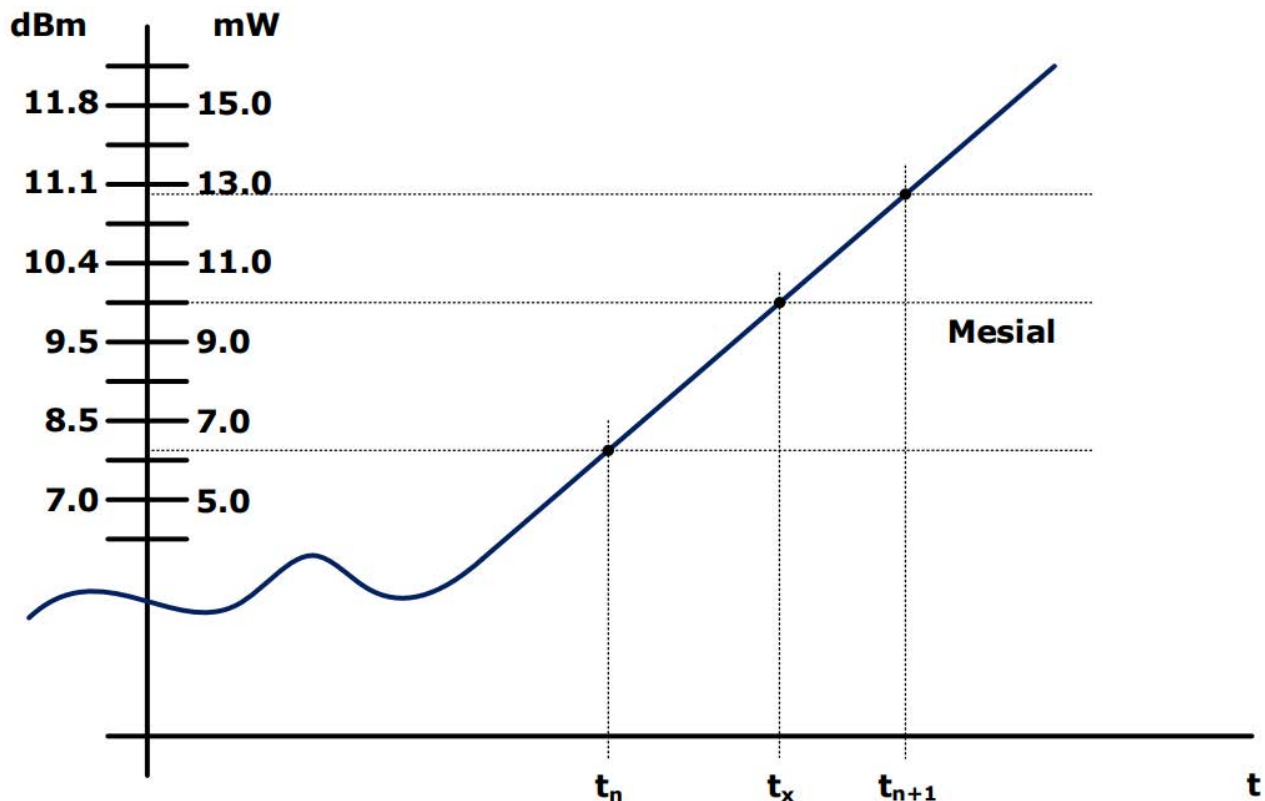

Figure 6.3 Time Interpolation Example

Item	dBm	mW
Mesial value	10.0	10.0
Sample n	8.0	6.3
Sample n + 1	11.0	12.6

Table 6.4 Time Interpolation Example

The interpolated crossing time, t_x , is calculated as follows:

$$t_x = t_n + \frac{P_{mes} - P_n}{P_{n+1} - P_n}$$

where P is in watts and n is the number of the sampling interval, referenced to the trigger event. For this example:

$$t_x = t_n + \frac{10.0 - 6.3}{12.6 - 6.3} = t_n + 0.6$$

11. The processor computes the rise and/or falltimes of waveforms that meet the following conditions:

- The waveform must have at least one usable edge (Types 2 through 7, as shown in table 6.4)
- The signal peak must be at least 13 dB greater than the minimum sample value.
The risetime is defined as the time between the proximal and distal crossings (– +).
The falltime is defined as the time between the distal and proximal crossings (+ –).
If no samples lie between the proximal and distal values for either edge (rise or fall), the risetime for that edge is set to 0 seconds.

12. The processor calculates the output values if applicable according to the following definitions:

- Pulse Width Interval between rising and falling edge mesial points
- Risetime See Step 11
- Falltime See Step 11
- Period Cycle time between successive mesial points of the same polarity
- Pulse Repetition Frequency Reciprocal of Period
- Duty Cycle Pulse Width/Period
- Off-time (Period) - (Pulse Width)
- Peak Power Maximum sample value between StartGate time and EndGate time (See Step 1)
- Pulse Power Average power between StartGate time and EndGate time
- Overshoot (Peak Power) - (Top Amplitude)
- Average Power See Step 13
- Top Amplitude See Step 8
- Bottom Amplitude See Step 7
- Droop between StartGate time and EndGate time
- Skew See Step 14

6.2 Marker Measurements

Table 6.5 summarizes the Marker Measurements available. Note that the Marker Measurements can be edited and customized. Amplitude related measurements will be displayed in the same units as selected in the Channel Control window.

Field	Label Parameter	Definition
MkAvg	Marker Average	Average power over marker interval
MkMin	Marker Minimum	Minimum instantaneous power over marker interval
MkMax	Marker Maximum	Maximum instantaneous power over marker interval
MkMaxF	Marker Maximum Filtered	Maximum average (filtered) power over marker interval
MkMinF	Marker Minimum Filtered	Minimum average (filtered) power over marker interval
MkPk2A	Marker Peak to Average	Peak-to-Average power ratio over marker interval
Mk1Lvl	Marker 1 Level	Average power at marker 1
Mk2Lvl	Marker 2 Level	Average power at marker 2
MkMaxAv	Marker Max Interval	Average Highest value of average-between-markers
MkMinAv	Marker Min Interval	Average Lowest value of average-between-markers
Mk1Min	Marker 1 Minimum	Minimum power or voltage at the Marker 1
Mk1Max	Marker 1 Maximum	Maximum power or voltage at the Marker 1
Mk2Min	Marker 2 Minimum	Minimum power or voltage at the Marker 2
Mk2Max	Marker 2 Maximum	Maximum power or voltage at the Marker 2
MkRatio	Marker Ratio	Ratio of Marker 1 to Marker 2
MkDelta	Marker Amplitude Difference	Amplitude difference between Marker 1 and Marker 2
MkRDelta	Marker Reverse Difference	Amplitude difference between Marker 2 and Marker 1
MkRRatio	Marker Reverse Ratio	Ratio of Marker 2 to Marker 1
Mk1Time	Marker 1 Time	Time at Marker 1
Mk2Time	Marker 2 Time	Time at Marker 2
MkTimeDelt	Marker Time Difference	Time Difference between Marker 1 and Marker 2

Table 6.5 Marker Measurements

6.2.1 Average Power Over a Time Interval

13. The average power of the signal over a time interval is computed by:

- Summing the power values at each point within the interval
- Dividing the sum by the number of points

This process is used to calculate Pulse Power, Average Power and the average power between markers.

Since each point represents the power over a finite time interval, the endpoints are handled separately to avoid spreading the interval by one-half pixel at each end of the interval (See figure 6.4). For the interval in figure 6.4, the average power is given by:

$$P_{ave} = \frac{1}{2}(P_0 + P_n) + \frac{1}{(n-1)} \sum_{n=1}^{n-1}$$

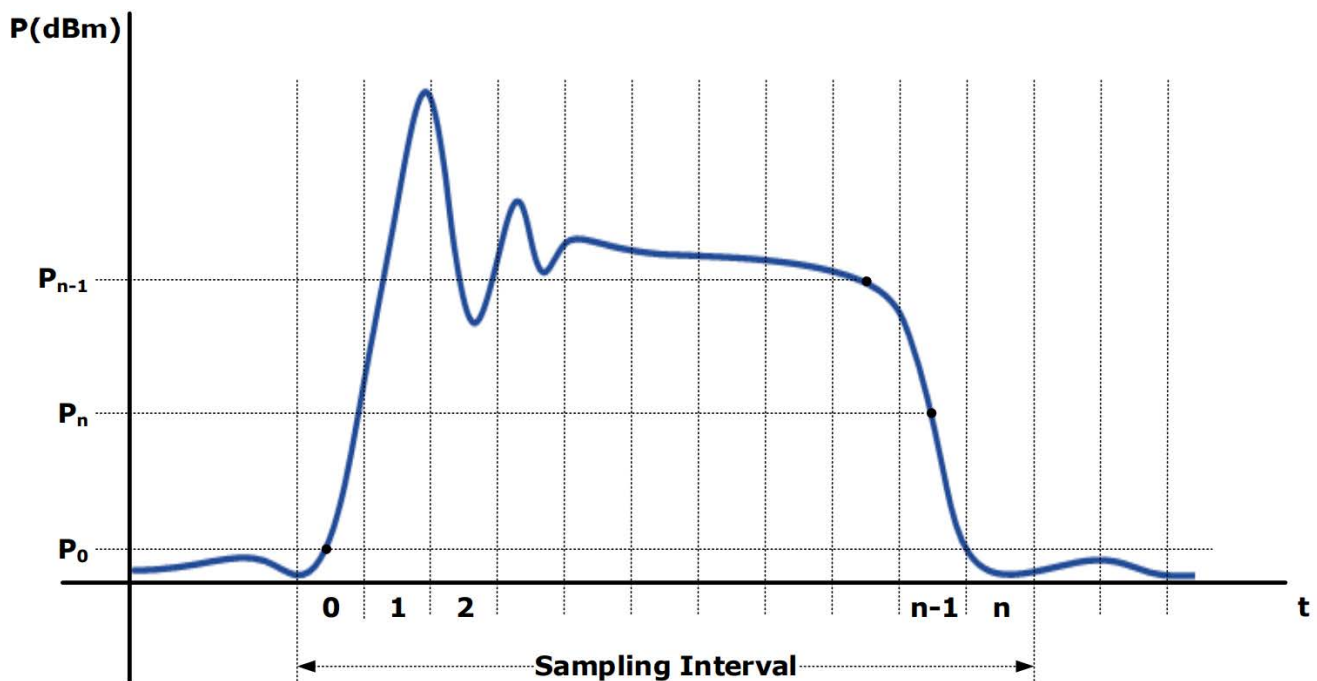

Figure 6.4 Sampling Intervals

14. To compute channel-to-channel Skew, the processor calculates the delay between the two measurement channels. The time reference for each channel is established by the first signal crossing (starting from the left edge of the screen) which passes through the mesial level (or 50% point in trigger view). The signal excursion must be at least 6 dB.

6.3 Automatic Statistical Measurements

Statistical Measurements based on the CCDF Graph are summarized in table 6.6

Field Label	Parameter	Definition
10%	Power at 10% probability	Peak to average power corresponding to 10% probability
1%	Power at 1% probability	Peak to average power corresponding to 1% probability
0.1%	Power at 0.1% probability	Peak to average power corresponding to 0.1% probability
0.01%	Power at 0.01% probability	Peak to average power corresponding to 0.01% probability
0.001%	Power at 0.001% probability	Peak to average power corresponding to 0.001% probability
0.0001%	Power at 0.0001% probability	Peak to average power corresponding to 0.0001% probability
Pct at 0 dB	Probability (percent) at 0 dB	Probability corresponding to 0 dB on the CCDF Graph
Cursor	Pct Cursor Probability (percent)	Probability at the Cursor Position on the CCDF Graph
Cursor Pwr	Cursor Power	Peak to average power at the Cursor position on the CCDF Graph
Average	Average	The unweighted average of all power samples occurring since acquisition started
Max	Maximum	The highest power sample occurring since acquisition was started
Min	Minimum	The lowest power sample occurring since acquisition was started
Peak/Avg	Peak/Average	Ratio The ratio (in dB) of the Peak Power to the Average Power
Dynamic Range	Dynamic Range	The ratio (in dB) of the Peak Power to the Minimum Power

Table 6.6 Automatic Statistical Measurements

Maintenance

This section presents procedures for maintaining the RTP Series Real-Time Power Sensors.

7.1 Safety Recommendation

The RFP Series Sensors have been designed in accordance with international safety standards. General safety precautions must be observed during all phases of operation and maintenance. Failure to comply with the precautions listed in the Safety Summary located in the front of this manual could result in serious injury or performance issues. Service and adjustments should be performed only by qualified service personnel.

Below are the safety recommendations for the RFP Series Sensors:

- Only rotate the connector nut, DO NOT use the sensor body or device to tighten the connector.
- Do not overtighten the RF connector.
- Do not use a connector with deformed threads, or a bent or broken conductor.
- Do not touch mating-plane surfaces with oily, or wax-like non-conductive substances.
- Do not apply a lateral force to the center conductor.

7.2 Cleaning

Painted surfaces and the RF connector can be cleaned very carefully with a mild cleaning solution (a solution of pure isopropyl or ethyl alcohol). Keep in mind its flammable nature. Clean water dampened in cloth can be used to clean the body of the RFP Series Sensors.

Note:



When cleaning the power sensor, do not allow any liquid to enter into the device. Avoid using chemical cleaning agents which can damage painted or plastic surfaces.

7.3 Inspection and Performance Verification

If an RFP Series Sensor malfunctions, perform a visual inspection of the instrument. Inspect for signs of damage caused by excessive shock, vibration or overheating. Inspect for broken or damaged connection port at sensor head, or accumulations of dust or other foreign matter. Correct any problems you discover and verify basic functionality with the **Power Analyzer Software**.

If desired, conduct a performance verification according to the procedure in the RFP Series Sensors Calibration and Verification Guide to verify that the instrument is properly recognized by the Windows OS and operational. If the malfunction persists or the sensor device fails the performance verification, contact BK Precision for service.

7.4 Connector Care

The most common cause of power sensor problems is excess input power. Applying power exceeding the labeled damage levels will damage the sensing elements such that its voltage versus power relationships are changed, resulting in erroneous

power readings.

The other most common cause of power sensor problems is damaged connectors. Connections should be tightened with the proper torque wrench applied to the coupling nut only. Any attempt to torque or un-torque a connection using the body of the power sensor may result in either connector damage, or in the connector becoming unthreaded from the body.

The following handling precautions must be observed to prevent connector damage when using the RFP Series Real Sensors.

- Keep connectors clean and protect using the plastic end caps provided with each sensor.
- Inspect connectors regularly and look for metal debris, scratches or dents.
- Clean contact surface and threads with clean, dry compressed air.
- Align connectors first and only rotate the connector nut.
- A precision type “N” connector is recommended for the RF line signal source connection.
- After proper alignment, rotate the connector nut by hand to connect or disconnect the connector of the sensor from a signal source as shown in figure 7.1.

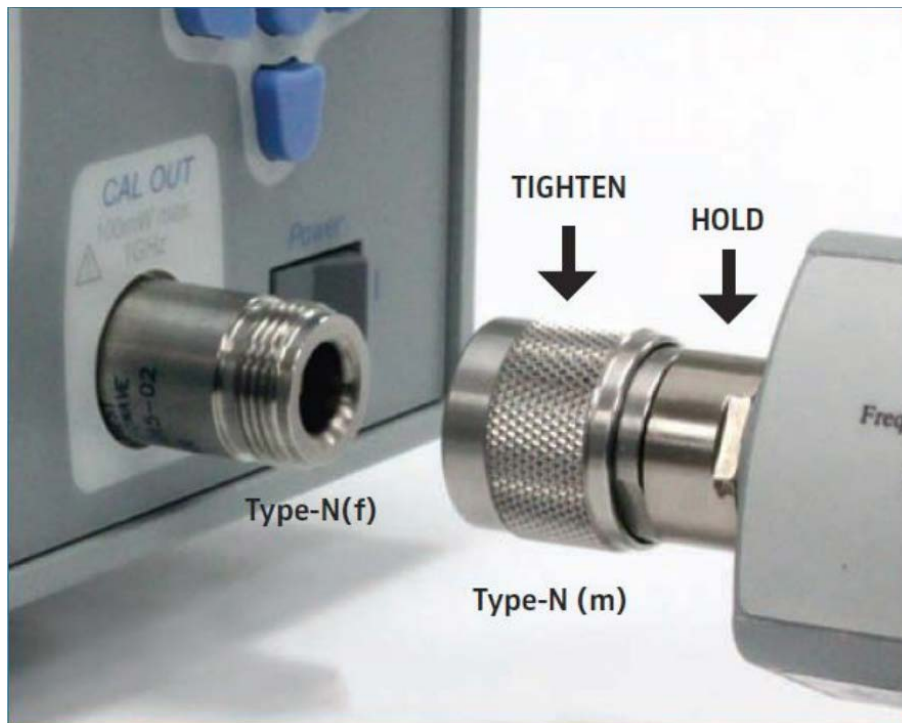

Figure 7.1 Connecting Type-N(f) to Type-N(male)

- If the connector nut is not equipped with a hex, it should be hand tightened only.
- Do not over-tighten the connector by using the sensor body for additional leverage.
- Avoid mechanical shock.
- Avoid applying excessive power.
- Observe proper ESD (electrostatic discharges) precautions

7.5 Software and Firmware Updates

The **Power Analyzer Software** includes the ability to check online for updates to both itself and the firmware in connected RFP Series Sensors.

7.5.1 Firmware Update Procedure

1. On the main menu bar select the View tab then click the **Check For Updates** button.

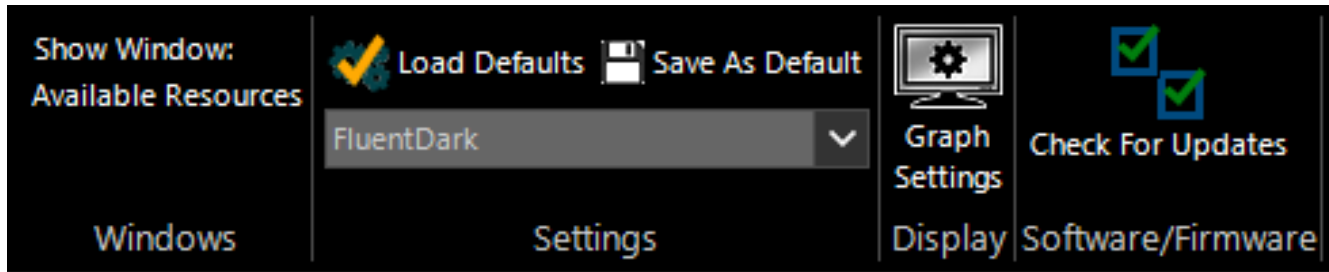

Figure 7.2 Check for Updates

2. The Software Updates pop-up will appear. In the row labeled **RFP Series ... Firmware**, click the **Launch** button.

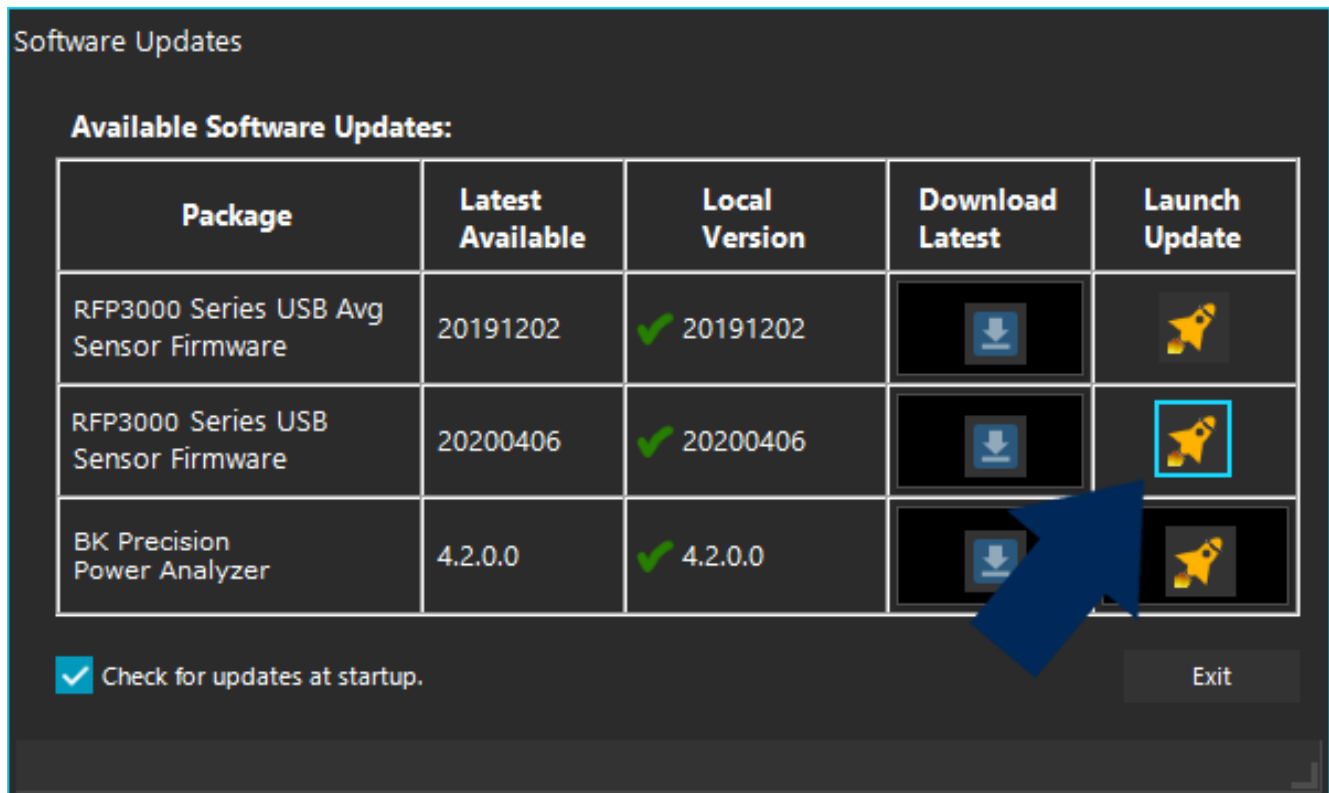

Figure 7.3 Software Updates pop-up

Note:

Firmware current with the release of the Power Analyzer Software is embedded in the program and does not have to be downloaded.

- If multiple RFP Series Sensor are connected the **Select Sensor** pop-up will appear. Select the desired sensor from the drop-down menu and click **OK**.

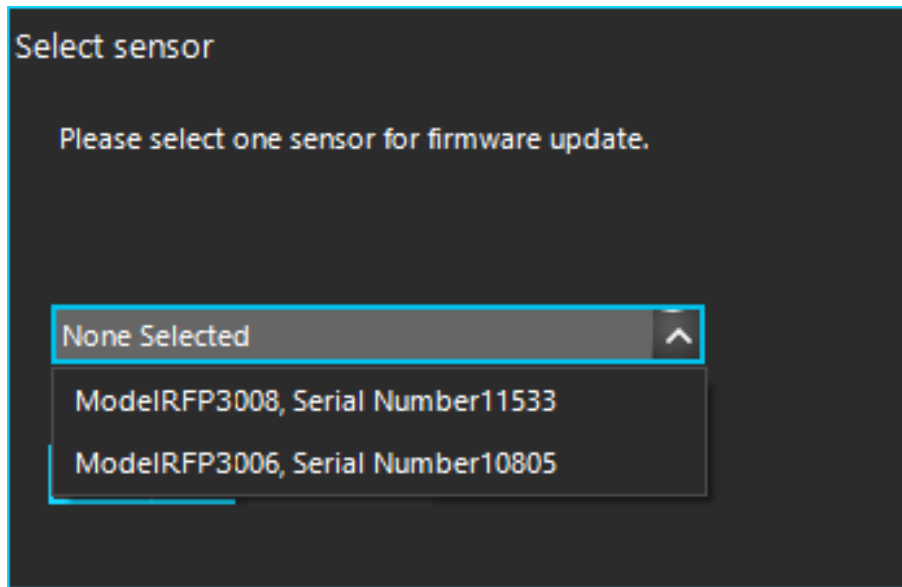

Figure 7.4 Select Sensor

- The **Firmware Update** pop-up will appear. If only one sensor is connected upon clicking the **Launch** button the **Firmware Update** pop-up will appear without having to select a sensor.

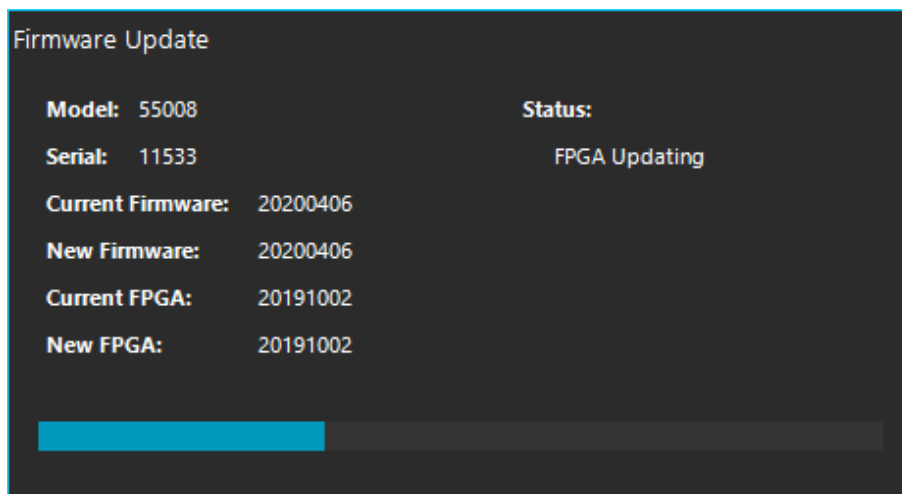

Figure 7.5 Firmware Update Progress Bar

5. Following successful firmware update, a status dialog will be displayed.

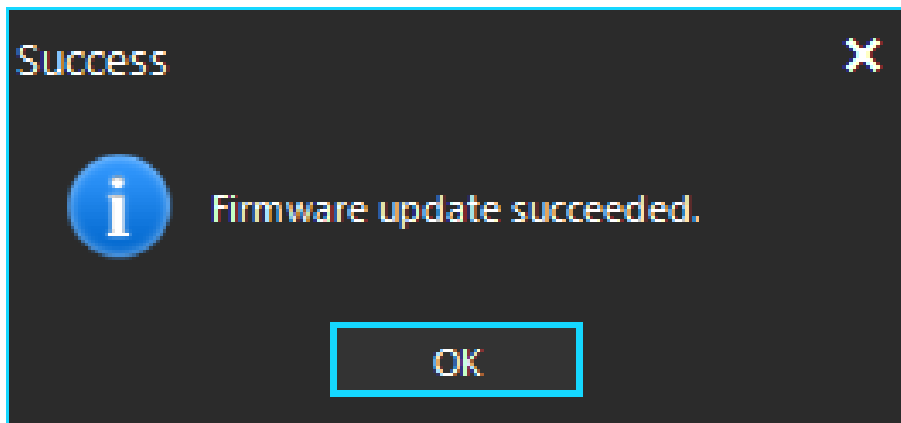

Figure 7.6 Firmware Update Succeeded

If the firmware is up to date the **Up to Date** pop-up will appear.

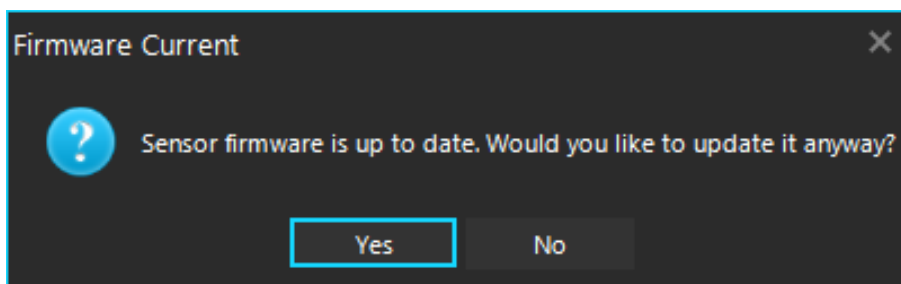

Figure 7.7 Up to Date

7.5.2 Power Analyzer Software Update Procedure

1. On the main menu bar select the View tab then click the **Check for Updates** button.
pop-up

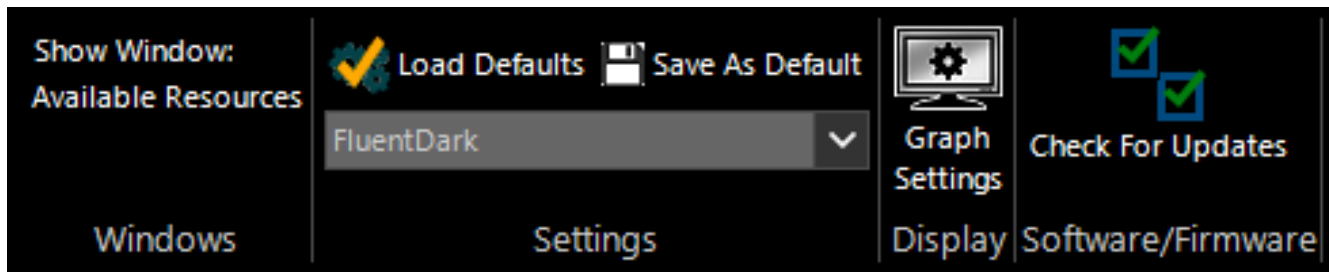

Figure 7.8 Check for Updates

2. The **Available Software Updates** pop-up will appear. In order to upgrade the software, download the update. In the row labeled **BK Precision Power Analyzer**, click the **Download** button.

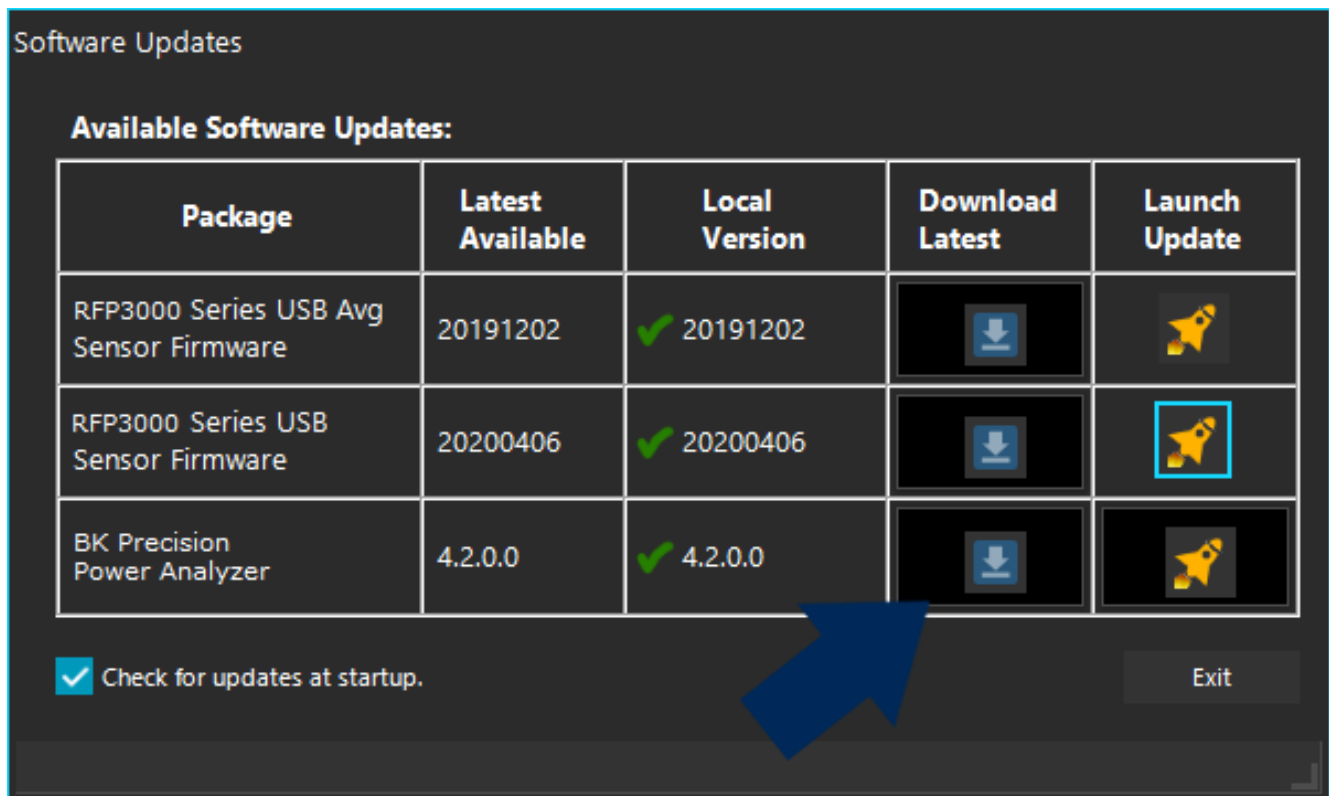

Figure 7.9 Download the Power Analyzer Software

3. A save file dialog box will appear. Choose the location you wish to save the software update.

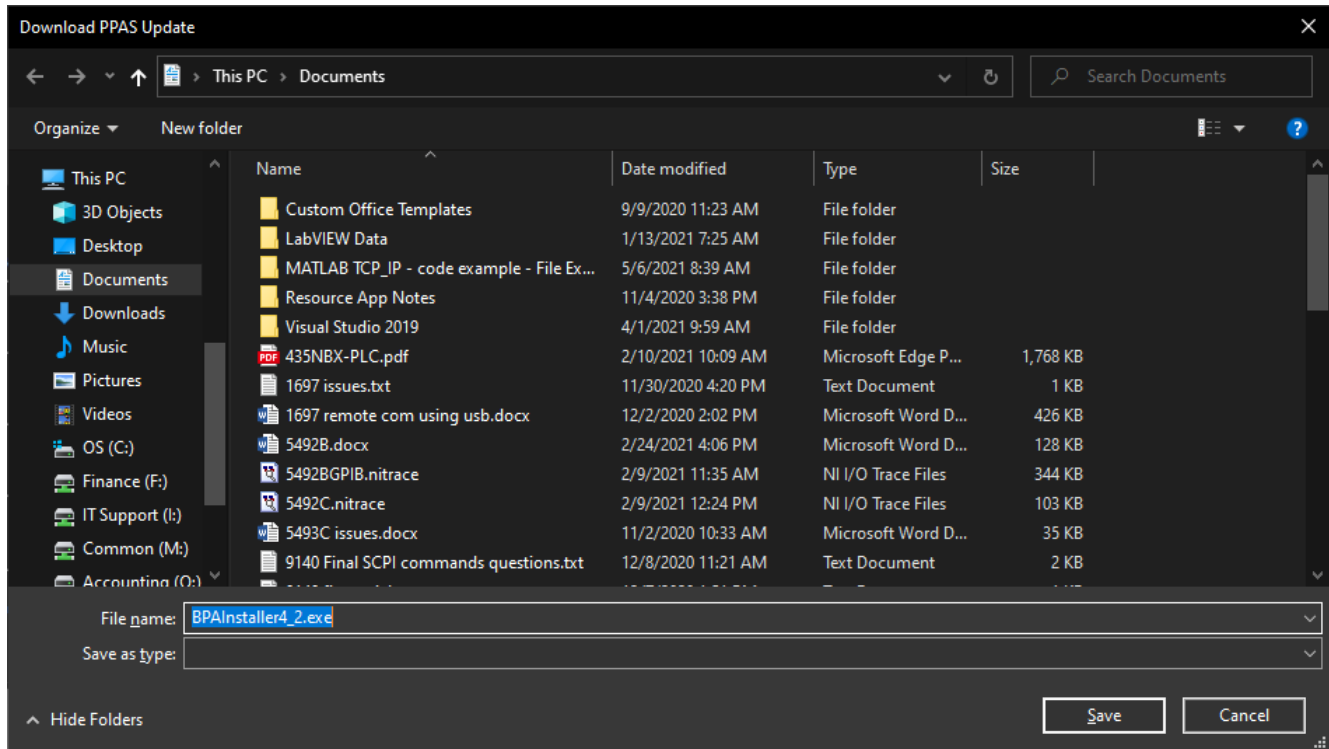

Figure 7.10 Saving the Software Update

4. The following message will appear when the download completes.

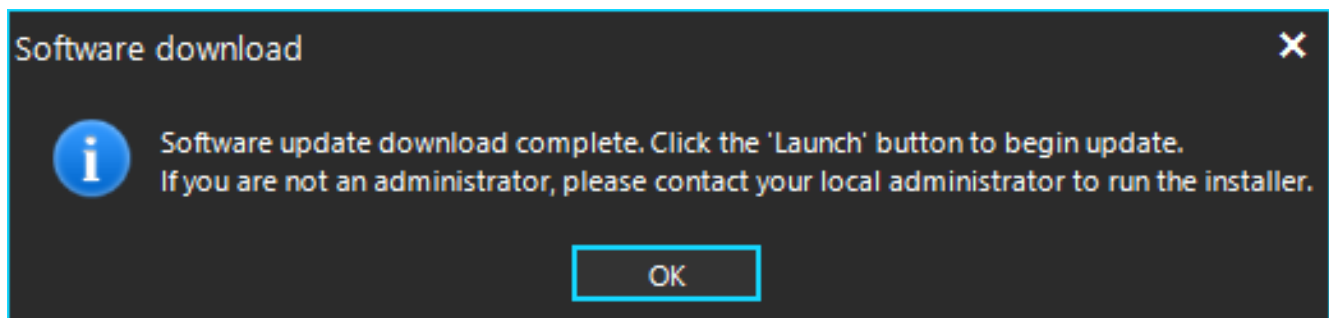

Figure 7.11 Save Complete

- Click the **Launch** button to begin the upgrade.

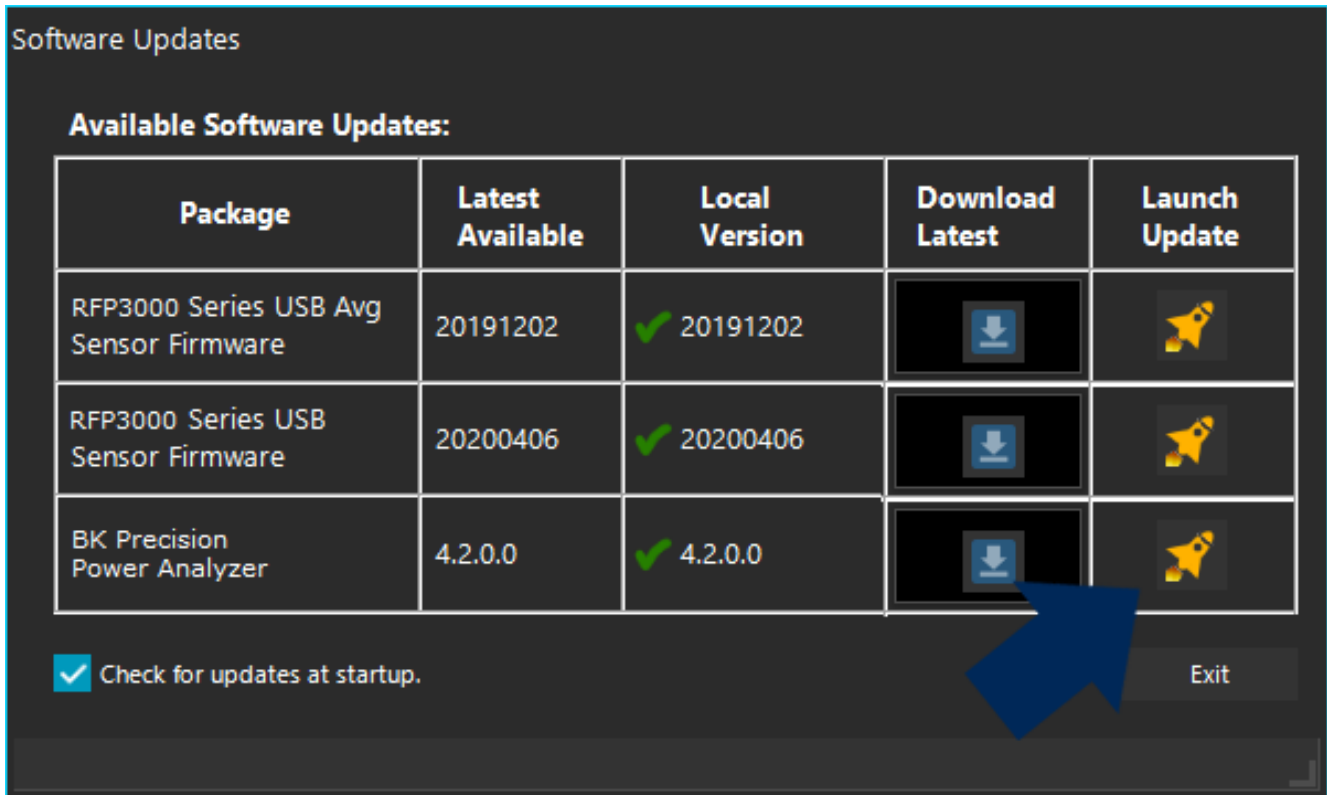

Figure 7.12 Launch the Power Analyzer Software Update

A progress bar will appear in the **Launch** column. Before the upgrade begins, the update package must be unzipped. This process will take several minutes.

The installer will begin. Follow the prompts to complete the installation.

7.5.3 Checking for New Firmwarr After the Initial Installation

When new features are added to the **Power Analyzer Software**, a sensor firmware update is sometimes required to fully support the new capabilities. After the update of the **Power Analyzer Software**, it is recommended that users check for new firmware using the following procedure.

- On the main menu bar select the View tab then click the **Check for Updates** button.

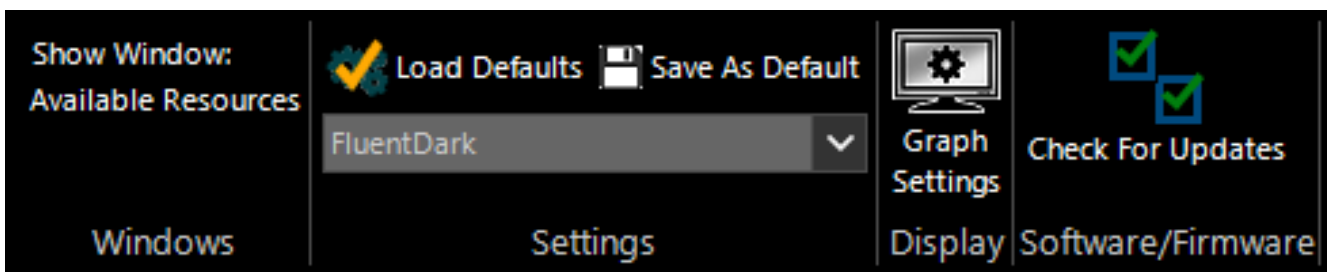

Figure 7.13 Check for Updates

2. If a new version of firmware is available, there will be a yellow triangle with an exclamation point next to the version under **Local Version**.
3. To begin downloading the newest firmware images, click the download button.

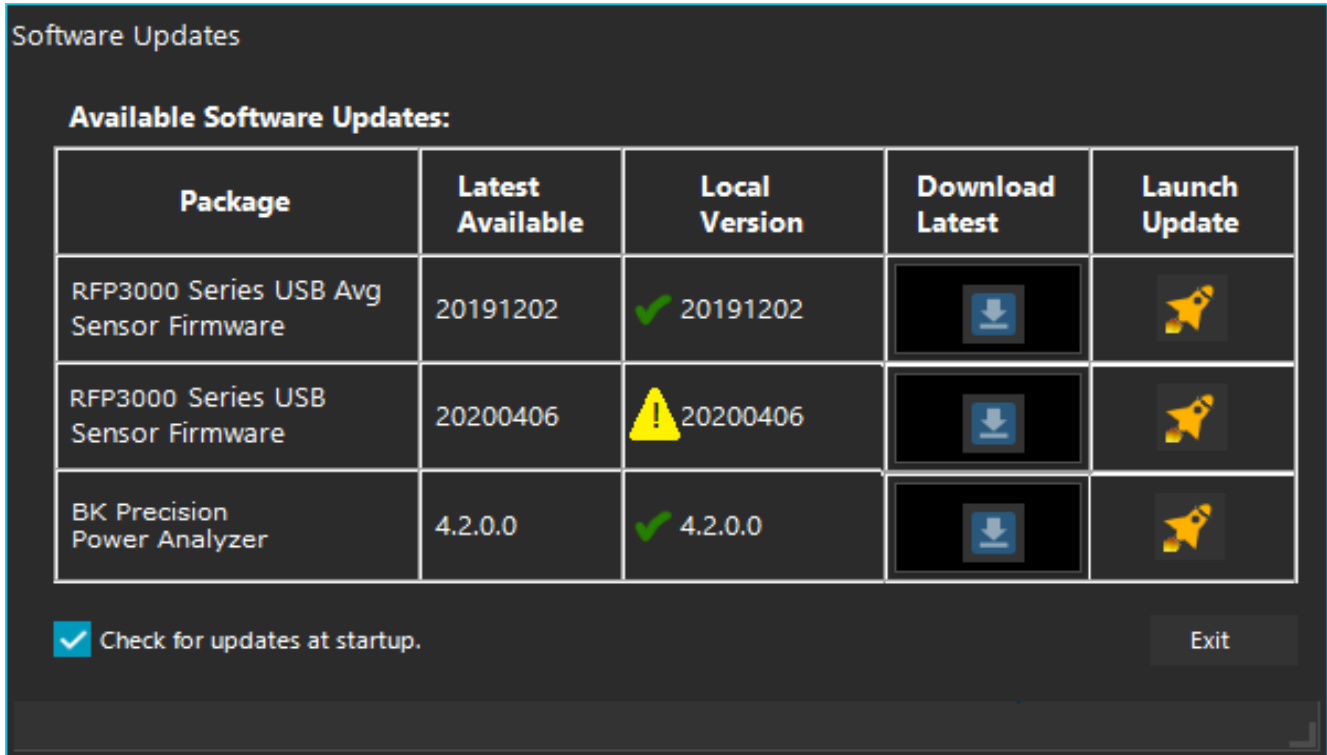







Figure 7.14 Check for Updates

A progress bar will appear in the “Download” column. This process may take several minutes.

4. Once the download is complete, a green check mark will appear next to the firmware version number.

Software Updates

Available Software Updates:

Package	Latest Available	Local Version	Download Latest	Launch Update
RFP3000 Series USB Avg Sensor Firmware	20191202	✓ 20191202		
RFP3000 Series USB Sensor Firmware	20200406	✓ 20200406		
BK Precision Power Analyzer	4.2.0.0	✓ 4.2.0.0		

Check for updates at startup. Exit

Figure 7.15 Firmware is Up to Date

Specifications

Specifications

Note: All specifications apply to the unit after a temperature stabilization time of 15 minutes over an ambient temperature range of 23 °C ± 5 °C. Specifications are valid for single unit operation only.

Sensor	RFP3006	RFP3008	RFP3018	RFP3118	RFP3040	RFP3140
RF Frequency Range	50 MHz to 6 GHz	50 MHz to 8 GHz	50 MHz to 18 GHz	50 MHz to 18 GHz	50 MHz to 40 GHz	50 MHz to 40 GHz
Dynamic Range						
Average	-60 to +20 dBm	-60 to +20 dBm ⁽¹⁾ -53 to +20 dBm ⁽²⁾	-34 to +20 dBm	-50 to +20 dBm	-34 to +20 dBm	-50 to +20 dBm
Pulse	-50 to +20 dBm	-50 to +20 dBm ⁽¹⁾ -43 to +20 dBm ⁽²⁾	-24 to +20 dBm	-40 to +20 dBm	-24 to +20 dBm	-40 to +20 dBm
Internal Trigger						
Range	-38 to +20 dBm	-38 to +20 dBm	-10 to +20 dBm	-27 to +20 dBm	-10 to +20 dBm	-27 to +20 dBm
Min Pulse Width (fast/std)	10 ns / 3 μs	10 ns / 3 μs	10 ns / 3 μs	200 ns / 3 μs	10 ns / 3 μs	200 ns / 3 μs
Max Repetition Rate	50 MHz	50 MHz	50 MHz	5 MHz	50 MHz	50 MHz
Rise Time (fast/std)	3 ns / < 10 μs	4 ns / < 10 μs	5 ns / < 10 μs	< 100 ns / < 10 μs	5 ns / < 10 μs	< 100 ns / < 10 μs
Video Bandwidth (high/std)	195 MHz / 350 kHz	165 MHz / 350 kHz	70 MHz / 350 kHz	6 MHz / 350 kHz	70 MHz / 350 kHz	6 MHz / 350 kHz
Single-shot Bandwidth	35 MHz	35 MHz	35 MHz	6 MHz	35 MHz	6 MHz
RF Input Type	Type N, 50 Ω	Type N, 50 Ω	Type N, 50 Ω	Type N, 50 Ω	2.92 mm, 50 Ω	2.92 mm, 50 Ω
VSWR	1.25 (0.05 to 6 GHz)	1.20 (0.05 to 6 GHz) 1.25 (6 GHz to 8 GHz)	1.15 (0.05 to 2.0 GHz) 1.28 (2.0 to 16 GHz) 1.34 (16 to 18 GHz)	1.15 (0.5 to 2.0 GHz) 1.20 (2.0 to 6.0 GHz) 1.28 (6.0 to 16 GHz) 1.34 (16 to 18 GHz)	1.25 (0.05 to 4.0 GHz) 1.65 (4.0 to 38 GHz) 2.00 (38 to 40 GHz)	1.25 (0.05 to 4.0 GHz) 1.65 (4.0 to 38 GHz) 2.00 (38 to 40 GHz)

⁽¹⁾ From 50 MHz to 6 GHz

⁽²⁾ From >6 GHz to 8 GHz

RFP3000 Series		
Series Specifications		
Sampling Techniques	Real-time / Equivalent Time / Statistical Sampling	
Continuous Sample Rate	100 MHz	
Effective Sample Rate	10 GHz	
Time Base		
Time Base Range	5 ns / div to 50 ms / div (pulse mode)	
Time Base Accuracy	± 25 ppm	
Time Base Resolution	100 ps (RIS mode)	
	10 ns (single-sweep)	
Trigger		
Trigger Sources	Internal (applied RF), External TTL, Crossover (from another sensor)	
Trigger Modes	Single, Normal, AutoTrig, AutoLevel, Free Run	
Trigger Slope	Positive or negative	
Trigger Delay	Range	± 1.0 s (timebase dependent)
	Resolution	0.02 divisions
Trigger Holdoff (arming control)	Modes	Off, Holdoff, Gap (frame) arming
	Range	10 ns to 1000 ms
	Resolution	10 ns

Trigger		
Trigger Jitter	≤ 0.1 ns rms	
Trigger Latency	< 10 ns	
External Trigger	Logic Thresholds High	> 2.4 V, Low: < 0.7 V
	Maximum Input Range	-0.1 V to 5.1 V
	Input Impedance	10 kΩ
	Minimum Pulse Width	10 ns
	Maximum Repetition Rate	50 MHz
Speed		
Trace Acquisition Speed	> 100,000 triggered sweeps / s	
Measurement Speed over USB	Triggered or Free-run	100,000 readings / s (buffered mode)
	Continuous Query/Response	1000 measurements / s
Interface		
Connectivity	Data Interface	USB 2.0 Hi-Speed
	Device Type	USB High-Power device, bus powered
	Current Draw	500 mA max (480 mA typical)
	Connector	Type B, locking

Specifications (cont.)

Interface		
Multi-I/O	Connector Type	SMB female
	Input Modes	Ext Trig, Crossover Slave, Analog
	Output Modes T	Timebase ref, Sweep, Trig Threshold, Crossover Master, Status
Software Interface	Application Programming Interface	Windows DLL
	Graphical User Interface	Power Analyzer™ software
	Supported Operating Systems	Windows 7 (32-bit and 64-bit) Windows 8 (32-bit and 64-bit) Windows 10
System Hardware Requirements	Processor	1.3 GHz or higher recommended
	RAM	512 MB (1 GB or more recommended)
	Hard Disk Space	Min 1.0 GB free space to install or run
	Display Resolution	800 x 600 (1280 x 1024 or higher recommended)

Power Analyzer™ Software		
Display Types	Graph (power vs time) - Numeric (numeric data) Statistical Measurements - CCDF	
	Automatic measurements (pulse / multiple pulse analysis, marker measurements)	
Marker Measurements (in Graph View)	Markers (vertical cursors)	Settable in time relative to the trigger position
	Marker Independently	Power at specified time
	Pair of Markers	Min and max power between markers and ratio or average power between them.
	Ref Lines (horizontal cursors)	Settable in power
	Automatic Tracking	Intersection of either marker and the waveform. Either marker and pulse distal, mesial or proximal levels.
Pulse Mode Automatic Measurements	Pulse width - Pulse period - Pulse rise-time - Pulse fall-time Pulse repetition frequency - Pulse duty cycle - Pulse off-time Waveform average - Pulse average - Pulse peak - Pulse overshoot Pulse droop - Top level power - Bottom level power - Edge delay Pulse edge skew between channel	
Statistical Mode Automatic Measurements	Peak power - Average power - Minimum power - Peak to average ratio Dynamic range - Percent at reference line - Crest factor at markers Crest factor at various probabilities	

Operational Requirements	
Tests performed per MIL-28800F (Class 3)	
Operating Temperature	0 C to 55 °C
Storage Temperature	-40 C to +70 °C
Relative Humidity (non-condensing)	< 45 % at 50 °C < 75 % at 40 °C < 95 % at 30 °C
Altitude	3048 m max
Shock	30 g half-sine, 11 ms duration
Vibration	Sinusoidal: 5 Hz to 55 Hz, 3 g max
	Random: 10 Hz to 500 Hz, 2.34 g rms
	Power Spectral Density: 0.01 g ² / Hz
Regulatory Compliance	
Class A Equipment	
European Union	EMC Directive 2014/30/EU, EN 61326:2013, EN 55011:2019, Low Voltage Directive 2014/35/EU, EN 61010-1:2001, and RoHS Directive 2015/863/EU
Australia and New Zealand	RCM AS/NZS 4417:2012
General	
Power Consumption	2.5 W max (USB High-Power device)
Dimensions (H x W x D)	1.7" x 1.7" x 5.7" (4.3 cm x 4.3 cm x 14.5 cm)
Weight	0.8 lbs (0.36 kg)
Warranty	3 years
Standard Accessories	1.8 m USB A (m) to USB B (m) locking SeaLATCH cable, power cord, test report & certificate of calibration

Service Information

Warranty Service: Please go to the support and service section on our website at bkprecision.com to obtain an RMA #. Return the product in the original packaging with proof of purchase to the address below. Clearly state on the RMA the performance problem and return any leads, probes, connectors and accessories that you are using with the device.

Non-Warranty Service: Please go to the support and service section on our website at bkprecision.com to obtain an RMA #. Return the product in the original packaging to the address below. Clearly state on the RMA the performance problem and return any leads, probes, connectors and accessories that you are using with the device. Customers not on an open account must include payment in the form of a money order or credit card. For the most current repair charges please refer to the service and support section on our website.

Return all merchandise to B&K Precision Corp. with prepaid shipping. The flat-rate repair charge for Non-Warranty Service does not include return shipping. Return shipping to locations in North America is included for Warranty Service. For overnight shipments and non-North American shipping fees please contact B&K Precision Corp.

Include with the returned instrument your complete return shipping address, contact name, phone number and description of problem.

B&K Precision Corp.
22820 Savi Ranch Parkway
Yorba Linda, CA 92887
bkprecision.com
714-921-9095

LIMITED THREE-YEAR WARRANTY

B&K Precision Corp. warrants to the original purchaser that its products and the component parts thereof, will be free from defects in workmanship and materials for a period of **three years** from date of purchase.

B&K Precision Corp. will, without charge, repair or replace, at its option, defective product or component parts. Returned product must be accompanied by proof of the purchase date in the form of a sales receipt.

To help us better serve you, please complete the warranty registration for your new instrument via our website www.bk-precision.com

Exclusions: This warranty does not apply in the event of misuse or abuse of the product or as a result of unauthorized alterations or repairs. The warranty is void if the serial number is altered, defaced or removed.

B&K Precision Corp. shall not be liable for any consequential damages, including without limitation damages resulting from loss of use. Some states do not allow limitations of incidental or consequential damages. So the above limitation or exclusion may not apply to you.

This warranty gives you specific rights and you may have other rights, which vary from state-to-state.

B&K Precision Corp.
22820 Savi Ranch Parkway
Yorba Linda, CA 92887
www.bkprecision.com
714-921-9095