

User Manual

2560B Series

Digital Storage and Mixed Signal Oscilloscopes



Safety Summary

The following safety precautions apply to both operating and maintenance personnel and must be followed during all phases of operation, service, and repair of this instrument.

WARNING

Before applying power to this instrument:

- Read and understand the safety and operational information in this manual.
- Apply all the listed safety precautions.
- Verify that the voltage selector at the line power cord input is set to the correct line voltage. Operating the instrument at an incorrect line voltage will void the warranty.
- Make all connections to the instrument before applying power.
- Do not operate the instrument in ways not specified by this manual or by B&K Precision.

Failure to comply with these precautions or with warnings elsewhere in this manual violates the safety standards of design, manufacture, and intended use of the instrument. B&K Precision assumes no liability for a customer's failure to comply with these requirements.

Category rating

The IEC 61010 standard defines safety category ratings that specify the amount of electrical energy available and the voltage impulses that may occur on electrical conductors associated with these category ratings. The category rating is a Roman numeral of I, II, III, or IV. This rating is also accompanied by a maximum voltage of the circuit to be tested, which defines the voltage impulses expected and required insulation clearances. These categories are:

Category I (CAT I): Measurement instruments whose measurement inputs are not intended to be connected to the mains supply. The voltages in the environment are typically derived from a limited-energy transformer or a battery.

Category II (CAT II): Measurement instruments whose measurement inputs are meant to be connected to the mains supply at a standard wall outlet or similar sources. Example measurement environments are portable tools and household appliances.

Category III (CAT III): Measurement instruments whose measurement inputs are meant to be connected to the mains installation of a building. Examples are measurements inside a building's circuit breaker panel or the wiring of permanently-installed motors.

Category IV (CAT IV): Measurement instruments whose measurement inputs are meant to be connected to the primary power entering a building or other outdoor wiring.

WARNING

Do not use this instrument in an electrical environment with a higher category rating than what is specified in this manual for this instrument.

WARNING

You must ensure that each accessory you use with this instrument has a category rating equal to or higher than the instrument's category rating to maintain the instrument's category rating. Failure to do so will lower the category rating of the measuring system.

Electrical Power

This instrument is intended to be powered from a CATEGORY II mains power environment. The mains power should be 115 V RMS or 230 V RMS. Use only the power cord supplied with the instrument and ensure it is appropriate for your country of use.

Ground the Instrument

WARNING

To minimize shock hazard, the instrument chassis and cabinet must be connected to an electrical safety ground. This instrument is grounded through the ground conductor of the supplied, three-conductor AC line power cable. The power cable must be plugged into an approved three-conductor electrical outlet. The power jack and mating plug of the power cable meet IEC safety standards.

WARNING

Do not alter or defeat the ground connection. Without the safety ground connection, all accessible conductive parts (including control knobs) may provide an electric shock. Failure to use a properly-grounded approved outlet and the recommended three-conductor AC line power cable may result in injury or death.

WARNING

Unless otherwise stated, a ground connection on the instrument's front or rear panel is for a reference of potential only and is not to be used as a safety ground. Do not operate in an explosive or flammable atmosphere.

WARNING

Do not operate the instrument in the presence of flammable gases or vapors, fumes, or finely-divided particulates.

WARNING

The instrument is designed to be used in office-type indoor environments. Do not operate the instrument

- In the presence of noxious, corrosive, or flammable fumes, gases, vapors, chemicals, or finely-divided particulates.
- In relative humidity conditions outside the instrument's specifications.
- In environments where there is a danger of any liquid being spilled on the instrument or where any liquid can condense on the instrument.
- In air temperatures exceeding the specified operating temperatures.
- In atmospheric pressures outside the specified altitude limits or where the surrounding gas is not air.
- In environments with restricted cooling air flow, even if the air temperatures are within specifications.
- In direct sunlight.

This instrument is intended to be used in an indoor pollution degree 2 environment. The operating temperature range is 0°C to 40°C and 20% to 80% relative humidity, with no condensation allowed. Measurements made by this instrument may be outside specifications if the instrument is used in non-office-type environments. Such environments may include rapid temperature or humidity changes, sunlight, vibration and/or mechanical shocks, acoustic noise, electrical noise, strong electric fields, or strong magnetic fields.

Do not operate instrument if damaged

⚠ WARNING

If the instrument is damaged, appears to be damaged, or if any liquid, chemical, or other material gets on or inside the instrument, remove the instrument's power cord, remove the instrument from service, label it as not to be operated, and return the instrument to B&K Precision for repair. Notify B&K Precision of the nature of any contamination of the instrument.

Clean the instrument only as instructed

⚠ WARNING

Do not clean the instrument, its switches, or its terminals with contact cleaners, abrasives, lubricants, solvents, acids/bases, or other such chemicals. Clean the instrument only with a clean dry lint-free cloth or as instructed in this manual. Not for critical applications

⚠ WARNING

This instrument is not authorized for use in contact with the human body or for use as a component in a life-support device or system.

Do not touch live circuits

⚠ WARNING

Instrument covers must not be removed by operating personnel. Component replacement and internal adjustments must be made by qualified service-trained maintenance personnel who are aware of the hazards involved when the instrument's covers and shields are removed. Under certain conditions, even with the power cord removed, dangerous voltages may exist when the covers are removed. To avoid injuries, always disconnect the power cord from the instrument, disconnect all other connections (for example, test leads, computer interface cables, etc.), discharge all circuits, and verify there are no hazardous voltages present on any conductors by measurements with a properly-operating voltage-sensing device before touching any internal parts. Verify the voltage-sensing device is working properly before and after making the measurements by testing with known-operating voltage sources and test for both DC and AC voltages. Do not attempt any service or adjustment unless another person capable of rendering first aid and resuscitation is present.

Do not insert any object into an instrument's ventilation openings or other openings.

⚠ WARNING

Hazardous voltages may be present in unexpected locations in circuitry being tested when a fault condition in the circuit exists.

⚠ WARNING

Fuse replacement must be done by qualified service-trained maintenance personnel who are aware of the instrument's fuse requirements and safe replacement procedures. Disconnect the instrument from the power line before replacing fuses. Replace fuses only with new fuses of the fuse types, voltage ratings, and current ratings specified in this manual or on the back of the instrument. Failure to do so may damage the instrument, lead to a safety hazard, or cause a fire. Failure to use the specified fuses will void the warranty.

Servicing



Do not substitute parts that are not approved by B&K Precision or modify this instrument. Return the instrument to B&K Precision for service and repair to ensure that safety and performance features are maintained.

For continued safe use of the instrument

- Do not place heavy objects on the instrument.
- Do not obstruct cooling air flow to the instrument.
- Do not place a hot soldering iron on the instrument.
- Do not pull the instrument with the power cord, connected probe, or connected test lead.
- Do not move the instrument when a probe is connected to a circuit being tested.

Working Environment

Environment

This instrument is intended for indoor use and should be operated in a clean, dry environment.

Temperature

Operating: 0°C to +40°C

Non-operation: -20°C to +60°C

Note:

Direct sunlight, radiators, and other heat sources should be taken into account when assessing the ambient temperature.

Humidity

Operating: 85% RH, 40 °C, 24 hours

Non-operating: 85% RH, 65 °C, 24 hours

Altitude

Operating: less than 3 Km

Non-operation: less than 15 Km

Installation (overvoltage) Category

This product is powered by mains conforming to installation (overvoltage) category II.

Degree of Pollution

The oscilloscopes may be operated in environments of Pollution Degree II.

Note:

Degree of Pollution II refers to a working environment which is dry and non-conductive pollution occurs. Occasional temporary conductivity caused by condensation is expected.

IP Rating

IP20 (as defined in IEC 60529).

Compliance Statements

Disposal of Old Electrical & Electronic Equipment (Applicable in the European Union and other European countries with separate collection systems)

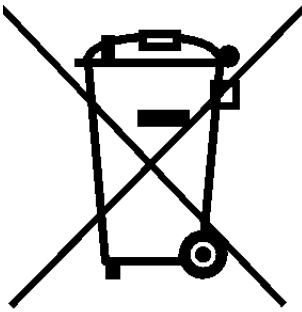

This product is subject to Directive 2002/96/EC of the European Parliament and the Council of the European Union on waste electrical and electronic equipment (WEEE), and in jurisdictions adopting that Directive, is marked as being put on the market after August 13, 2005, and should not be disposed of as unsorted municipal waste. Please utilize your local WEEE collection facilities in the disposition of this product and otherwise observe all applicable requirements.



Safety Symbols

Symbol	Description
	indicates a hazardous situation which, if not avoided, will result in death or serious injury.
	indicates a hazardous situation which, if not avoided, could result in death or serious injury
	indicates a hazardous situation which, if not avoided, will result in minor or moderate injury
	Refer to the text near the symbol.
	Electric Shock hazard
	Alternating current (AC)
	Chassis ground
	Earth ground
	This is the In position of the power switch when instrument is ON.
	This is the Out position of the power switch when instrument is OFF.
	is used to address practices not related to physical injury.

Contents

1	General Information	13
1.1	Product Overview	13
1.2	Features	14
1.3	Contents	15
1.4	Dimensions	15
1.5	Front Panel Overview	16
1.6	Rear Panel Overview	17
1.7	Touch Screen Overview	18
2	Getting Started	19
2.1	Input Power Requirements	19
2.2	Fuse Requirements and Replacement	20
2.3	Preliminary Check	21
2.3.1	Verify AC Input Voltage	21
2.3.2	Connect Power	21
2.3.3	Self-Test	21
2.3.4	Self-Cal	21
2.3.5	Check Model and Firmware Version	21
2.3.6	Function Check	22
2.4	Probe Safety	23
3	Control Panel	25
3.1	Vertical Control	25
3.2	Horizontal Control	26
3.3	Trigger Control	26
3.4	Run/Stop Key	27
3.5	Auto Setup Key	27
3.6	Analysis Keys	27
3.7	Universal Knob	28
3.8	Menu Keys	28
3.9	Other Keys	29
4	Acquisition	30
4.1	Changing Acquisition Mode	30
4.2	Sequence	32
5	History	33
6	Horizontal Control	34
6.1	Adjusting the Horizontal Scale (time/div)	34
6.2	Adjusting the Horizontal Delay (position)	35
6.3	Panning and Zooming Single or Stopped Acquisitions	36
6.4	Horizontal Scale (Coarse/Fine)	36
6.5	Zoom	37
6.6	Roll	38

7	Vertical Control	39
7.1	Enabling Channels	39
7.1.1	Channel Enable/Disable From the Touch Screen	39
7.2	Vertical Scale	40
7.2.1	Coarse/Fine Adjustment	40
7.3	Vertical Position	40
7.4	Channel Setup	41
7.4.1	Channel Coupling	41
7.4.2	Bandwidth Limit	42
7.4.3	Probe Attenuation	42
7.4.4	Label	43
7.4.5	Apply To	43
7.4.6	Impedance	44
7.4.7	Unit	44
7.4.8	Deskew	44
7.4.9	Invert	45
7.4.10	Trace	45
8	Digital Channels	46
8.1	LP2560 Probe	46
8.2	Connecting the Digital Probes	47
8.3	Acquiring Digital Waveforms	47
8.4	Displaying Digital Channels	48
8.5	Turning Individual Channels On or Off	49
8.6	Logic Threshold for Digital Channels	50
8.7	Displaying Digital Channels as a Bus	50
9	Trigger	52
9.1	Trigger Source	53
9.2	Trigger Types	54
9.2.1	Edge Trigger	54
9.2.2	Slope Trigger	55
9.2.3	Pulse Trigger	57
9.2.4	Video Trigger	59
9.2.5	Window Trigger	62
9.2.6	Interval Trigger	64
9.2.7	Dropout Trigger	65
9.2.8	Runt Trigger	67
9.2.9	Pattern Trigger	68
9.3	Trigger Mode	70
9.4	Trigger Level	71
9.5	Trigger Coupling	72
9.6	Trigger Holdoff	73
9.6.1	Holdoff by Time	73
9.6.2	Holdoff by Event	73
9.6.3	Start Holdoff On	74
9.7	Noise Reject	75
9.8	Zone Trigger	76
9.8.1	Creating and Moving Zones	76
10	Serial Trigger and Decode	79
10.1	I2C Trigger and Serial Decode	79
10.1.1	Setup for I2C Signals	79
10.1.2	I2C Trigger	81
10.1.3	I2C Serial Decode	84
10.2	SPI Trigger and Serial Decode	85
10.2.1	Setup for SPI Signals	85
10.2.2	SPI Trigger	88

	9
10.2.3 SPI Serial Decode	89
10.3 UART Trigger and Serial Decode	90
10.3.1 Setup for UART Signals	90
10.3.2 UART Trigger	91
10.3.3 UART Serial Decode	92
10.4 CAN Trigger and Serial Decode	94
10.4.1 Setup for CAN Signals	94
10.4.2 CAN Trigger	94
10.4.1 CAN Serial Decode	95
10.5 LIN Trigger and Serial Decode	97
10.5.1 Setup for LIN Signals	97
10.5.2 LIN Trigger	97
10.5.1 Interpreting LIN Decode	99
10.6 FlexRay Trigger and Serial Decode	100
10.6.1 FlexRay Signal Configuration	100
10.6.2 FlexRay Trigger	101
10.6.3 FlexRay Serial Decode	102
10.7 CAN FD Trigger and Serial Decode	104
10.7.1 CAN FD Signal Configuration	104
10.7.2 CAN FD Trigger	106
10.7.3 CAN FD Serial Decode	106
10.8 I2S Trigger and Serial Decode	108
10.8.1 I2S Signal Configuration	108
10.8.2 I2S Trigger	111
10.8.3 I2S Serial Decode	112
10.9 MIL-STD-1553B Trigger and Serial Decode	113
10.9.1 MIL-STD-1553B Signal Configuration	113
10.9.2 MIL-STD-1553B Serial Decode	114
10.10 SENT Trigger and Serial Decode	116
10.10.1 SENT Signal Configuration	116
10.10.2 SENT Trigger	118
10.10.3 SENT Serial Decode	121
10.11 Manchester Trigger and Serial Decode	124
10.11.1 Manchester Signal Configuration	124
10.11.2 Manchester Serial Decode	126
11 Cursors	128
11.1 X Cursors	129
11.2 Y Cursors	130
11.3 Display Style	132
11.4 Make Cursor Measurements	133
11.5 Cursors Reference	134
12 Measure	136
12.1 Measurement Modes	136
12.2 Set Measurement Types	138
12.3 Type of Measurement	139
12.3.1 Vertical Measurements	139
12.3.2 Horizontal Measurements	141
12.3.3 Miscellaneous Measurements	142
12.3.4 Delay Measurements	143
12.4 Trend	144
12.5 Simple Measurements	145
12.6 Measurement Statistics	145
12.7 Statistics Histogram	146
12.8 Gate	146
12.9 Amplitude Strategy	147
12.10 Threshold	148

	10
13 Math	149
13.1 Units for Math Waveforms	150
13.2 Arithmetic	151
13.2.1 Subtraction Example	151
13.2.2 Average	152
13.2.3 ERES	153
13.3 Algebra	154
13.3.1 Differentiate	154
13.3.2 Integrate	155
13.3.3 Square Root	156
13.3.4 Absolute	157
13.3.5 Sign	157
13.3.6 Exp/Exp10	158
13.3.7 Ln/Lg	159
13.3.8 Interpolate	159
13.4 Frequency Analysis (FFT Operation)	160
13.4.1 Setting FFT Parameters	160
13.4.2 Parameter Display Area	162
13.4.3 Vertical	162
13.4.4 Horizontal	163
13.5 FFT Tools	163
13.5.1 Peaks Tool	163
13.5.2 Markers Tool	164
13.5.3 Measure the FFT Waveform	165
13.6 Formula Editor	166
14 Reference Waveform	167
14.1 Save REF Waveform to Internal Memory	167
14.2 Display REF Waveforms	167
15 Search	169
15.1 Setting	169
15.2 Copy	169
15.3 Results	169
16 Navigate	171
16.1 Navigate by Time	171
16.2 Navigate by Search Event	172
16.3 Navigate by History Frame	173
17 Mask Test	174
17.1 Mask Setup	175
17.1.1 Create Mask	175
17.1.2 Mask Editor	176
17.2 Operation	178
17.3 Pass/Fail Rule	178
18 Counter	179
18.1 Counter Configuration	179
18.2 Mode	180
19 Power Analysis	181
19.1 Power Quality	182
19.1.1 Type	182
19.1.2 Input Setup	183
19.2 Current Harmonics	184
19.2.1 Configuration	184
19.2.2 Standard	184
19.2.3 Parameter Description	185

19.2.4	Input Setup	185
19.3	Inrush Current	186
19.3.1	Input Setup	186
19.4	Switching Loss	187
19.4.1	Deskew Calibration	187
19.4.2	Switching Loss Configuration	188
19.4.3	Conduction Type	188
19.4.4	Input Setup	189
19.5	Slew Rate	190
19.5.1	Connection Guide	190
19.6	Modulation	191
19.6.1	Input Modulation	191
19.7	Output Ripple	192
19.7.1	Output Ripple Input Setup	192
19.8	Turn on/Turn Off	193
19.8.1	Turn On/Turn Off Input Setup	193
19.8.2	Testing Conditions	194
19.9	Transient Response	195
19.9.1	Transient Response Input Setup	195
19.9.2	Transient Response Configuration	196
19.10	PSRR	197
19.10.1	PSRR Configuration	197
19.10.2	PSRR Amplitude	197
19.11	Power Efficiency	198
19.11.1	Power Efficiency Input Setup	198
20	Bode Plot	199
20.1	Bode Plot Configuration	200
20.1.1	Connection	200
20.1.2	Sweep	201
20.1.3	Simple Sweep	201
20.1.4	Editor	203
21	Arbitrary Waveform Generator	204
21.1	AWG Configuration	204
21.1.1	Other Settings	205
22	Save/Recall	206
22.1	Save Type	206
22.2	Internal/External Save and Recall	207
22.3	File Manager	209
23	Utility Menu	211
23.1	System Setting	211
23.1.1	View System Status	211
23.1.2	Sound	211
23.2	Language	211
23.3	Screen Saver	212
23.4	IO Set	212
23.4.1	LAN	212
23.4.2	USB Device	213
23.4.3	Date/Time	213
23.5	Options	214
23.6	Reference Position	214
23.7	Do Self-Test	215
23.7.1	Screen Test	215
23.7.2	Keyboard Test	216
23.7.3	LED Test	217

23.8	Start Self Cal	218
23.9	Power On Line	218
24	Remote Control	219
24.1	Web Browser	219
24.2	Other Connectivity	220
25	Troubleshooting	221
26	Service Information	223
27	LIMITED THREE-YEAR WARRANTY	224

General Information

1.1 Product Overview



Figure 1.1 2560B

The 2560B Digital Storage (DSO) and Mixed Signal Oscilloscope (MSO) Series delivers advanced features and debug capabilities for a wide range of applications. With increasing bandwidths to 350 MHz in a 4-channel configuration, each model offers a maximum sample rate of 2 GSa/s and a maximum memory depth of 200 Mpts. Equipped with a 10.1" (1024 x 600) capacitive touchscreen and high waveform update rate of 120,000 wfms/s, these oscilloscopes can capture infrequent glitches with excellent signal fidelity.

1.2 Features

- 4 Analog channels
- Maximum sampling rate of 2 GSa/s
- 200 Mpts. memory depth
- Maximum waveform update rates of 120,000 (normal mode) and 500,000 (sequence mode)
- History and sequence mode store a maximum of 90,000 frames
- Large 10.1" TFT-LCD capacitive touchscreen, 1024 x 600 resolution
- 10-bit mode increases vertical resolution
- Advance triggers with trigger zone support
- 50 MHz DDS waveform generator supports Bode plots
- Power analysis includes 11 analyzing tools
- Automatic measurements with statistics and histogram
- Math function supports 2 traces and a formula editor
- 2 Mpts FFT provides high resolution of frequency spectrum
- Additional 16 digital channels standard in MSO models (option available for DSO)
- Serial bus decoder supports I2C, SPI, UART, CAN and LIN protocol
- LAN and USBTMC-compliant USB device port for remote PC control
- USB Host (x2), Pass/Fail Out and EXT Trig
- Support SCPI remote control commands

1.3 Contents

- 1 x 2560B Digital Storage Oscilloscope (DSO) or Mixed Signal Oscilloscope (MSO)
- AC Power Cord
- USB type A to type B cable.
- Certificate of Calibration
- Test Report
- 4 oscilloscope probes

Model	2565B	2565B-MSO	2567B	2567B-MSO	2569B	2569B-MSO
Probe	PR150B		PR250B		PR500B	
Bandwidth	150 MHz		250 MHz		500 MHz	
Attenuation Value	X1, X10		X10		X10	

Table 1.1 Probes

- 1 x LP2560 (MSO models)

Note:

Ensure the presence of all the items above. Contact the distributor if any items are missing.

1.4 Dimensions

The 2560B series oscilloscope’s dimensions are approximately: 352 mm (13.9 in) x 224.00 mm (8.8 in) x 101 mm (4 in) (W x H x D).



Figure 1.2 Front View Dimension

1.5 Front Panel Overview

The front panel interface allows for control of the unit.

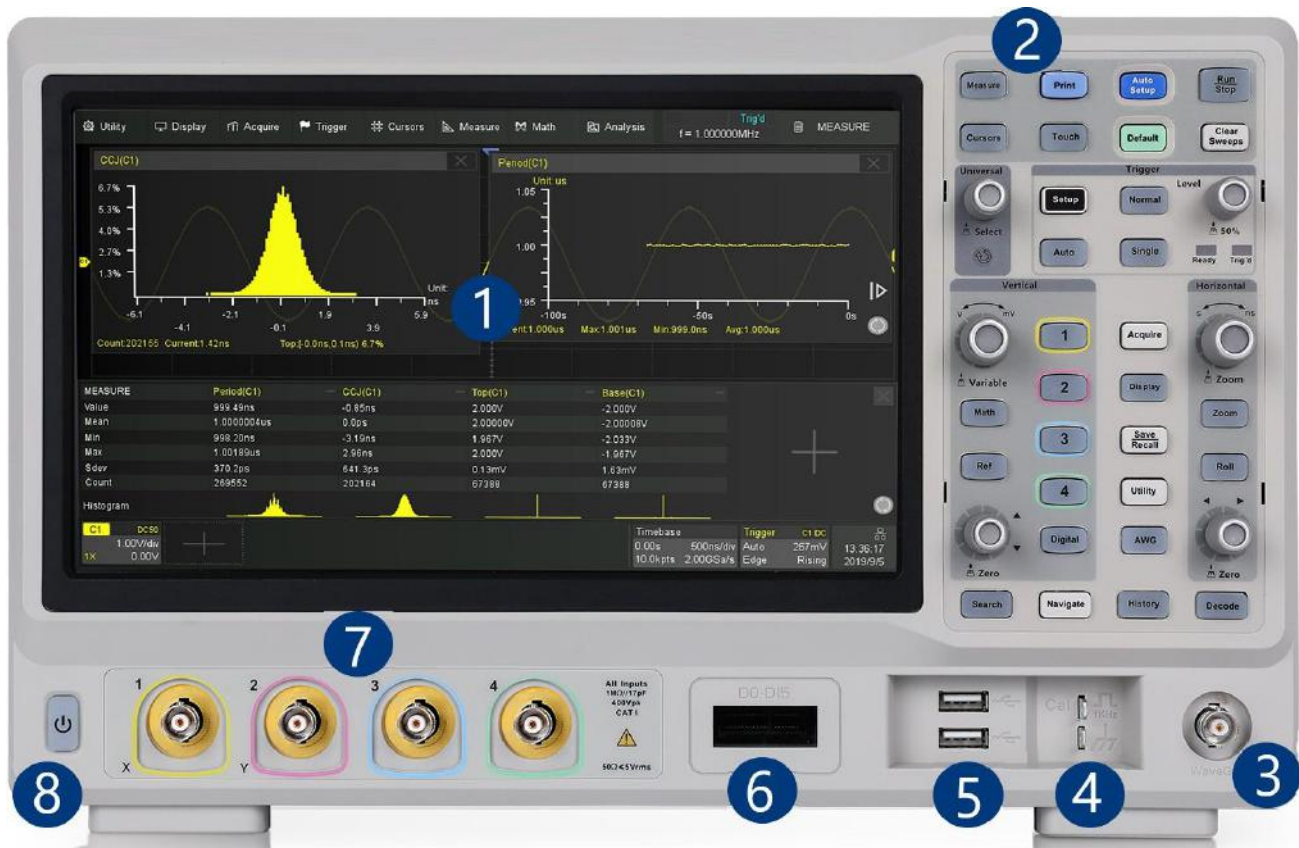

Figure 1.3 Front Panel

Item	Name	Description
1	Touch Screen	Visual presentation of the device function and measurements. See section Touch Screen Display for more details.
2	Control Panel	Includes control knobs and keys. See section Control Panel
3	WaveGen	Built-in waveform generator output.
4	Probe Compensation	Supplies a 0-3.3 V, 1 kHz square wave for compensating the probes.
5	USB Host Port	USB port used to connect flash drives. (Type A)
6	Digital Input Connector	Receives digital signals from the LP2560 digital probe.
7	Analog Input Channels	Input channels (Default: 1 M Ω)
8	Power Button	Power the unit ON or OFF.

Table 1.2 Front Panel

1.6 Rear Panel Overview



Figure 1.4 Rear Panel Overview

Item	Name	Description
1	Auxiliary Out	Outputs the trigger indicator. When Pass / Fail is enabled, outputs the pass / fail signal.
2	External Trigger Input	The external trigger input can be used as a source in several of the trigger types.
3	USB Interface	Connect a USB type B to type A to remotely control the unit.
4	LAN	Connect an ethernet cable to remotely control the unit over the network.
5	Safety Lock Hole	lock the instrument to a fixed location using the security lock via the lock hole. Lock is not included.
6	AC Power Input & Fuse Box	Houses the fuse as well as the AC input .
7	Handle	Handle for easy carrying of the instrument.

Table 1.3 Rear Panel

1.7 Touch Screen Overview

Use your fingers to touch, drag, pinch, spread, or draw a selection box.



Figure 1.5 Touch Screen Overview

Item	Name	Description
1	Menu Bar	Displays the available options in the selected menu.
2	Trigger Delay Indicator	Displays the trigger status.
3	Trigger Status	Displays the trigger status.
4	USB Host Port Indicator	Indicates that a USB is connected to the instrument.
5	LAN Port Indicator	Indicates the status of the LAN connection.
6	Menu Bar	Displays the available options in the selected menu.

Table 1.4 Touch Screen Overview

Getting Started

Before connecting and powering up the instrument, review the instructions in this section.

2.1 Input Power Requirements

The oscilloscope has a universal AC input that accepts line voltage and frequency input within:

Line		
Voltage Range	100-120 V	100-240 V
Frequency	400 Hz	50/60 Hz
Power	80W Max	

Table 2.1

Before connecting to an AC outlet or external power source, be sure that the power switch is in the OFF position and verify that the AC power cord, including the extension line, is compatible with the rated voltage/current and that there is sufficient circuit capacity for the power supply. Once verified, connect the cable firmly.



The included AC power cord is safety certified for this instrument operating in rated range. To change a cable or add an extension cable, be sure that it can meet the required power ratings for this instrument. Any misuse with wrong or unsafe cables will void the warranty.



SHOCK HAZARD:

The power cord provides a chassis ground through a third conductor. Verify that your power outlet is of the three-conductor type with the correct pin connected to earth ground.

2.2 Fuse Requirements and Replacement

For continued fire protection at all line voltages replace only with a 2.00 A / 250 V "T" RATED, 5 x 20 mm fuse.

⚠ WARNING

For safety, no power should be applied to the instrument while changing line voltage operation. Disconnect all cables connected to the instrument before proceeding.

Check and/or Change Fuse

- Locate the fuse box next to the AC input connector in the rear panel. (See figure 1.4)
- Insert a small flathead screwdriver into the fuse box slit to pull and slide out the fuse box as indicated below.
- Check and replace fuse if necessary. (See figure 2.1)

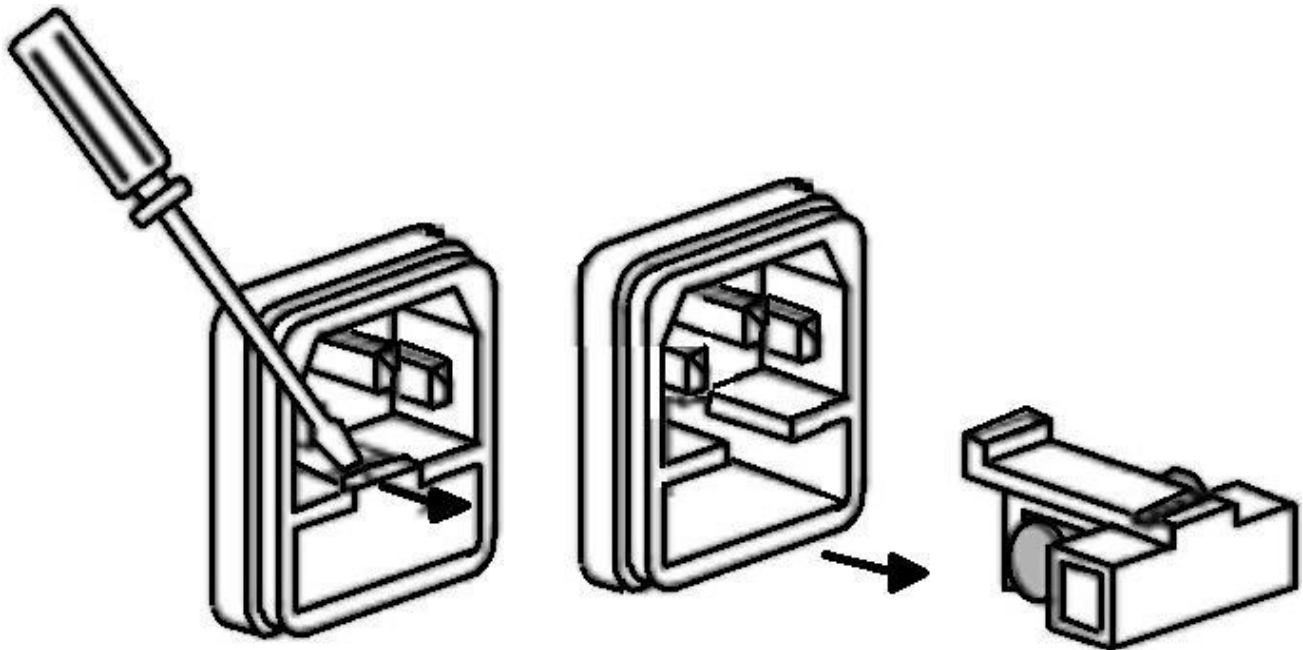

Figure 2.1 Fuse Removal

Any disassembling of the case or changing the fuse not performed by an authorized service technician will void the warranty of the instrument

2.3 Preliminary Check

Complete the following steps to verify that the oscilloscope is ready for use.

2.3.1 Verify AC Input Voltage

Verify proper AC voltages are available to power the instrument.

The AC voltage range must meet the acceptable specification stated in section **Input Power Requirements**.

2.3.2 Connect Power

Connect the AC power cord to the AC receptacle in the rear panel and press the power switch to turn on the instrument.

The instrument will have a boot up screen while loading, after which the main screen will be displayed.

2.3.3 Self-Test

The instrument has 3 self-test option to test the screen ,keyboard, and the LED back light. To perform the self-test, please refer to the **Self Test** section for further instructions.

2.3.4 Self-Cal

Self option runs an internal self-calibration procedure that will check and adjust the instrument. To perform the self-calibration, refer to the Self-Calibration section for further instructions.

2.3.5 Check Model and Firmware Version

The model and firmware version can be verified from within the menu system.

To view the model and firmware version:

Press the **Utility** button and use the softkeys to select the **System Status** option. The following information will be displayed:

- **Software Version**
- **Uboot-OS Version**
- **FPGA Version**
- **CPLD Version**
- **Hardware Version**
- **Scope ID**
- **Serial NO.**
- **Model**

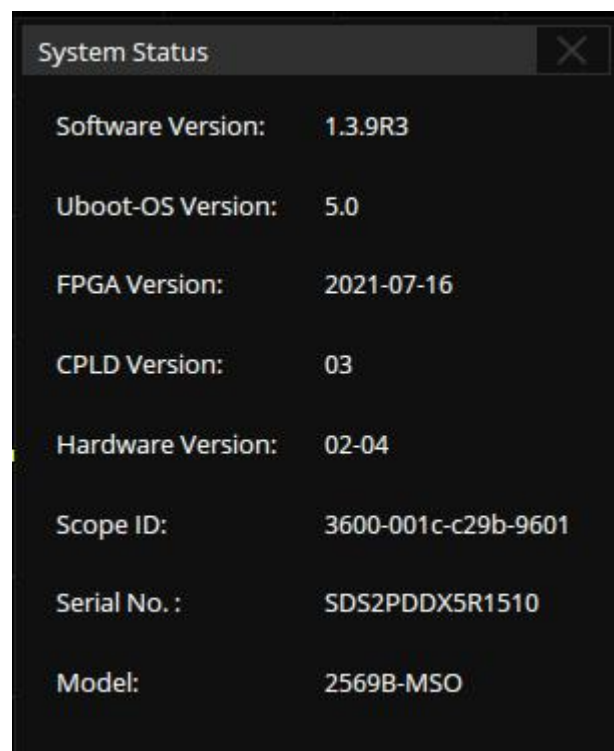

Figure 2.2 System Status

2.3.6 Function Check

Follow the steps below to do a quick check of the oscilloscope's functionality.

1. Power on the oscilloscope. Press "Default Setup" to show the result of the self-check.
 - The probe default attenuation is 1X.
2. Set the switch to 1X on the probe and connect the probe to channel 1.
 - To do this align the slot in the probe connector with the key on the CH1 BNC, push to connect, and twist to the right to lock the probe in place.
 - Connect the probe tip and reference lead to the Probe Comp connectors.
3. Press the **AUTO** button to show the 1 kHz frequency and about 3V peak to peak square wave.

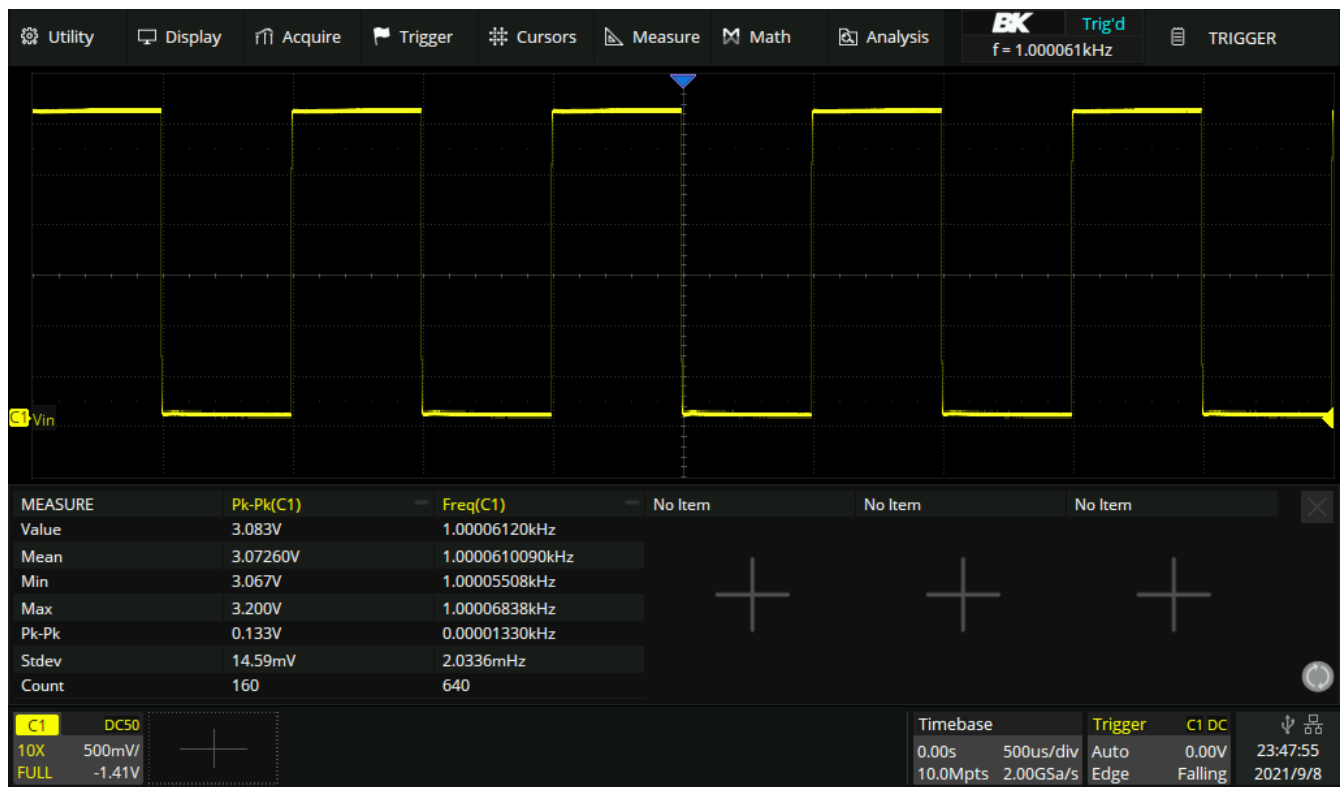

Figure 2.3 3 Vpp Square Wave

4. Repeat steps 1 to 3 for the remaining channels.

2.4 Probe Safety

A guard around the probe body provides a finger barrier for protection from electric shock.

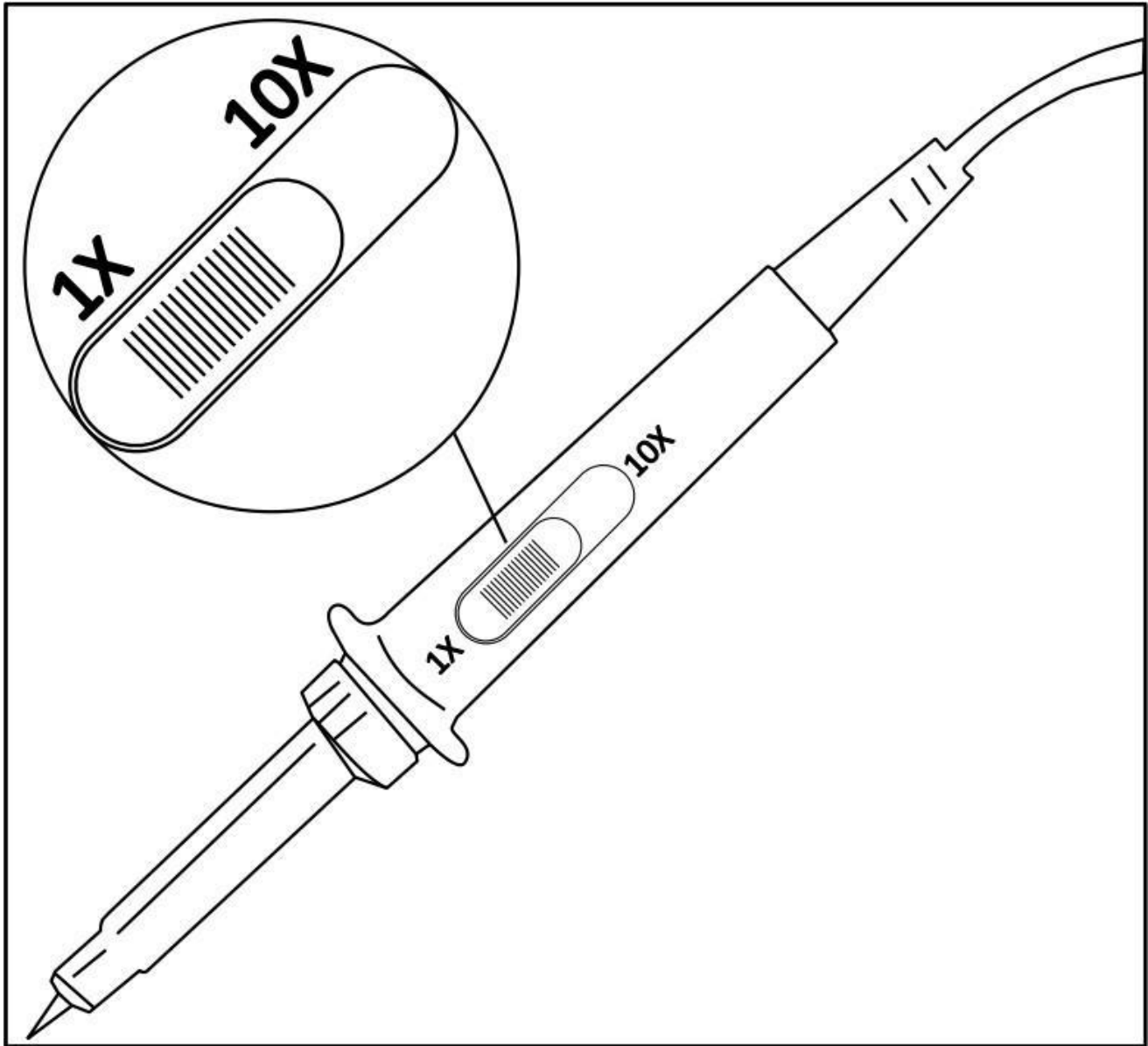

Figure 2.4 Probe

Connect the probe to the oscilloscope and connect the ground terminal to the ground before you take any measurements.



Shock Hazard:

To avoid electric shock when using the probe, keep fingers behind the guard on the probe body. To avoid electric shock while using the probe, do not touch metallic portions of the probe head while it is connected to a voltage source. Connect the probe to the oscilloscope and connect the ground terminal to ground before you take any measurements.

Probe Attenuation

Probes are available with various attenuation factors which affect the vertical scale of the signal. The Probe Check function verifies that the probe attenuation option matches the attenuation of the probe.

Press CH 1 once to open the channel menu. Select the probe option that matches the attenuation of the probe.

Note:

The default setting for the Probe option is 1 X.

Verify that the attenuation switch on the probe matches the Probe option in the oscilloscope. Switch settings are 1 X and 10 X.

Probe Compensation

Before taking any measurements using a probe, verify the compensation of the probe and adjust it to match the channel inputs.

To match your probe to the input channel:

1. Set the channel's probe attenuation to 10X.
 - Press the **CH #** key corresponding to the channel the probe is connected to.
 - Use the softkeys to navigate to page 1.
 - Use the softkeys to select **Probe**.
 - Use the **Intensity Adjust** knob to select 10X.
2. Attach the probe tip to the **Compensation Signal Output Terminal 3 V(Cal)** connector and the reference lead to the **Probe Ground terminal** connector.
 - Press the **Auto Setup** key to display the square wave.
3. Check the shape of the displayed waveform.

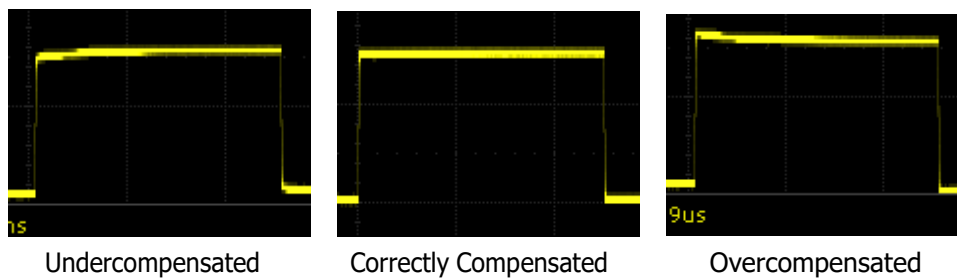

Figure 2.5 Probe Compensation

4. If necessary, adjust your probe's compensation trimmer pot.

Control Panel

The control panel is designed to operate the basic functions without having to open the software menu. Most of the front panel controls duplicate functionality available through the touch screen.

All the knobs on the front panel are multifunctional. They can be pushed as well as rotated. Pushing a knob quickly recalls a specific function, which is indicated by the silkscreen near to the knob.

The **Control Panel** consist of 9 sections:

- **Vertical Control**
- **Horizontal Control**
- **Trigger Control**
- **Run/Stop Key**
- **Auto Setup Key**
- **Analysis Keys**
- **Universal Knob**
- **Menu Keys**
- **Other Keys**



Figure 3.1 Control Panel

3.1 Vertical Control

Channel Keys: Press the channel keys to toggle a channel **On** or **Off**, or to access the channel's menu. There is one channel on/off key for each analog channel.

Digital Key: Enable/disable the digitals channels and display the waveforms. See section **Digital Channels** for more details.

Math Key: The **Math** key provides access to the math (add, subtract, etc.) waveform functions. See section **Math** for more details.

Ref Key: Toggle the reference function on and off.

Vertical Scale Knob: Analog channels (C1-C4), digital channels (d), math (F1-F2) and references (Ref) share the same vertical scale knob. Turn the knob to adjust the gain (volts/div). Push to alternate between coarse and fine adjustments. When the digital channel is active, rotate the knob to change the selected digital channel.

Vertical Position Knob: Analog channels (C1-C4), digital channels (D), math (F1-F2) and references (Ref) share the same vertical position knob. Turn the knob to adjust the DC offset or vertical position of the channel. Push to set the position to zero.

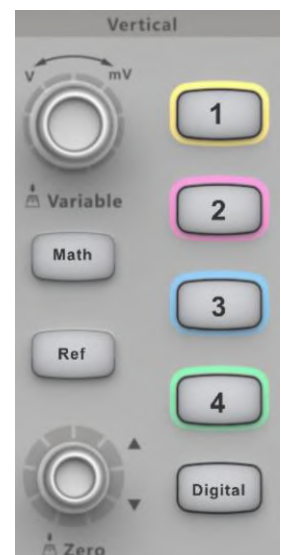

Figure 3.2 Vertical Control

3.2 Horizontal Control

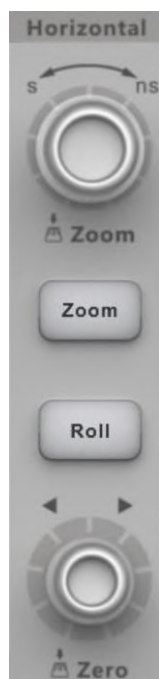

Figure 3.3
Horizontal
Control

Horizontal Scale Knob: Turn the knob to adjust the horizontal scale (time/div). The symbols above the knob indicate that this control has the effect of spreading out or zooming in on the waveform using the horizontal scale.

Push the horizontal scale knob to toggle between fine and coarse adjustment.

Zoom Key: Press the **Zoom** key to split the oscilloscope display into Normal and Zoom sections.

See section **Zoom** for more details.

Roll Key: Toggle the roll function on and off. At timebase settings larger than 50 ms/div, it is recommended to set the oscilloscope to Roll mode so that the waveform is displayed in real time.

See section Roll Mode for more details.

Horizontal Position Knob: Turn the knob marked ◀ ▶ to pan through the waveform data horizontally. The captured waveform before the trigger (turn the knob clockwise) or after the trigger (turn the knob counterclockwise) can be seen. Panning through the waveform when the oscilloscope is stopped (not in Run mode) will display the waveform data from the last acquisition taken.

Push the horizontal position knob to zero the horizontal position.

3.3 Trigger Control



Figure 3.4 Trigger Control

The Trigger controls determine how the oscilloscope triggers to capture data. These controls consist of:

Setup: Opens the **Trigger Setup** menu. In the **Trigger Setup** menu, the trigger type, source, and options that affect all trigger types can be set. See section Triggers for more details.

Normal: Sets the **Trigger Mode** to **Normal**. In **Normal Mode** acquisitions only occur when the trigger conditions are met. Otherwise, the oscilloscope holds the last waveform on the display and waits for the next trigger.

Auto: Sets the **Trigger Mode** to **Auto**. In **Auto Mode** an internal timer triggers the sweep after a preset timeout period if no trigger has been found so that the oscilloscope continuously updates the display whether a trigger occurs or not.

Single: Sets the **Trigger Mode** to **Single**. In **Single Mode** data is a single frame that satisfies the trigger conditions is captured and displayed, and then stops. The following trigger events are ignored until **Single** acquisition is restarted.

Level Knob: Turn the **Level Knob** to adjust the trigger level for a selected analog channel. Push the knob to set the level to the waveform's 50% value. If AC coupling is used, pushing the **Level Knob** sets the trigger level to about 0 V.

Trigger Status: Indicates when the oscilloscope is waiting for a trigger or when a trigger has occurred.

3.4 Run/Stop Key



When the **Run/Stop** key is green, the oscilloscope is running, that is, acquiring data when trigger conditions are met. To stop acquiring data, press the **Run/Stop** key.

When the **Run/Stop** key is red, data acquisition is stopped. To start acquiring data, press the **Run/Stop** key.

To capture and display a single acquisition (whether the oscilloscope is running or stopped), press the **Single** key. The **Single** key will remain green until the oscilloscope triggers.

3.5 Auto Setup Key



Pressing the **Auto Setup** key will cause the oscilloscope to determine which channels have activity, and it will turn these channels on and scale them to automatically configure the input to best display the input signals.

3.6 Analysis Keys



Figure 3.5 Common Functions

Search: Search for events in the acquired data.
See section **Search** for more details.

Navigate: Navigate through captured data via time, search events, or history frame.
See section **Navigate** for more details.



History: Divides the oscilloscope's memory into segments allowing for analysis of individual frames.
See section **History** for more details.

Decode: Enable serial decode.
See section **Serial Decode** for more details.

3.7 Universal Knob



The **Universal Knob** is used to select items from pop-up menus and to change values. The function of the **Universal Knob** changes based upon the current menu.

Note that the curved arrow symbol  below the knob illuminates whenever the **Universal Knob** can be used to select a value. Also, note that when the **Universal Knob**  symbol appears, you can use the **Universal Knob**, to select values.

Rotating the **Universal Knob** adjusts the trace intensity. Pushing the **Universal Knob** instantly sets the intensity to 50%.

Figure 3.6
Universal Knob

3.8 Menu Keys

Acquire: Access the **Acquire** menu. In the acquire menu Interpolation, Acquire Mode, Acquisition, Memory Depth, Sequence, and Resolution can be set.

See section Acquire for more details.

Display: Access the **Display** menu to enable persistence, adjust the display grid (graticule) intensity, label waveforms, add an annotation, and clear the display.

See section Display for more details.

Save/Recall: Save oscilloscope setups, screen images, waveform data, or mask files or to recall setups, mask files or reference waveforms.

See section **Save/Recall** for more details.

Utility: Access the **Utility** menu, to configure the oscilloscope's I/O settings, use the file explorer, set preferences, access the service menu, and choose other options.

AWG: Built-in waveform generator can output arbitrary, sine, square, ramp, pulse, DC, noise, and other 45 built-in waveforms. Modulated waveforms are available except for arbitrary, pulse, DC, and noise waveforms.

See section **Arbitrary Waveform Generator** for more details.

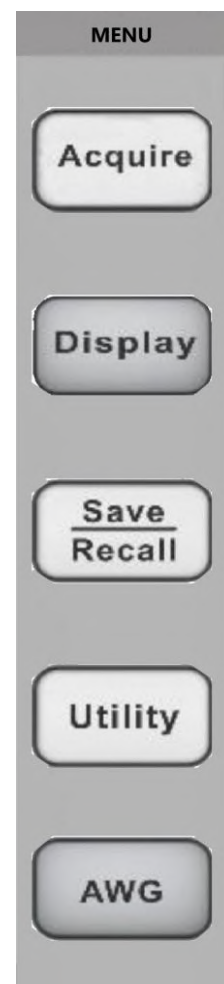

Figure 3.7
Menu Keys

3.9 Other Keys



Press the **Measure** key to access a set of predefined measurements.
See section **Measure** for more details.



Performs a screenshot save to an external storage device.
The supported format includes .bmp .jpg .png

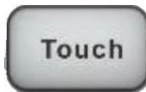

Enables/Disables the touch screen.
The LED on the button lights to indicate that the touch screen is working.



Enables/disable the cursors. Cursors are used to make custom measurements.
See section **Cursors** for more details.



Restores the oscilloscope's default settings.

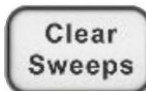

Clears the displayed data and any measurements, including display persistence, measurement statistics, average sweeps, and Pass/Fail statistics.

Acquisition

4.1 Changing Acquisition Mode

To change the Acquisition Mode:

- Use the touchscreen to press the **Acquire Menu** on the **Main Timebase** menu, or press the **Acquire** key on the control panel, or touch the Menu Bar and select **Acquire > Menu** to recall the Acquire menu on the right side.
 - the **Acquire** menu shown in figure 4.1 will be displayed.
- Touch **Resolution** to toggle between **8bits** and **10bits** resolution.
 - The vertical resolution. "8-bits" is the default setting.
 - In **10-bits** mode, the vertical resolution is 4x better, while the bandwidth is limited to about 100 MHz.
- Touch **Interpolation** to toggle between **x** and **Sinc**.
 - At small timebase settings, the number of original points on the screen may be less than the number display pixels in the grid area, so interpolation is necessary to display a continuous waveform. For example, at 1 ns/div timebase and 2 GSa/s sample rate, the number of original points is 20, but the grid area includes 1000 horizontal pixels. In this case, the oscilloscope needs to interpolate the original points by 50.
 - **X**: Linear interpolation, the simplest way of interpolation, connects two original points with a straight line.
 - **Sinc**: $\text{Sin}(x)/x$ interpolation, the original point is interpolated according to the Nyquist reconstruction formula, which has a good time- domain recovery effect for sine wave. But for step signals/fast rise times, it will introduce false overshoot due to the Gibbs phenomenon.

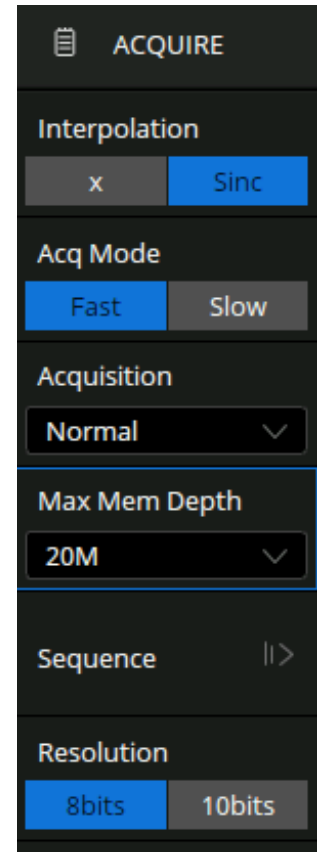

Figure 4.1 Acquire Menu

- Touch **Acq Mode** to toggle between **Fast** and **Slow** acquisition.
 - **Fast** is the default setting. A very high waveform update rate is provided in fast mode.
 - **Slow** mode will slow down the waveform update.
- Touch **Acquisition** to determine how to acquire and process the signal.
 - **Normal**: The oscilloscope samples the signal with an equal time interval. For most waveforms, the best display effect can be obtained using this mode.
 - **Peak**: The oscilloscope acquires the maximum and minimum values of the signal within the sample interval so that the peak (maximum – minimum) in the interval is obtained. This mode is effective to observe occasional narrow pulses or spurs with a low sample rate, but the noise displayed is larger. In peak mode, the oscilloscope will display all pulses with a pulse width longer than 400 ps.
- Touch **Memory Depth** to set the maximum memory depth that is supported.

- acquisition time = sample points x sample interval", setting a larger memory depth can achieve a higher sample rate for a given time base, but more samples require more processing time, degrading the waveform update rate. With 200 Mpts memory depth, the 2560B series can still run at full sample rate (2 GSa/s) even when set to the 10 ms/div timebase.

Note:

The memory depth here is the upper limit of the memory space allocated by the oscilloscope. The actual sample points are related to the current timebase and may be less than memory depth. The actual sample points information can be obtained in the timebase descriptor box (see the section "Timebase and Trigger" for details).

The maximum memory depth in single-channel mode is 2 times that of the dual-channel mode, as the following table:

Single-Channel Mode	Dual-Channel Mode
20k	10k
200k	100k
2M	1M
20M	10M
200M	100M

Table 4.1 Memory Depth

Single-channel mode (interleaving mode): Only one of C1/C2 is turned on, and only one of C3/C4 is turned on.

Dual-channel mode (non-interleaving mode): Both C1/C2 are turned on, or both C3/C4 are turned on.

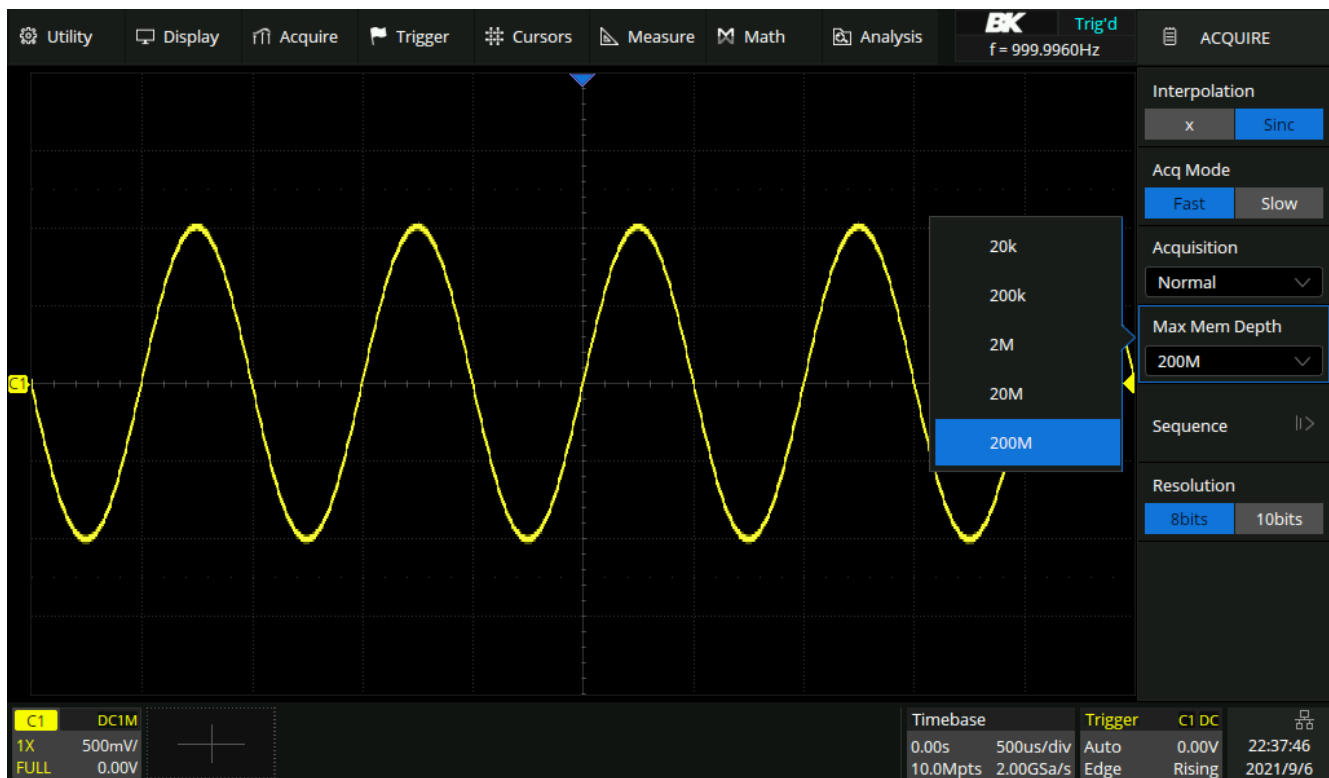

Figure 4.2 Memory Depth

4.2 Sequence

Sequence mode is a fast acquisition mode, which divides the memory depth to multiple segments (up to 90,000), each of which stores a single shot.

In sequence mode, the oscilloscope only acquires and stores data without processing and displaying, until the specified segments are acquired. As a result, the dead time between trigger events is minimized, improving the waveform update rate.

If sequence mode is enabled, the display will not update until all of the sequences have been acquired. The 2560B series can achieve a minimum 2 s trigger interval in sequence mode, corresponding to a waveform update rate of 500,000 wfms/s.

Sequence mode can capture and record rare events over long time periods. The oscilloscope can capture multiple events that satisfy the trigger conditions, ignoring the periods of no interest between adjacent events, maximizing the use of waveform memory. Full accuracy of the acquisition timebase can be used to measure selected segments.

After the acquisition is finished, the oscilloscope will map all the segments together to the screen. To view and analyze each frame separately, use history mode (see the section "History" for details). History mode provides timestamp labels for each segment.

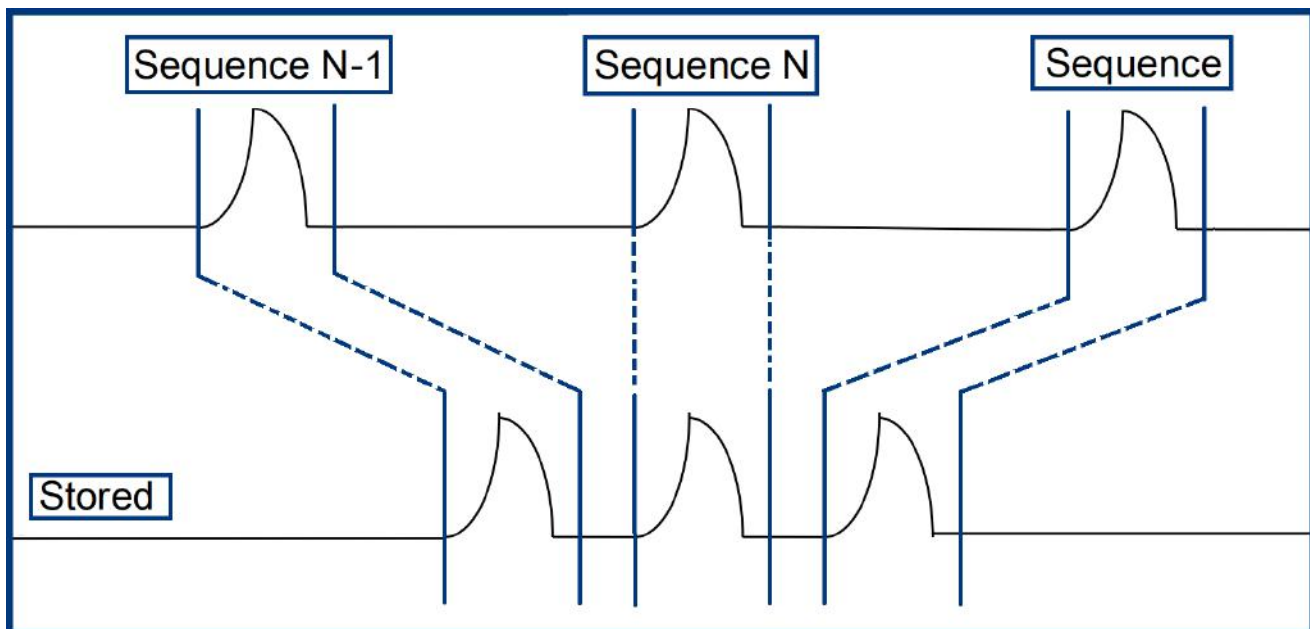

Figure 4.3 Sequence





History

The history function can record the waveforms of the input channels before press the **Run/Stop** button. In run state, the oscilloscope records input waveform continually; when the memory is full (reach the maximal frame), the new frames will cover the old frames and keep the latest frames.

The oscilloscope automatically stores acquired frames. It can store up to 90,000 frames but the number may vary due to the memory depth and timebase settings. Turn on history mode, then the stored frames can be recalled and measured.

In sequence mode, all waveforms that satisfy the trigger conditions are mapped to the display.

To view a single frame:

1. Press the **History** button on the front panel to enable the History function.
 - The history menu shown in figure 5.1 will be displayed.
2. Touch **History** to toggle the history function on and off.
3. Touch **Frame No.** and use the **Universal Knob** or the virtual keypad to specify the frame index.
4. Touch **List** to toggle the list function on and off.
5. Touch the navigation options  on to play backward, stop, or play forward.
 - Touch **List Time Type** to toggle the type between **Acq Time** and **Delta T**.
6. Touch **Interval Time** to set the playing interval by using the **Universal Knob** or the virtual keypad.
 - In addition to manually specifying a frame, history mode supports auto-play.
 - Touch the  option to replay the waveform from the current frame to the first.
 - Touch the  option to stop replay.
 - Touch the  option to replay the waveform from the current frame to the last.

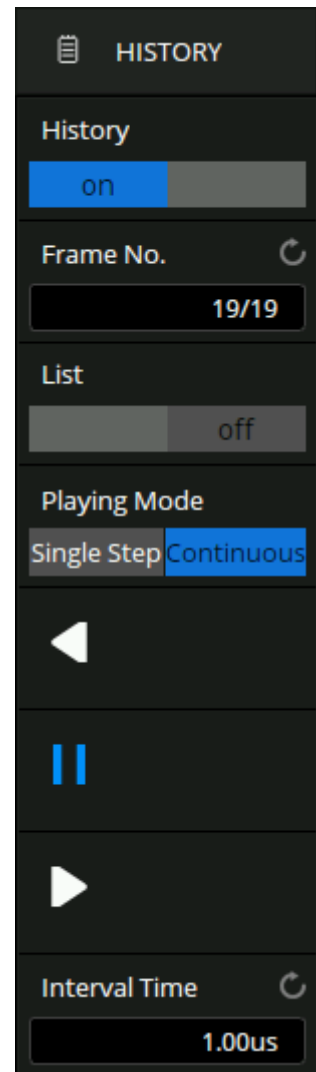

Figure 5.1 History Menu

Horizontal Control

The horizontal controls include:

- Touchscreen controls for setting :
 - Horizontal scale and position (delay)
 - Accessing the **Main Timebase** menu.
 - Navigating
- The horizontal scale and position knobs.
- The **Zoom** key for quickly enabling/disabling the split-screen zoom display.
- The **Search** key for finding events on analog channels or in serial decode.
- The **Navigate** keys for navigating time, search events, or segmented memory acquisitions.

6.1 Adjusting the Horizontal Scale (time/div)

To adjust the horizontal scale:

- Use the touchscreen horizontal pinch gesture
- Use the touchscreen controls to open the **Main Timebase** dialog by pressing the timebase descriptor box.

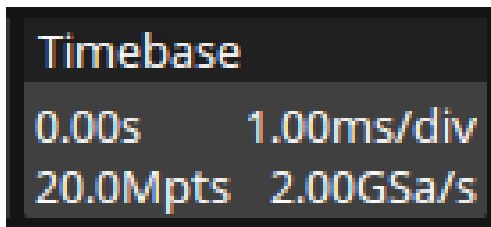



Figure 6.1
Timebase Descriptor Box

- Press the **Timebase** box to set the horizontal scale by the virtual keypad.
- Press  to increase and  to decrease the horizontal scale.
- The **Horizontal Scale Knob** can also be turned to adjust the horizontal time/div setting.

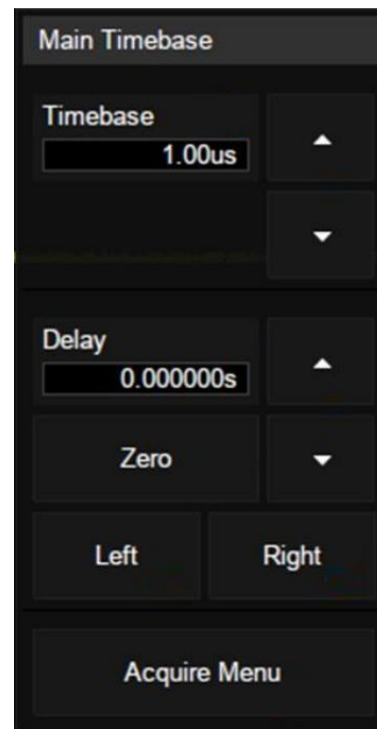

Figure 6.2
Main Timebase Menu

Note:

The **Horizontal Scale Knob** has a different purpose in the **Zoom display**. See section **Zoom** for more details

6.2 Adjusting the Horizontal Delay (position)

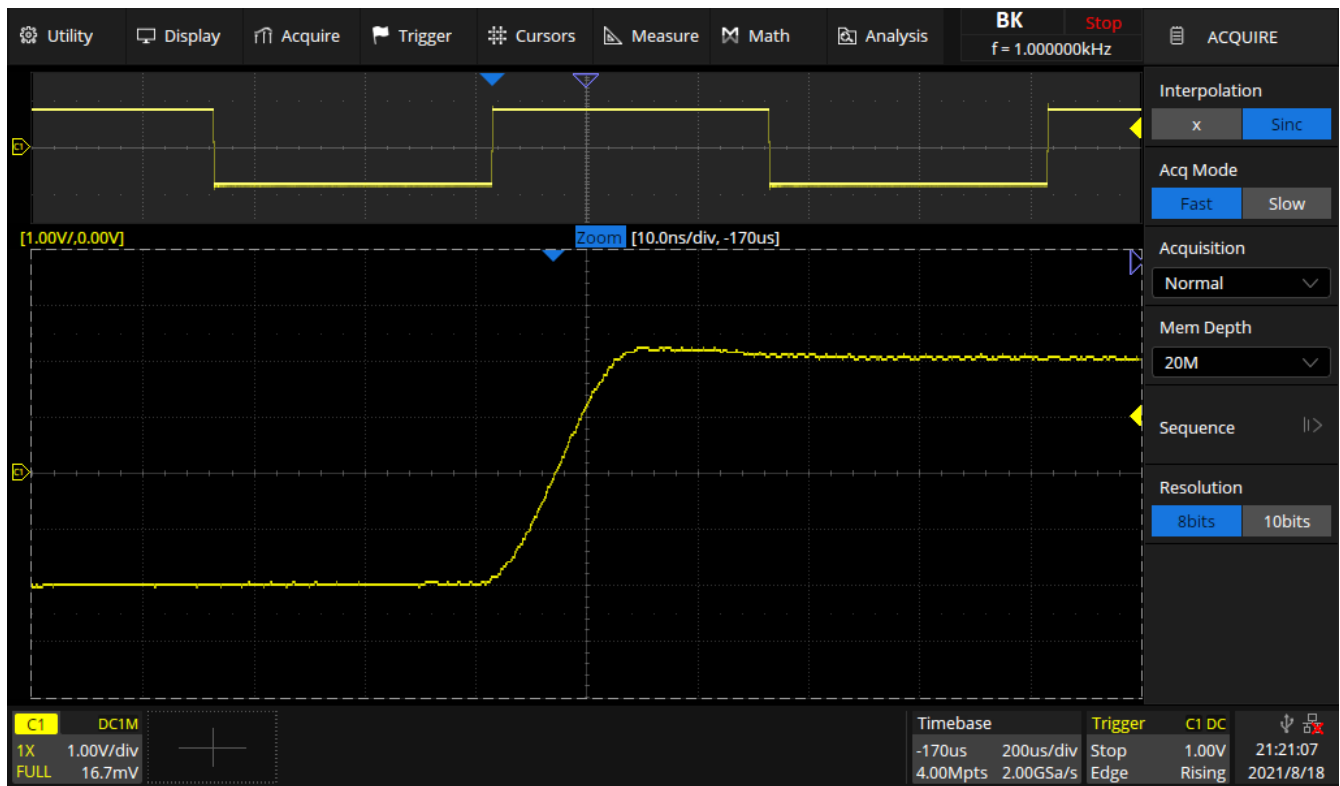

Figure 6.3 Horizontal Setup

To adjust the horizontal delay (position):

- Use the touchscreen horizontal drag gesture.
- Use the touchscreen controls to open the **Main Timebase** dialog by pressing the timebase descriptor box.

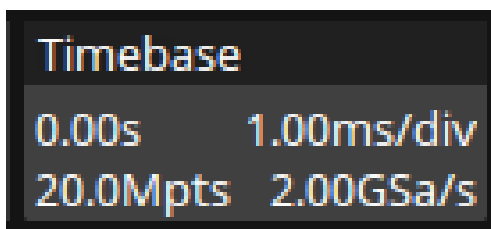



Figure 6.4
Timebase Descriptor Box

- Press the **Delay** box to set the horizontal scale by the virtual keypad. (Figure 6.5)
- Press  to increase and  to decrease the horizontal scale.
- The **Horizontal Position Knob** can also be turned to adjust the horizontal time/div setting.

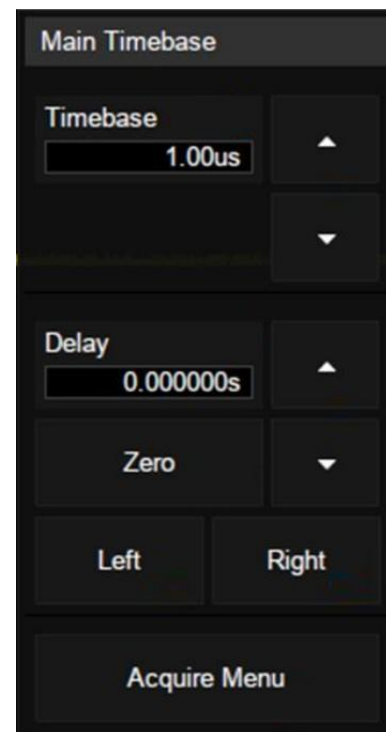

Figure 6.5 Main Timebase Menu



Changing the delay time moves the trigger point (solid inverted triangle ) horizontally and indicates how far it is from the time reference point (hollow inverted triangle ). These reference points are indicated along the top of the display grid.

Figure 6.3 shows the trigger point with the delay time set to 170 μ s. The delay time number tells you how far the time reference point is located from the trigger point. When delay time is set to zero, the delay time indicator overlays the time reference indicator.

All events displayed left of the trigger point happened before the trigger occurred. These events are called pre-trigger information, and they show events that led up to the trigger point.

Everything to the right of the trigger point is called post-trigger information. The amount of delay range (pre-trigger and post-trigger information) available depends on the time/div selected and memory depth.

The horizontal position knob works (in the Normal time mode) while acquisitions are running or when they are stopped. When running, adjusting the horizontal scale knob changes the sample rate. When stopped, adjusting the horizontal scale knob lets you zoom into acquired data.

Note:

The **Horizontal Position Knob** has a different purpose in the **Zoom display**. See section **Zoom** for more details

6.3 Panning and Zooming Single or Stopped Acquisitions

When the oscilloscope is stopped, use the touchscreen horizontal pinch or drag gestures or use the horizontal scale and position knobs to pan and zoom your waveform. The stopped display may contain several acquisitions worth of information, but only the last acquisition is available for pan and zoom.

The ability to pan (move horizontally) and scale (expand or compress horizontally) an acquired waveform is important because of the additional insight it can reveal about the captured waveform. This additional insight is often gained from seeing the waveform at different levels of abstraction. You may want to view both the big picture and the specific little picture details. For example, figure 6.3 demonstrates how these features bring insight on the waveform's rise time.

6.4 Horizontal Scale (Coarse/Fine)

To change the horizontal scale knob adjustment setting:

- Push the **Horizontal Scale Knob** to toggle between fine and coarse adjustment.

When Fine is enabled, turning the horizontal scale knob changes the time/div (displayed in the status line at the top of the display) in smaller increments. The time/div remains fully calibrated when Fine is on.

When Fine is turned off, the Horizontal scale knob changes the time/div setting in a 1-2-5 step sequence.

6.5 Zoom

Zoom is a horizontally expanded version of the normal display. When Zoom is selected, the display divides into two windows. The top window covers about a third of the displays. This window displays the normal time/div window. The area of the normal display that is expanded is outlined with a box and the rest of the normal display is ghosted. The box shows the portion of the normal sweep that is expanded in the lower half.

The bottom window covers two-thirds of the screen. This window is a magnified portion of the normal time/div window. Use Zoom to locate and horizontally expand part of the normal window for a more detailed analysis of the waveform.

To enable the Zoom function:

- Press the **Zoom** key or push the **Horizontal Scale Knob**.
 - Zoom can also be enabled using the touch screen. Press the **Acquire** option located on the Menu Bar. Then press **Zoom**.



Figure 6.6 Zoom

To change the time/div for the Zoom window, turn the **Horizontal Scale Knob**. As you turn the knob, the zoomed window time/div is highlighted in the status line above the waveform display area. The Horizontal scale knob controls the size of the box.

The Horizontal position knob sets the left-to-right position of the zoom window. Negative delay values indicate you're looking at a portion of the waveform before the trigger event, and positive values indicate you're looking at the waveform after the trigger event.

To change the time/div of the normal window, turn off Zoom by pressing the **Zoom** key ; then, turn the **Horizontal Scale Knob**.

6.6 Roll

Roll causes the waveform to move slowly across the screen from right to left. It only operates on the time bases settings of 50 ms/div and slower. If the current time base settings are faster than the 50 ms/div limit, it will be set to 50 ms/div when Roll mode is entered.

To enable the Roll mode:

- Press the **Roll** key.
 - Roll can also be enabled using the touch screen. Press the **Acquire** option located on the Menu Bar. Then press **Roll**.

In Roll mode there is no trigger. The fixed reference point on the screen is the right edge of the screen and refers to the current moment in time. Events that have occurred are scrolled to the left of the reference point. Since there is no trigger, no pre-trigger information is available.

If you would like to pause the display in Roll mode press the **Single** key. To clear the display and restart an acquisition in Roll mode, press the [Single] key again.

Use Roll mode on low-frequency waveforms to yield a display much like a strip chart recorder. It allows the waveform to roll across the display.

Vertical Control

The vertical controls include:

- Touchscreen controls for setting:
 - Vertical scale and position (offset)
 - Accessing the **Channel** menus.
- The vertical scale and position knobs for each analog channel.
- The channel keys for turning a channel on or off.

Figure 7.2 shows the Channel 1 Menu that appears after pressing the **1** channel key.

7.1 Enabling Channels

Push the channel button (1 - 4) to turn on the corresponding channel. Its channel descriptor box and Channel menu will appear on the display. Push the same button again to disable the channel. The channel menu also has an on/off option.

7.1.1 Channel Enable/Disable From the Touch Screen

Touch the + button shown on figure 7.1 and then select a channel to turn it on. The selected channel's descriptor box and a menu box will appear on the display. Touch the channel descriptor box and then touch the Off button to disable it.

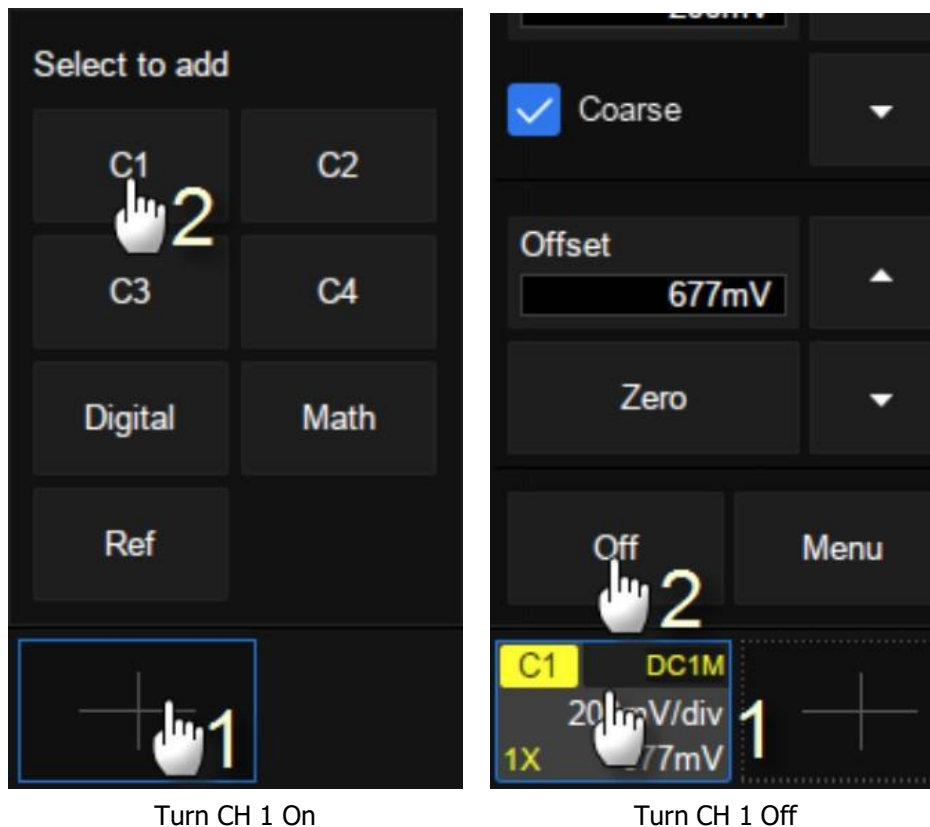

Figure 7.1 Front View

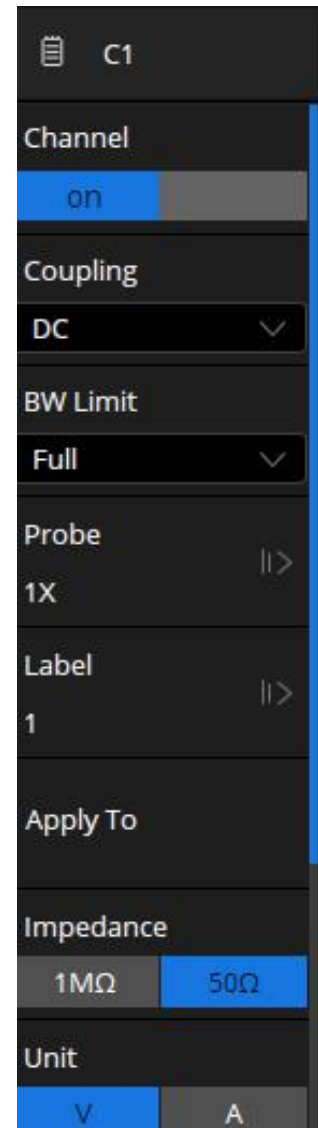

Figure 7.2 Channel 1 Menu

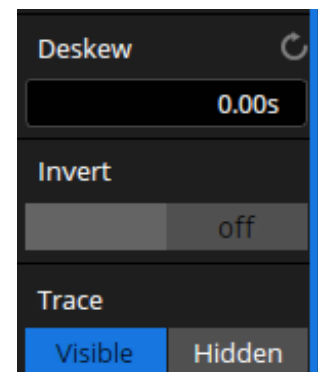

Figure 7.3 Channel 1 Menu Continued

7.2 Vertical Scale

The **Vertical Scale Knob** changes the analog channel scale in a 1-2-5 step sequence (with a 1:1 probe attached), unless Fine Adjustment is enabled.

The analog channel's vertical scale (Volts/div) value is displayed in the channel's descriptor box.

To adjust the vertical scale:

- Use the touchscreen vertical pinch gesture.
- Touch the channel descriptor box to open the vertical scale/offset dialog.
- Turn the **Vertical Scale Knob**.

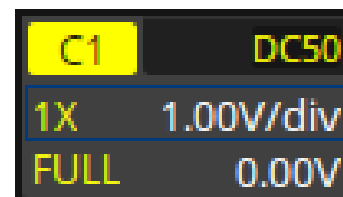

Figure 7.4
Channel Descriptor Box

7.2.1 Coarse/Fine Adjustment

Push the channel's vertical scale knob (or press the channel's descriptor box then uncheck Coarse) to toggle between fine and coarse adjustment of the vertical scale.

When **Fine** adjustment is selected, you can change the channel's vertical sensitivity in smaller increments. The channel sensitivity remains fully calibrated when **Fine** is on.

When Fine is turned off, turning the **Vertical Scale Knob** changes the channel sensitivity in a 1-2-5 step sequence.

7.3 Vertical Position

The offset voltage value represents the voltage difference between the vertical center of the display and the ground level ( icon).

To adjust the vertical position:

- Use the touchscreen pinch and drag gestures.
- Touch the channel descriptor box to open the vertical scale/offset dialog.
- Turn the **Vertical Position Knob** to move the channel's waveform up or down on the display.

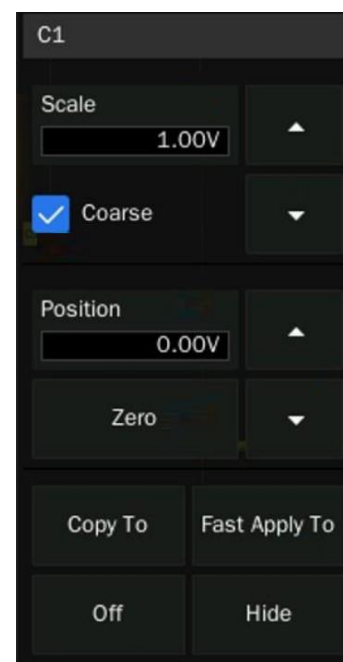

Figure 7.5
Vertical Scale/Offset Dialog

Note:

Push the **Vertical Position Knob** to set the ground level to zero.

7.4 Channel Setup

Pressing the **Channel** key to open the corresponding channel menu. As shown in figures 7.2 and 7.3 the following options can be configured:

- **Channel Coupling**
- **BW Limit**
- **Probe**
- **Label**
- **Apply To**
- **Impedance**
- **Unit**
- **Deskew**
- **Invert**
- **Trace**

7.4.1 Channel Coupling

Coupling changes, the channel's input coupling to either **AC** (alternating current), **DC** (direct current), or **GND** (ground).

DC (Direct Current)

All of the input signal frequency components are passed to the display.

DC coupling is useful for viewing waveforms as low as 0 Hz that do not have large DC offsets.

Note:

If the channel is DC coupled, you can quickly measure the DC component of the signal by simply noting its distance from the ground.

Alternating Current

The signal is capacitively coupled. DC signal components are rejected. See the datasheet for details of the cut-off frequency. AC coupling is suitable for observing AC signals with DC offset, such as power ripple.

AC coupling is useful for viewing waveforms with large DC offsets.

AC coupling places a 10 Hz high-pass filter in series with the input waveform that removes any DC offset voltage from the waveform.

Note:

If the channel is AC coupled, the DC component of the signal is removed, allowing for greater sensitivity to display the AC component of the signal.

Ground

The channel is grounded by an internal switch. GND coupling is used to observe the zero offset error of the analog channels or determine the source of noise in the waveform (from signal or from oscilloscope itself).

To set the channel coupling:

1. Press the desired channel key.
2. In the **Channel Menu**, use the touchscreen to press the **Coupling** option.
 - A drop-down menu will appear with all 3 coupling option.
 - Use the touchscreen to select the desired coupling.

Note:

Channel Coupling is independent of **Trigger Coupling**. To change trigger coupling see **Trigger Coupling**.

7.4.2 Bandwidth Limit

Full bandwidth will pass through signals with high-frequency components, but it also means that noise with high-frequency components can pass through. When the frequency component of a signal is very low, better signal-to-noise ratios (SNR) can be obtained by enabling one of the available bandwidth limits.

The 2560 provides two bandwidth limit options: 20 MHz and 200 MHz. The bandwidth limit effectively lowers the input frequency response of the input to the selected limit value.

For waveforms with frequencies below the bandwidth limit, turning the bandwidth limit on removes unwanted high frequency noise from the waveform.

To set the bandwidth limit:

1. Press the desired channel key.
2. In the **Channel Menu**, use the touchscreen to press the **BW Limit** option.
 - A drop-down menu will appear with three bandwidth options.
 - Use the touchscreen to select the desired bandwidth limit.

7.4.3 Probe Attenuation

This is set automatically if the oscilloscope can identify the connected probe. The 2560 provides 1X, 10X, 100X and custom probe attenuation factor options. The custom values can be between 10^{-6} to 10^6 . The oscilloscope will automatically convert the vertical scale according to the current probe attenuation factor.

For example, the vertical scale of the oscilloscope under 1X attenuation is 100 mV/div, and the vertical scale will be automatically set to 1 V/div if the probe attenuation is changed to 10X. If a standard probe with readout terminal is connected, the oscilloscope will automatically set the probe attenuation to match the probe.

To set the probe attenuation:

1. Press the desired channel key.
2. In the **Channel Menu**, use the touchscreen to press the **Probe** option.
 - The **Probe** submenu will appear with four bandwidth options.
 - Use the touchscreen to select the desired probe attenuation.

7.4.4 Label

Customize the label text, of the selected source. The source can be C1 - C4, F1 or F2, and RefA - RefD.

The length of the label is limited to 20 characters. The characters beyond this length will not be displayed.

When the **Display** option is set to "on", the label will be displayed on the right side of the channel offset indicator.



Figure 7.6 Label Submenu

To set and enable a channel's label:

1. Press the desired channel key.
2. In the **Channel Menu**, use the touchscreen to press the **Label** option.
 - The **Label** submenu will appear.
 - Select a source to assign the label to the specified source.
 - Enable/disable the label using the **Display** option
 - Set the text of the label in the **Label Text** option.



Label On



Label Off

Figure 7.7 Label

7.4.5 Apply To

Common functions such as Trigger, Cursor, Measure, FFT, Search, Mask Test, Counter, and AWG can be quickly applied to the selected channel using the **Apply To** option. Once a function is specified, it will switch directly to the function menu and automatically set that channel as the source.

To apply a function:

1. Press the desired channel key.
2. In the **Channel Menu**, use the touchscreen to press the **Apply To** option.
 - A drop-down menu will appear listing the available functions.
 - Use the touchscreen to select the desired function.

7.4.6 Impedance

To change the impedance:

1. Press the desired channel key.
2. In the **Channel Menu**, use the touchscreen to select either **50 Ω** or **1 M Ω** .

1 M Ω : When a passive probe with high impedance is connected, the impedance must be set to 1 M Ω , otherwise the signal will not be detected.

50 Ω : Suitable for high-frequency signals transmitted through 50 Ω coaxial cables and can minimize the amplitude distortion caused by impedance mismatching.

7.4.7 Unit

Channel sensitivity, trigger level, measurement results, and math functions will reflect the measurement units selected. To change the units:

1. Press the desired channel key.
2. In the **Channel Menu**, use the touchscreen to select either **V** or **A**.

Use **Volts** for a voltage probe.

Use **Amps** for a current probe.

7.4.8 Deskew

When measuring time intervals in the nanoseconds (ns) range, small differences in cable length can affect the measurement. Use **Deskew** to remove cable-delay errors between any two channels.

For example, two coaxial cables with a 1-inch difference in length could introduce a skew of more than 100 ps. In some scenarios (e.g. measuring the setup/hold time between clock and data), it may be necessary to compensate the skew between channels.

The method of compensation: Probe the same signal simultaneously using two channels (including the cables or probes that you intend to use for measurements) and adjust the deskew parameter of one channel until the waveforms of the two channels observed on the screen coincide horizontally.

7.4.9 Invert

When **Invert** is enabled, the waveform is displayed 180 degrees opposite to the earth potential. This is a mathematical inversion and does not physically change the actual potential of the input signal.



Invert Of



Invert On

Figure 7.8 Invert

7.4.10 Trace

When **Visible** is selected, the waveform is displayed.

When **Hidden** is selected, the waveform is not displayed, but the channel is still active.



Visible



Hidden

Figure 7.9 Trace

Digital Channels

This chapter describes how to use the digital channels of a Mixed-Signal Oscilloscope (MSO).

The digital channels are standard on the 2560B MSO models and the 2560B Series DSO models have the upgrade license option.

8.1 LP2560 Probe

The LP2560 is a logic probe designed to monitor up to 16 digital signals at once. The 16 digital channels are separated into two groups and each group has its threshold, making it possible to simultaneously view data from different logic families.

The 16-channel color-coded logic probe consists of two eight-channel pods. To make contact with the DUT, the probe connects directly to square pins or clips to test points using the included grabbers.

With an input capacitance of only 18 pF and 100 k Ω input impedance, the probe protects the integrity of your signal.

The probe is included with MSO models.



Figure 8.1 LP2560 Probe

Note:

To avoid personal injury or damage to the logic probe and any associated equipment, the following safety precautions should be noted.

The equipment shall be used only for the purposes specified by the manufacturer.

The LP2560 probe is used only for BK's special series of oscilloscopes. Protection mechanisms can be compromised if the way the devices connected by the LP2560 are not used for their intended purpose.

Connect and disconnect correctly.

Excessive bending can damage the cable.

Do not use equipment in humid or explosive environment.

Only used indoors. The LP2560 is designed to be used indoors and should only be operated in a clean, dry environment.

Do not use the equipment when you suspect a problem.

Do not use the LP2560 if any parts are damaged. Maintenance work shall be performed by maintenance personnel with appropriate qualifications. Keep the product surface clean and dry.

8.2 Connecting the Digital Probes

1. If necessary, turn off the power supply to the device under test.
 - Turning off power to the device under test only prevents damage that might occur if two lines are accidentally shorted when connecting the probes. The oscilloscope can be powered on because no voltage appears at the probes.
2. Connect the digital probe cable to the **D0-D15** connector located on the front panel.
3. Connect a SMD Mini-grabber test clip to one of the digital ground pins of the probe and then connect the grabber to ground in the device under test.
 - This will improve the signal fidelity and makes sure the oscilloscope gives accurate measurements.
4. Connect a flying lead probe to one of the digital channel pins; connect a grabber to the flying lead probe, and then connect the grabber to the node in the circuit to be tested.
5. Repeat step 4 until all points of interest are connected.

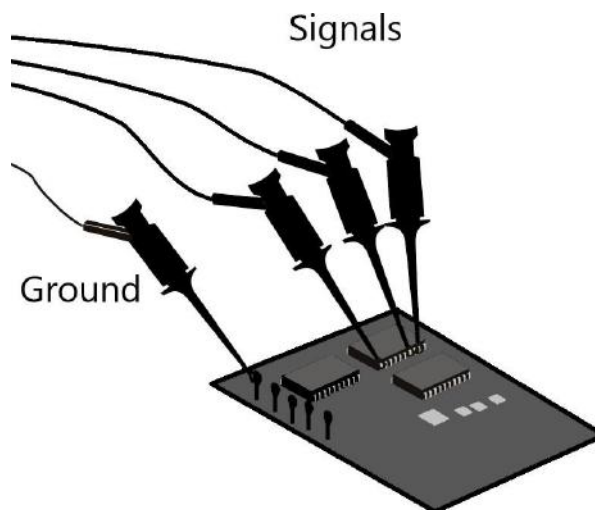

Figure 8.2 Connecting Digital Probes

8.3 Acquiring Digital Waveforms

To acquire digital waveforms:

- Press the **Digital** button to open the digital channels and start acquiring waveforms.

Press the **Run/Stop** or **Single** key to run the oscilloscope, the oscilloscope examines the input voltage at each input probe. When the trigger conditions are met the oscilloscope triggers and displays the acquisition.

For digital channels, each time the oscilloscope takes a sample it compares the input voltage to the logic threshold. If the voltage is above the threshold, the oscilloscope stores a 1 in sample memory; otherwise, it stores a 0.

Digital data can be stored as waveform files. Horizontal cursors and most of the horizontal measurements also apply to digital waveforms.



Figure 8.3 Digital Channels

8.4 Displaying Digital Channels

When signals are connected to the digital channels ensure to connect the ground leads. Autoscale configures and displays the digital channels.

To modify the position and height of the digital channels:

1. Use the touchscreen controls to open the **Digital** dialog by pressing the digital descriptor box.

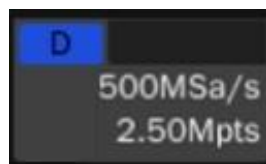

Figure 8.4 Digital Channel Descriptor Box

2. Press the **Position** box to set the vertical position using the virtual keypad. (See figure ??)
 - Press ▲ to increase and ▼ to decrease the vertical position.
3. Press the **Height** box to set the height for all digital channels using the virtual keypad. (See figure ??)
 - Press ▲ to increase and ▼ to decrease the height.

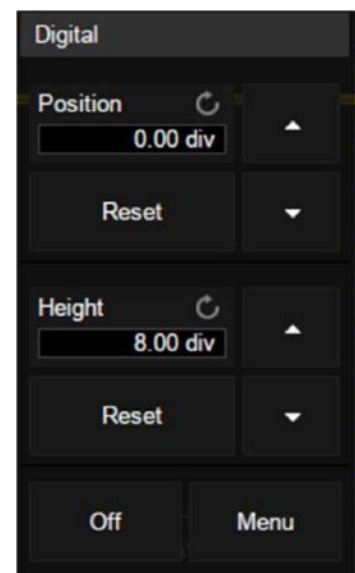



Figure 8.5 Digital Descriptor Menu

8.5 Turning Individual Channels On or Off

Individual or multiple channels can be turned On or Off in the **Channel Setting** menu.

To access the **Channel Setting** menu:

1. Press the **Digital** key to open the **Digital** menu.
2. Use the touchscreen controls to select the  Channel option.

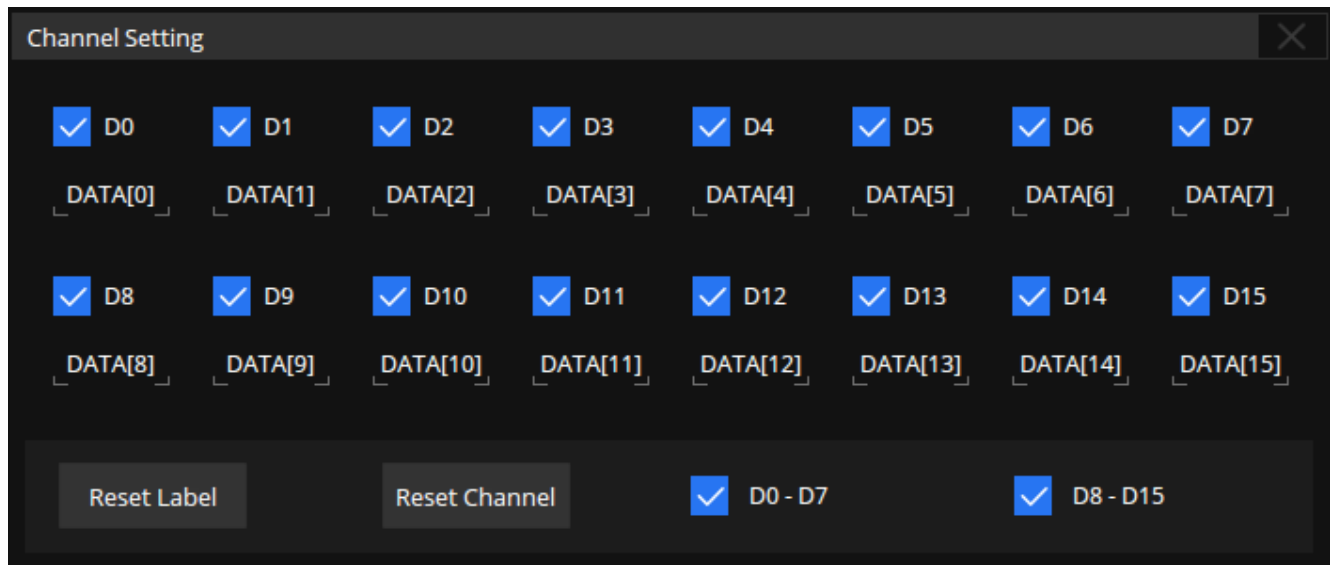

Figure 8.6 Channel Setting

3. Check or uncheck the box to the left of the channel to be turned on or off.
 - D0 - D7 and D8 - D15 can be checked or unchecked to turn multiple on or off at once.

Channel's labels can be swapped by pressing the label of a channel. Once a channel's label is selected the window shown in figure 8.7 will appear. Select the channel whose label you wish to swap.

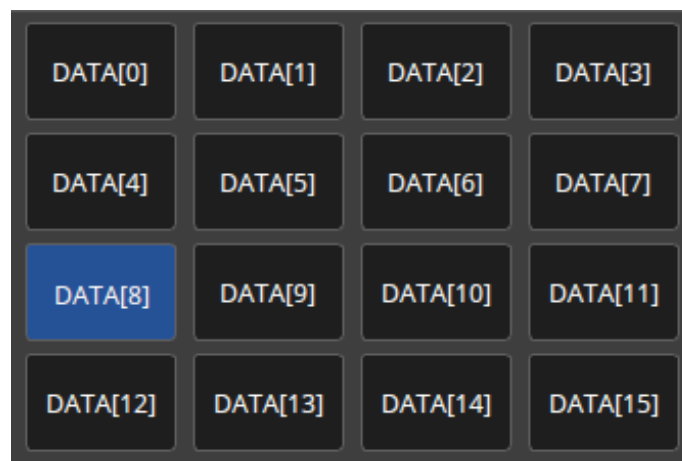

Figure 8.7 Label Swap

To reset all labels press the **Reset Label** option available in the **Channel Setting** menu.

8.6 Logic Threshold for Digital Channels

The threshold level determines how the input signal is evaluated. The threshold level can be set in the **Logic Setting**.

The threshold you set applies to all channels within the selected D7 - D0 or D15 - D8 group. Each of the two channel groups can be set to a different threshold if desired.

Values greater than the set threshold are high (1) and values less than the set threshold are low (0).

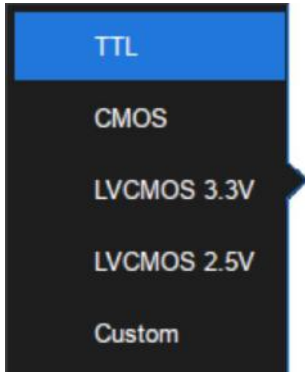

Figure 8.8 Logic Setting

To set a threshold level:

1. Press the **Digital** key to open the **Digital** menu.
2. Use the touchscreen controls to select the **Logic Setting (D7:D0)** or **Logic Setting (D17:D8)** option.
 - The window shown in figure **8.8** will appear.
3. Use the touchscreen controls to select the desired threshold.
 - Refer to table **8.1** for more information on the threshold voltage.
4. If the Thresholds is set to **Custom**, use the touchscreen to select **Threshold** for the channel group, then use the virtual keypad to set the logic threshold.

Logic Family	Threshold Voltage
TTL	1.5 V
CMOS	1.65 V
LVCMOS 3.3 V	1.65 V
LVCMOS 2.5 V	1.25 V
Custom	Variable from -10 V to +10 V

Table 8.1 Logic Thresholds

8.7 Displaying Digital Channels as a Bus

Digital channels may be grouped and displayed as a 16-bit bus, with each value displayed at the bottom of the display in binary, decimal, unsigned dec, or hex.

To configure and display each bus:

1. Press the **Digital** key or use the touchscreen controls to press the **Digital Channel Descriptor Box** to open the DIGITAL menu.
2. Use the touchscreen controls to select the **Bus** option and open the **Digital Bus** menu.
3. Select the **Bus** to be configured. (Two busses are available **Bus1** or **Bus2**)
4. Set the **Data Format**
5. Set the Bit Wide.
6. Enable the bus display.
7. Move the bus vertical position.

Figure **8.9** demonstrates two busses.

B1: 16-bit wide hex format

B2: 16-bit wide binary format



Figure 8.9 Digital Bus

Trigger

For triggering, certain condition can be set according to the requirement and when a waveform in the waveform meets this condition. Digital oscilloscope, display a waveform continuously regardless of the trigger stability, but only stable trigger can ensure stable display.

The trigger circuit ensures that every time base sweep or acquisition starts from the input signal and the user-defined trigger condition, namely every sweep is synchronous to the acquisition and the waveforms acquired overlap to display stable waveform.

The trigger position is movable on the display. Figure 9.1 demonstrates how the position of the trigger event determines the reference time point and the delay setting. The acquisition memory is divided into pre-trigger and post-trigger buffers and the boundary between them is the trigger position.

Before the trigger event arrives, the oscilloscope fills the pre-trigger buffer first, and then continuously updates it in FIFO mode until the trigger event arrives. After the trigger event, the data fills the post-trigger buffer. When the post-trigger buffer is full, an acquisition is completed.

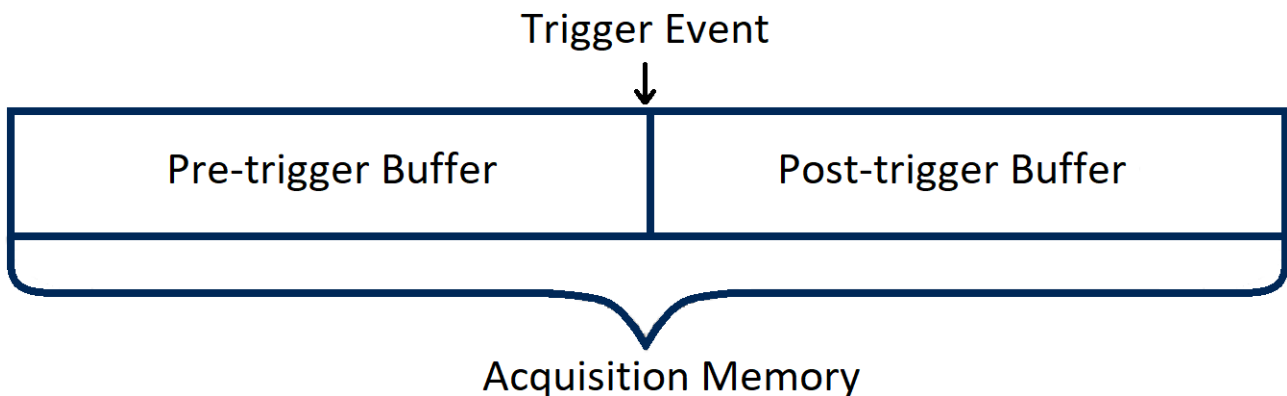

Figure 9.1 Acquisition Memory

A trigger setup tells the oscilloscope when to acquire and display data. Trigger setting are based on the features of the input signal, therefore knowledge of the signal under test is required to quickly capture the desired waveform.

Changes to the trigger setup are applied immediately. If the oscilloscope is stopped when changes are made to the trigger setup, the oscilloscope uses the new specification when the **Run/Stop** or **Single** key is pressed. If the oscilloscope is running when changes are made, the oscilloscope uses the new trigger definition when it starts the next acquisition.

Note:

The 2560B Series oscilloscopes allow the use of either voltage or current units for waveform measurements. The remainder of this chapter will refer to just voltages, but it applies to current levels, too.

9.1 Trigger Source

The 2560B Series trigger source includes four analog channels sixteen Digital channels, Ext, Ext/5, and AC line.

The trigger source is the signal that will be compared to the logical conditions you set to generate a trigger event. The most common trigger source is the signal on one of the analog input channels, but the EXT connector on the back panel can be used to trigger on an external signal.

When looking at waveforms that are derived from the AC line power, you'll probably want to use the AC line as the trigger source. For example, to measure the 120 Hz ripple in a voltage regulator circuit, you'd want to trigger on the 60 Hz AC line for a stable signal.

The trigger sources supported by each trigger type are different. Reference table ?? for more details.

Trigger Type	C1 C4	EXT, EXT/5	AC Line	D0 D15
Edge	√	√	√	√
Slope	√	X	X	X
Pulse	√	X	X	√
Video	√	X	X	X
Window	√	X	X	X
Interval	√	X	X	√
Dropout	√	X	X	√
Runt	√	X	X	X
Pattern	√	X	X	√
Serial	√	X	X	√

Table 9.1 Trigger Source

Once a trigger type has been selected set the trigger source:

1. Press the Setup key or use the touchscreen controls to select **Trigger > Menu...** to enter the **Trigger** menu.
2. Use the touchscreen controls to select **Source**.
 - The **Source Setting** window will appear.
 - Use the touchscreen controls to navigate the available trigger sources.

The currently selected trigger source is displayed at the upper right corner of the Trigger dialog box as shown in figure 9.2.

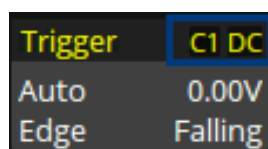
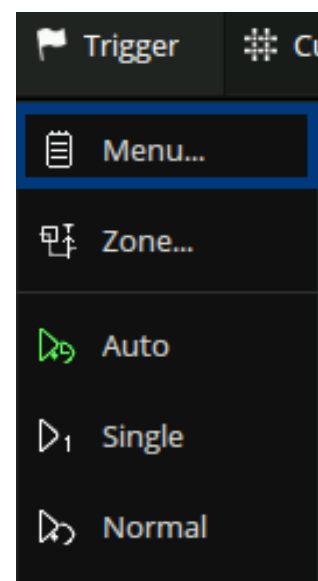

Figure 9.2
Selected Trigger Source



9.2 Trigger Types

The 2560B Series provides the following trigger types :

- **Edge Trigger**
- **Slope Trigger**
- **Pulse Trigger**
- **Video Trigger**
- **Window Trigger**
- **Interval Trigger**
- **Dropout Trigger**
- **Runt Trigger**
- **Pattern Trigger**
- **Serial Trigger**

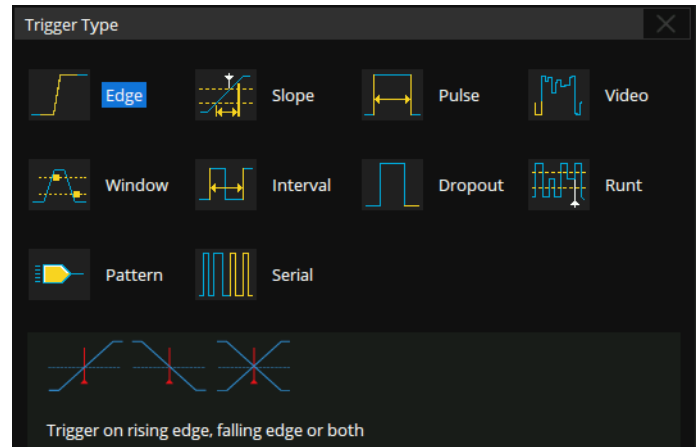

Figure 9.3 Trigger Types

To select a trigger type:

1. Press the Setup key or use the touchscreen controls to select **Trigger > Menu...** to enter the **Trigger** menu.
2. Use the touchscreen controls to select **Type**.
 - The **Trigger Type** window shown in figure 9.3 will appear.
 - Use the touchscreen controls to select a trigger type.

9.2.1 Edge Trigger

Edge trigger distinguishes the trigger points by seeking the specified edge (rising, falling, alter) and trigger level. Trigger source and slope can be set in the trigger menu.

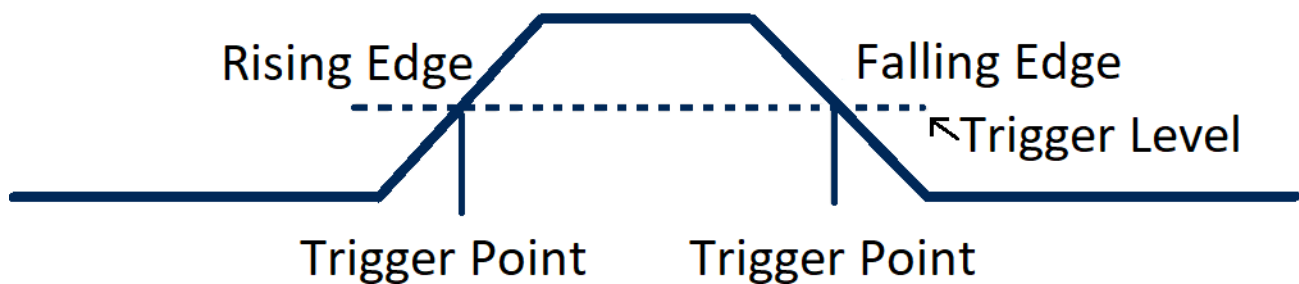

Figure 9.4 Edge Trigger Point

To set the trigger source:

Use the touchscreen controls to select **Source**. Refer to table 9.1 for more information on the available trigger sources.

Set the Trigger Slope

Use the touchscreen controls to select **Slope** in the **Trigger** menu. Select one of the available options.

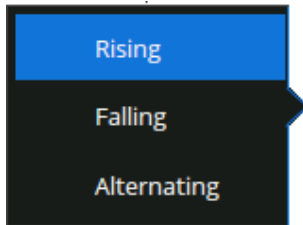

- *Rising* – Only trigger on the rising edge
- *Falling* – Only trigger on the falling edge
- *Alter* – Trigger on both rising edge and falling edge

Figure 9.5 Edge Trigger Slopes

Holdoff, coupling, and noise reject can be set in edge trigger, see the sections **Holdoff**, **Trigger Coupling** and **Noise Reject** for more details.

9.2.2 Slope Trigger

The slope trigger looks for a rising or falling transition from one level to another level in greater than or less than a certain amount of time.

In the oscilloscope, positive slope time is defined as the time difference between the two crossing points of trigger level A and B with the positive edge as shown in the figure below.

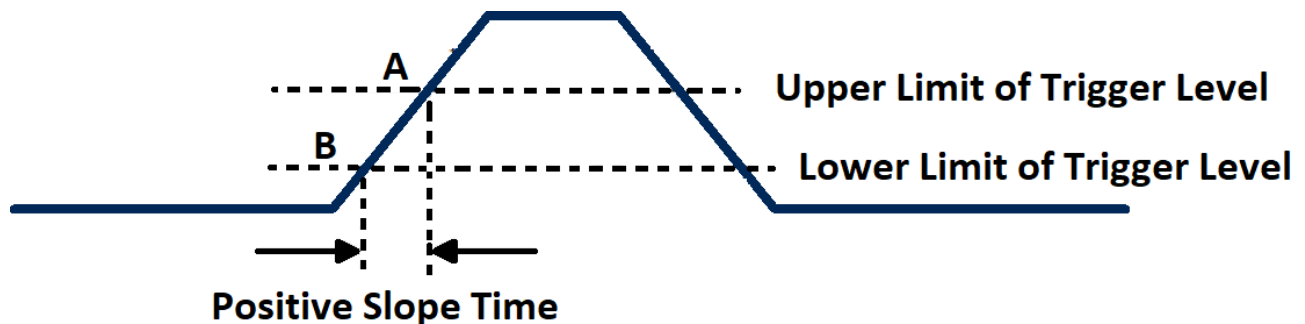

Figure 9.6 Slope Trigger

Configuring a Slope Trigger

To select Slope Trigger type:

1. Press the Setup key or use the touchscreen controls to enter the **Trigger Menu**.
2. Use the touchscreen to select **Type**.
3. The window shown in figure 9.3 will appear.
 - Use the touchscreen to **Slope**.
4. Use the touchscreen to toggle the **Slope** between **Rising** and **Falling**.
 - *Rising*: Only trigger on the positive slope
 - *Falling*: Only trigger on the negative slope

5. Press the **Lower Upper** softkey to select the Lower or Upper trigger level.
 - Turn the Trigger Level Knob to adjust the position.
 - The lower trigger level cannot be higher than the upper trigger level.
6. Use the touchscreen to select the **Limit Range**.

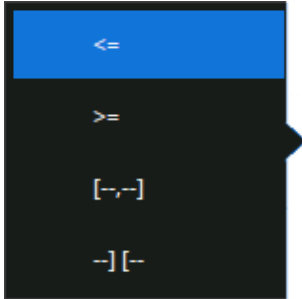

Figure 9.7 Limit Range

- **<= (less than a time value)**: Trigger when the positive or negative slope time of the input signal is lower than the specified time value.
- **>= (greater than a time value)**: Trigger when the positive or negative slope time of the input signal is greater than the specified time value.
- **[- . . -] (within a range of time value)**: Trigger when the positive or negative slope time of the input signal is greater than the specified lower limit of time and lower than the specified upper limit of time value.
- **- -][- (outside a range of time value)**: Trigger when the positive or negative slope time of the input signal is greater than the specified upper limit of time and lower than the specified lower limit of time value.

7. When the trigger type is slope trigger, touch the trigger descriptor box, the trigger dialog box will the upper and lower levels. The upper/lower level can be set in the following two ways.

- Touch the Level Upper area in the quick menu to select the upper level, and then set the level value by the virtual keypad or the Level knob on the front panel. To set the lower level is similar.
- Use the Level knob on the front panel directly to set the level value. Press the knob to switch between upper and lower level, and rotate it to set the value.

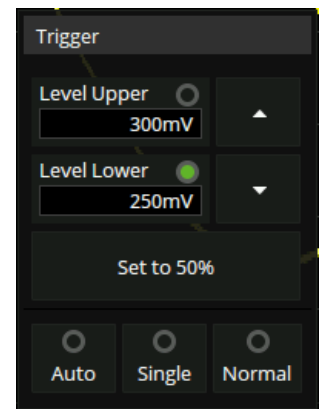

Figure 9.8
Trigger Descriptor Menu

9.2.3 Pulse Trigger

The **Pulse Trigger** type triggers on the positive or negative pulse with a specified width.

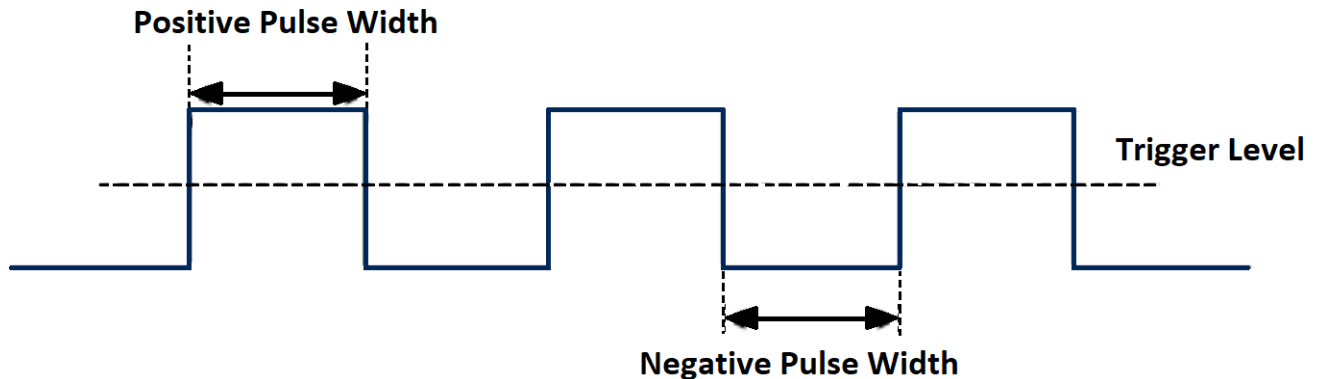

Figure 9.9 Pulse Trigger

To select **Pulse Trigger** type:

1. Press the Setup key or use the touchscreen controls to enter the **Trigger Menu**.
2. Use the touchscreen to select **Type**.
3. The window shown in figure 9.3 will appear.
 - Use the touchscreen to **Pulse**.
4. Use the touchscreen to toggle the **Polarity** between **Positive** and **negative** condition.
5. Use the touchscreen to select the **Limit Range**.
 - **<= (less than a time value)**: Trigger when the positive or negative pulse time of the input signal is lower than the specified time value. For example, for a positive pulse, if you set t (pulse real width) 100ns, the waveform will trigger.



Figure 9.10 Less than a Time Value

- **>= (greater than a time value)**: Trigger when the measured pulse width is less than the specified time. For example, for a positive pulse, if you set the pulse width < 100 ns, the oscilloscope will trigger on the following waveform:



Figure 9.11 Greater than a Time Value

- **[- .- -] (within a range of time value)**: Trigger when the pulse width is between the lower and upper specified times. For example, for a positive pulse, if you set the pulse width) between 100 ns and 300 ns, the oscilloscope will trigger on the following waveform

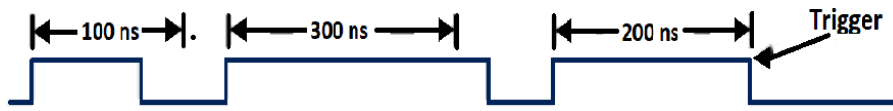

Figure 9.12 Within a Range of Time Value

- **- -][- - (outside a range of time value):** Trigger when the pulse width is greater than the upper limit or lower than the lower limit. This is the logical complement of the previous triggering interval.

The screenshot shows the oscilloscope's trigger menu. The signal source is 'C1'. The trigger type is 'Pulse'. The limit range is set to '- -][- -'. The upper value is 858ns and the lower value is 2.00ns. The holdoff is set to 'None' and the coupling is 'DC'. The main display shows a pulse signal with a width measurement of 60.01622us. The MEASURE table below the display is as follows:

MEASURE	-Width(C1)	No Item	No Item	No Item	No Item
Value	60.01622us				
Mean	60.0162375us				
Min	60.01622us				
Max	60.01625us				
Pk-Pk	0.00003us				
Stdev	12.5ps				
Count	2				

The bottom status bar shows the timebase is 200us/div, the trigger is set to 'Pulse', and the signal is 'C1 DC'.

Figure 9.13 Pulse Trigger Example

Holdoff, coupling, and noise reject can be set in edge trigger, see the sections **Holdoff**, **Trigger Coupling** and **Noise Reject** for more details.

9.2.4 Video Trigger

Video triggering can be used to capture the complicated waveforms of most standard analog video signals. The trigger circuitry detects the vertical and horizontal interval of the waveform and produces triggers based on the video trigger settings you have selected.

The oscilloscope supports standard video signal field or line of NTSC (National Television Standards Committee), PAL (Phase Alternating Line) HDTV (High Definition Television) and custom video signal trigger. To select **Pulse Trigger** type:

1. Press the Setup key or use the touchscreen controls to enter the **Trigger Menu**.
2. Use the touchscreen to select **Type**.
3. The window shown in figure 9.3 will appear.
 - Use the touchscreen to **Video**.
4. Use the touchscreen to select **Standard**, select the desired video standard. (9.2.)

Standard	Type	Sync Pulse
NTSC	Interlaced	BI-level
PAL	Interlaced	BI-level
HDTV 720P/50	Progressive	Tri-level
HDTV 720P/60	Progressive	Tri-level
HDTV 1080P/50	Progressive	Tri-level
HDTV 1080P/60	Progressive	Tri-level
HDTV 1080iP/50	Progressive	Tri-level
HDTV 1080i/50	Progressive	Tri-level
Custom		

Table 9.2 Video Standards

The parameters of **Custom Video Trigger** are shown in table 9.3.

Frame Rate	25 Hz, 30 Hz, 50 Hz, 60 Hz	
Of Lines	300 to 2000	
PAL	1, 2, 4, 8	
HDTV 720P/50	1:1, 2:1, 4:1, 8:1	
Trigger Position	Line	Field
	(line value)/1	1
	(line value)/2	1,2,3,4,5,6,7,8
	(line value)/3	1,2,3,4,5,6,7,8
	(line value)/4	1,2,3,4,5,6,7,8
	(line value)/5	1,2,3,4,5,6,7,8
	(line value)/6	1,2,3,4,5,6,7,8
	(line value)/7	1,2,3,4,5,6,7,8
	(line value)/8	1,2,3,4,5,6,7,8

Table 9.3 Custom Video Trigger Parameters

Line value: The number of lines set in the Of Lines (300 2000).

Table 9.4 explains the relation between **Of Lines**, **Of Fields**, **Interlace**, **Trigger Line** and **Trigger Field** using an **Of Lines** value of 800.

In the custom video trigger type, the corresponding "Of Fields" varies with the selection of the "Interlace" ratio. Therefore, the number of fields selected and the number of lines corresponding to each field can also be varied. If the "Of Lines" is set to 800, the correct relationship between them is as follows:

Of Lines	Of Fields	Interlace	Trigger Line	Trigger Field
800	1	1:1	800	1
800	1, 2, 4 or 8	2:1	400	1, 1~2, 1~4, 1~8
800	1, 2, 4 or 8	4:1	200	1, 1~2, 1~4, 1~8
800	1, 2, 4 or 8	8:1	100	1, 1~2, 1~4, 1~8

Table 9.4 Parameters Relations

5. Press the **Sync** softkey to select **Any** or **Select** trigger mode.

- **Any:** Trigger on any of the horizontal pulses.
- **Select:** Trigger on the appointed line and field you have set.
 - Press the **Line** or **Field** softkey.
 - Turn the **Universal Knob** to set the value.

Table 9.5 list the line numbers per field for each video standard.

Standard	Field 1	Filed 2
NTSC	1 to 263	1 to 262
PAL	1 to 313	1 to 312
HDTV 720P/50, HDTV 720P/60	1 to 750	
HDTV 1080P/50, HDTV 1080P/60	1 to 1125	
HDTV 1080iP/50, HDTV 1080i/60	1 to 563	1 to 562

Table 9.5 Line Numbers Per Field

Triggering on a Specific Line of Video

Video triggering requires greater than 1/2 division of sync amplitude with any analog channel as the trigger source.

The example below is set to trigger on field 2, line 124 using the NTSC video standard.

1. Press the Setup key or use the touchscreen controls to enter the **Trigger Menu**.
2. Use the touchscreen to select **Type**.
3. Press the **Source** option, then use the touchscreen to select **CH 1** as the trigger source.
4. Press the **Standard** option, then select **NTSC** as the trigger source.
5. Press the **Select** option under **Sync**; set the Line to 22.
6. Set the **Field** to **1**.



Figure 9.14 Triggering on a Specific Line of Video

Use a Custom Video Trigger

Custom video triggering supports frame rate of 25Hz, 30Hz, 50Hz and 60Hz, and the line range is available from 300 to 2000. The steps below show how to set custom trigger.

1. Press the **Setup** key on the front panel to open the trigger menu.
2. In the trigger menu, touch the **Type**, and select **Video**.
3. Touch the **Source** and select **CH1** as the trigger source.
4. Touch the **Standard** and select the **Custom**.
5. Touch the **Custom Setting** to open the custom setting menu, touch the **Interlace** to select the required interlace ratio (assuming that the interlace ratio is 8:1). Then set the frame rate, select the number of lines and the number of fields.
6. Touch the **Sync** to select the synchronization mode for the input signal:
 - a. Select the **Any** mode, and the signal can be triggered on any line that meets the trigger condition.
 - b. Select the **Select** mode, then set the specified line and the specified field to trigger the signal. Assuming that the **Field** is set to 8, you can select any field from 1 to 8, and each field can choose any line from 1 to 100.

9.2.5 Window Trigger

Windows trigger provides a high trigger level and a low trigger level. The instrument triggers when the input signal passes through the high trigger level or the low trigger level.

There are two kinds of window types: Absolute and Relative. They have different trigger level adjustment methods.

Under Absolute window type, the lower and the upper trigger levels can be adjusted respectively via the Level knob.

Under Relative window type the Center value is adjusted to set the window center, and the Delta value is adjusted to set the window range. The lower and the upper trigger levels always move together.

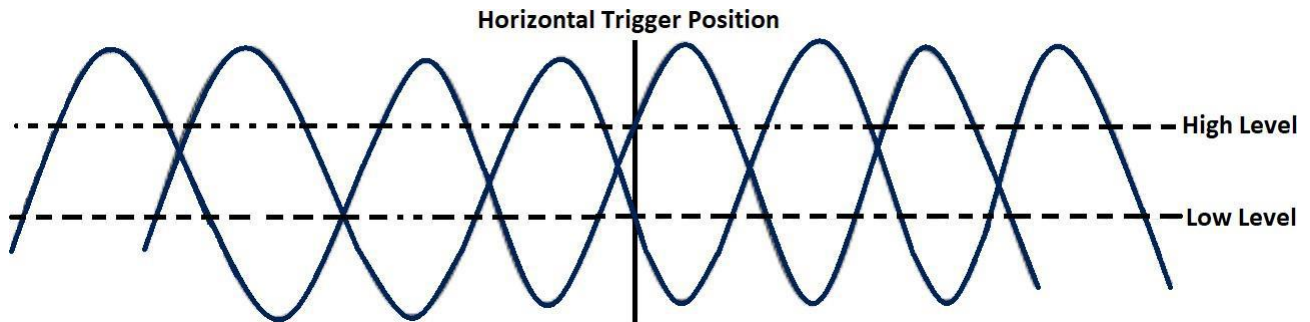

Figure 9.15 Window Trigger

- If the lower and the upper trigger levels are both within the waveform amplitude range, the oscilloscope will trigger on both rising and falling edge.
- If the upper trigger level is within the waveform amplitude range while the lower trigger level is out of the waveform amplitude range, the oscilloscope will trigger on rising edge only.
- If the lower trigger level is within the waveform amplitude range while the upper trigger level is out of the waveform amplitude range, the oscilloscope will trigger on falling edge only.

Set Window Trigger Via Absolute and Relative Window Type

To select **Window Trigger** type:

1. Press the Setup key or use the touchscreen controls to enter the **Trigger Menu**.
2. Use the touchscreen to select **Type**.
3. The window shown in figure 9.3 will appear.
 - Use the touchscreen to select **Window**.
4. Use the touchscreen to toggle the **Window Type** between **Absolute** and **Relative** condition.

When the window trigger type is set to **Relative**, touch the trigger descriptor box. The pop-up menu will show two user-defined parameters: **Level +/-Delta** and **Level Center**.

The above two parameters can be set in the following two ways:

1. Select the parameter in the Level +/-Delta area of the quick menu, then set the parameter value by the virtual keypad or the Level knob on the front panel. Setting the center level is similar.
2. Directly use the Level knob on the front panel. Press the knob to switch between **Level +/-Delta** and **Center Level**, and rotate it to set values.

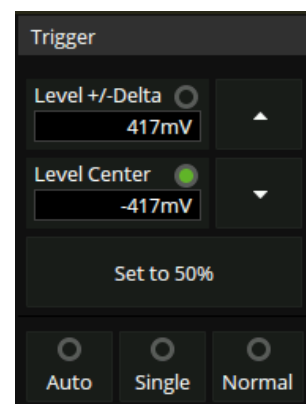

Figure 9.16 Window Trigger Dialog Box

Note:

Level +/-Delta represents half of the actual window area. For example, when the value is 200 mV, it actually represents a range of ± 200 mV, which is a 400 mV window.

Holdoff, coupling, and noise reject can be set in edge trigger, see the sections **Holdoff**, **Trigger Coupling** and **Noise Reject** for more details.

9.2.6 Interval Trigger

Trigger when the times difference between the neighboring rising or falling edges meets the time limit conditions ($< =$, $> =$, [- - . - -], - -] [- -).

When the trigger condition is set as an interval between two neighboring rising edges and it is less than the set time value, the trigger diagram is as follows:

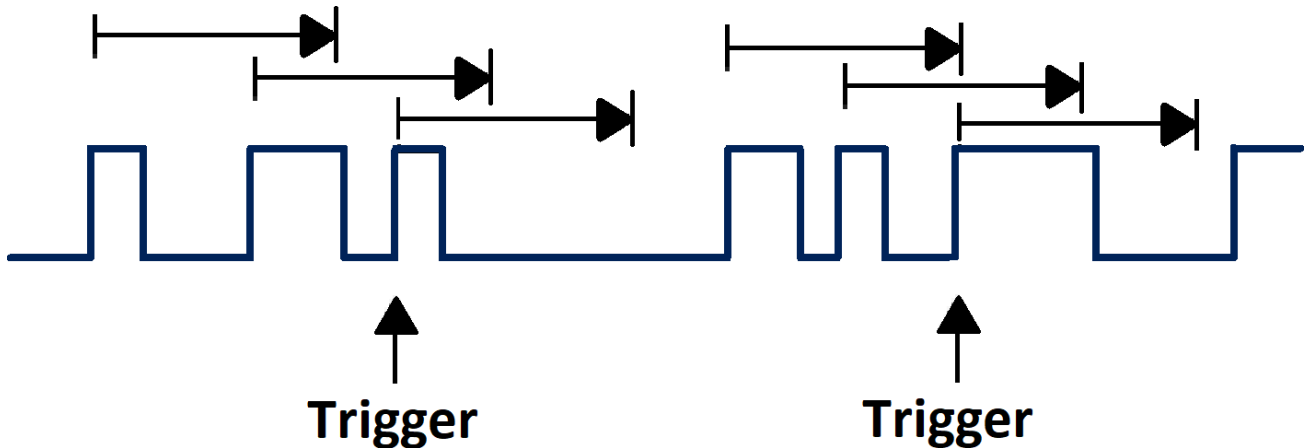

Figure 9.17 Interval Trigger

To select **Interval Trigger** type:

1. Press the Setup key or use the touchscreen controls to enter the **Trigger Menu**.
2. Use the touchscreen to select **Type**.
3. The window shown in figure 9.3 will appear.
 - Use the touchscreen to select **Interval**.
4. Use the touchscreen to toggle the **Slope** between **Rising** and **Falling** condition.
5. Use the touchscreen to select the **Limit Range**.
 - **< = (less than a time value)**: Triggers when the positive or negative pulse time of the input signal is lower than the specified time value.
 - **> = (greater than a time value)**: Triggers when the positive or negative pulse time of the input signal is greater than the specified time value.
 - **[- - . - -] (within a range of time value)**: Triggers when the positive or negative pulse time of the input signal is greater than the specified lower limit of time and lower than the specified upper limit of time value.
 - **- -] [- - (outside a range of time value)**: Triggers when the positive or negative pulse time of the input signal is greater than the specified upper limit of time and lower than the specified lower limit of time value.

Holdoff, coupling, and noise reject can be set in edge trigger, see the sections **Holdoff**, **Trigger Coupling** and **Noise Reject** for more details.

9.2.7 Dropout Trigger

Dropout trigger includes two types: edge and state.

Edge

Triggers when an edge followed by a specified time with no edges is detected. This is useful for triggering on the end of a pulse train.

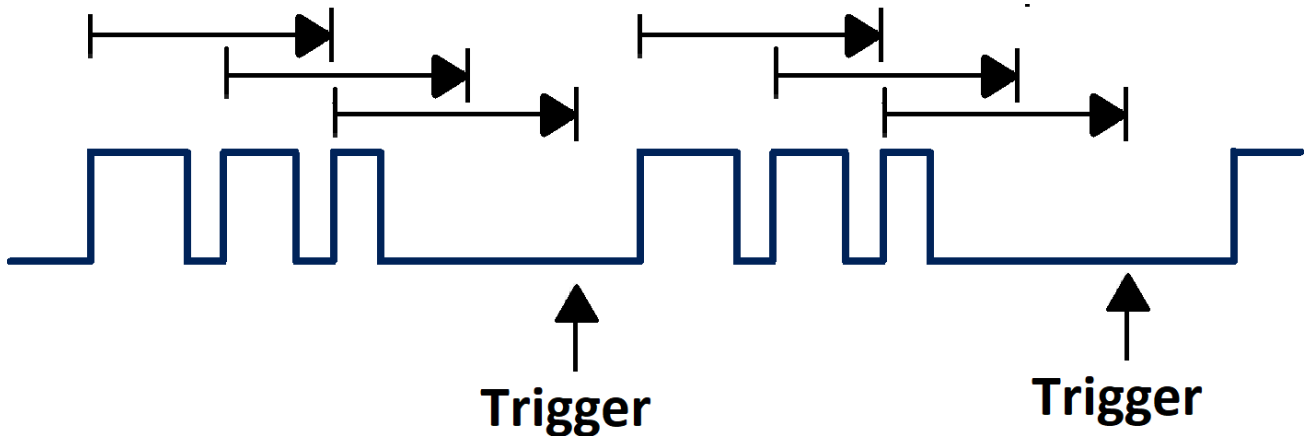

Figure 9.18 Dropout Trigger Edge

To select **Edge Dropout Trigger** type:

1. Press the Setup key or use the touchscreen controls to enter the **Trigger Menu**.
2. Use the touchscreen to select **Type**.
3. The window shown in figure 9.3 will appear.
 - Use the touchscreen to select **Dropout**.
4. Use the touchscreen to set the **Over Time Type** to **Edge**.
5. Use the touchscreen to toggle the **Slope** between **Rising** and **Falling**.

Trigger source, slope (rising, falling), dropout type and time value can be set in the trigger dialog box. Holdoff, coupling, and noise reject can be set in edge trigger, see the sections **Holdoff**, **Trigger Coupling** and **Noise Reject** for more details.

State

Triggers when the signal enters or leaves a voltage level and stays there for a specified time. This is useful for detecting when a signal gets stuck at a particular level.

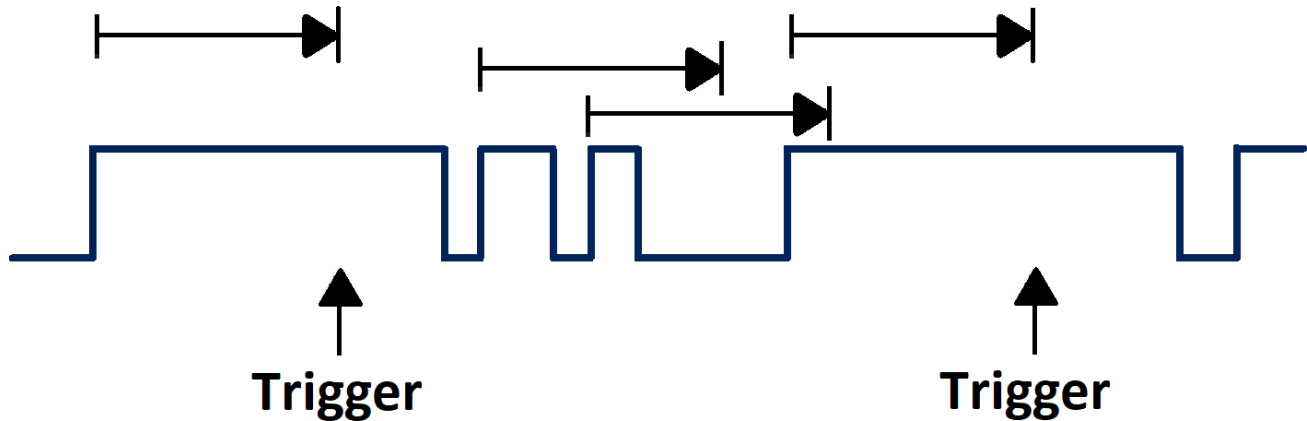

Figure 9.19 Dropout Trigger State

To select **State Dropout Trigger** type:

1. Press the Setup key or use the touchscreen controls to enter the **Trigger Menu**.
2. Use the touchscreen to select **Type**.
3. The window shown in figure 9.3 will appear.
 - Use the touchscreen to select **Dropout**.
4. Use the touchscreen to set the **Over Time Type** to **State**.
5. Use the touchscreen to toggle the **Slope** between **Rising** and **Falling**.

Trigger source, slope (rising, falling), dropout type and time value can be set in the trigger dialog box. Holdoff, coupling, and noise reject can be set in edge trigger, see the sections **Holdoff**, **Trigger Coupling** and **Noise Reject** for more details.

9.2.8 Runt Trigger

The runt trigger detects a pulse that crosses the first threshold but not the second. It can occur when a logic driver has insufficient slew rate to reach a valid logic level in the time available.

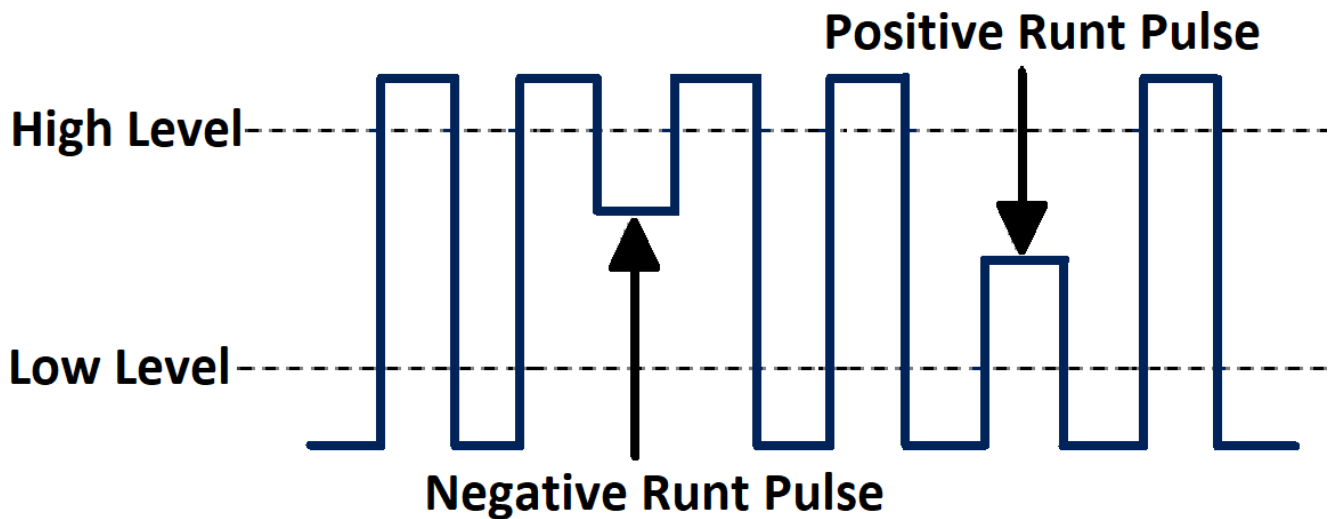

Figure 9.20 Runt Trigger

- A positive runt pulse crosses through a lower threshold but not an upper threshold.
- A negative runt pulse crosses through an upper threshold but not a lower threshold.

To select **Runt Trigger** type:

1. Press the Setup key or use the touchscreen controls to enter the **Trigger Menu**.
2. Use the touchscreen to select **Type**.
3. The window shown in figure 9.3 will appear.
 - Use the touchscreen to select **Runt**.
4. Use the touchscreen to toggle the **Polarity** between **Positive** and **Negative**.
5. Use the touchscreen to select the **Limit Range**.
 - **<= (less than a time value)**: Trigger when the positive or negative slope time of the input signal is lower than the specified time value.
 - **>= (greater than a time value)**: Trigger when the positive or negative slope time of the input signal is greater than the specified time value.
 - **[- . . . -] (within a range of time value)**: Trigger when the positive or negative slope time of the input signal is greater than the specified lower limit of time and lower than the specified upper limit of time value.
 - **- -][- - (outside a range of time value)**: Trigger when the positive or negative slope time of the input signal is greater than the specified upper limit of time and lower than the specified lower limit of time value.

Holdoff, coupling, and noise reject can be set in edge trigger, see the sections **Holdoff**, **Trigger Coupling** and **Noise Reject** for more details.

9.2.9 Pattern Trigger

The Pattern trigger identifies a trigger condition by looking for a specified pattern. The pattern trigger can be expanded to incorporate delays.

Pattern durations are evaluated using a timer. The timer starts on the last edge that makes the pattern “true”. Potential triggers occur on the first edge that makes the pattern false, provided that the time qualifier criterion has been met.

The oscilloscope provides 4 patterns: logical AND, OR, NAND and NOR combination of the channels. Each channel can set to low, high or invalid.

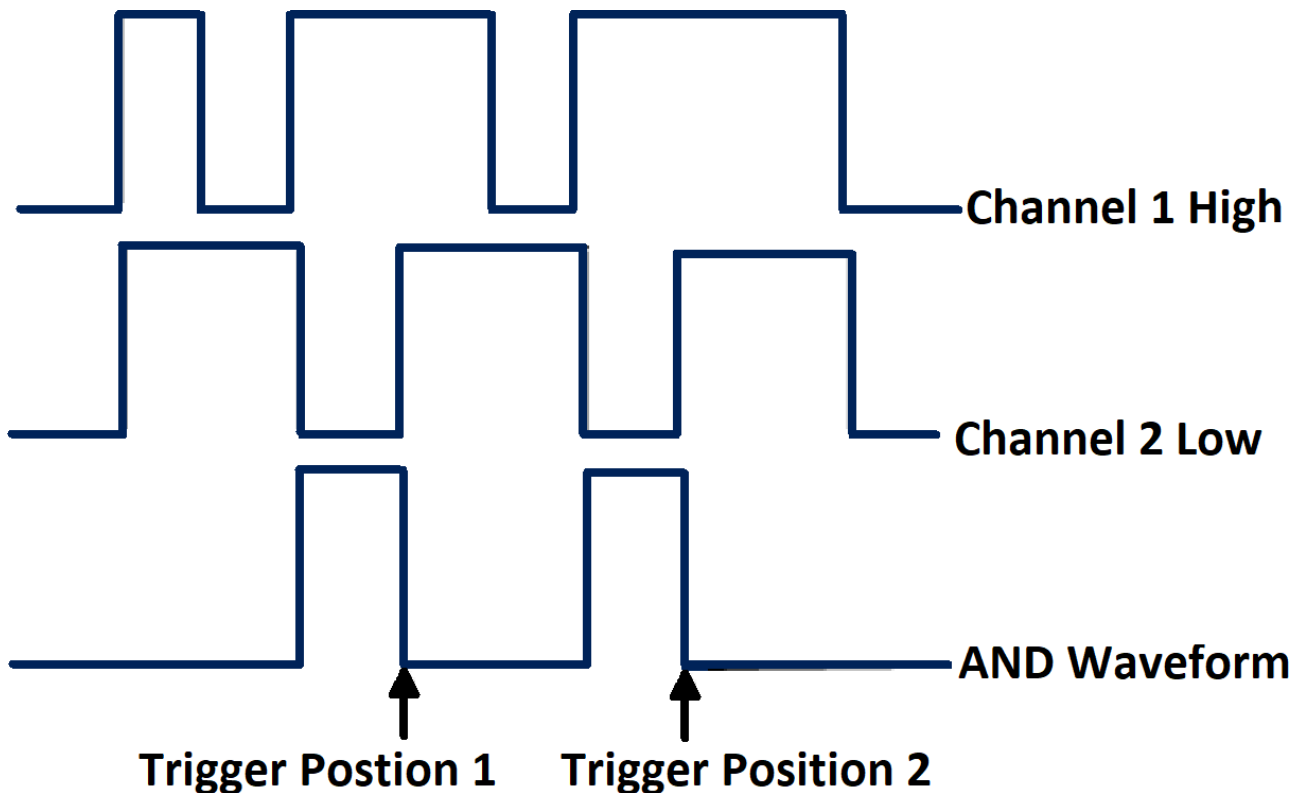
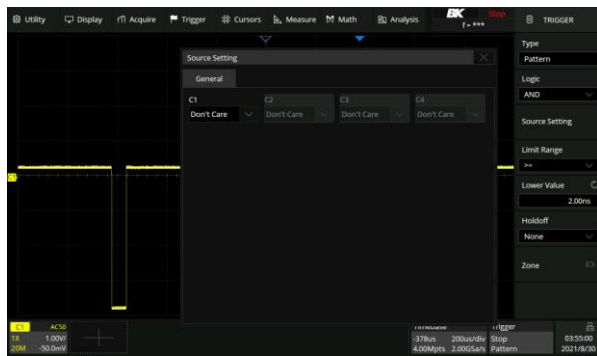

Figure 9.21 Pattern Trigger

To select **Pattern Trigger** type:

1. Press the Setup key or use the touchscreen controls to enter the **Trigger Menu**.
2. Use the touchscreen to select **Type**.
3. The window shown in figure 9.3 will appear.
 - Use the touchscreen to select **Pattern**.
4. Use the touchscreen to select the **Logic** pattern.
5. Press the **Source Setting** to assign one of the following to each channel: **Don't care**, **High** or **Low**.
 - When digital channels are turned on, the logic state of the digital channel can also be set in the source setting dialog box.



Logic Settings of Analog Channels

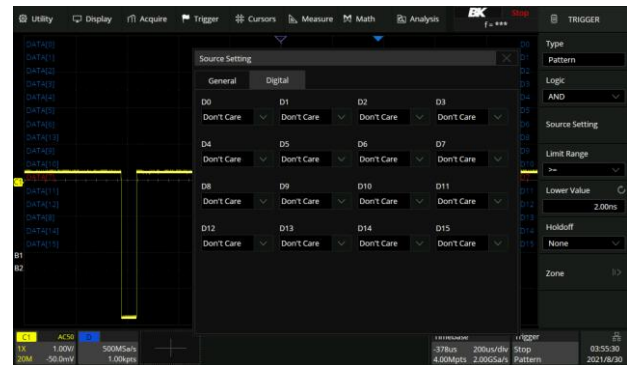

Logic Settings of Digital Channels

Figure 9.22 Source Setting

- **Low:** Sets the pattern to low on the selected channel. A low is a voltage level that is less than the channel's trigger level or threshold level.
 - High sets the pattern to high on the selected channel. A high is a voltage level that is greater than the channel's trigger level or threshold level.
 - Don't care sets the pattern to don't care on the selected channel. Any channel set to don't care is ignored and is not used as part of the pattern.
 - If all channels in the pattern are set to **Don't care**, the oscilloscope will not trigger.
6. Use the touchscreen to select the **Limit Range**.
- When the logic is **AND** or **NOR**, the time limit condition is available. This setting is particularly useful to filter the hazard signals of combinational logic.
 - When the logic is **OR** or **NAND**, the time limit setting is not supported.

Holdoff, coupling, and noise reject can be set in edge trigger, see the sections **Holdoff**, **Trigger Coupling** and **Noise Reject** for more details.

9.3 Trigger Mode

The oscilloscope's trigger mode includes Auto, Normal, and Single. Trigger mode affects the way in which the oscilloscope searches for the trigger.

After the oscilloscope starts running, the oscilloscope operates by first filling the pre-trigger buffer. It starts searching for a trigger after the pre-trigger buffer is filled and continues to flow data through this buffer while it searches for the trigger. While searching for the trigger, the oscilloscope overflows the pre-trigger buffer and the first data put into the buffer is first pushed out (First Input First Out, FIFO).

When a trigger is found, the pre-trigger buffer contains the events that occurred just before the trigger. Then, the oscilloscope fills the post-trigger buffer and displays the acquisition memory.

To select the trigger mode, press the key corresponding to the desired mode.

Auto

If the specified trigger conditions are not found, the triggers are forced and acquisitions are made so that signal activity is displayed on the oscilloscope.

Auto trigger mode is appropriate when:

- Checking DC signals or signals with unknown levels or activity.
- When trigger conditions occur often enough that forced triggers are unnecessary.

Normal

Triggers and acquisitions only occur when the specified trigger conditions are found. Otherwise, the oscilloscope holds the original waveform and waits for the next trigger.

Normal trigger mode is appropriate when:

- Only specific events specified by the trigger settings are to be acquired.
- Triggering on an infrequent signal from a serial bus such as I2C, SPI, CAN, LIN, etc. or another signal that arrives in bursts.

Note:

Normal trigger mode stabilizes the display by preventing the oscilloscope from auto-triggering.

Single

The oscilloscope waits for a trigger and displays the waveform when the trigger condition is met, the acquisition is stopped when the trigger conditions are met.

Single trigger mode is appropriate when:

- Capturing a single event or a periodic signal.
- Capturing a burst or other unusual signals.

Note:

The oscilloscope can be forced to trigger by pressing the Single button twice. The trigger status in the upper right corner of the screen will be displayed as "Stop".

9.4 Trigger Level

Trigger level and slope define the trigger point.

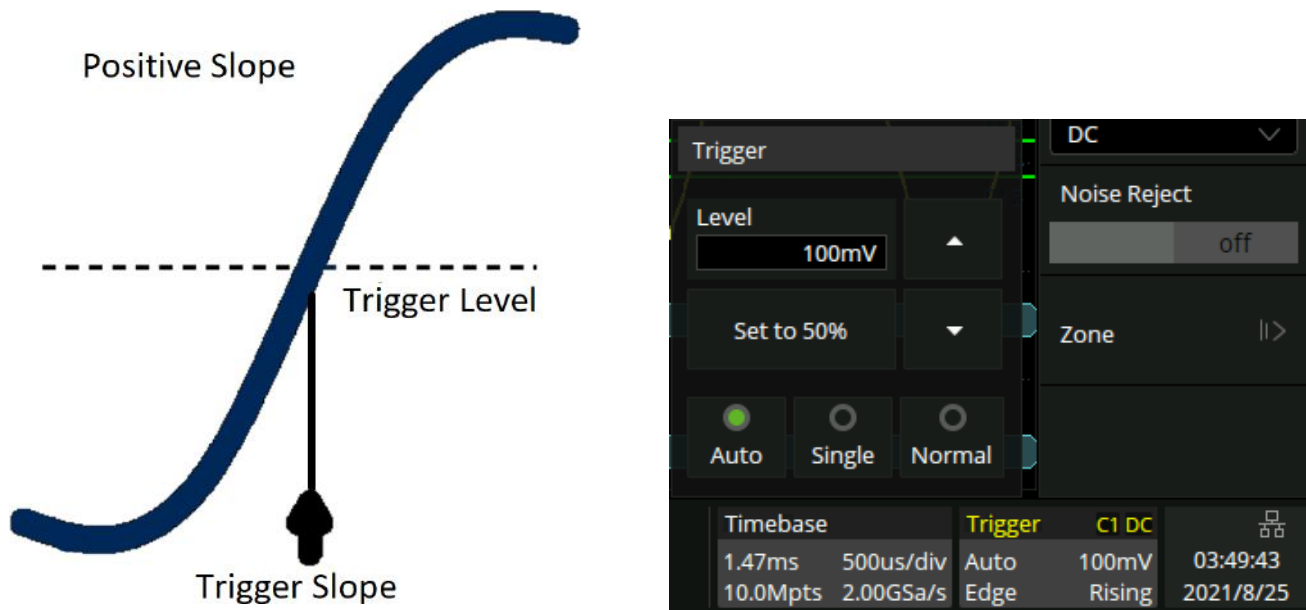



Figure 9.23 Trigger Point

To set the trigger level:

- Use the touchscreen controls to open the **Trigger** dialog by pressing the trigger descriptor box.



Figure 9.24 Trigger Descriptor Box

- Press the **Level** box to set the trigger level by the virtual keypad. (Figure ??)
- Press  to increase and  to decrease the trigger level scale.

The position of the trigger level for the analog channel is indicated by the trigger level icon  (if the analog channel is on). The value of the analog channel trigger level is displayed in the upper-right corner of the trigger descriptor box.

The example in figure 9.23 highlights the Positive edge slope at a trigger level of 100 mV.

9.5 Trigger Coupling

Trigger coupling is only valid when the trigger source is set to an analog channel, EXT or EXT/5.

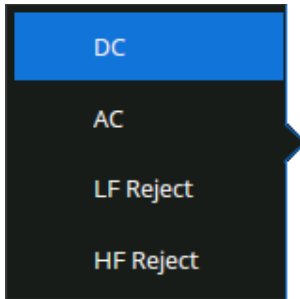

To set the trigger coupling:

1. Press the Setup key or use the touchscreen controls to enter the **Trigger** menu.
2. Use the touchscreen controls to select the **Coupling** option.
 - The window shown in figure 9.25 will appear.
3. Use the touchscreen controls to select the desired coupling.

Figure 9.25 Trigger Coupling

Note:

Trigger coupling is separate from channel coupling.

The oscilloscope provides 4 kinds of trigger coupling modes:

DC

Allows both AC and DC components of the waveform into the trigger path.

AC

Blocks all the DC components and attenuate signals lower than 8 Hz. Use AC coupling to get a stable edge trigger when your waveform has a large DC offset.

LF Reject

The signal is coupled through a capacitive high-pass filter network, DC is rejected and low frequencies are attenuated. For stable triggering on medium to high-frequency signals. See the Specifications for details of the cut-off frequency.

HF Reject

Signals are DC coupled to the trigger circuit and a low-pass filter network attenuates high frequencies (used for triggering on low frequencies). See the Specifications for details of the cut-off frequency.

9.6 Trigger Holdoff

Trigger holdoff can be used to add an additional, user-defined delay to the re-arming of the trigger circuit. This provides control over how rapidly, or how often, the oscilloscope can be triggered. The oscilloscope will not trigger until the holdoff time expires.

Use the holdoff to trigger on repetitive waveforms that have multiple edges (or other events) between waveform repetitions. You can also use holdoff to trigger on the first edge of a burst when you know the minimum time between bursts.

9.6.1 Holdoff by Time

Holdoff time is the amount of time that the oscilloscope waits before rearming the trigger circuitry. The oscilloscope will not trigger until the holdoff time expires.

Use the holdoff to trigger on repetitive waveforms that have multiple edges (or other events) between waveform repetitions. You can also use holdoff to trigger on the first edge of a burst when you know the minimum time between bursts.

For example, to achieve a stable trigger on the repetitive pulses shown in the figure below set the holdoff time (t) to $200 \text{ ns} < t < 400 \text{ ns}$.

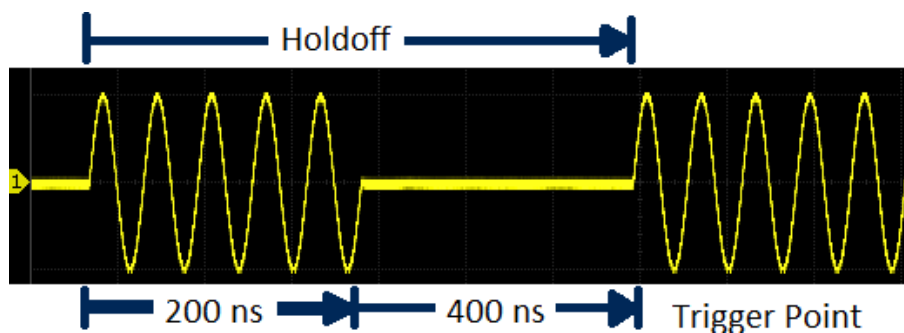

Figure 9.26 Holdoff

9.6.2 Holdoff by Event

The holdoff event is the number of events that the oscilloscope counts before re-arming the trigger circuitry. The oscilloscope will not trigger until the counter tracking holdoff events reaches the set value.

Finding the Repetition of a Waveform

To find the repetition of the waveform:

1. Press the Stop key to stop data acquisition.
2. Turn the Horizontal Position Knob and the Horizontal Scale Knob to find where the waveform repeats.
3. Measure the time using the cursors function.
4. Set the **Holdoff** time.

Setting Holdoff

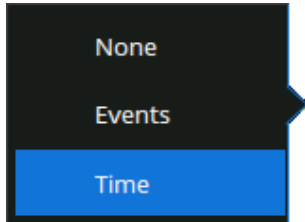

Figure 9.27 Trigger Holdoff

To set the trigger Holdoff:

1. Press the Setup key or use the touchscreen controls to enter the **Trigger** menu.
2. Use the touchscreen controls to select the **Holdoff** option.
 - The window shown in figure 9.27 will appear.
3. Use the touchscreen controls to select the desired Holdoff.
4. Use the touchscreen controls to select **Holdoff Events** or **Holdoff Time** depending on the trigger holdoff that was selected.

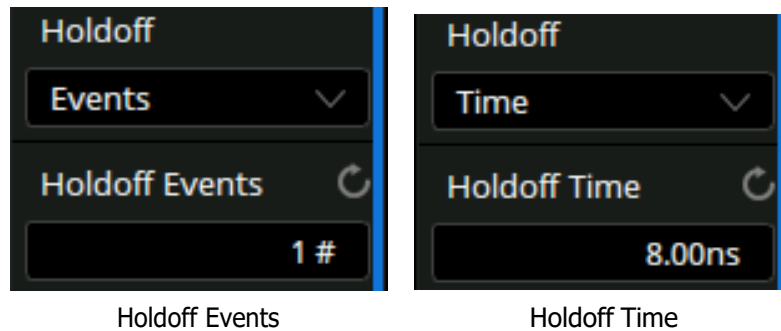

Figure 9.28 Trigger Holdoff

- The holdoff events of the oscilloscope is adjustable from 1 to 100000000 events.
 - The holdoff time of the oscilloscope is adjustable from 8 ns to 30 s.
5. Use the virtual keypad or the **Universal knob** to adjust the number of hold-off events or the holdoff time.

Note:

Adjusting the time scale and horizontal position will not affect the holdoff time.

9.6.3 Start Holdoff On

Start Holdoff On defines the initial position of holdoff.

The 2560B series offers the following start holdoff on options:

Acq Start: The initial position of holdoff is the first time point satisfying the trigger condition. In the example above, each holdoff starts from the first rising edge of the pulse sequence.

Last Trig Time: The initial position of holdoff is the time of the last trigger. In the example above, the last trigger position is at the second rising edge of the pulse sequence and the second holdoff starts from that point.

Setting Start Holdoff On

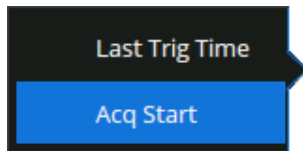

Figure 9.29 Start Holdoff On

To set the start holdoff on:

1. Press the Setup key or use the touchscreen controls to enter the **Trigger** menu.
2. Use the touchscreen controls to select the **Start Holdoff On** option.
 - The window shown in figure 9.29 will appear.
3. Use the touchscreen controls to select the desired start holdoff on.

9.7 Noise Reject

Noise Rejection adds additional hysteresis to the trigger circuitry. By increasing the trigger hysteresis band, the possibility of triggering on noise is decreased, however the trigger sensitivity is also decreased. A larger signal is required to trigger the oscilloscope when **Noise Rejection** is enabled.

To enable **Noise Rejection**:

To set the start holdoff on:

1. Press the Setup key or use the touchscreen controls to enter the **Trigger** menu.
2. Use the touchscreen controls to select the **Noise Reject** option.
 - Tapping **Noise Reject** will toggle between the on and off mode.



Disabled

Enabled

Figure 9.30 Noise Reject

If the signal being probed is noisy, set up the oscilloscope to reduce the noise in the trigger path and on the displayed waveform. First, stabilize the displayed waveform by removing the noise from the trigger path. Second, reduce the noise on the displayed waveform.

- Obtain a stable display.
- Remove the noise from the trigger path setting Trigger coupling to **LF Reject**, **HF Reject**, or enabling **Noise Reject**.
- Set the Acquisition mode to **Average** to reduce noise.

9.8 Zone Trigger

The 2560B Series includes a zone trigger to help isolate elusive glitches. There are two user-defined areas: Zone1 and Zone2. The property of each zone as **intersect** or **not intersect** as an additional condition to further isolate an event. **Intersect** only includes events that occur within the zone. **Not intersect** includes all events that occur outside of the zone.

To enable and the trigger zone function:

1. Press the Setup key or use the touchscreen controls to enter the **Trigger Menu**.
2. Use the touchscreen to select **Zone** .
3. The menu shown in figure 9.32 will appear.
4. Press the **Zone** option to toggle the zone function on or off.

9.8.1 Creating and Moving Zones

The zones can be created and moved by gestures or by setting the zone settings in the Zone Setting Menu. The color of the zone's outline is consistent with the color of the specified source.(Channel 1 = Yellow, etc.)

Gestures

When the zone trigger is turned on , touch-and-hold on any position within the waveform area and draw a rectangular box, as shown in figure 9.31.

When the finger moves out of the screen, a menu pops up for selecting the zone and setting the zone properties:

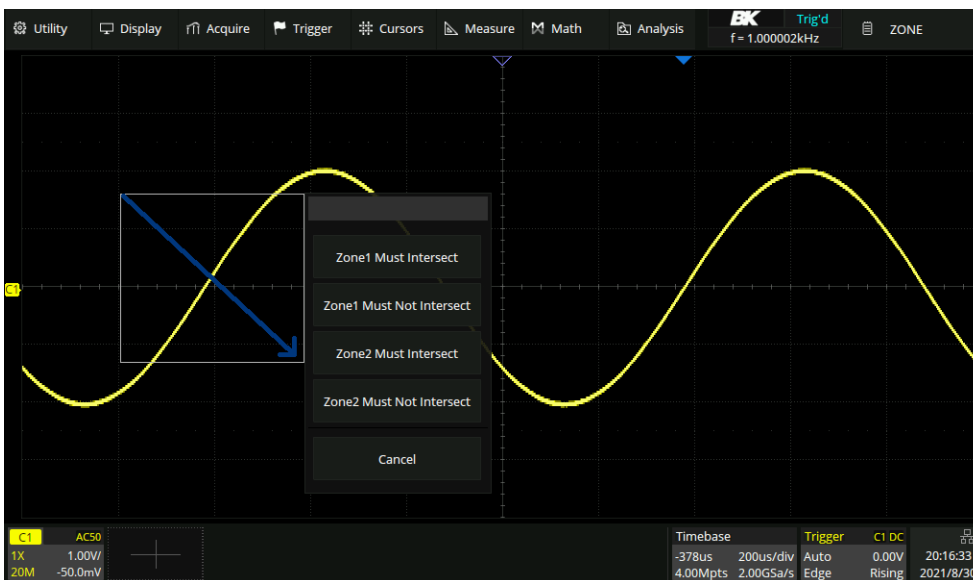

Figure 9.31 Zone Gesture

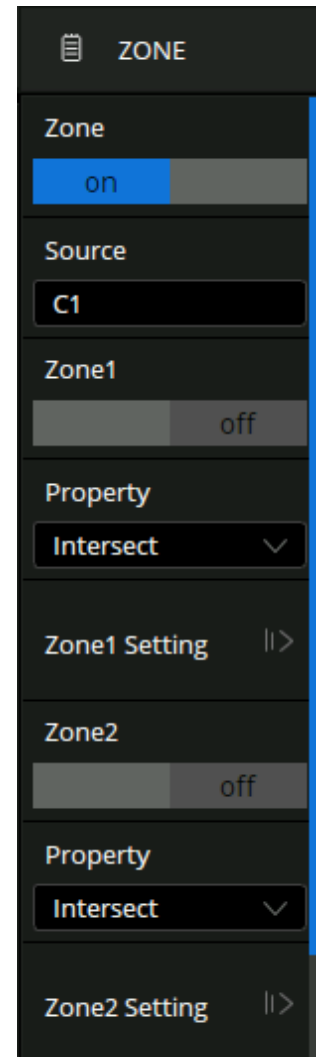

Figure 9.32
Zone Trigger Menu

Once a zone is created, it can be moved by dragging. Touch and hold the zone box and use a dragging gesture to reposition the zone.



Figure 9.33 Intersect Zone

Select C1 as the source, turn on zone1, and set the property as **Intersect**.

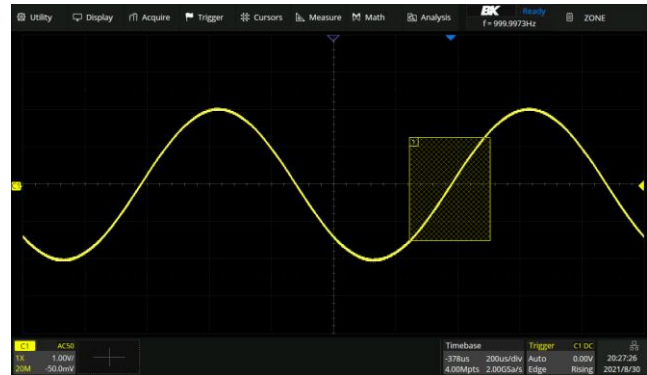

Figure 9.34 Not Intersect Zone

Change **Intersect** to **Not Intersect** and use the drag gesture to reposition the zone.

Menu Configuration



Figure 9.35
Region Setting

Zones can be also be configured using the **Region Setting** dialog box.

To configure the zone from the menu:

1. Press the Setup key or use the touchscreen controls to enter the **Trigger Menu**.
2. Use the touchscreen to select **Zone**.
3. The menu shown in figure 9.32 will appear.
4. Press the **Zone1 Setting** option to configure zone 1 or press the **Zone2 Setting** option to configure zone 2.
5. The **Region Setting** menu shown in figure 9.35 allows for adjustments of the available axes.

The axis value can be set using the virtual keypad or the **Universal Knob**.

Note:

If zone1 and zone2 are both turned on, the result of the "AND" operation in two zones becomes the qualifying condition of triggering.

Figure 9.37 demonstrates an example in which a waveform of bus contention is captured. With a simple edge trigger, it is unlikely to trigger consistently on this anomaly.

Enabling the persistence display, allows the verification of bus contention occurring as shown in figure 9.36.



Figure 9.36 Persistence Enabled

Using the zone trigger is a quick and simple way to capture the interesting waveform.

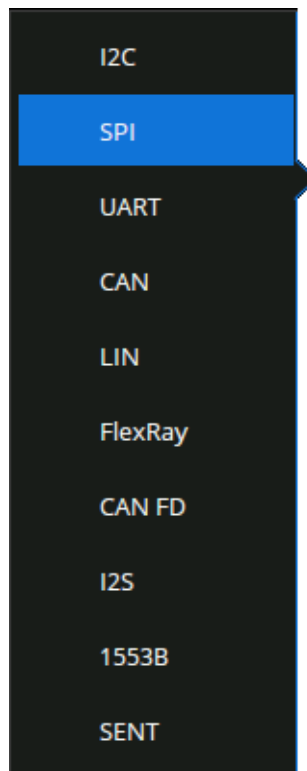

Figure 9.37 Bus Waveform

Serial Trigger and Decode

The 2560B series supports serial bus triggering and decoding on the following serial bus protocols: **I2C, SPI, UART, CAN and LIN** and also support optional **FlexRay, CAN FD, I2S, MIL-STD-1553B, SENT and Manchester**.

This chapter introduces the method of triggering and decoding these serial signals in details.



To select **Serial Trigger** type:

1. Press the Setup key or use the touchscreen controls to enter the **Trigger Menu**.
2. Use the touchscreen to select **Type** .
3. The window shown in figure 9.3 will appear.
 - Use the touchscreen to select **Serial**.
4. Use the touchscreen to select **Protocol**.
 - The dropdown menu shown in figure 10.1 will appear.
5. Select the desired bus protocol.

To select the decoding **Bus Protocol**:

1. Press the Decode key or use the touchscreen controls to enter the **Decode Menu**.
2. Use the touchscreen to enable **Bus Operation**.
3. Use the touchscreen to select **Bus Protocol**.
4. The window shown in figure 10.1 will appear with the addition of the **Manchester** protocol.
5. Select the desired bus protocol.

Figure 10.1
Bus Protocols

10.1 I2C Trigger and Serial Decode

10.1.1 Setup for I2C Signals

To set the I2C (Inter-IC bus) signal first, connect the serial data signal (SDA) and serial clock signal (SCL) to oscilloscope. Set the mapping relation between channels and signals and then set the threshold level of each signal.

To set I2C decoding:

1. Press the Decode key to enter the **Decode** menu.
2. Use the touchscreen to press the **Bus Protocol** option and select **I2C**.
3. Use the touchscreen to press the **Protocol Signals** option.
 - The **I2C Signal** menu shown in figure 10.2 will be displayed.

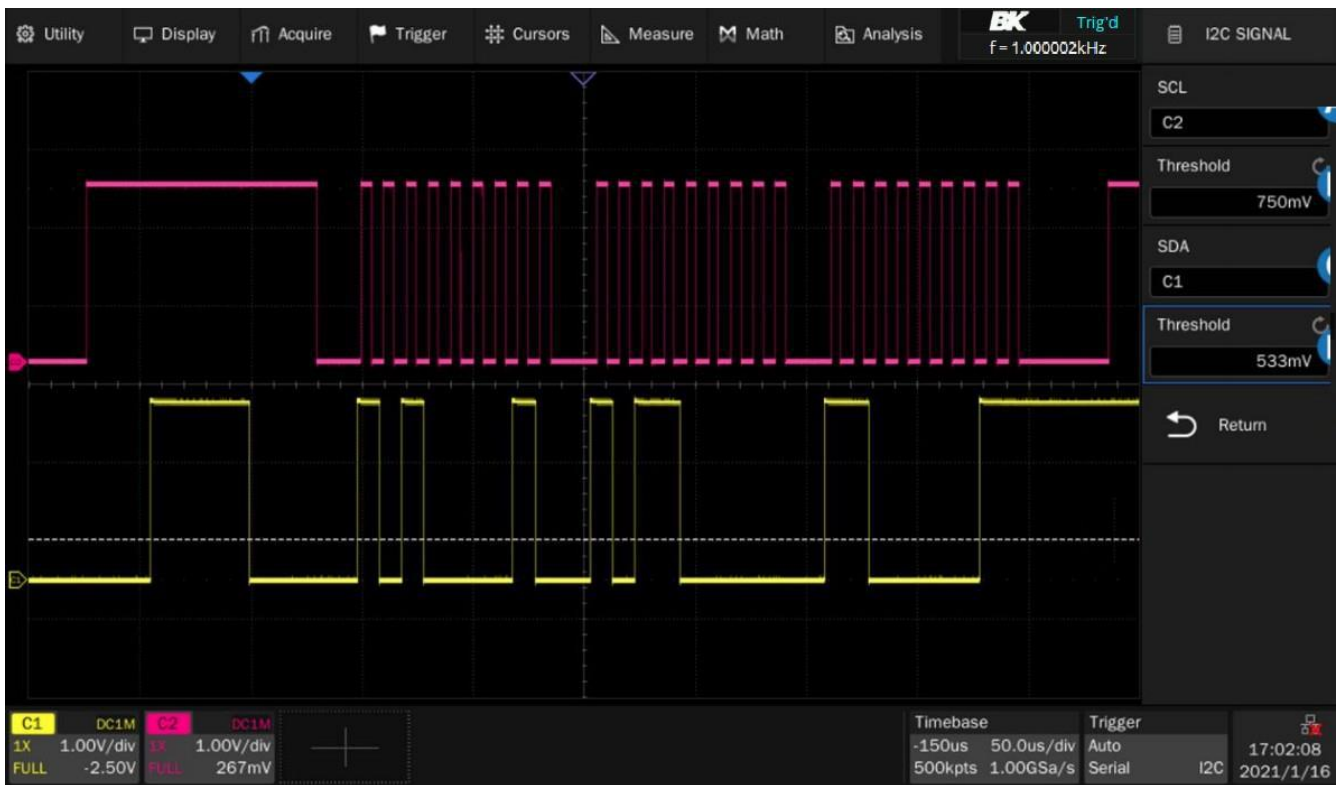



Figure 10.2 I2C Signal Menu

4. Set the source of SCL. In the example shown in figure 10.2, SCL is connected to C2.
5. Set the threshold level of SCL. It is 750 mV for the LVTTTL signal in this example.
6. Set the source of SDA. In the example above, SDA is connected to C1.
7. Set the threshold level of the SDA channel.
 - The threshold voltage level is for decoding, and it will be regarded as the trigger voltage level when the trigger type is set to serial.
 - Threshold level line. It only appears when adjusting the threshold level.
8. Touch  option to return previous menu.

The signal settings of decoding and triggering are independent. To synchronize the settings between decode and trigger, perform the **Copy Setting** function in the **Decode** menu.

1. Touch **Protocol Copy** in the Decode menu to synchronize the settings between the trigger and decoding configurations.
2. Copy the decode settings to trigger.
3. Copy the trigger settings to decode.
4. Touch  option to return previous menu.

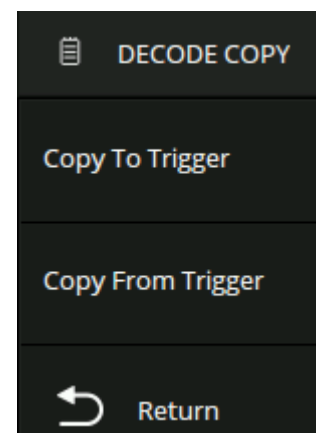

Figure 10.3
Decode Setting Menu

10.1.2 I2C Trigger

The I2C trigger has nine trigger conditions: (**Start, Stop, Restart, No Ack, EEPROM, 7 Addr&Data, 10 Addr&Data and Data Length**)

- **Start Condition:** The oscilloscope will be triggered when the SDA signal transitions from high to low while the SCL clock is high. If it is chosen as the condition of trigger (including frame triggers), a restart will be treated as a "Start condition".
- **Stop Condition:** The oscilloscope will be triggered when SDA transitions from low to high while the SCL is high.

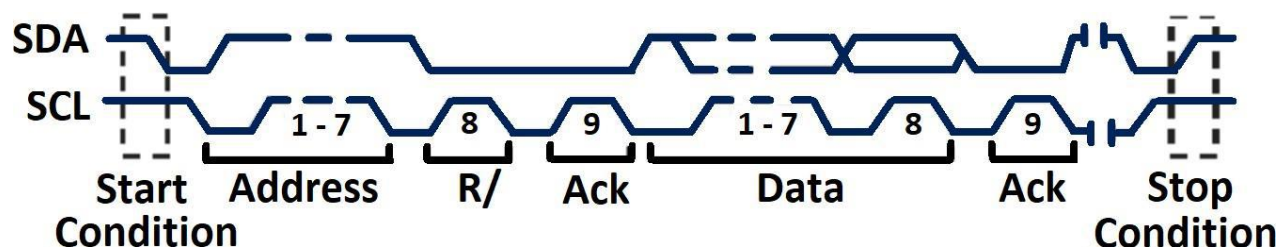

Figure 10.4 Start and Stop Conditions

- **Restart:** The oscilloscope will be triggered when another "Start condition" occurs before a "Stop condition".
- **No Ack:** The oscilloscope will be triggered when SDA data is high during any SCL's ACK bit.
- **EEPROM:** The trigger searches for EEPROM control byte (the value is 1010xxx) on the SDA bus where there is a Read bit and an ACK bit behind EEPROM.
 - Use the **Limit Range** to set the qualifier.
 - Use the **Data1** to set the data's value.

Note:

If EEPROM's data is greater than Data1, the oscilloscope will be triggered at the edge of ACK bit behind Data byte. It's unnecessary that the Data byte must follow the EEPROM.

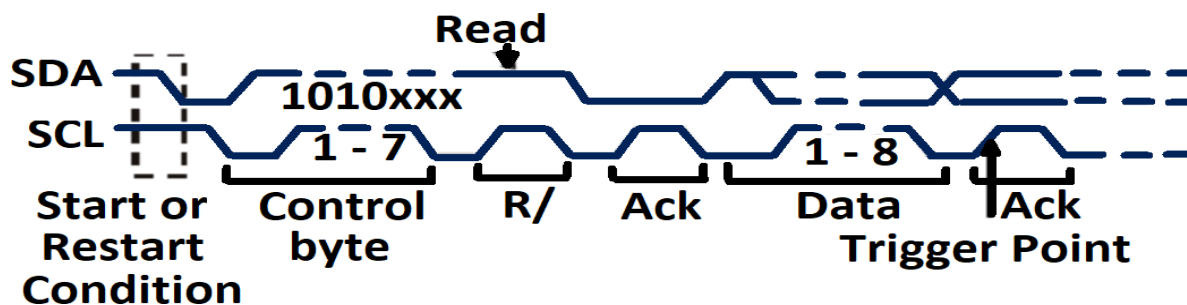

Figure 10.5 Trigger Point

- **7 address & Data:** The oscilloscope will be triggered when the following conditions are satisfied:
 - The address's length must be 7 bits and the address's value must be the same as the set value.
 - Data1's or Data2's value is set to the same value of the signal's data.
 - Both Data1's and Data2's values are set and the signal has two consecutive data values, the first is value is Data1 and the second data value is Data2.

Note:

If the data's value is 0xXX, any data value will be matched.

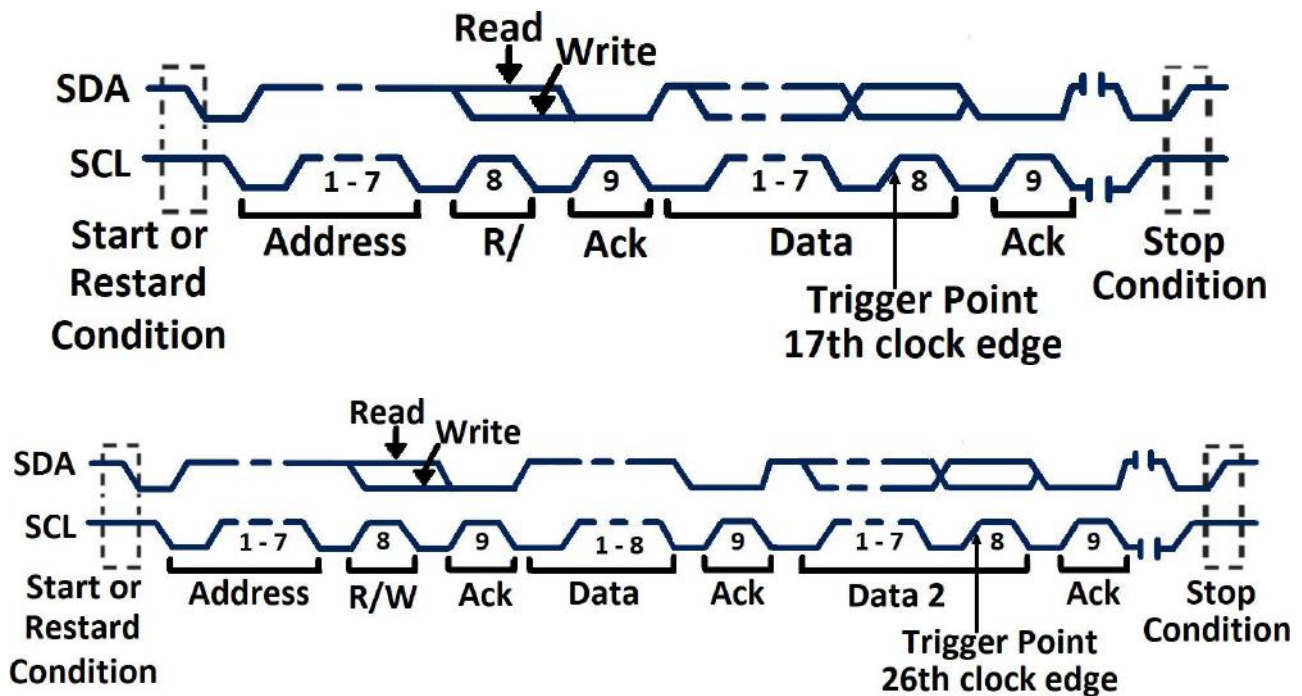

Figure 10.6 7 Address & Data

- **10 address & Data:** The oscilloscope will be triggered when the following conditions are satisfied:
 - The address's length must be 10 bits and the address's value must be the same as the set value.
 - Data1's or Data2's value is set to the same value of the signal's data.
 - Both Data1's and Data2's values are set and the signal has two consecutive data values, the first is value is Data1 and the second data value is Data2.
 - R/W can be specified as Write, Read, or Don't Care.

Note:

If the data's value is 0xXX, any data value will be matched.

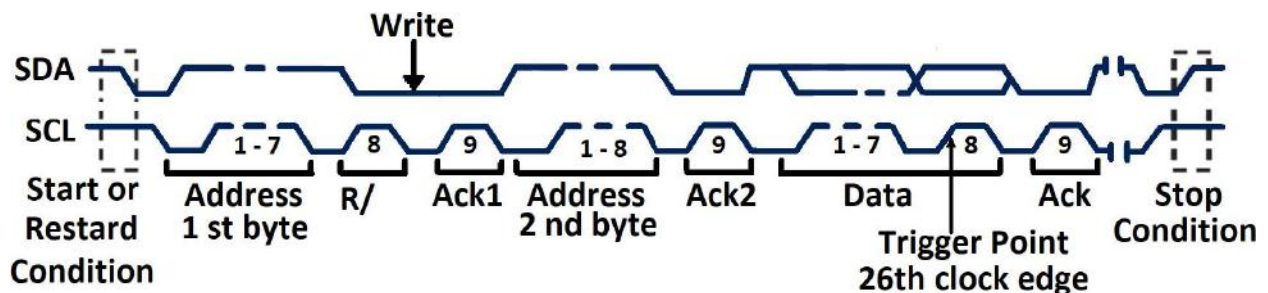

Figure 10.7 10 Address & Data

- **Data Length:** When SDA data's length is equal to the value of Byte Length and address's length is the same as set value, the oscilloscope will be triggered. Byte length is in the range of 1 to 12 bits.

Operation Step

1. Touch Setup key or use the touchscreen controls to enter the **Trigger Menu**.
2. Use the touchscreen to select **Type**.
3. The window shown in figure 9.3 will appear.
 - Use the touchscreen to select **Serial**.
4. Use the touchscreen to select **Protocol**.
 - The dropdown menu shown in figure 10.1 will appear.
5. Use the touchscreen to select **I2C** protocol.
6. Use the touchscreen to select **Trigger Setting**.
7. Use the touchscreen to select **Conditions**.
 - The dropdown menu shown in figure 10.8 will be displayed.
 - Select the desired condition.

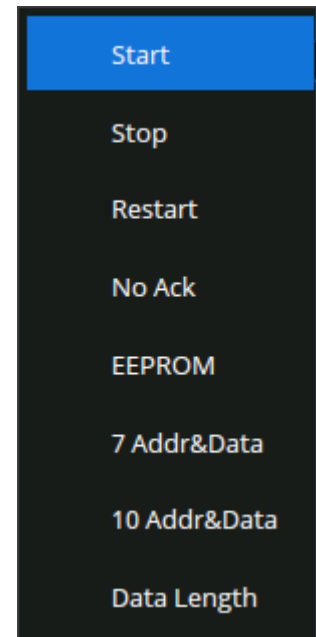

Figure 10.8
I2C Conditions

- If EEPROM is selected :
 - Touch **Limit Range** option to set the qualifier (**=, < or >**).
 - Touch **Data1** and set its value by turning the **Universal Knob** or using the virtual keypad.
- If 7 Addr & Data or 10 Addr & Data is selected:
 - Touch **Addr** option and turn the **Universal Knob** to select the 7- bit or 10- bit device address.
 - Touch **Data1** or **Data2** and set the value.
 - Touch **R/W bit** and select write-frame or read-frame to trigger the oscilloscope.

Note:

If the device's address is 7-bit, the value of address is in range of 0x00 to 0x7F. If device's address is 10-bit, the value of address is in range of 0x00 to 0x3FF.

- If **Data Length** is selected:
 - Touch **Address** to set the SDA address length 7bit or 10 bit.
 - Touch **Byte Length** and set the byte length by **Universal Knob**. The range of the Byte Length is 1 to 12.

10.1.3 I2C Serial Decode

Once the setup for the I2C signal and trigger has been completed, the decoding operation must be setup.

1. Touch Decode key to display the **Decode** menu.
2. Use the touchscreen to enable the **Bus Operation**.
3. Touch **Bus** option to select either **Bus1** or **Bus2**.
4. Touch **Display** option to select the character encoding format of the decoding's result.
 - The bus's vertical position can be adjusted using the **Universal Knob** after selecting **Bus Position**.
5. Touch  to return to the **Decode** menu.
6. Touch **Display** option and choose the bus option selected in step 3.
7. Touch **Lines** options and set the number of lines by **Universal Knob** or the virtual keypad.
 - The range of the lines is 1 to 7.
8. Touch **Scroll** option and turn the Universal Knob to navigate the available lines.

Interpreting the I2C Decode

The frames of decoding result:

- The address value is displayed at the beginning of a frame. The write address is displayed in green, and the read address is displayed in yellow.
- W/R bit is represented by (W) and (R), following the address value.
- The data value is displayed in white.
- "~A" after a data or address bits indicates no acknowledgement. For example, DB~A.
- A red dot indicates there is not enough space on the display to show the complete content of a frame.



Figure 10.9 I2C Decode Bus Display

The lists of decoding result:

- **Time:** The horizontal displacement between current frame and trigger position.
- **Address:** The address of a frame.
- **R/W:** The type of a frame (write or read).
- **Data:** The value of data.





I2C	Time	Address	R/W	Data
1	2.01300us	0x2AB	W	
2	192.003us	0x2AB	R	0x4E 54 5F 80 00 58 D8~A

Figure 10.10 Decode List Display

10.2 SPI Trigger and Serial Decode

10.2.1 Setup for SPI Signals

Setting the SPI (Serial Peripheral Interface) signal includes two steps: Connecting the CLK, MISO, MISO and CS signal to oscilloscope, specifying the parameters of each input signal.

1. Touch **Decode** key to enter the **Decode** menu.
2. Touch **Decode** and select the desired slot (**Decode1** or **Decode2**).
3. Touch **Protocol** to display the available SPI Signals.
4. Set CLK (clock signal):
 - Touch **CLK** to enter CLK menu.
 - Touch **CLK** to select the channel that is connected to the SPI clock signal.
 - Touch **Threshold** to set the SPI clock signal's threshold voltage level by Universal Knob.
 - The threshold voltage level is for decoding, and it will be regard as the trigger voltage level when set the trigger type to serial.
 - Touch **Edge Select** to set the oscilloscope will samples at clock signal's rising edge or falling edge.
 - Touch  to return previous menu.
5. Set MISO:
 - Touch **MISO** to enter the **MISO** menu.
 - Touch **MISO** to select the channel that is connected to the SPI MISO signal.
 - Touch **Threshold** softkey, then use the **Universal Knob** to set the SPI MISO signal's threshold voltage level.
 - The threshold voltage level is for decoding, and it will be regard as the trigger voltage level when set the trigger type to serial.
 - Touch  to return to the previous menu.
6. Set MOSI:
 - Press the **MOSI** to enter the MOSI menu.
 - Touch **MOSI** to select the channel that is connected to the SPI MOSI signal.
 - Press the **Threshold** softkey, then use the **Universal Knob** to set the SPI MOSI signal's threshold voltage level.
 - The threshold voltage level is for decoding, and it will be regarded as the trigger voltage level when the trigger type is set serial.
 - Touch  to return to the previous menu.
7. Set CS:
 - Touch **CS** to enter the MOSI menu.
 - Touch **CS Type** to select the chip select type.
 - Modify the CD value.
 - Touch  to return to the previous menu.

Function Menu	Settings	Description
CS Type	~CS	Low voltage level of CS signal is available
	CS	High voltage level of CS signal is available
	CLK Timeout	If the time between two edges of the clock signal is less than (or equal to) the value of timeout, the signal between the two edges is treated as a frame. The range of clock timeout is 100 ns - 5 ms. This setting is suitable for case where the CS signal is not connected, or the number of oscilloscope channels is insufficient (such as 2-channel oscilloscopes).

Table 10.1 CS Type Parameters

Example

Connect the data, CLK and ~CS signals of a SPI bus respectively to C1, C2, and C3. Data width = 8-bit, Bit order = MSB, CS polarity = CS, and 12 data bytes are transmitted in one frame.

In the SPI trigger signal menu, set the source and threshold of CLK, MISO and CS signals, then copy the trigger settings to decoding. Adjust the timebase, so that the falling edge of the CS signal is shown in the display:

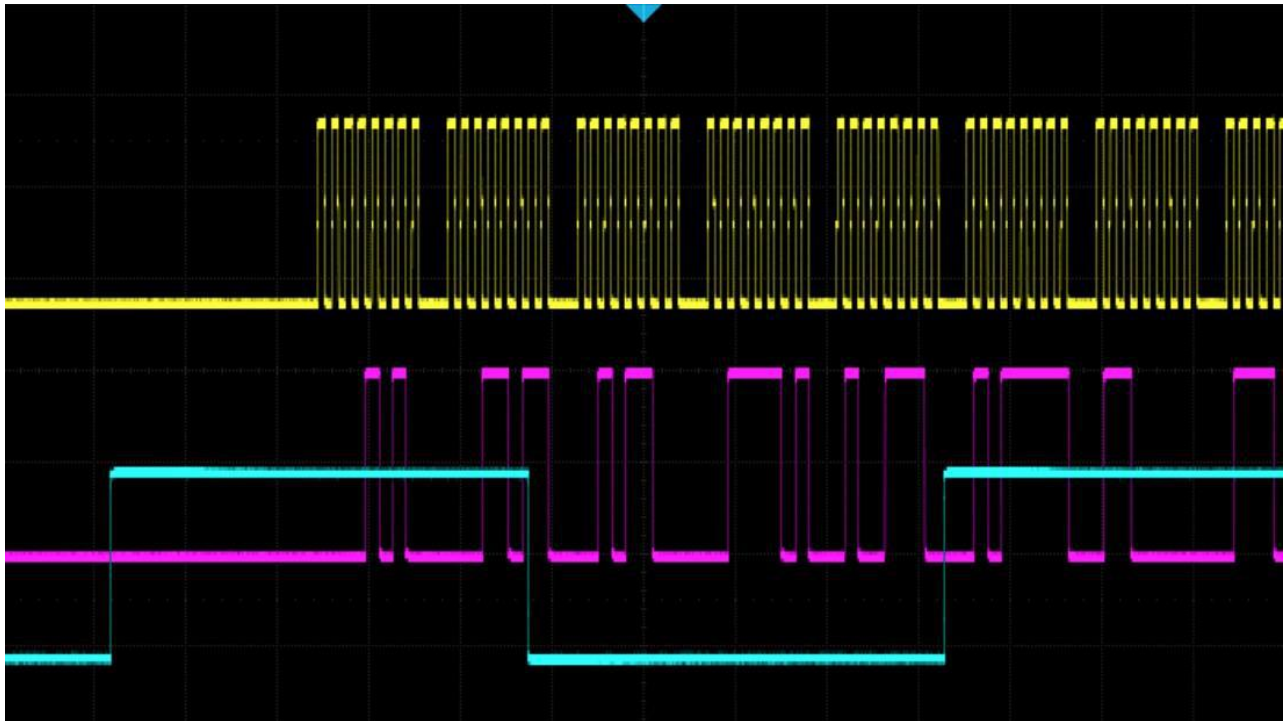

Figure 10.11 Example

When the CS type is set to Clock Timeout, the clock idle time between frames is T_3 , the clock period is T_1 , then set the timeout to a value between T_1 and T_3

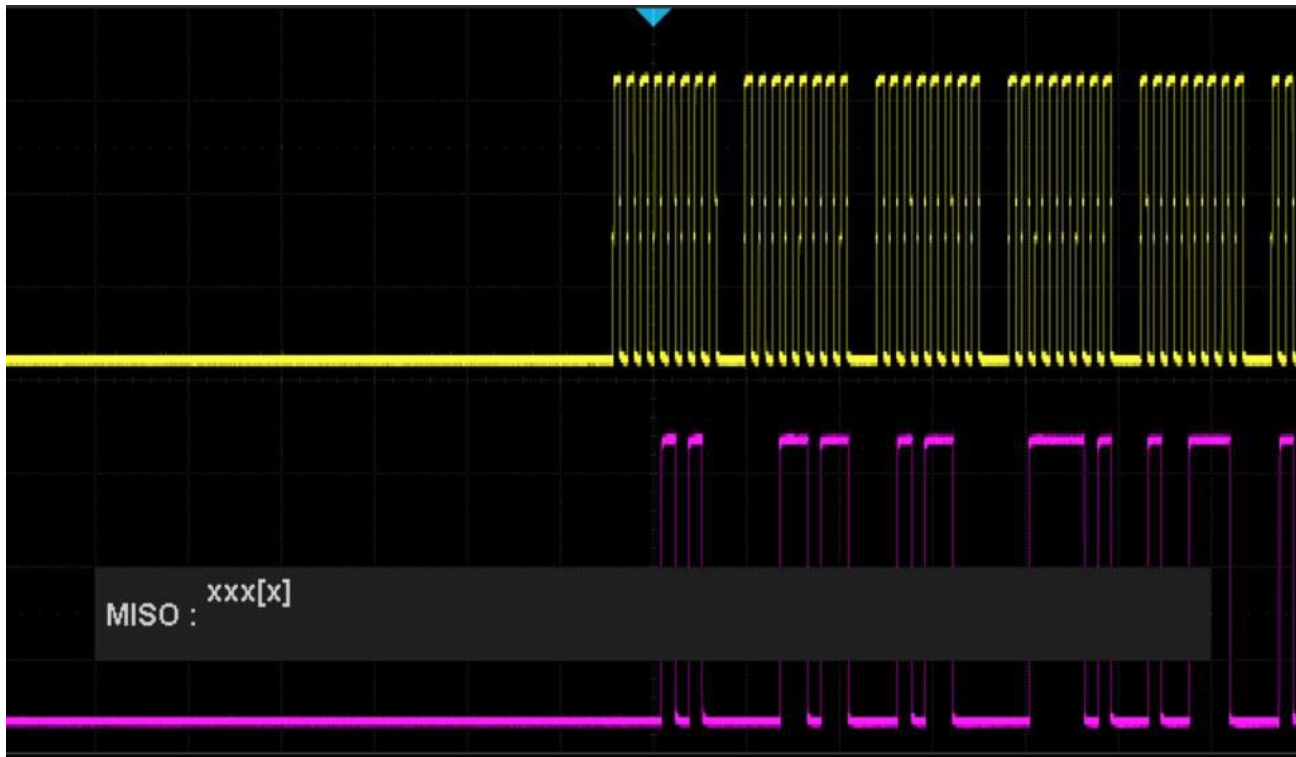

Figure 10.12 Example 2

If the data width is set to be greater than 8 bits (such as 16 bits), the clock idle time between 8-bit data packets T_2 , and then set the timeout time to a value between $T_1/2+T_2$ and T_3 .

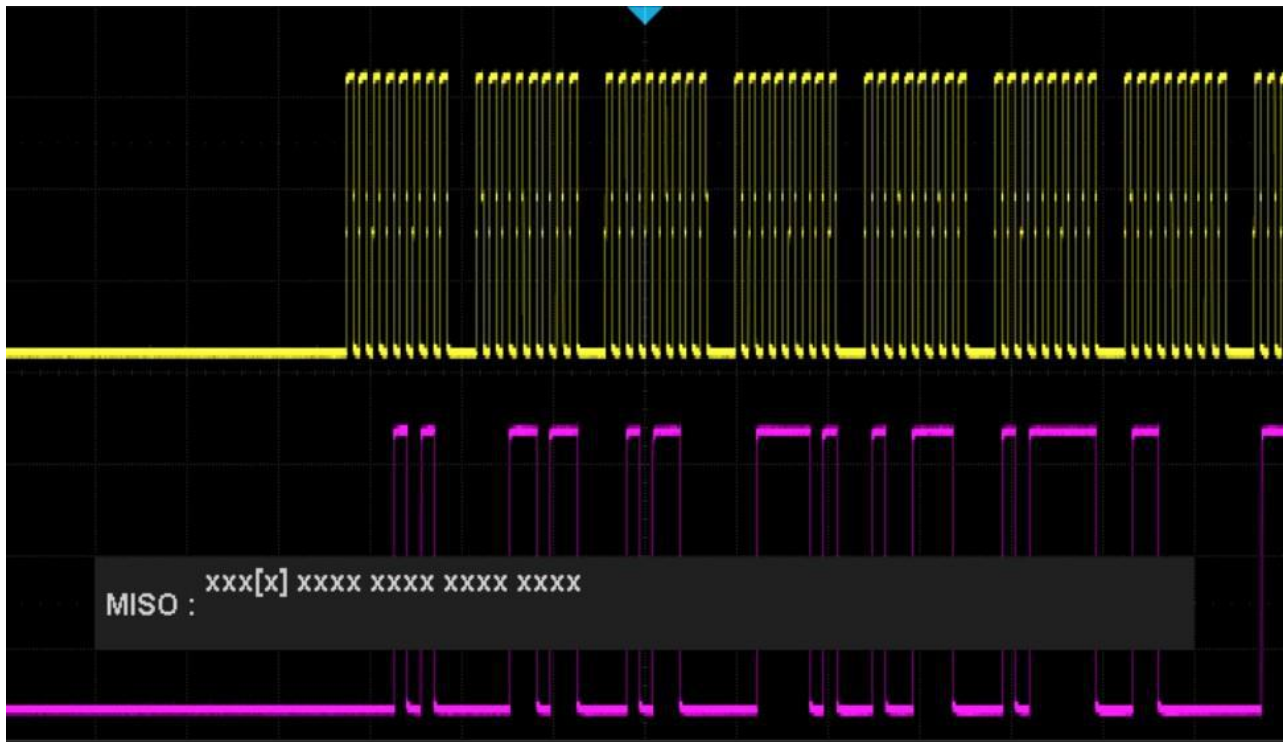

Figure 10.13 Example 3

10.2.2 SPI Trigger

This section provides a brief introduction for the operation of the SPI trigger.

1. Press the **Setup** key to enter the **TRIGGER** function menu.
2. Touch **Type** and select **Serial**.
3. Touch **Protocol** and select **SPI**.
4. Touch **Trigger Setting** softkey.
5. Touch **Trigger Type** to select the trigger condition.

Function Menu	Settings	Explanation
Trigger Type	MISO	Master-In, Slave-Out
	MOSI	Master-Out, Slave-In

Table 10.2 SPI Trigger Type

6. Touch **Data Length** and turn the Universal Knob to set the length of a data. The range of data length is 4 to 96 bits.
7. Set the value of the trigger data.
 - Set the value of a bit:
 - a. Touch **Bit Roll** to select a bit in data.
 - b. Touch **Bit Value** to set the value of the selected bit.
 - Set the value of all bits:
 - a. Touch **All Same** to set the value of all bits.

Function Menu	Settings	Explanation
Bit Value	0	High voltage level
	1	Low voltage level
	X	Don't care the voltage level

Table 10.3 SPI Bit Value

8. Touch **Bit Order** to set the bit order (MSB or LSB).

10.2.3 SPI Serial Decode

Once the setup of SPI signal and trigger is complete, the SPI signals can be decoded. Operation steps as follows:

1. Touch **Decode** → **Decode**. Select one of the options from the **Decode1** and **Decode2**.
2. Press the **Display** key and select **On** to display the result of decoding.
3. Touch **List** to enter the **LIST** function menu.
4. Touch **Display** and choose the same options as the first step.
5. Touch Lines and set the number of lines by **Universal Knob**. The range of the lines is 1 to 7.
6. Touch **Format** to change the character encoding format of the decoder's result.
7. Touch **Scroll** and turn the **Universal Knob** to view all frames.

Interpreting SPI Decode

The frames of decoding result:

- The data values are displayed in frames and are shown in white. Support 4 96-bit data display.
- *MISO* — the decoding result of "Master-In, Slave-Out" line.
- *MOSI* — the decoding result of "Master-Out, Slave-In" line.
-  Indicates there is not enough space on the display to show the complete content of a frame, and some content is hidden.



Figure 10.14 SPI Decode Bus Display

The lists of decoding result:

- *Time* — the horizontal displacement between current frame and trigger position.
- *MISO* — the decoding result of "Master-In, Slave-Out" line.
- *MOSI* — the decoding result of "Master-Out, Slave-In" line.

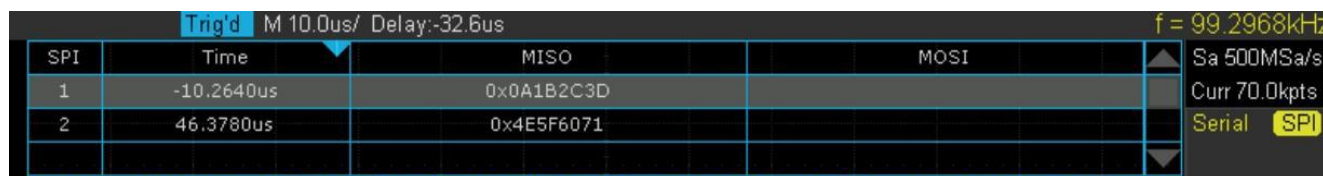



Figure 10.15 SPI Decode List Display

10.3 UART Trigger and Serial Decode

10.3.1 Setup for UART Signals

1. Press the **Decode** key to enter the **DECODE** menu.
2. Touch **Decode** and select the desired slot (Decode1 or Decode2).
3. Touch **Protocol** and then select **UART** by turning **Universal Knob**.
4. Touch **Signal** to enter the **SIGNAL** menu as below shows.
5. Set RX:
 - a. Touch **RX** to select the channel that is connected to the RX signal.
 - b. Touch first **Threshold** key to set the RX signal's threshold voltage level by **Universal Knob**. The threshold voltage level is for decoding, and it will be regard as the trigger voltage level when set the trigger type to serial.
6. Set TX:
 - a. Touch TX to select the channel that is connected to the TX signal.
 - b. Touch second Threshold key to set the TX signal's threshold voltage level by Universal Knob. The threshold voltage level is for decoding, and it will be regard as the trigger voltage level when set the trigger type to serial.
7. Touch  to return previous menu.
8. Touch **Configure** to enter **BUS CONFIG** menu.
9. Touch **Baud** to set baud rate.
 - The baud rate can be set as predefined value.
 - If the desired baud rate is not listed, press the **Baud** and select custom option, press the **Custom** and turn the **Universal Knob** to set the desired baud rate.
10. Touch **Data Length** and set byte bits (5-8) by **Universal Knob**.
11. Touch **Parity Check** to set the type of parity check (**Even, Odd, Mark, Space** or **None**).
12. Touch **Stop Bit** to set the length of stop bit (1, 1.5 or 2 bits).
13. Touch **Next Page** softkey.
14. Touch **Bit Order** to select the bit order (**LSB** or **MSB**).
15. Touch **Idle Level** to set the idle level (**LOW** or **HIGH**).

10.3.2 UART Trigger

This section includes an introduction and description for the operation of the UART trigger.

1. Touch **Setup** key to enter the **TRIGGER** function menu.
2. Touch **Type** and select **Serial**.
3. Touch **Protocol** and select **UART**.
4. Touch **Trigger Setting** to enter **UART TRIG SET** menu.
5. Touch **Source Type** to select the source of trigger (RX or TX).
6. Touch **Condition** and set up the desired trigger condition:
 - Start — the oscilloscope will be triggered at the position of start bit.
 - Stop —the oscilloscope will be triggered at the position of stop bits.
 - Data — the oscilloscope will be triggered when found a byte which is equal to (greater or less than) the specified data.
 - a. Touch **Compare Type** and choose an equality qualifier (>, < or =).
 - b. Touch **Value** to set data's value. Data's value is in range of 0x00 to 0xff.
 - ERROR — if the parity check has been set, and the bit of parity check is error, the oscilloscope will be triggered.

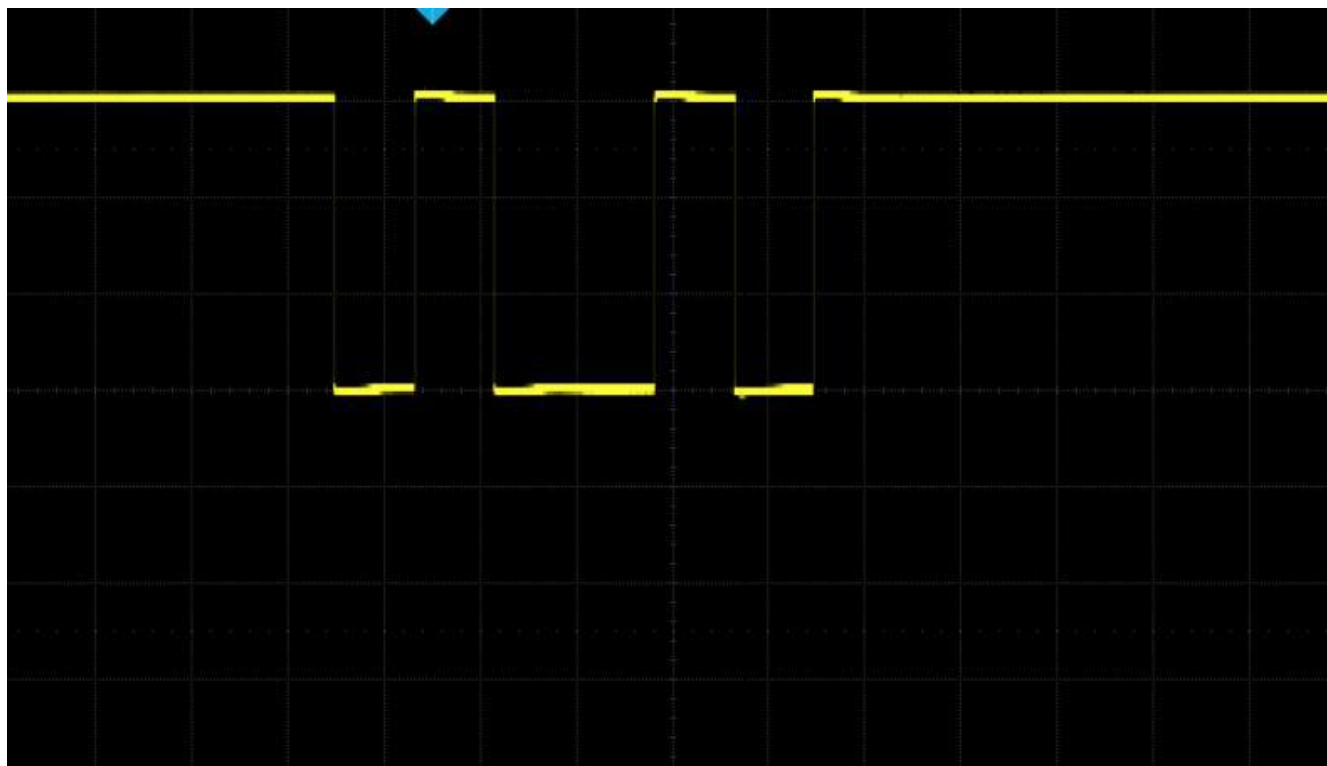

Figure 10.16 UART Trigger

10.3.3 UART Serial Decode

Upon completing the setup of UART signal and trigger, the UART signals can be decoded. Operation steps as follows:

1. Press **Decode** → **Decode**. Select one of the options from the **Decode1** and Decode2.
2. Touch **Display** and select **On** to display the result of decoding.
3. Touch **List** to enter the **LIST** function menu.
4. Touch **Display** key and choose the same options as the first step.
5. Touch **Lines** and set the number of lines by **Universal Knob**. The range of the lines is 1 to 7.
6. Touch **Format** softkey to change the character encoding format of the decoding's result.
7. Turn the **Universal Knob** to view all frames.



Figure 10.17 UART Decode

Interpreting UART Decode

The frames of decoding result:

- RX — the decoding result of the data received.
- TX — the decoding result of the data transmitted.
-  Indicates there is not enough space on the display to show the complete content of a frame, and some content is hidden.

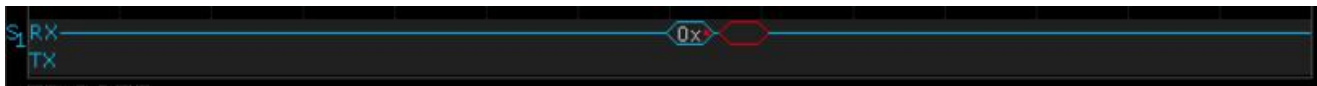

Figure 10.18 UART Decode Bus Display

The lists of decoding result:

- Time — the horizontal displacement between current frame and trigger position.
- RX — the receiving channel.
- TX — the transmitting channel.
- RX Err — Parity error or unknown error in the data received.
- TX Err — Parity error or unknown error in the data transmitted.

UART	Time	RX	RX Err	TX	TX Err
1	-90.0us	80H	Ok		
2	-90.0us	9EH	Ok	9EH	Ok
3	-3.97us	9EH	Ok		
4	-3.97us			9EH	Ok
5	79.2us	9EH	Ok		
6	79.2us			9EH	Ok

Figure 10.19 UART Decode List Display

10.4 CAN Trigger and Serial Decode

Placed in order of **Setup for CAN Signals, CAN Trigger and, CAN Serial Decode**” to trigger and decode the signals.

10.4.1 Setup for CAN Signals

1. Touch **Decode** key to enter the **DECODE** function menu.
2. Touch **Decode** and select the desired slot (Decode1 or Decode2).
3. Touch **Protocol** and then select **CAN** by turning Universal Knob.
4. Touch **Signal** to enter the **SIGNAL** menu as shown in figure ??.
 - a. Touch **Source** to select the channel that is connected to the CAN signal.
 - b. Touch **Threshold** key to set the CAN signal's threshold voltage level by **Universal Knob**. The threshold voltage level is for decoding, and it will be regard as the trigger voltage level when set the trigger type to serial.
5. Touch **Configure** to enter the **BUS CONFIG** menu.
6. Touch **Baud** to set baud rate by rotating the **Universal Knob**.
 - The baud rate can be set as predefined value (from 5kb/s to 1Mb/s) or custom value (from 5kb/s to 1Mb/s).
 - If the desired baud rate is not listed, press **Baud** and select the **custom** option, press the **Custom** and turn the **Universal Knob** to set the desired baud rate.

10.4.2 CAN Trigger

This section provides a brief introduction and description for the operation of the CAN trigger.

Trigger Conditions

- Start — the oscilloscope will be triggered at the start bit of a frame.
- Remote — the oscilloscope will be triggered by a remote frame with specified ID.
- ID — the oscilloscope will be triggered by a remote or data frame that have specified ID.
- ID+DATA — the oscilloscope will be triggered by data frame that have specified ID and data.
- Error — the oscilloscope will be triggered by an error frame.

Operation Steps

1. Touch **Setup** to enter the **TRIGGER** function menu.
2. Touch **Type** and select **Serial**.
3. Touch **Protocol** and select **CAN**.
4. Touch **Trigger Setting** to enter the **CAN TRIG SET** menu.
5. Touch **Condition** and select the trigger condition by turning the **Universal Knob**:
 - If you select the **REMOTE** and **ID** condition:
 - a. Touch **ID Bits** to set the length of ID (11bits or 29 bits).
 - b. Touch **Curr ID Byte** and turn the **Universal Knob** to select the byte that you want to set.
 - c. Touch **ID** and set the ID's value by turning the **Universal Knob**. (Tips: In order to make is convenient for the operator to set the parameters, ID b is split into several bytes. For example, if the ID's length is 11 bits, it will be split into two bytes, a byte includes 8 bits. If "1st byte" is selected, only the 8 least significant bits can be changed.)
 - If you select the **ID+DATA** condition:
 - a. Touch **ID bits** to select the ID's length (11 or 29 bits).
 - b. Touch **Curr ID Byte** and turn the **Universal Knob** to select the byte that you want to modify.
 - c. Touch **ID** and set the ID's value by turning the **Universal Knob**.
 - d. Touch **Data** and set the value of the first byte by turning the **Universal Knob**.

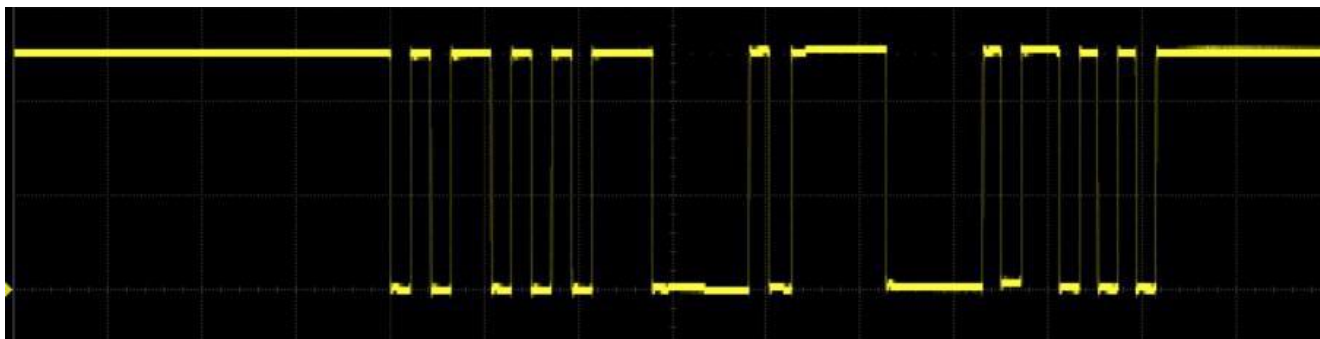

Figure 10.20 CAN Trigger

10.4.1 CAN Serial Decode

Upon completing the setup of can signal and trigger, the CAN signals can be decoded.

1. Press **Decode** → **Decode**. Select one of the options from the Decode1 and Decode2.
2. Touch **Display** and select **On** to display the result of decoding.
3. Touch **List** to enter the **LIST** function menu.
4. Touch **Display** and choose the same options as the first step.
5. Touch **Lines** and set the number of lines by **Universal Knob**. The range of the lines is 1 to 7.

6. Touch **Format** softkey to change the character encoding format of the decoder's result.
7. Touch **Scroll** and turn the **Universal Knob** to view all frames.

Interpreting CAN Decode

The frame of decoding result:

- Arbitration field is displayed in frame
- Control field is displayed in frame
- Data field is displayed in frame
- CRC field is displayed in frame
-  Indicates there is not enough space on the display to show complete content of a frame and some content is hidden.

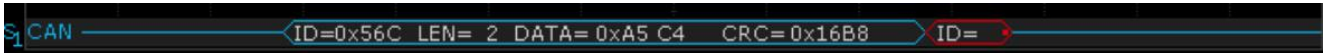

Figure 10.21 CAN Decode Bus Display

The list of decoding result:

- Time — the horizontal displacement between current frame and trigger position.
- Type — the type of frames, "D" represents data frame, "R" represents remote frame.
- ID — the id of frames, the oscilloscope can automatically detect the length of frame's id (11 bits or 27 bits).
- Length — the length of data field.
- Data — the value of data field.
- CRC — the value of CRC (Cyclic Redundancy Check) field.
- ACK — Acknowledgment bit.

CAN	Time	Type	ID	Length	Data	CRC	ACK	
1	-18.9655ms	D	0x56C	2	0xA5 C4	0x16B8	yes	▲
2	-18.2711ms						no	■
3	-4.55200us	D	0x56C	2	0xA5 C4	0x16B8	yes	▼

Figure 10.22 CAN Decode List Display

10.5 LIN Trigger and Serial Decode

10.5.1 Setup for LIN Signals

There are two steps of setting the LIN signal, connecting the signal to oscilloscope, specifying the parameters of each input signal.

1. Press the **Decode** key to enter the **DECODE** function menu.
2. Touch **Decode** and select the desired slot (Decode1 or Decode2).
3. Touch **Protocol** and then select **LIN** by turning Universal Knob.
4. Touch **Signal** to enter the **SIGNAL** menu as shown in figure ??.
5. Touch **Source** to select the channel that is connected to the LIN signal.
6. Touch **Threshold** and set the LIN signal's threshold voltage level by **Universal Knob**. The threshold voltage level is for decoding, and it will be regard as the trigger voltage level when set the trigger type to serial.
7. Touch  to return previous menu.
8. Touch **Configure** to enter the **BUS CONFIG** menu.
9. Touch **Baud** to set baud rate.
 - The baud rate can be set as predefined value.
 - If the desired baud rate is not listed, select **custom** option, press the Custom and turn the **Universal Knob** to set the desired baud rate.

10.5.2 LIN Trigger

This section provides a brief introduction and description for the operation of the LIN trigger.

Trigger Condition

- **Break** — the oscilloscope will be triggered at the position of break field's break delimiter.
- **ID** (Frame ID) — the oscilloscope will be triggered at the position of identifier field's stop bit, if the value of a frame's ID is equal to specified value. (Note: If the data's value is 0xXX, any data value will be matched)
- **ID + Data** (Frame ID and Data) — the oscilloscope triggers when a frame with an ID and data equal to the selected values is detected. Use the **Universal Knob** to select the value for the ID, Data1 and Data2.
 - a. The ID's value is the same as set value.
 - b. If you have set either Data1's or Data2's value, and the signal has a data is the same as that value. If you have set both Data1's and Data2's value, the signal should have two consecutive data, the first data's value is Data1, second data value is Data2.

Note:

If the data's value is 0xXX, any data value will be matched

- **Data Error** —the oscilloscope will be triggered when errors (such as ID check error, checksum error, sync byte field error) are detected.

Operation Steps

- Touch **Setup** key to enter the **TRIGGER** function menu.
- Touch **Type** and select **Serial**.
- Touch **Protocol** and select **I2C**.
- Touch **Trigger Setting** to enter **LIN TRIG SET** menu.
- Touch **Condition** and select the trigger condition by **Universal Knob**:
 - If you select **ID** condition:
 - Touch **ID** and set its value by turning the **Universal Knob**.
 - If you select **ID+DATA** condition:
 - Touch **ID** and set its value by turning the **Universal Knob**.
 - Touch **DATA1** and set its value by turning the Universal Knob.
 - Touch **DATA2** and set its value by turning the Universal Knob.

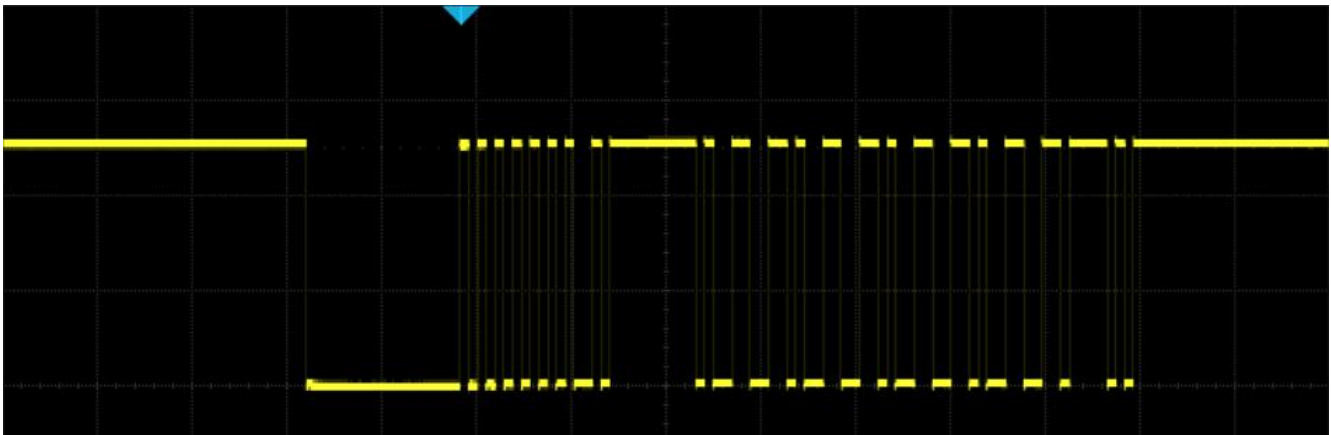



Figure 10.23 LIN Trigger

10.5.1 Interpreting LIN Decode

The frame of decoding result:

- Protected Identifier Field is displayed in frame
- Data Length is displayed in frame
- Data Field is displayed in frame.
- Checksum Field is displayed in frame.
-  Indicates there is not enough space on the display to show complete content of a frame and some content is hidden.

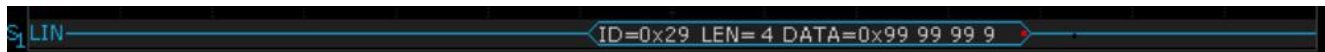

Figure 10.24 LIN Decode Bus Display

The list of decoding result:

- Time — the horizontal displacement between current frame and trigger position.
- ID — the value of frame's Protected Identifier Field.
- Data Length — the length of Data Field.
- ID Parity — the two check bits of Protected Identifier Field.
- Data — the value of Data Field.
- Checksum — the value of Checksum Field.

LIN	Time	ID	Data Length	ID Parity	Data	Checksum
1	-1.79606ms	0x29	4	0x03	0x99 99 99 99	0xAF

Figure 10.25 LIN Decode List Display

10.6 FlexRay Trigger and Serial Decode

This section covers triggering and decoding FlexRay signals. Please read the following for more details: [FlexRay Signal Configuration](#), [FlexRay Trigger](#) and [FlexRay Serial Decode](#).

Before configuring the signal settings, connect the FlexRay signal to the oscilloscope.

10.6.1 FlexRay Signal Configuration

To select the decoding **Bus Protocol**:

1. Press the Decode key or use the touchscreen controls to enter the **Decode Menu**.
2. Use the touchscreen to enable **Bus Operation**.
3. Use the touchscreen to select **Bus Protocol**.
4. The window shown in figure 10.1 will appear with the addition of the **Manchester** protocol.
5. Select the **FlexRay** bus protocol.

Protocol Signals

To set the source and threshold of the **FlexRay** signal use the touchscreen to select **Protocol Signal**:

1. The **FLX SIGNAL** menu will be displayed. (Figure 10.27)
2. Use the touchscreen to select **Source** and select the source the signal is connected to.
3. Use the touchscreen to select **Threshold** and input the desired threshold
 - The threshold voltage level is for decoding, and it will be regarded as the trigger voltage level when the trigger type is set to serial.
 - The threshold level line only appears when adjusting the threshold level.
4. Touch  option to return previous menu.

Protocol Config

To set the baud rate use the touchscreen to select **Protocol Config**:

1. The **FLX CONFIG** menu will be displayed. (Figure 10.28)
2. Use the touchscreen to select **Baud** and set the baud rate.
 - The baud rate can be set to 2.5 Mb/s, 5.0 Mb/s, 10.0 Mb/s or Custom.
3. Touch  option to return previous menu.

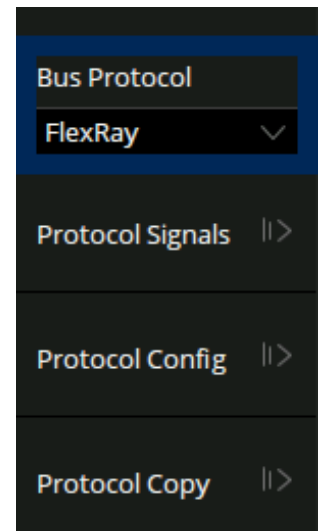

Figure 10.26
Decode FlexRay Protocol

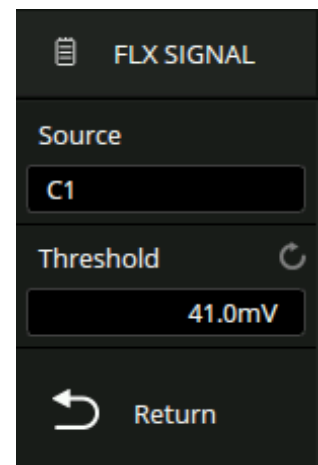

Figure 10.27
FlexRay Signal Menu

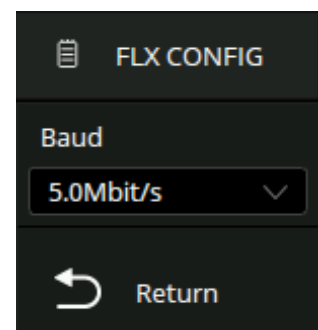



Figure 10.28 FlexRay CONFIG

Protocol Copy

The signal settings of decoding and triggering are independent. To synchronize the settings between decode and trigger select **Protocol Copy**.

1. The **DECODE COPY** menu will be displayed. (Figure 10.29)
2. Use the touchscreen to select **Copy To Trigger** or **Copy From Trigger**.
3. **Copy To Trigger** copies the decode settings to trigger.
4. **Copy From Trigger** copies the trigger settings to decode.
5. Touch  option to return previous menu.

Note:

The synchronization is not automatic. If the settings at one place change, a copy operation is necessary to re-synchronize.

10.6.2 FlexRay Trigger

To select **FlexRay Trigger**:

1. Touch the **Trigger** dialog box to display the **Trigger** menu.(Figure 10.30)
2. Use the touch screen to select **Protocol**.
 - the dropdown menu shown in figure ?? will appear.
3. Select **FlexRay**.
4. Use the touchscreen to select **Trigger Setting**.
 - Select the desired condition.
 - **TSS**
 - **Frame**
 - **Symbol**
 - **Errors**

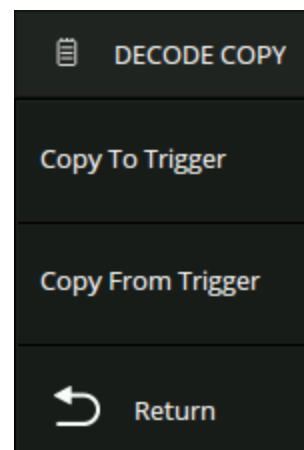

Figure 10.29
Decode Copy

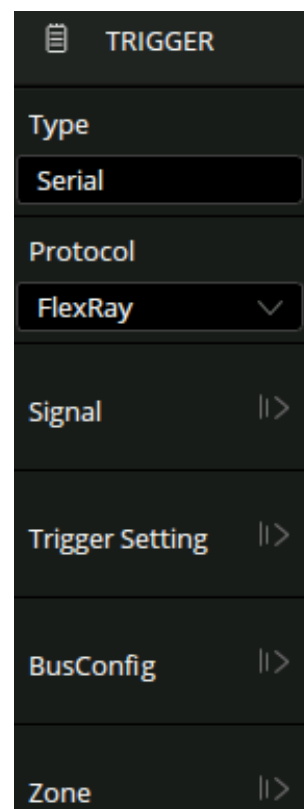



Figure 10.30
FlexRay Trigger

- **TSS:** The oscilloscope triggers on the transmission start sequence.
- **Frame:** The oscilloscope triggers on the frame.
 - Set Frame header indicators: Payload preamble indicator, null frame indicator, sync frame indicator, startup frame indicator.
 - Touch ID to set the frame ID by the universal knob or virtual keypad. The range of ID is 0x000 to 0x7ff.
 - Touch Compare Type to select "=", ">" or "<". When setting the Compare Type as "=", the repetition factor is also required.
 - Touch Cycle to set the cycle count by the universal knob or virtual keypad. The range of data value is 0 to 63.
- **Symbol:** The oscilloscope triggers on CAS/MTS (Conflict Avoidance Symbol/ Media access Test Symbol) or WUS (Wake-up Symbol)
- **Errors:** The oscilloscope will trigger when a data error happens, including errors on FSS, BSS, FES, Header CRC, and Frame CRC.

10.6.3 FlexRay Serial Decode

Once the setup for the FlexRay signal and trigger has been completed, the decoding operation must be setup.

1. Touch Decode key to display the **Decode** menu.
2. Use the touchscreen to enable the **Bus Operation**.
3. Touch **Bus** to select either **Bus1** or **Bus2**.
4. Touch **Display** to select the character encoding format of the decoding's result.
 - The bus's vertical position can be adjusted using the **Universal Knob** after selecting **Bus Position**.
5. Touch  to return to the **Decode** menu.
6. Touch **Display** option and choose the bus option selected in step 3.
7. Touch **Lines** options and set the number of lines by **Universal Knob** or the virtual keypad.
 - The range of the lines is 1 to 7.
8. Touch **Scroll** option and turn the Universal Knob to navigate the available lines.

Interpreting the FlexRay Decode

On the bus:

- The signatures (CAS/MTS, WUP) are displayed in yellow-green.
- TSS transmission start sequence, displayed in yellow-green. The null frame indicator, the Sync frame indicator, and the Startup frame indicator are displayed in the frame and displayed in pink.
- The ID is displayed in the frame and is displayed in green.
- PL (Valid Data Length) is displayed in frames, in words, in light yellow.
- HCRC (Head Check Code) is displayed in the frame and displayed in blue.
- CYC (cycle) is displayed in the frame and displayed in light yellow.
- D (data) is displayed in the frame and displayed in white.
- FCRC (Data Check Code) is displayed in the frame and displayed in blue.

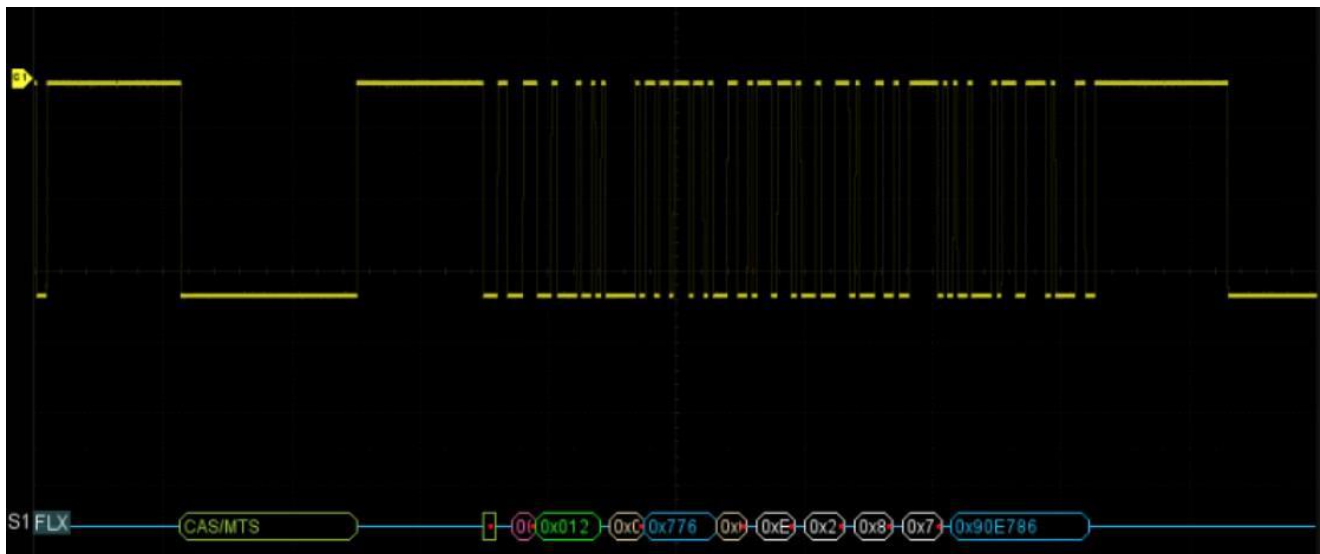

Figure 10.31 FlexRay Signal Decode

In the list view:

- **Time:** The horizontal offset of the current data frame head relative to the trigger position.
- **FID:** Frame ID, symbol occupies a single line of the list.
- **PL:** Valid Data Length
- **HCRC:** Head Check Code
- **CYC:** Cycle count
- **Data:** Data values
- **FCRC:** Data Check Code

FLX	Time	FID	PL	HCRC	CYC	Data	FCRC
1	-83.0406us	0x012	0x02	0x776	0x0C	0xEE 0x23 0x8C 0x7E	0x90E786
2	-25.0160us	CAS/MTS					
3	-1.40820us	0x012	0x02	0x776	0x0C	0xEE 0x23 0x8C 0x7E	0x90E786
4	56.6174us	CAS/MTS					
5	80.2240us	0x012	0x02	0x776			

Figure 10.32 FlexRay Signal Decode List View

10.7 CAN FD Trigger and Serial Decode

This section covers triggering and decoding CAN FD signals. Please read the following for more details: **CAN FD Signal Configuration**, **CAN FD Trigger** and **CAN FD Serial Decode**.

Before configuring the signal's settings connect the CAN FD signal to the oscilloscope.

10.7.1 CAN FD Signal Configuration

To select the decoding **Bus Protocol**:

1. Press the Decode key or use the touchscreen controls to enter the **Decode Menu**.
2. Use the touchscreen to enable **Bus Operation**.
3. Use the touchscreen to select **Bus Protocol**.
4. The window shown in figure 10.1 will appear with the addition of the **Manchester** protocol.
5. Select the **CAN FD** bus protocol.

Protocol Signals

To set the source and threshold of the **CAN FD** signal use the touchscreen to select **Protocol Signal**:

1. The **CAN FD** menu will be displayed. (Figure 10.34)
2. Use the touchscreen to select **Source** and select the source the signal is connected to.
3. Use the touchscreen to select **Threshold** and input the desired threshold
 - The threshold voltage level is for decoding, and it will be regarded as the trigger voltage level when the trigger type is set to serial.
 - The threshold level line only appears when adjusting the threshold level.
4. Touch  option to return previous menu.

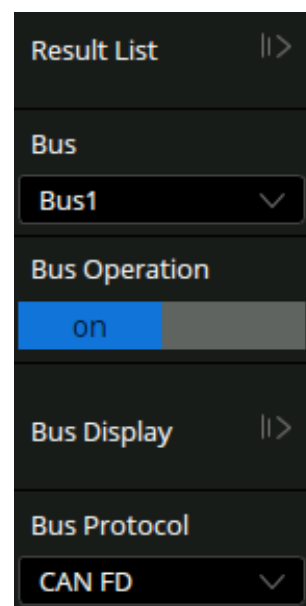

Figure 10.33 Decode CAN FD Protocol

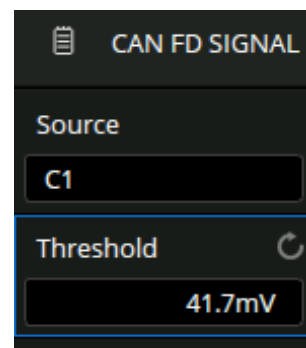



Figure 10.34 CAN FD Signal Menu

Protocol Config

To set the baud rate use the touchscreen to select **Protocol Config**:

1. The **CAN FD** menu will be displayed. (Figure 10.35)
2. Use the touchscreen to select **Baud** and set the baud rate.
 - The baud rate can be set to: 10 kb/s, 25 kb/s, 50 kb/s, 100 kb/s, 250 kb/s, 1 Mb/s or Custom. The data baud rate can be set to: 500 kb/s, 1 Mb/s, 2 Mb/s, 5 Mb/s, 8 Mb/s, 10 Mb/s or Custom.
3. Touch  option to return previous menu.

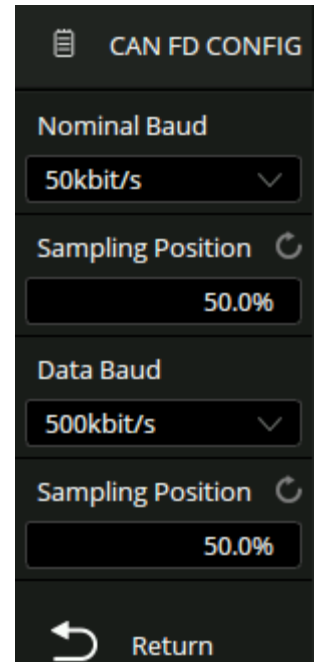



Figure 10.35 CAN FD Config

Protocol Copy

The signal settings of decoding and triggering are independent. To synchronize the settings between decode and trigger select Protocol Copy.

1. The **DECODE COPY** menu will be displayed. (Figure ??)
2. Use the touchscreen to select **Copy To Trigger** or **Copy From Trigger**.
3. **Copy To Trigger** copies the decode settings to trigger.
4. **Copy From Trigger** copies the trigger settings to decode.
5. Touch  option to return previous menu.

Note:

The synchronization is not automatic. If the settings at one place change, a copy operation is necessary to re-synchronize.

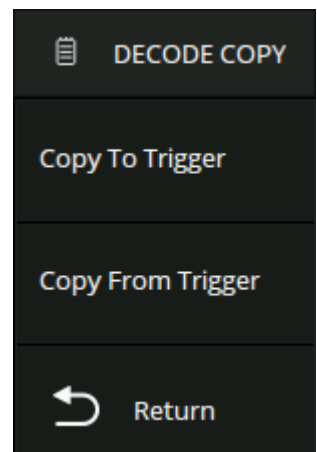

Figure 10.36 Decode Copy

10.7.2 CAN FD Trigger

To select **CAN FD Trigger**:

1. Touch the **Trigger** dialog box to display the **Trigger** menu.
2. Use the touch screen to select **Protocol**.
 - the dropdown menu shown in figure ?? will appear.
3. Select **CAN FD**.
4. Use the touchscreen to select **Trigger Setting**.
 - The **CAN FD SETTING** menu will appear (Figure 10.37)
5. Set the desired parameters.

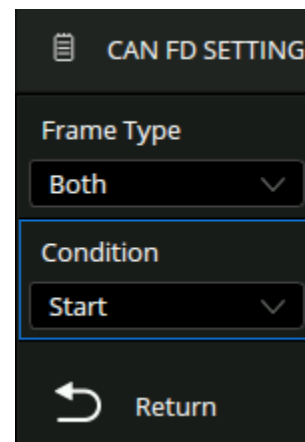

Figure 10.37
CAN FD Settings

CAN FD Trigger Conditions

- **Start**: The oscilloscope triggers at the beginning of the frame.
- **Remote**: The oscilloscope triggers on a remote frame with a specified ID. ID, ID Bits (11-bit or 29-bit) and Curr ID Byte (1st, 2nd, 3rd, or 4th byte) can be set. Curr ID Byte is used to specify the byte to be adjusted when using the universal knob.
- **ID**: The oscilloscope triggers on the data frame that matches the specified ID. ID, ID Bits (11-bit or 29-bit), and Curr ID Byte (1st, 2nd, 3rd, or 4th byte) can be set.
- **ID + Data**: The oscilloscope triggers on the data frame that matches the specified ID and data. ID, ID Bits (11-bit or 29-bit), Curr ID Byte (1st, 2nd, 3rd, or 4th byte), Data1 and Data2 can be set.
- **Error**: The oscilloscope triggers on the:
 - Error Frame
 - Stuff Bit Error
 - CRC Mismatch Error: The oscilloscope triggers when the calculated CRC does not match the transmitted CRC.
 - Stuff Bit Cnt Err: Effective only when ISO is turned on, the oscilloscope triggers when the stuff bit count is incorrect.
 - Stuff Bit Cnt Par. Err: Effective only when ISO is turned on, the oscilloscope triggers when the polarity of the stuff bit count is incorrect.

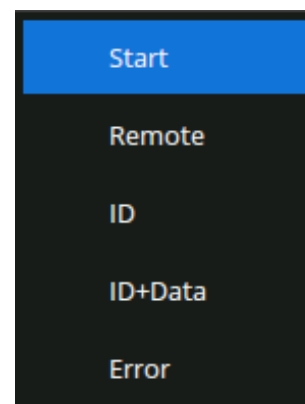



Figure 10.38
CAN FD Conditions

10.7.3 CAN FD Serial Decode

Once the setup for the FlexRay signal and trigger has been completed, the decoding operation must be setup.

1. Touch Decode key to display the **Decode** menu.
2. Use the touchscreen to enable the **Bus Operation**.

3. Touch **Bus** to select either **Bus1** or **Bus2**.
4. Touch **Display** to select the character encoding format of the decoding's result.
 - The bus's vertical position can be adjusted using the **Universal Knob** after selecting **Bus Position**.
5. Touch  to return to the **Decode** menu.
6. Touch **Display** option and choose the bus option selected in step 3.
7. Touch **Lines** options and set the number of lines by **Universal Knob** or the virtual keypad.
 - The range of the lines is 1 to 7.
8. Touch **Scroll** option and turn the Universal Knob to navigate the available lines.

Interpreting the CAN FD Decode

On the bus:

- ID is displayed in green.
- BRS (Bit Rate Switch) is displayed in light yellow.
- ESI (Error State Indicator) is displayed in blue.
- L (Data Length) is displayed in light yellow.
- D (Data) is displayed in white.
- CRC is displayed in blue.
- Ack is displayed in pink.
- The red point at the end of a segment indicates there is not enough space on the display to show the complete content of a frame and some content is hidden.

In the list view:

- **Time:** The horizontal offset of the current data frame head relative to the trigger position.
- **Type:** Type of the frame. Standard CAN frame is represented by "Std", CAN FD frame is represented by "FD", the extended frame is represented by "Ext" and the remote frame is represented by "RTR".
- **ID:** Frame ID.
- **Length:** Data length.
- **Data:** Data bytes.
- **CRC:** Cycle redundancy check.
- **Ack:** Acknowledge bit.

CAN FD	Time	Type	ID	Length	Data	CRC	ACK
1	-190.506us	FD Std	0x66	0x08	0x0A 1B 2C 3D 4E 5F 60 71	0x9ADA	yes
2	-95.5054us	FD Std	0x66	0x08	0x0A 1B 2C 3D 4E 5F 60 71	0x9ADA	yes
3	-505.600ns	FD Std	0x66	0x08	0x0A 1B 2C 3D 4E 5F 60 71	0x9ADA	yes
4	94.4942us	FD Std	0x66	0x08	0x0A 1B 2C 3D 4E 5F 60 71	0x9ADA	yes
5	189.496us	FD Std	0x66	0x08	0x0A 1B 2C 3D 4E 5F 60 71	0x9ADA	yes

Figure 10.39 CAN FD Decode List

10.8 I2S Trigger and Serial Decode

This section covers triggering and decoding I2S signals. Please read the following for more details: **I2S Signal Configuration**, **I2S Trigger** and **I2S Serial Decode**

Before configuring the signals settings connect the I2S signal to the oscilloscope.

10.8.1 I2S Signal Configuration

To select the decoding **Bus Protocol**:

1. Press the Decode key or use the touchscreen controls to enter the **Decode Menu**.
2. Use the touchscreen to enable **Bus Operation**.
3. Use the touchscreen to select **Bus Protocol**.
4. The window shown in figure 10.1 will appear with the addition of the **Manchester** protocol.
5. Select the **I2S** bus protocol.

Protocol Signals

To set the source and threshold of the **I2S** signal use the touchscreen to select **Protocol Signal**:

1. The **I2S SIGNAL** menu will be displayed. (Figure 10.40)

BCLK

2. Use the touchscreen to select **BCLK**, the **Source Setting** window will appear.
 - Select the channel that will provide the bit clock signal.
 - Use the touchscreen to select **Threshold** and input the desired threshold.
 - The threshold voltage level is for decoding, and it will be regarded as the trigger voltage level when the trigger type is set to serial.
 - The threshold level line only appears when adjusting the threshold level.
 - Use the touch screen to select either **Rising** or **Falling** edge.
 - **Rising**: Data latched on the rising edge of the clock.
 - **Falling**: Data latched on the falling edge of the clock.



Figure 10.40
I2S Signal Menu

WS

- Use the touchscreen to select **WS** and select the source the signal is connected to.
- Use the touchscreen to select **Threshold** and input the desired threshold
 - The threshold voltage level is for decoding, and it will be regarded as the trigger voltage level when the trigger type is set to serial.
 - The threshold level line only appears when adjusting the threshold level.
- Use the touch screen to select either **Low** or **High** Left CH.
 - **Low**: Select left channel when WS is low and right channel when WS is high.
 - **High**: Select the right channel when WS is low and left channel when WS is high.
- Use the touchscreen to select **Data** the **Source Setting** window will appear.
 - Select the channel that will provide the data signal.
 - Use the touchscreen to select **Threshold** and input the desired threshold.
 - Touch  option to return previous menu.

Protocol Config

To configure the protocol touch **Protocol Config**:

1. The **I2S CONFIG** menu will be displayed. (Figure 10.41)
2. Use the touchscreen to select **Audio Variant**. The following variants are available:
 - Audio-I2S
 - Audio-LJ
 - Audio-RJ
3. Use the touchscreen to select **Start Bit** and input the starting bit.
4. Use the touchscreen to select **Data Bits** and enter the word size. (4 to 32 bits)
 - The word size of the device under test must be matched.
5. Use the touchscreen to select **LSB** or **MSB** to set the bit order.
6. Use the touchscreen to select **Annotate**. The following option are available:
 - All
 - Left
 - Right
7. Touch  option to return previous menu.

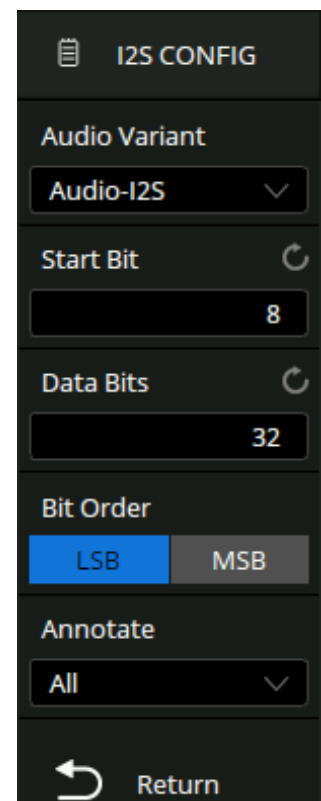



Figure 10.41 I2S CONFIG

Protocol Copy

The signal settings of decoding and triggering are independent. To synchronize the settings between decode and trigger select Protocol Copy.

1. The **DECODE COPY** menu will be displayed. (Figure 10.29)
2. Use the touchscreen to select **Copy To Trigger** or **Copy From Trigger**.
3. **Copy To Trigger** copies the decode settings to trigger.
4. **Copy From Trigger** copies the trigger settings to decode.
5. Touch  option to return previous menu.

Note:

The synchronization is not automatic. If the settings at one place change, a copy operation is necessary to re-synchronize.

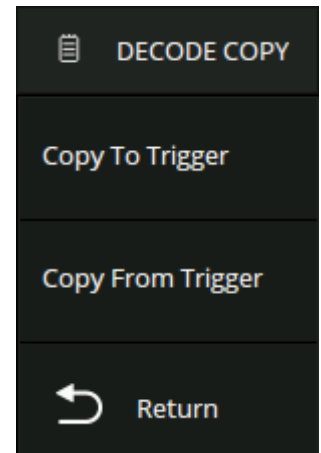

Figure 10.42 Decode Copy

10.8.2 I2S Trigger

To select **I2S Trigger**:

1. Touch the **Trigger** dialog box to display the **Trigger** menu.
2. Use the touch screen to select **Protocol**.
 - the dropdown menu shown in figure ?? will appear.
3. Select **I2S**.
4. Use the touchscreen to select **Trigger Setting**.
 - The **I2S SETTING** menu will appear (Figure 10.43)
5. Set the desired parameters.

I2S Trigger Conditions

- **Data:** Trigger on data.
 - Touch Compare Type to select "=", ">" or "<".
 - Touch Value to set the data value by the universal knob or virtual keypad. The range of data value is related to the number of Data Bits.
- **Mute:** Trigger on the mute signal. Mute signal: Volume is less than the set value and duration reach the set value.
 - Touch MNF to set the mute threshold by the universal knob or virtual keypad. The range of value is related to the number of Data Bits.
 - Touch Duration to set the value by the universal knob or virtual keypad. The range is 1-64 frames.
- **Clip:** Trigger on a clipped signal. Clip signal: Volume is greater than the set value and duration reaches the set value.
 - Touch Clip Level to set the clip threshold by the universal knob or virtual keypad. The range of value is related to the number of Data Bits.
 - Touch Duration to set the value by the universal knob or virtual keypad. The range is 1-64 frames.
- **Glitch:** Trigger on glitches within the audio signal.
 - Touch Threshold to set the threshold by the universal knob or virtual keypad. The range of value is related to the number of Data Bits.
- **Rising Edge:** Trigger on signals greater than the Threshold setting value.
 - Touch Threshold to set the threshold by the universal knob or virtual keypad. The range of values is related to the number of Data Bits.
- **Falling Edge:** Trigger on signals less than the Threshold setting value.
 - Touch Threshold to set the threshold by the universal knob or virtual keypad. The range of value is related to the number of Data Bits

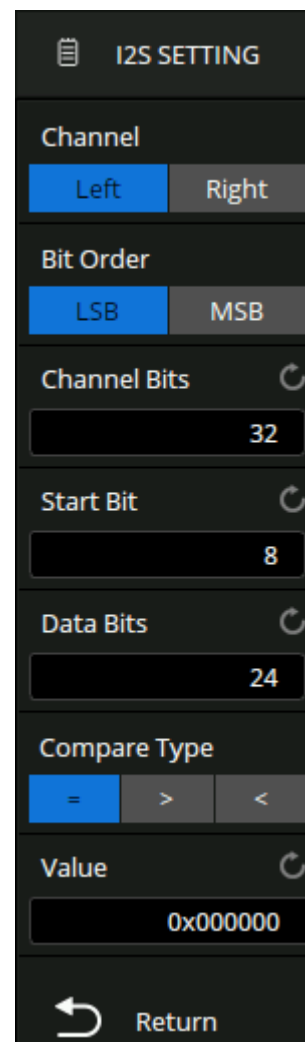



Figure 10.43
I2S Trigger Settings

10.8.3 I2S Serial Decode

Once the setup for the FlexRay signal and trigger has been completed, the decoding operation must be setup.

1. Touch Decode key to display the **Decode** menu.
 2. Use the touchscreen to enable the **Bus Operation**.
 3. Touch **Bus** to select either **Bus1** or **Bus2**.
 4. Touch **Display** to select the character encoding format of the decoding's result.
- The bus's vertical position can be adjusted using the **Universal Knob** after selecting **Bus Position**.
5. Touch  to return to the **Decode** menu.
 6. Touch **Display** option and choose the bus option selected in step 3.
 7. Touch **Lines** options and set the number of lines by **Universal Knob** or the virtual keypad.
- The range of the lines is 1 to 7.
8. Touch **Scroll** option and turn the Universal Knob to navigate the available lines.

Interpreting the I2S Decode

In the list view:

- **Time:** The horizontal offset of the current data frame head relative to the trigger position.
- **Type:** Channel type, the left channel is represented by "Left CH" and the right channel is represented by "Right CH".
- **Data:** Data bytes.
- **Error:** Error

I2S	Time	Type	Data	Error
0	-600.034us	Right CH	0x01	
1	-100.006us	Left CH	0x03	
2	399.977us	Right CH	0x01	
3	899.996us	Left CH	0x01	

Figure 10.44 I2S Decode List

10.9 MIL-STD-1553B Trigger and Serial Decode

This section covers triggering and decoding MIL-STD-1553B signals. Please read the following for more details: **MIL-STD-1553B Signal Configuration**, and **MIL-STD-1553B Serial Decode**.

Before configuring the signals settings connect the MIL-STD-1553B signal to the oscilloscope.

10.9.1 MIL-STD-1553B Signal Configuration

To select the decoding **Bus Protocol**:

1. Press the Decode key or use the touchscreen controls to enter the **Decode Menu**.
2. Use the touchscreen to enable **Bus Operation**.
3. Use the touchscreen to select **Bus Protocol**.
4. The window shown in figure 10.1 will appear with the addition of the **Manchester** protocol.
5. Select the **MIL-STD-1553B** bus protocol.

Protocol Signals

To set the source and threshold of the **MIL-STD-1553B** signal use the touchscreen to select

Protocol Signal:

1. The **MIL-STD-1553B** menu will be displayed. (Figure 10.46)
2. Use the touchscreen to select **Source** and select the source the signal is connected to.
3. Use the touchscreen to select **Upper Threshold** and input the desired threshold
 - The threshold voltage level is for decoding, and it will be regarded as the trigger voltage level when the trigger type is set to serial.
 - The threshold level line only appears when adjusting the threshold level.
4. Use the touchscreen to select **Lower Threshold** and input the desired threshold
 - The threshold voltage level is for decoding, and it will be regarded as the trigger voltage level when the trigger type is set to serial.
 - The threshold level line only appears when adjusting the threshold level.
5. Touch  option to return previous menu.

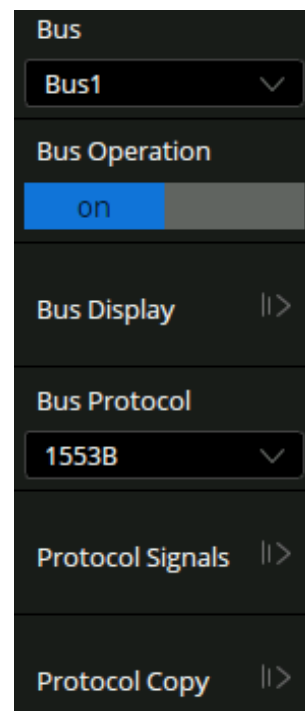

Figure 10.45
MIL-STD-1553B Decode

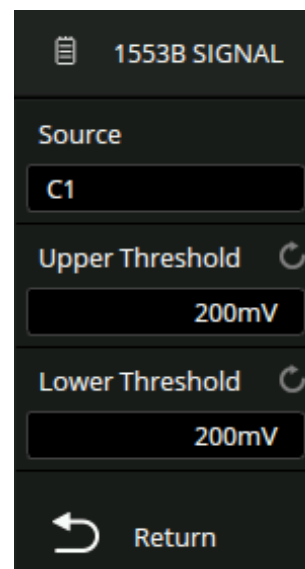



Figure 10.46
MIL-STD-1553B Signal Menu

Protocol Copy

The signal settings of decoding and triggering are independent. To synchronize the settings between decode and trigger select Protocol Copy.

1. The **1553B DECODE COPY** menu will be displayed. (Figure ??)
2. Use the touchscreen to select **Copy To Trigger** or **Copy From Trigger**.
3. **Copy To Trigger** copies the decode settings to trigger.
4. **Copy From Trigger** copies the trigger settings to decode.
5. Touch  option to return previous menu.

Note:

The synchronization is not automatic. If the settings at one place change, a copy operation is necessary to re-synchronize.

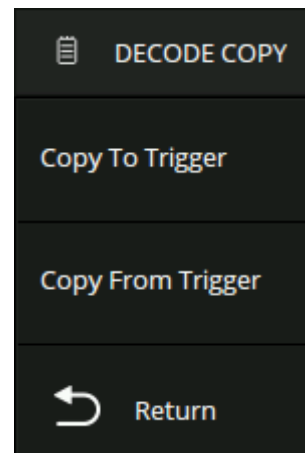



Figure 10.47 Decode Copy

10.9.2 MIL-STD-1553B Serial Decode

Once the setup for the FlexRay signal and trigger has been completed, the decoding operation must be setup.

1. Touch Decode key to display the **Decode** menu.
2. Use the touchscreen to enable the **Bus Operation**.
3. Touch **Bus** to select either **Bus1** or **Bus2**.
4. Touch **Display** to select the character encoding format of the decoding's result.
 - The bus's vertical position can be adjusted using the **Universal Knob** after selecting **Bus Position**.
5. Touch  to return to the **Decode** menu.
6. Touch **Display** option and choose the bus option selected in step 3.
7. Touch **Lines** options and set the number of lines by **Universal Knob** or the virtual keypad.
 - The range of the lines is 1 to 7.
8. Touch **Scroll** option and turn the Universal Knob to navigate the available lines.

Interpreting the MIL-STD-1553B Decode

On the bus:

- C/S the Command/Status word is displayed in green.
- RTA the RT address is displayed in the frame and displayed in light yellow.
- C/S Data is displayed in the frame and is displayed in white.
- The data word is displayed in yellow and the data is displayed in the frame and displayed in white.
- Check Code is displayed in the frame and displayed in blue

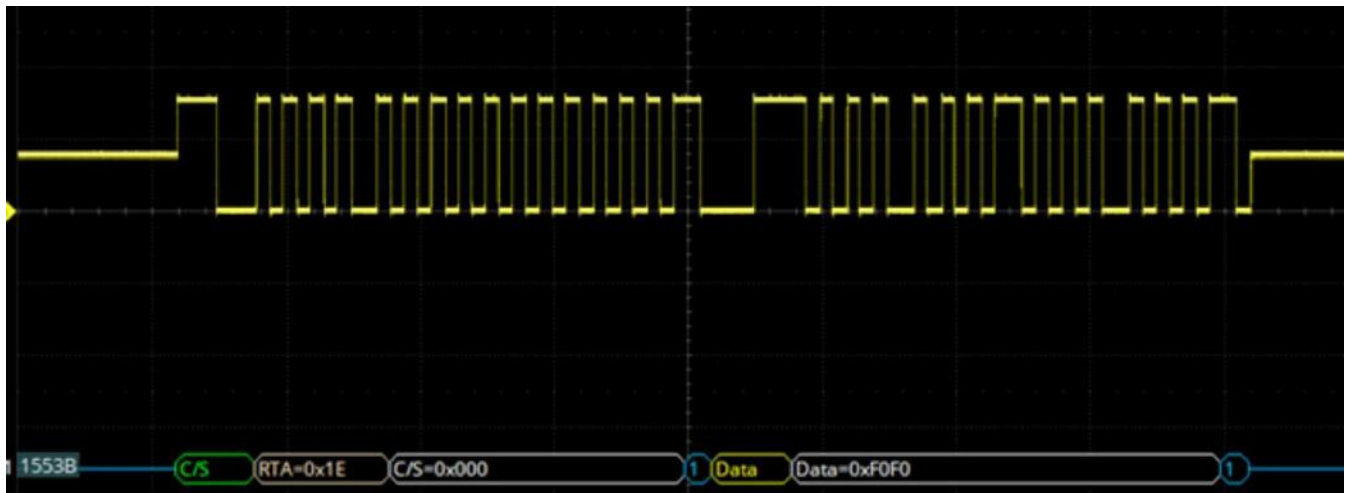

Figure 10.48 1553B Bus

In the decoding list view:

- **Time:** The horizontal offset of the current data frame head relative to the trigger position.
- **RTA:** The RT address
- **Type:** Type of the word
- **Data:** Data values
- **Error:** Error type

1553B	Time	RTA	Type	Data	Error
1	-2.99040us	0x1	Cmd/Status	0x631	
2	27.0088us	0x1	Cmd/Status	0x0	Parity
3	47.0402us		Data	0x8888	

Figure 10.49 1553B List View

10.10 SENT Trigger and Serial Decode

This section covers triggering and decoding SENT signals. Please read the following for more details: **SENT Signal Configuration**, **SENT Trigger** and **SENT Serial Decode**.

Connect the SENT signal to the oscilloscope, set the mapping relation between the channels and the signals.

10.10.1 SENT Signal Configuration

To select the decoding **Bus Protocol**:

1. Press the Decode key or use the touchscreen controls to enter the **Decode Menu**.
2. Use the touchscreen to enable **Bus Operation**.
3. Use the touchscreen to select **Bus Protocol**.
4. The window shown in figure **10.1** will appear with the addition of the **Manchester** protocol.
5. Select the **SENT** bus protocol.

Protocol Signals

To set the source and threshold of the **SENT** signal use the touchscreen to select **Protocol Signal**:

1. The **SENT SIGNAL** menu will be displayed. (Figure **10.50**)
2. Use the touchscreen to select **Source** and select the source the signal is connected to.
3. Use the touchscreen to select **Threshold** and input the desired threshold
 - The threshold voltage level is for decoding, and it will be regarded as the trigger voltage level when the trigger type is set to serial.
 - The threshold level line only appears when adjusting the threshold level.
4. Touch  option to return previous menu.

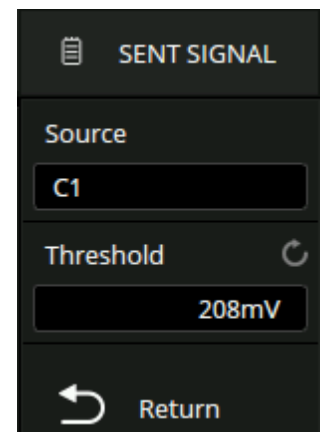



Figure 10.50
SENT Signal Menu

Protocol Config

To set the baud rate use the touchscreen to select **Protocol Config**:

1. The **SENT CONFIG** menu will be displayed. (Figure 10.51)
2. Use the touchscreen to select **Message Format**. The following formats are available:
 - **Fast Nibble**
 - **Fast Signals**
 - **Short Serial**
 - **Enhanced Serial**
3. Use the touchscreen to select **CLK**.
 - Use the **Universal Rotary Knob** or the virtual keypad to set a nominal clock period.
4. Use the touchscreen to select **Tolerance**.
 - Use the **Universal Rotary Knob** or the virtual keypad to set the percent tolerance to determine whether the sync pulse is valid for decoding the data.
5. Use the touchscreen to set the **Idle Level** to **Low** or **High**.
6. Use the touchscreen to select **# of Nibbles**.
 - Use the **Universal Rotary Knob** or the virtual keypad to set the number of nibbles.
7. Use the touchscreen to enable or disable **New CRC**.
 - CRC format will be used in calculating the correctness of the CRCs. The New CRC selection uses the 2010 CRC format. If "NEW" is not selected, the CRC will use the 2008 format. Enhanced Serial Message CRCs are always calculated using the 2010 format, but for the Fast Channel Messages, and for Short Serial Message CRCs, the chosen setting is used.
8. Use the touchscreen to enable or disable **New CRC**.
 - Specifies whether there is a pause pulse between the messages.
9. Touch  option to return previous menu.

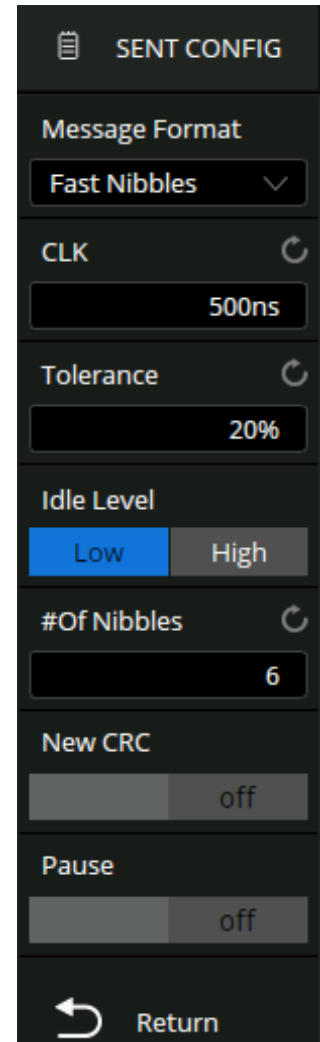



Figure 10.51
SENT CONFIG

Protocol Copy

The signal settings of decoding and triggering are independent. To synchronize the settings between decode and trigger select **Protocol Copy**.

1. The **DECODE COPY** menu will be displayed. (Figure 10.29)
2. Use the touchscreen to select **Copy To Trigger** or **Copy From Trigger**.
3. **Copy To Trigger** copies the decode settings to trigger.
4. **Copy From Trigger** copies the trigger settings to decode.
5. Touch  option to return previous menu.

Note:

The synchronization is not automatic. If the settings at one place change, a copy operation is necessary to re-synchronize.

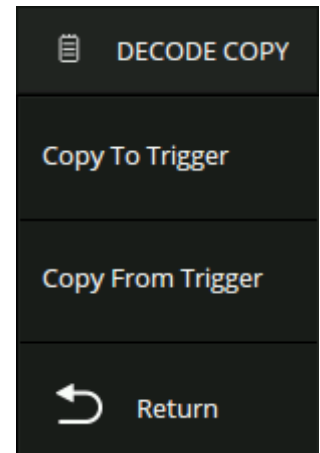



Figure 10.52 Decode Copy

10.10.2 SENT Trigger

To select **SENT Trigger**:

1. Touch the **Trigger** dialog box to display the **Trigger** menu.(Figure 10.53)
2. Touch the **Type** option and select **Serial**.
3. Use the touch screen to select **Protocol**.
 - the dropdown menu shown in figure ?? will appear.
4. Select **SENT**.

Signal

- Use the touchscreen to select **Signal**.
- Use the touchscreen to select **Source** and select the source the signal is connected to.
- Use the touchscreen to select **Threshold** and input the desired threshold
 - The threshold voltage level is for decoding, and it will be regarded as the trigger voltage level when the trigger type is set to serial.
 - The threshold level line only appears when adjusting the threshold level.
- Touch  option to return previous menu.

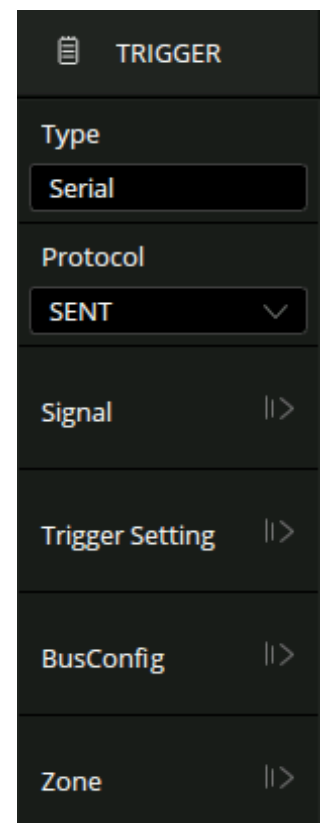

Figure 10.53 SENT Trigger

Trigger Settings

1. Use the touchscreen to select **Trigger Setting**.
2. Use the touchscreen to select **Condition**. The following conditions are available:
 - **Start:** the oscilloscope will be triggered on the start of message (after 56 synchronization ticks). You can select the type of the message: Fast Channel Message, Slow Channel Message or any.
 - **Slow Channel:** the oscilloscope will be triggered on a Slow Channel Message.
 - **Fast Channel:** the oscilloscope will be triggered on a Fast Channel Message when the Status & Communication nibble and the data nibbles match the specified values.
 - State can be selected in the hexadecimal range of 0x0 to 0xF. If the value is selected as "0xX", the state is ignored.
 - Compare Type can be specified as Equal, Not Equal, Less than, Less or Equal, Greater than, Greater or Equal, in Range of, out of Range.
 - At Pos determines the start position of the trigger data. If selected as Value, you need to set Nibble Pos in the decimal range of 0 to 5. If selected as Don't care, the oscilloscope will be triggered at the first data which matches the specified condition.
 - Nibble Len can be selected in the decimal range of 1 to 6. It is associated with the Nibble Pos.
 - Data can be selected in hex. The range is associated with the Nibble Pos. If the data is selected as "0xXX", the data is ignored.
 - **Slow Channel:** the oscilloscope will be triggered on a Slow Channel Message.
 - **Slow Type:** Select the type of slow condition.
 - **Short Serial Message:** The 16-bit message consists of a 4-bit Message ID nibble, 2 nibbles (1 byte) of data, and a CRC checksum nibble. If ID and data match, then trigger on the end of CRC bit.

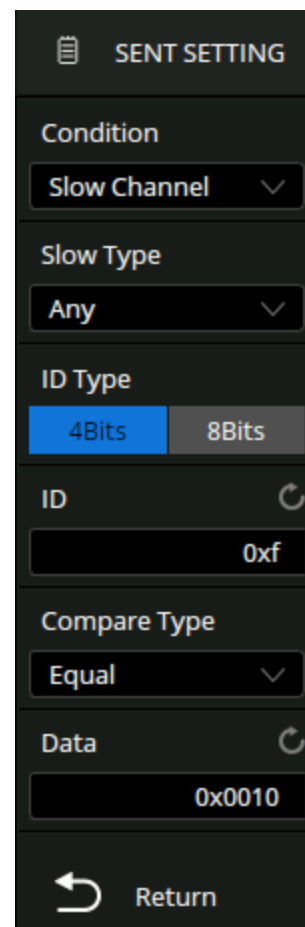

Figure 10.54 SENT Trigger Settings

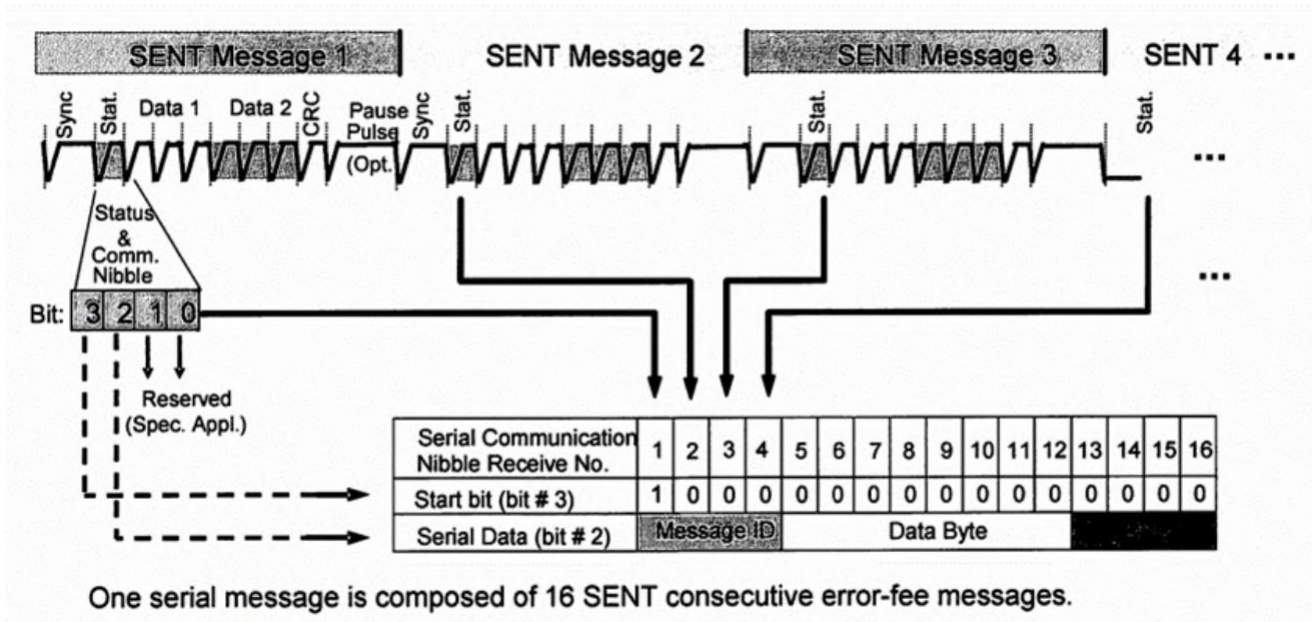

Figure 10.55 SENT Message

The serial message frame contains 21 bits of payload data. Two different configurations can be chosen determined by the configuration bit (serial data bit #3, serial communication nibble No. 8):

Enhanced Serial Message with 4bits ID: 16-bit data and 4-bit message ID, the configuration bit is 1.

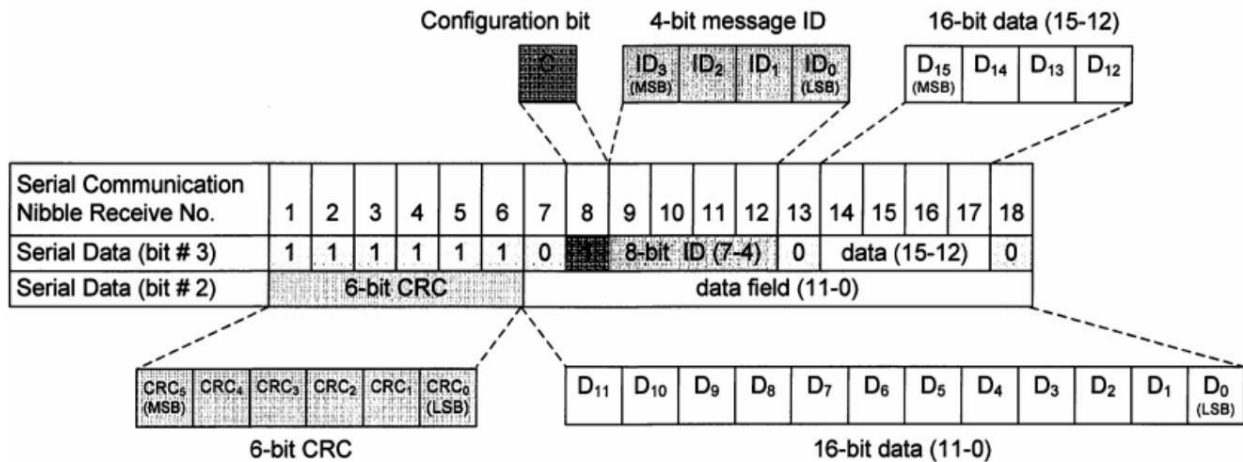

Figure 10.56 SENT Message2

Enhanced Serial Message with 8bits ID: 12-bit data and 8-bit message ID, the configuration bit is 0.

When the trigger condition is set to **Slow Channel**:

- ID can be selected in the hexadecimal range of 0x0 to 0xF (short serial / enhanced serial with 4 bits ID or 0x00 to 0xFF enhanced serial with 8 bits ID). If it is selected as "0xXX", the ID is ignored.
- Compare Type can be specified as Equal, Not Equal, Less than, Less or Equal, Greater than, Greater or Equal, in Range of, out of Range.
- Data can be selected in the hexadecimal range of 0x00 to 0xFF (short serial or 0x0000 to 0xFFFF enhanced serial with 4 bits ID or 0x0000 to 0Xfff (enhanced serial with 8 bits ID). If it is selected as "0xXX", the data is ignored.

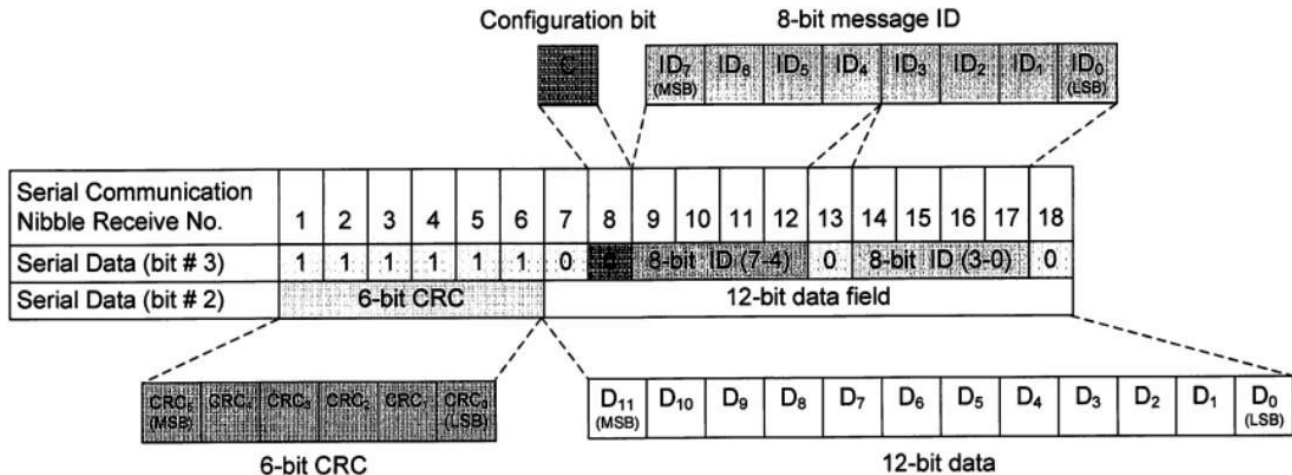

Figure 10.57 SENT Message3

- **Error:** the oscilloscope triggers on the error frame. Errors include Successive Sync Pulses Error Pulse Period Error, Fast Channel CRC Error, Slow Channel CRC Error, All CRC Errors.
- Successive Sync Pulses Error: triggers on a sync pulse whose width varies from the previous sync pulse's width by greater than 1/64 (1.5625%, as defined in the SENT specification).
- Pulse Period Error: triggers if a nibble is either too wide or too narrow (for example, data nibble < 12 (11.5) or > 27 (27.5) ticks wide). Sync, S&C, data, or checksum pulse periods are checked.
- Fast Channel CRC Error triggers on any Fast Channel Message CRC error.
- Slow Channel CRC Error triggers on any Slow Channel Message CRC error.
- All CRC Errors triggers on any CRC error, Fast or Slow.

10.10.3 SENT Serial Decode

Once the setup for the SENT signal and trigger has been completed, the decoding operation must be setup.

1. Touch Decode key to display the **Decode** menu.
2. Use the touchscreen to enable the **Bus Operation**.
3. Touch **Bus** to select either **Bus1** or **Bus2**.
4. Touch **Display** to select the character encoding format of the decoding's result.
 - The bus's vertical position can be adjusted using the **Universal Knob** after selecting **Bus Position**.
 - Touch **Format** to set the format of the bus. (Default: Hexadecimal)

Interpreting the SENT Decode

On the bus:

For Fast Channel:

- SYNC is displayed in pink
- STATE is displayed in green
- DATA is displayed in white
- CRC and Pause pulse are displayed in blue

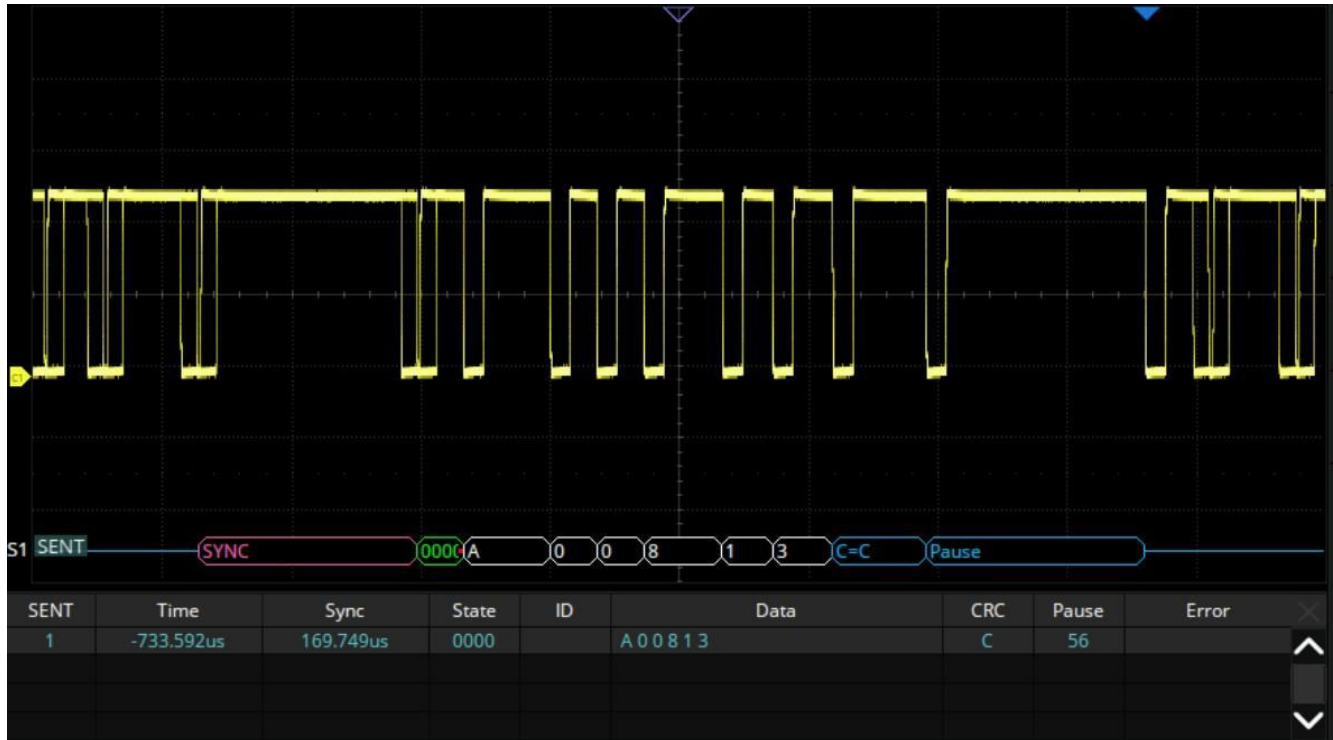

Figure 10.58 SENT Fast Channel

For Slow Channel:

- ID is displayed in green
- DATA are displayed in white
- CRC is displayed in blue

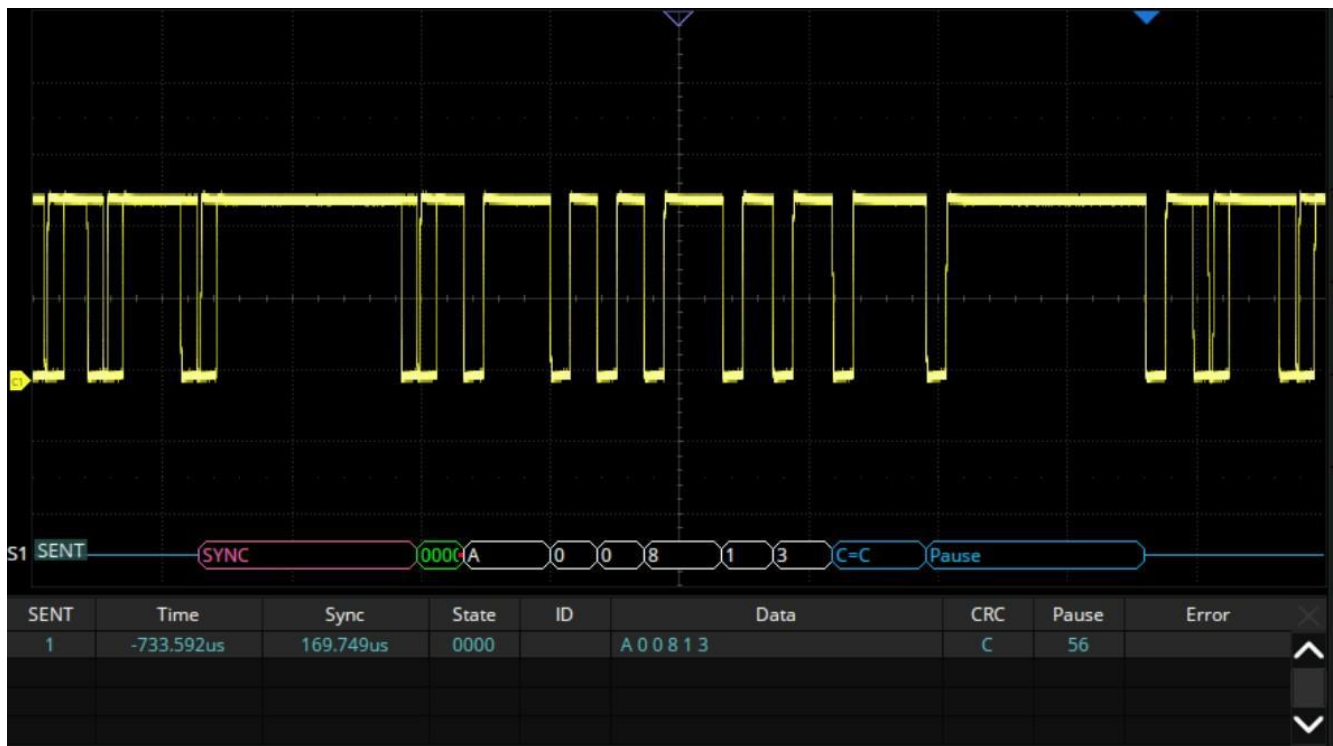

Figure 10.59 SENT Fast Channel

In the list view:

- Time: The horizontal offset of the current data frame head relative to the trigger position.
- Sync: Sync pulse width (only fast channel)
- State: Status & Communication nibble (only fast channel)
- ID: ID of the frame. (only slow channel)
- Data: Data values
- CRC: Cycle redundancy check
- Pause: Pause ticks
- Error: Error type

10.11 Manchester Trigger and Serial Decode

This section covers triggering and decoding Manchester signals. Please read the following for more details: **Manchester Signal Configuration**, SENT Trigger and **Manchester Serial Decode**.

Connect the Manchester signal to the oscilloscope, set the mapping relation between the channels and the signals.

10.11.1 Manchester Signal Configuration

To select the decoding **Bus Protocol**:

1. Press the Decode key or use the touchscreen controls to enter the **Decode Menu**.
2. Use the touchscreen to enable **Bus Operation**.
3. Use the touchscreen to select **Bus Protocol**.
4. The window shown in figure 10.1 will appear with the addition of the **Manchester** protocol.
5. Select the **SENT** bus protocol.

Protocol Signals

To set the source and threshold of the **SENT** signal use the touchscreen to select **Protocol Signal**:

1. The **Manchester SIGNAL** menu will be displayed. (Figure 10.60)
2. Use the touchscreen to select **Source** and select the source the signal is connected to.
3. Use the touchscreen to select **Threshold** and input the desired threshold
 - The threshold voltage level is for decoding, and it will be regarded as the trigger voltage level when the trigger type is set to serial.
 - The threshold level line only appears when adjusting the threshold level.
4. Touch  option to return previous menu.

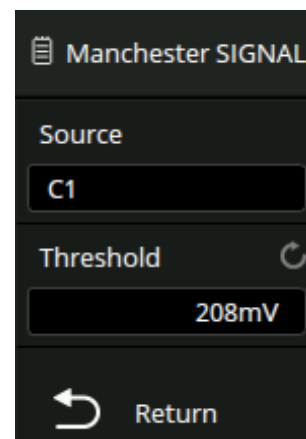



Figure 10.60
Manchester Signal Menu

Protocol Config

To set the baud rate use the touchscreen to select Protocol Config:

1. The **Manchester CONFIG** menu will be displayed. (Figure ??)
2. Use the touchscreen to select **Baud**.
 - Use the **Universal Rotary Knob** or the virtual keypad to set the baud rate, the range is 500b/s to 5Mb/s
3. Use the touchscreen to set **Polarity** to **R:1** or **F:1** .
 - R:1 indicates that rising edge is used to encode a bit value of logic 1.
 - F:1 indicates that falling edge is used to encode a bit value of logic 1.
4. Use the touchscreen to set the **Idle Level** to **Low** or **High** .
5. Use the touchscreen to select **Start Edge**.
 - Set the starting edge of the Manchester signal. The range is 1 to 32.
6. Use the touchscreen to select **Idle Bits**.
 - Set the minimum idle time/inter-frame gap time of the Manchester bus in terms of the bit width.
7. Use the touchscreen to select **Display bits**.
 - Set the display format to Byte or Bit.
8. Use the touchscreen to set the **Bit Order** to **LSB** or **MSB** .
9. Use the touchscreen to select **Sync Size**.
 - Set the sync field size, from 0 to 32.
10. Use the touchscreen to select **Header Size**.
 - Set the header size, from 0 to 32.
11. Use the touchscreen to select **# of Words**.
 - Set the number of words in data field, from 1 to 255.
12. Use the touchscreen to select **Word Size**.
 - Set the data word size, from 2 to 8
13. Use the touchscreen to select **Trailer Size**.
 - Set the trailer size, from 0 to 32.
14. Touch  option to return previous menu.

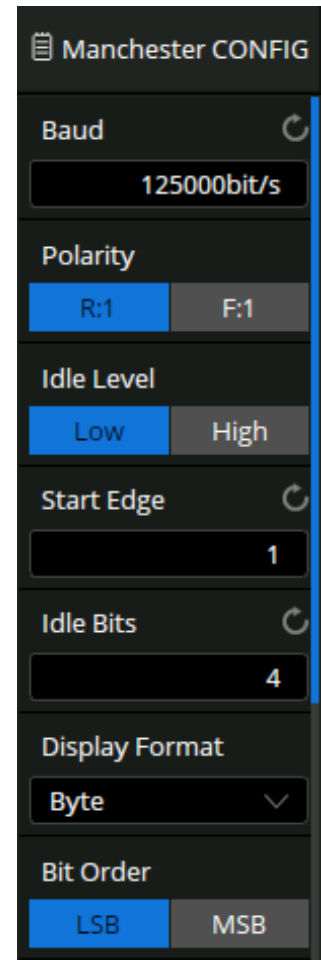



Figure 10.61
Manchester CONFIG

Protocol Copy

The signal settings of decoding and triggering are independent. To synchronize the settings between decode and trigger select **Protocol Copy**.

1. The **DECODE COPY** menu will be displayed. (Figure 10.29)
2. Use the touchscreen to select **Copy To Trigger** or **Copy From Trigger**.
3. **Copy To Trigger** copies the decode settings to trigger.
4. **Copy From Trigger** copies the trigger settings to decode.
5. Touch  option to return previous menu.

Note:

The synchronization is not automatic. If the settings at one place change, a copy operation is necessary to re-synchronize.

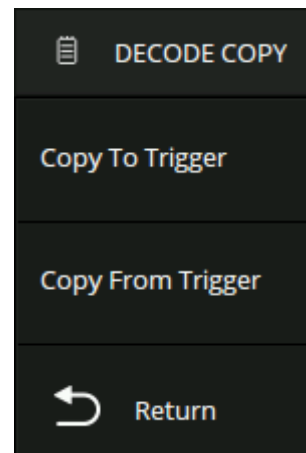

Figure 10.62 Decode Copy

10.11.2 Manchester Serial Decode

Once the setup for the Manchester signal and trigger has been completed, the decoding operation must be setup.

1. Touch Decode key to display the **Decode** menu.
2. Use the touchscreen to enable the **Bus Operation**.
3. Touch **Bus** to select either **Bus1** or **Bus2**.
4. Touch **Display** to select the character encoding format of the decoding's result.
 - The bus's vertical position can be adjusted using the **Universal Knob** after selecting **Bus Position**.
 - Touch **Format** to set the format of the bus. (Default: Hexadecimal)

Interpreting the Manchester Decode

On the bus:

- SYNC is displayed in pink
- Header is displayed in green
- DATA is displayed in white
- Trailer is displayed in blue

In the list view:

- **Time:** The horizontal offset of the current data frame head relative to the trigger position.
- **Data:** Data words
- **Error:** Error type

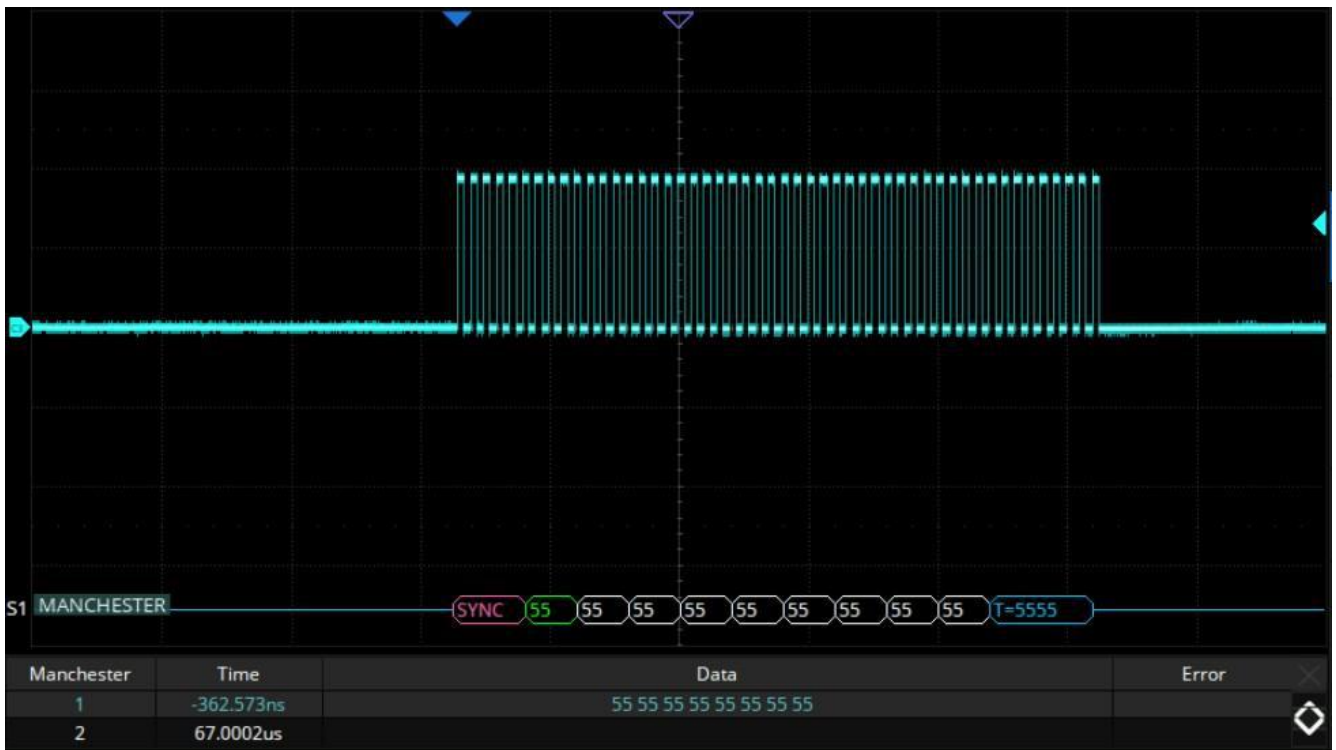

Figure 10.63 Manchester Bus

Cursors

Cursors are horizontal and vertical markers that indicate X-axis values and Y-axis values on a selected waveform source. Cursors can be used to make custom voltage and time measurements on the oscilloscope signals.

The cursor types include X1, X2, X1-X2, Y1, Y2 and Y1- Y2, used to indicate X-axis values (time or frequency) and Y-axis values (amplitude) on a selected waveform (CH1/CH2/CH3/CH4/F1/F2/REFA/REFB/REFC/REFD).

Gestures move the cursor quickly but not precisely, while the knob moves the cursor precisely but not as quickly. You can use both in combination to suit your needs: First, a rough adjustment is achieved by using gestures and then a fine adjustment is achieved by using the universal knob.

To enable Cursors:

1. Press the **Cursors** key to open the **Cursor** menu.
2. Press the **Cursors** option to toggle the function on or off.
3. Press the **Mode** option to select the desired cursor mode.
 - *Manual*: Manually set the cursors' position. Cursors type (horizontal, vertical, horizontal + vertical) is available in this mode. Figure 11.1 demonstrates manual mode with horizontal cursors.

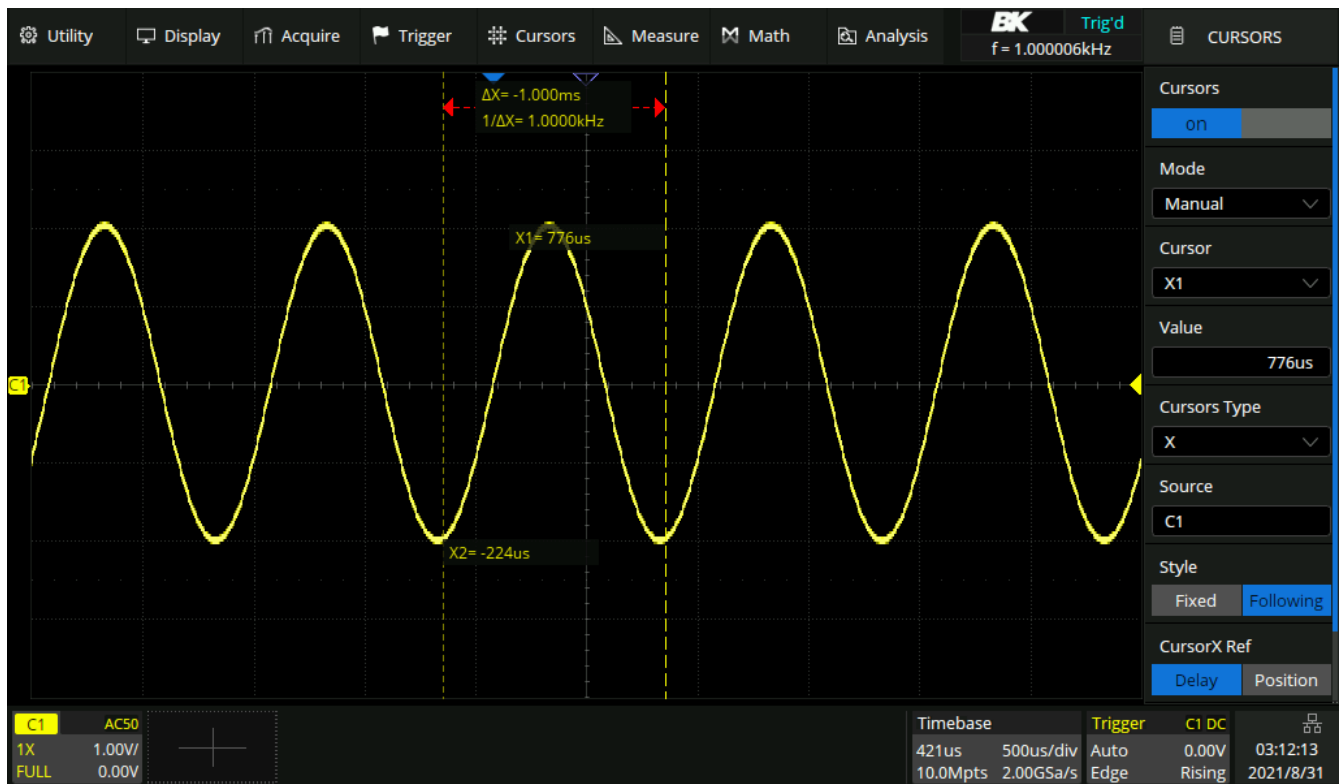

Figure 11.1 Manual Cursor Mode

- *Track*: The cursor type is automatically set to **horizontal + vertical**. In this mode, only horizontal cursors are adjustable, while the vertical cursors automatically attach to the cross-point of the cursor and the source waveform. Figure 11.2 demonstrates track mode cursors.

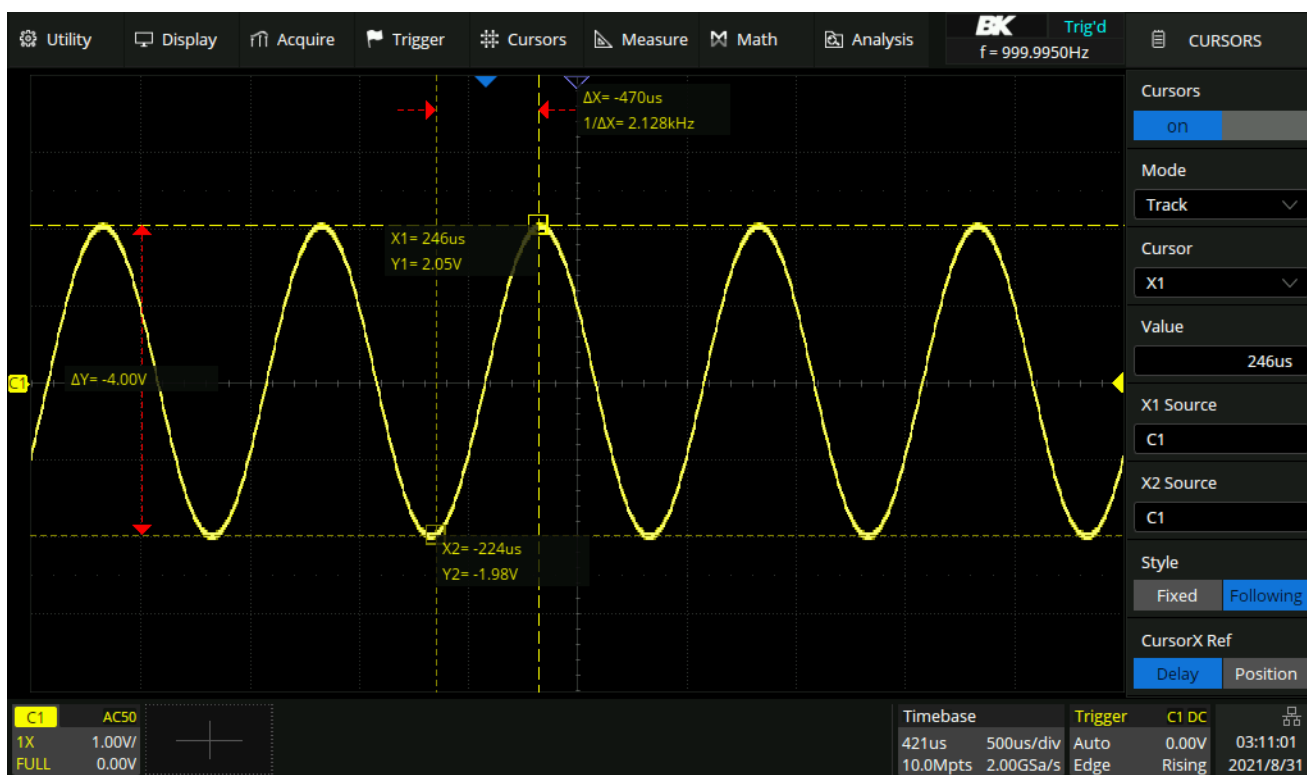

Figure 11.2 Track Cursor Mode

- **Measure**: When measurements are displayed, this mode shows the cursor locations used to make the measurement. When you add a measurement, it becomes the one that cursors are displayed for. The measurement whose cursor locations are displayed is selected in the **Measure Item** option. Figure 11.3 demonstrates measure mode with cursors measuring width.

11.1 X Cursors

X cursors are vertical dashed lines that adjust horizontally and can be used to measure time (when the source is FFT waveform, X cursors measure frequency).

X1 cursor is the left (default position) vertical dotted line; it can be moved to any place of the screen.

X2 cursor is the right (default position) vertical dotted line; it can be moved to any place of the screen.

Use the **Universal Knob** to set the X1 and X2 cursor values. The values are displayed in the cursors box along with the difference between X1 and X2 (T) and 1/T. (See figure 11.4)

When cursor type is set to X2-X1, use **Universal Knob** to move the X1 and X2 cursors together. The value under the menu option is the difference between the X1 and X2 cursors.

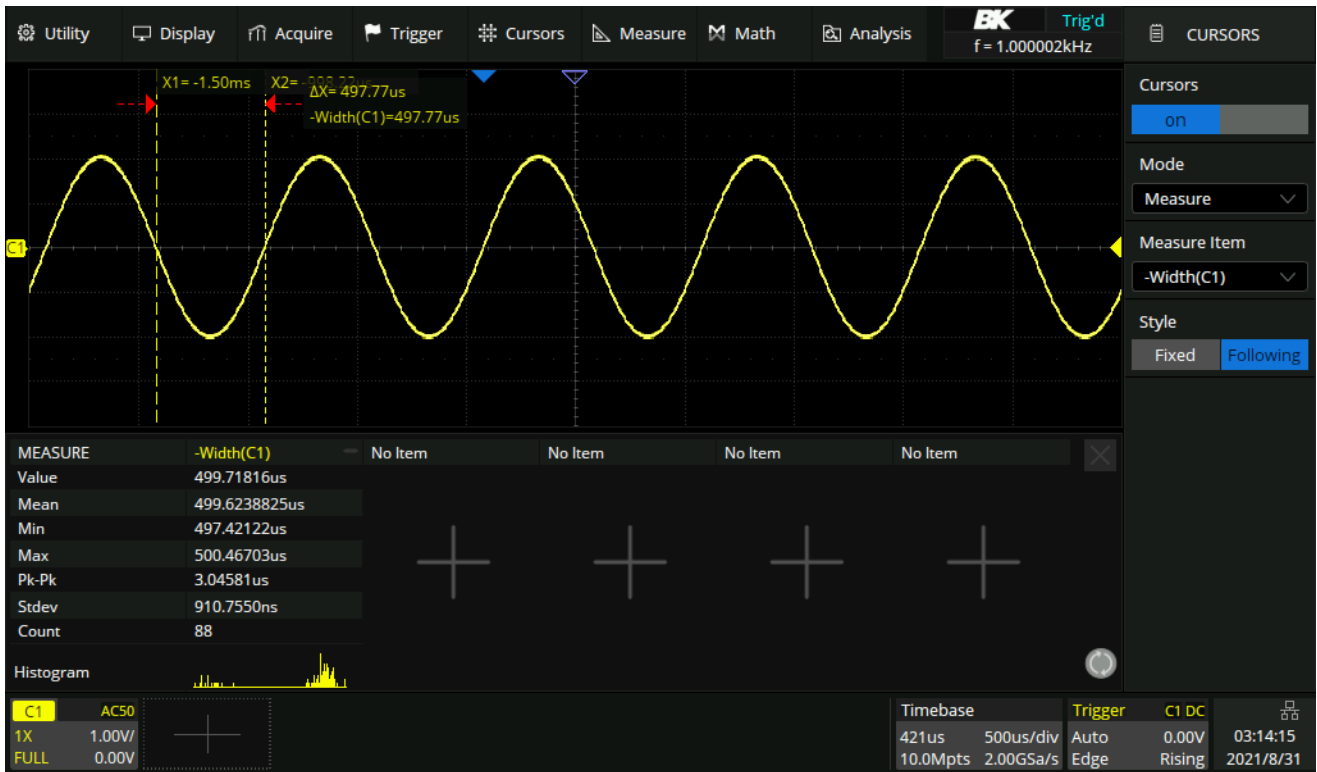

Figure 11.3 Measure Cursor Mode

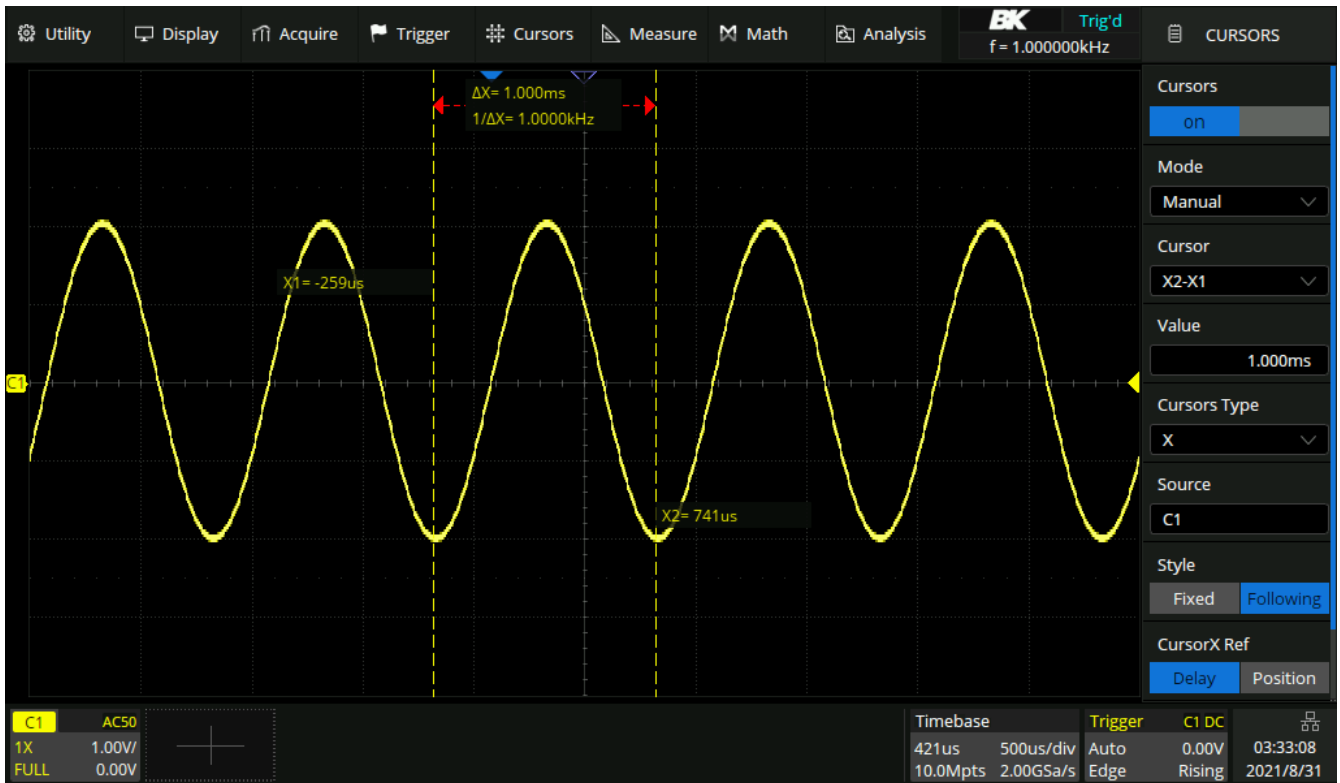

Figure 11.4 X Cursors

11.2 Y Cursors

Y cursors are horizontal dotted lines that adjust vertically and can be used to measure voltage (V) or current (A). When the cursors source is the math function, the unit will match the math function.

Y1 cursor is the top (default position) horizontal dotted line; it can be moved to any vertical place of the screen.

Y2 cursor is the down (default position) horizontal dotted line; it can be moved to any vertical place of the screen.

Use the **Universal Knob** to set the Y1 and Y2 cursor values and the values are displayed in the cursors box along with the difference between Y1 and Y2 (Y). (See figure 11.5)

When set cursor type to Y2-Y1, use Universal Knob will move the Y1 and Y2 cursors together. The value under the menu option is the difference between the Y1 and Y2 cursors.

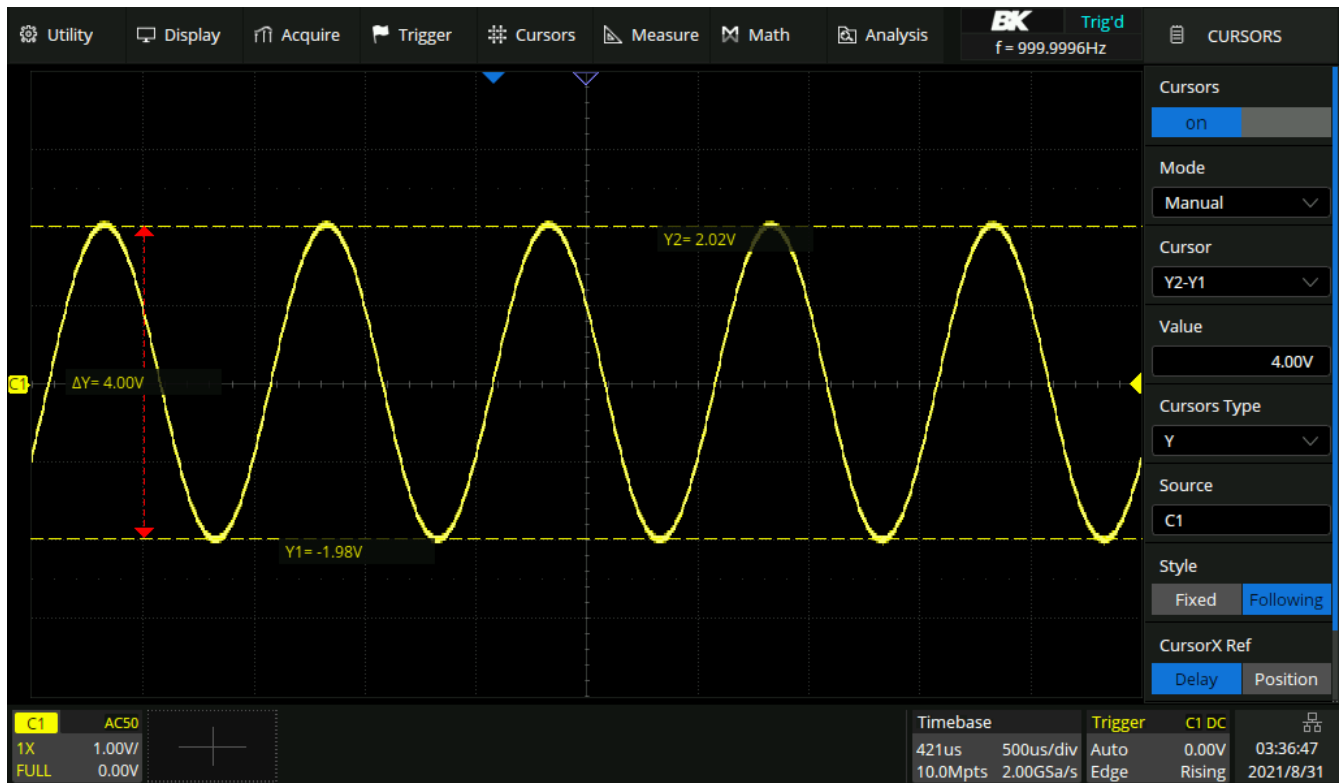

Figure 11.5 Y Cursors

11.3 Display Style

Fixed

The position information of each cursor is attached to the cursor, and the difference information is between the two cursors with arrows connected to the cursors.

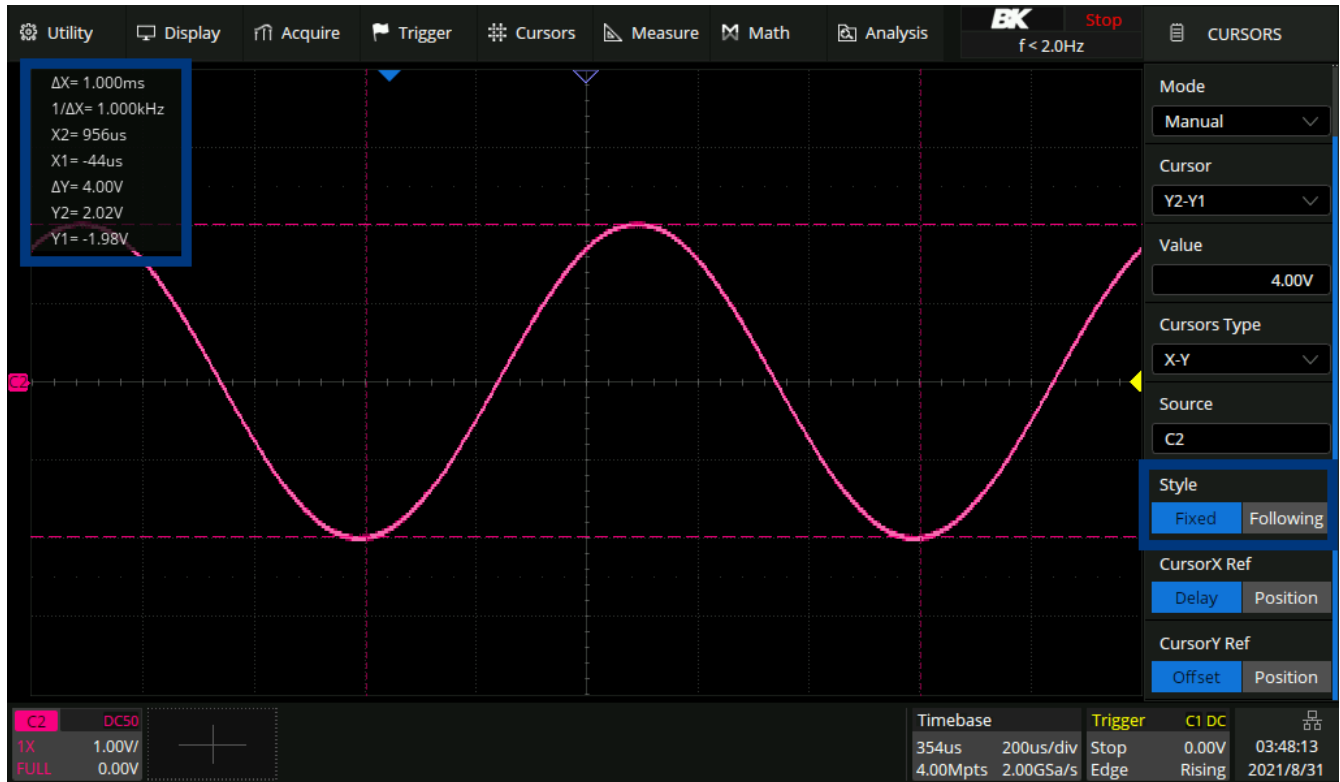

Figure 11.6 Fixed Display Style

Following

The position information of each cursor and the difference between the cursors are displayed in a region on the screen. The region can be moved by gestures to avoid covering the waveform.

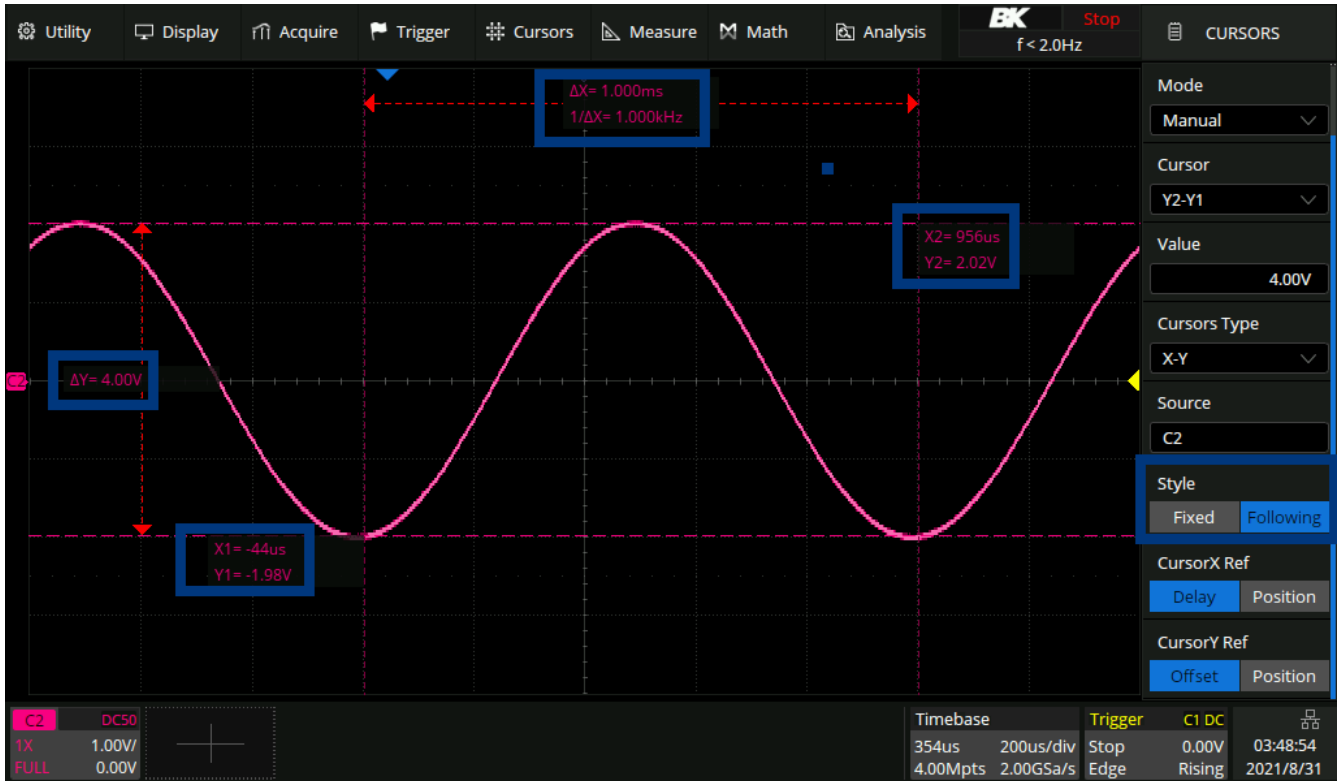

Figure 11.7 Following Display Style

11.4 Make Cursor Measurements

1. Press the **Cursors** key on the front panel to enter the CURSOR function menu.
2. Press the **Mode** softkey and set the cursors mode to Manual or Track.
3. Press the **Source** softkey, and then use the **Universal Knob** to select the desired source. Only analog channels, math waveforms and reference waveforms that are displayed are available for cursors.
4. Press the **X Ref** and **Y Ref** softkey to set the reference of X cursors and Y cursors.
 - **Position**: when the horizontal/vertical scale is changed, the X/Y cursors remain fixed to the grid position on the display.
 - **Delay/Offset**: when the horizontal/vertical is changed, the value of X/Y cursors remain fixed.
5. To make cursor measurements:
 - To measure the horizontal time, use the **Universal Knob** to move the X1 and X2 cursors to desired place. If necessary, set the cursor type to X2-X1, move X1 and X2 cursors together.
 - To measure vertical voltage or current, use the **Universal Knob** to move the Y1 and Y2 cursors to desired place. If necessary, set the cursor type to "Y2-Y1", move Y1 and Y2 cursors together.
 - To adjust the transparency of the cursors message box, press the **Display/Persist** softkey and go to the second page, press the **Transparence** (20% to 80%) softkey and then turn the **Universal Knob** to adjust the transparence to the desired value.

11.5 Cursors Reference

Cursor X Ref

- Fixed Delay: When the timebase is changed, the value of X cursors remains fixed.
- Fixed Position: When the timebase is changed, the X cursors remain fixed to the grid position on the display.

Cursor Y Ref

- Fixed Offset: When the vertical scale is changed, the value of Y cursors remains fixed.
- Fixed Position: When the vertical scale is changed, the y cursors remain fixed to the grid position on the display.

Take X cursors reference as an example to demonstrate the scaling effect of different settings:



Figure 11.8 Example 1

Timebase=50 ns/div, X1= -50 ns = -1div X2 = 100 ns = 2div



Figure 11.9 Example 2

Fixed position, timebase is changed to 100 ns/div , the grid number of X cursors (-1 div , 2 div) remains fixed. The value of X1 and X2 are changed to -100 ns , 200 ns .



Figure 11.10 Example 3

Fixed delay, timebase is changed to 100 ns/div , the value of X cursors (-50 ns , 100 ns) remains fixed. The grid number of X cursors are changed to -0.5 div , 1 div .

Measure

The oscilloscope provides measurements of 36 waveform parameters and the statistics. It contains voltage, time, and delay parameters. The 2560B series can measure multiple channels at the same time, displaying up to 5 parameter measurements with statistics while in the M1 display mode and up to 12 parameters in the M2 mode. To view more parameters on a specified channel, the **Simple** mode can be employed. For measuring waveform of interest in a time gate, the **Gate** function is suggested.

Some parameter measurements (such as the mean) are generated by all the data in a frame. Some parameter measurements (such as period) accumulate all measurements in a frame, but the displayed value is always the first value. The distribution of multiple parameters in one frame is displayed in the statistics function.

Vertical, Horizontal, and Miscellaneous measurement can be found in the **Type** option.

12.1 Measurement Modes

1. Press the **Measure** key to open the **Measure** menu.
2. Touch the **Measure** option to toggle the measure function on or off.
3. Touch the **Mode** option to toggle the measure mode between **Simple** and **Advanced**.
 - **Simple**: Displays the specified basic measurement parameters of the selected channel.



Figure 12.1 Simple Mode

Note:

If the parameter is unable to be measured, it will display as ***. Figure 12.1 demonstrates this for the CCJ measurement

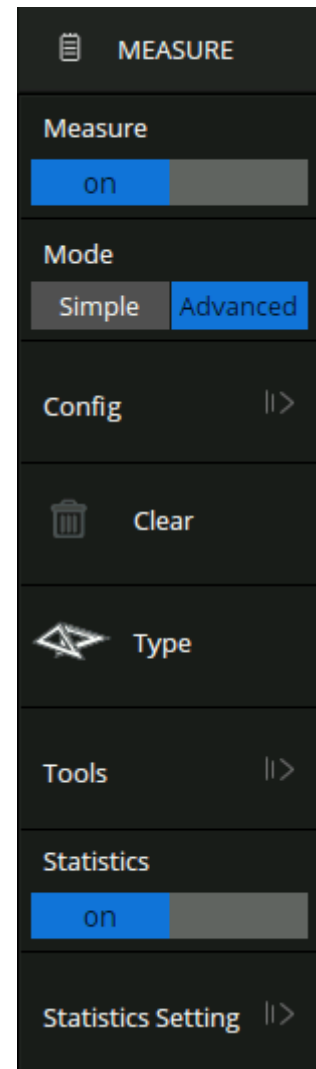

Figure 12.2 Measure Menu

- **Advanced:** Advanced mode has two display modes **M1** and **M2**.
 - To toggle between **M1** and **M2** touch **Config** while advanced mode is selected.
 - Touch **Display Mode** to toggle between **M1** and **M2** mode.
 - a. **M1:** Displays a maximum of 5 specified basic measurement parameters of the selected channel. **Statistics** and **Histogram** are available for M1 display.



Statistics and Histogram Enabled



Statistics and Histogram Disabled

Figure 12.3 Advanced M1 Mode

- b. **M2:** Displays a maximum of 12 specified basic measurement parameters of the selected channel. Only **Statistics** is available for M2 display.



Statistics Enabled



Statistics Disabled

Figure 12.4 Advanced M2 Mode

12.2 Set Measurement Types

To add a measurement in **Advanced** mode:

1. Touch the **Type** option in the measure menu, or touch the + in the measurement parameters and statistics display area.
 - The **Measure Select** window will be displayed. See figure 12.5

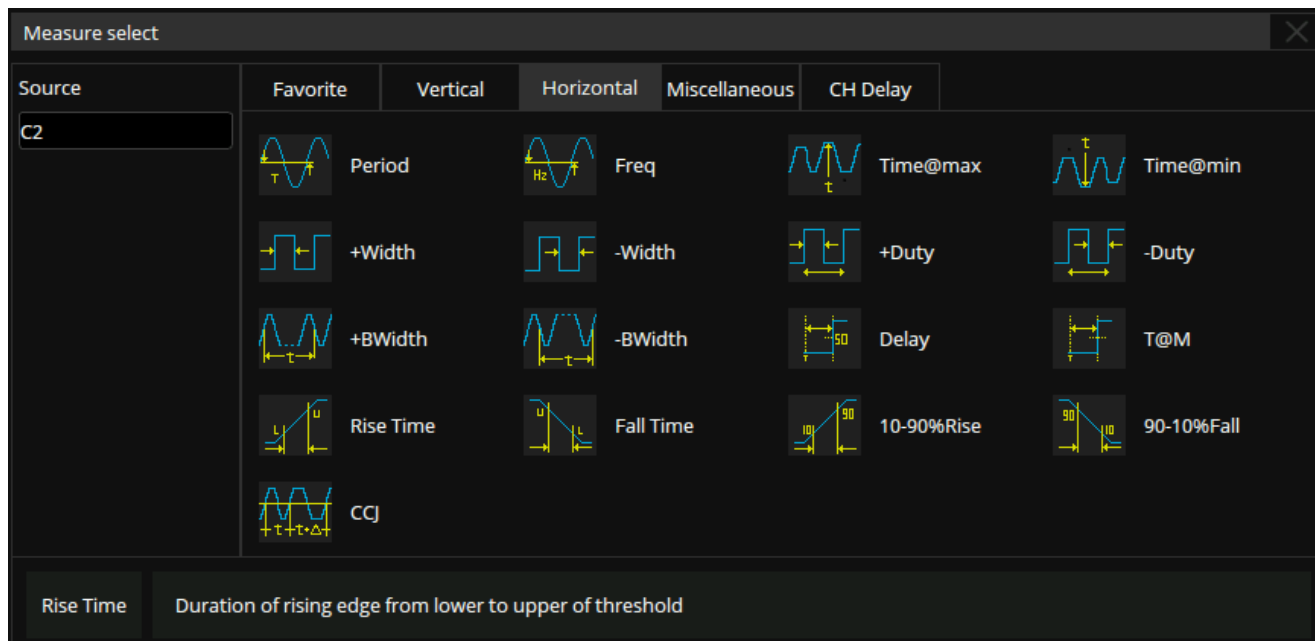

Figure 12.5 Measure Select

2. Set the Source of the current setting.
3. Select the tab that include the desired measurement.
 - The corresponding parameters of the selected tab will be displayed below the tab area.
4. Use the touchscreen to select the desired measurement.

Note:

A source must be selected before selecting a measurement. For delay measurements the channel corresponding to Source A is specified first, and then the channel corresponding to Source B. Finally, the measurement parameter is selected.

5. To remove single measurements, touch the - in the upper right corner of the measurement.
6. To remove all measurements simultaneously touch the **Clear** option in the measure menu.

12.3 Type of Measurement

12.3.1 Vertical Measurements

Vertical measurements include 19 measurements.

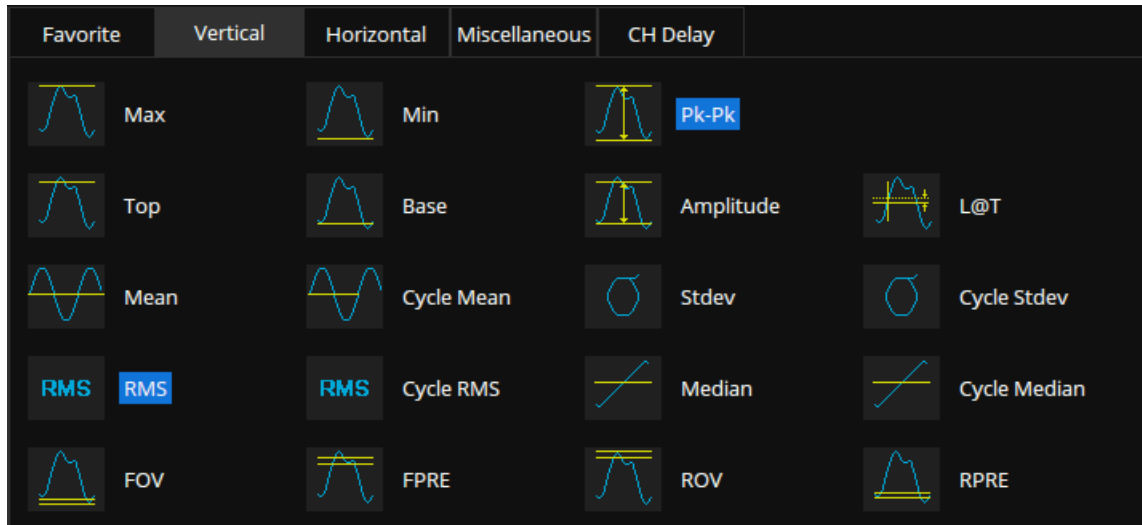

Figure 12.6 Vertical parameters

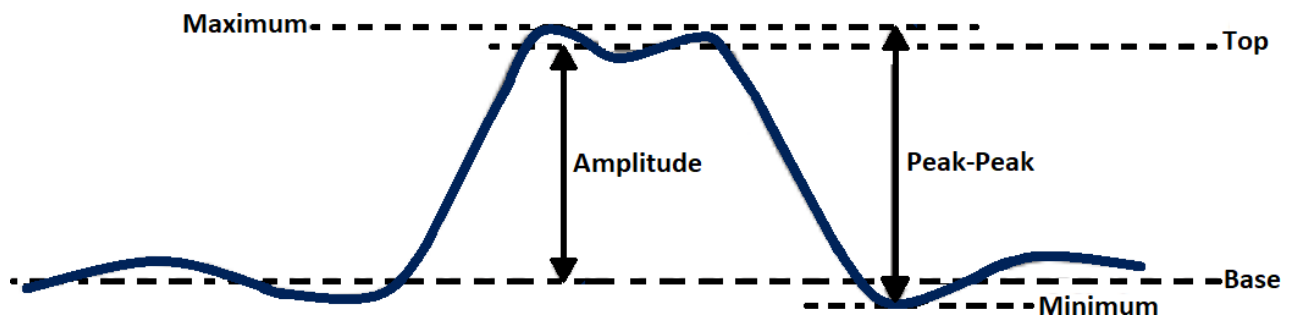

Figure 12.7 Vertical Measurements

1. **Maximum:** Highest value in input waveform.
2. **Minimum:** Lowest value in input waveform.
3. **Peak-Peak:** Difference between maximum and minimum data values.
4. **Top:** Value of most probable higher state in a bimodal waveform.
5. **Base:** Value of most probable lower state in a bimodal waveform.
6. **Amplitude:** Difference between top and base in a bimodal signal, or between max and min in a unimodal signal.
7. **Mean:** Average of all data values.
8. **Cycle mean:** Average of data values in the first cycle.
9. **Stdev:** Standard deviation of all data values

10. **Cycle Stdev**: Standard deviation of all data values in the first cycle
11. **Rms**: Root mean square of all data values.
12. **Cycle RMS**: Root mean square of all data values in the first cycle.
13. **Median**: Value at which 50% of the measurements are above and 50% are below.
14. **Cycle Median**: Median of the first cycle.
15. **Overshoot (FOV and ROV)**: Overshoot is distortion that follows a major edge transition expressed as a percentage of Amplitude. ROV means rising edge overshoot and FOV means falling edge overshoot.

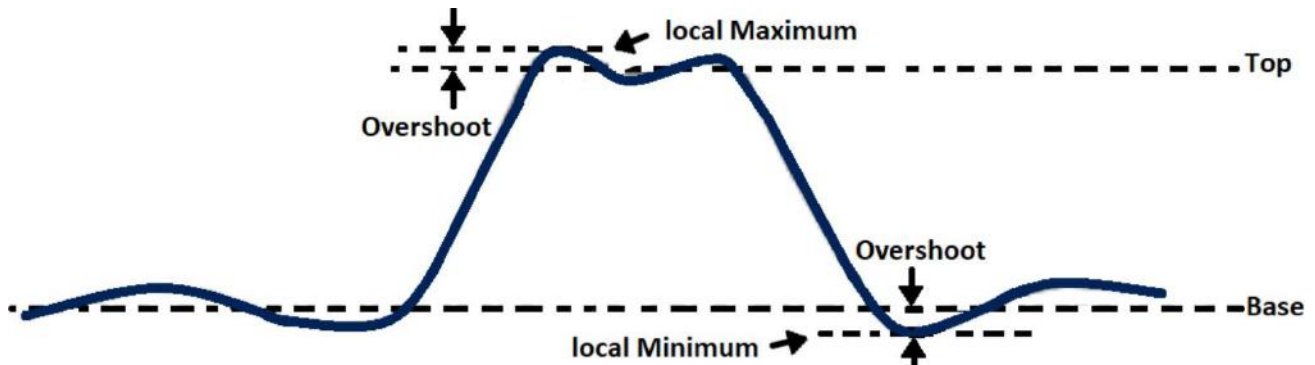

Figure 12.8 Overshoot

$$\text{Rising edge overshoot} = \frac{\text{local Maximum} - D \text{ Top}}{\text{Amplitude}} \times 100$$

$$\text{Falling edge overshoot} = \frac{\text{Base} - D \text{ local Minimum}}{\text{Amplitude}} \times 100$$

16. **Preshoot (FPRE and RPRE)**: Preshoot is distortion that precedes a major edge transition expressed as a percentage of Amplitude. The X cursors show which edge is being measured (edge closest to the trigger reference point).

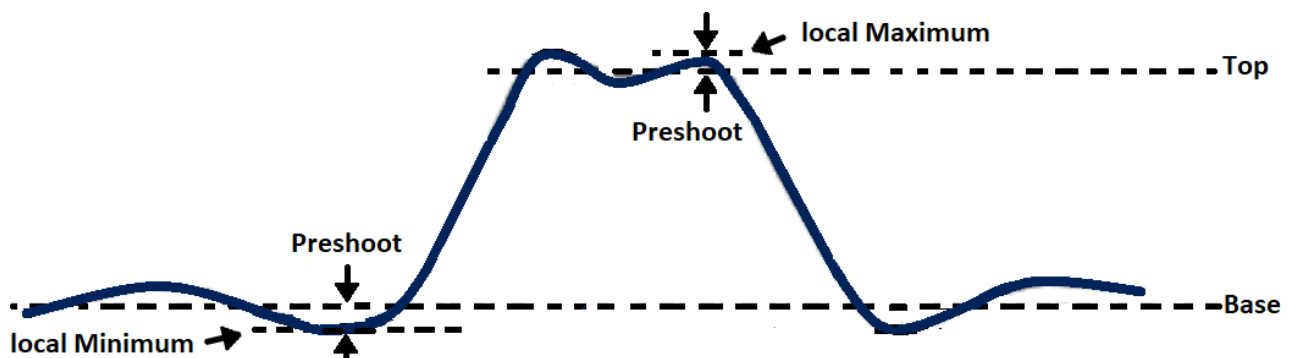

Figure 12.9 Preshoot

$$\text{Rising edge preshoot} = \frac{\text{local Minimum} - D \text{ Top}}{\text{Amplitude}} \times 100$$

$$\text{Falling edge preshoot} = \frac{\text{Base} - D \text{ local Maximum}}{\text{Amplitude}} \times 100$$

17. **Level@X**: The voltage value between the trigger point and the vertical position of the channel

12.3.2 Horizontal Measurements

Horizontal measurements include 17 types of parameter measurements.

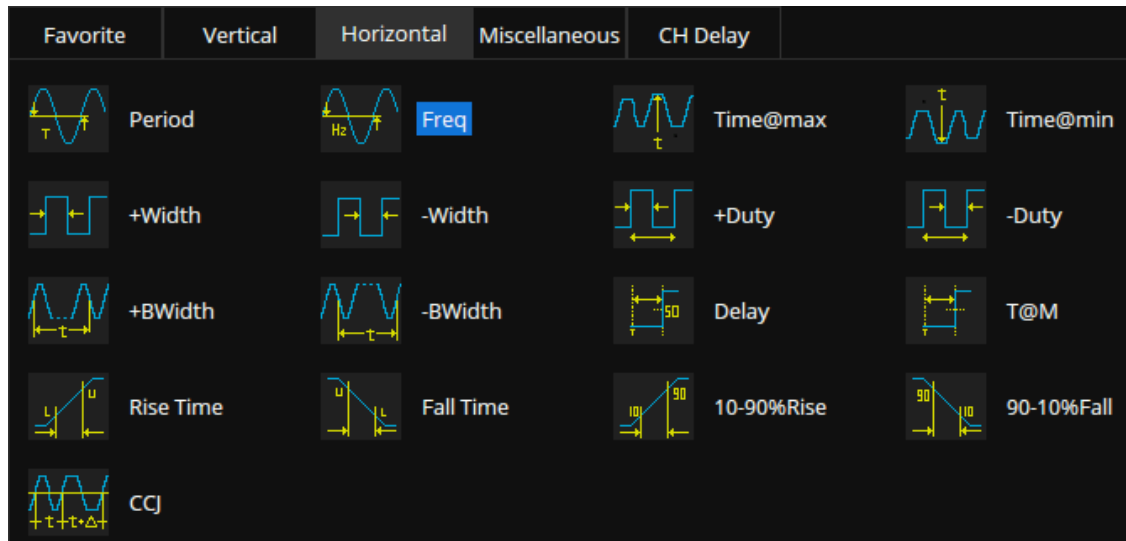

Figure 12.10 Horizontal parameters

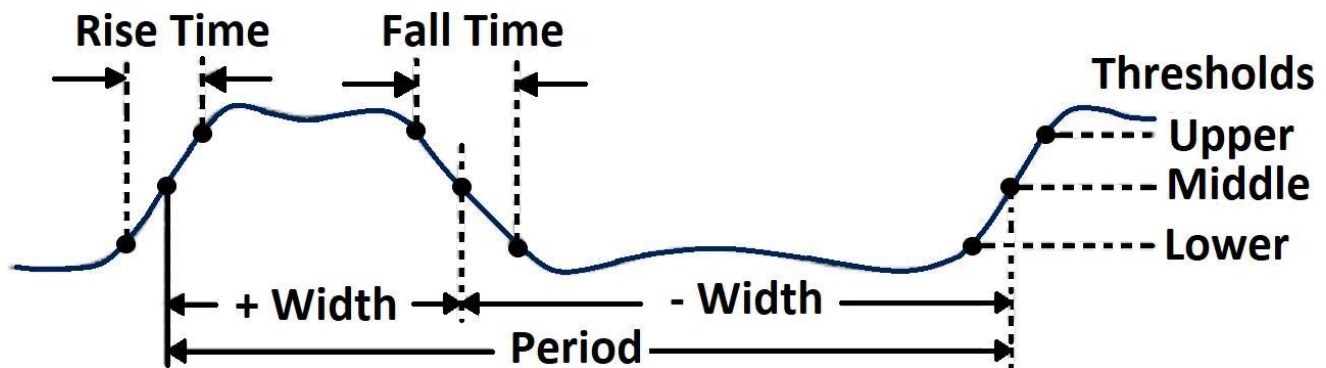

Figure 12.11 Horizontal Measurements

1. **Period**: Period for every cycle in waveform at the 50% level, and positive slope.
2. **Frequency**: Frequency for every cycle in waveform at the 50% level, and positive slope.
3. **Time@max**: Time of maximum value.
4. **Time@min**: Time of minimum value.
5. **+ Width**: Width measured at 50% level and positive slope.
6. **- Width**: Width measured at 50% level and negative slope.
7. **+ Duty**: Ratio of positive width to period.
8. **- Duty**: Ratio of negative width to period.
9. **BWidth**: Time from the first rising edge to the last falling edge, or the first falling edge to the last rising edge at the 50% crossing.
10. **Delay**: Time from the trigger to the first transition at the 50% crossing.
11. **T@M**: Time from the trigger to reach rising edge at the middle threshold.

12. **Rise Time:** Duration of rising edge from 10-90%.
13. **Fall Time:** Duration of falling edge from 90-10%.
14. **10-90% Rise:** Duration of rising edge from 10-90%.
15. **90-10% Fall:** Duration of falling edge from 90-10%.
16. **CCJ:** The difference between two consecutive periods.

12.3.3 Miscellaneous Measurements

Miscellaneous measurements include 14 types of parameter measurements.

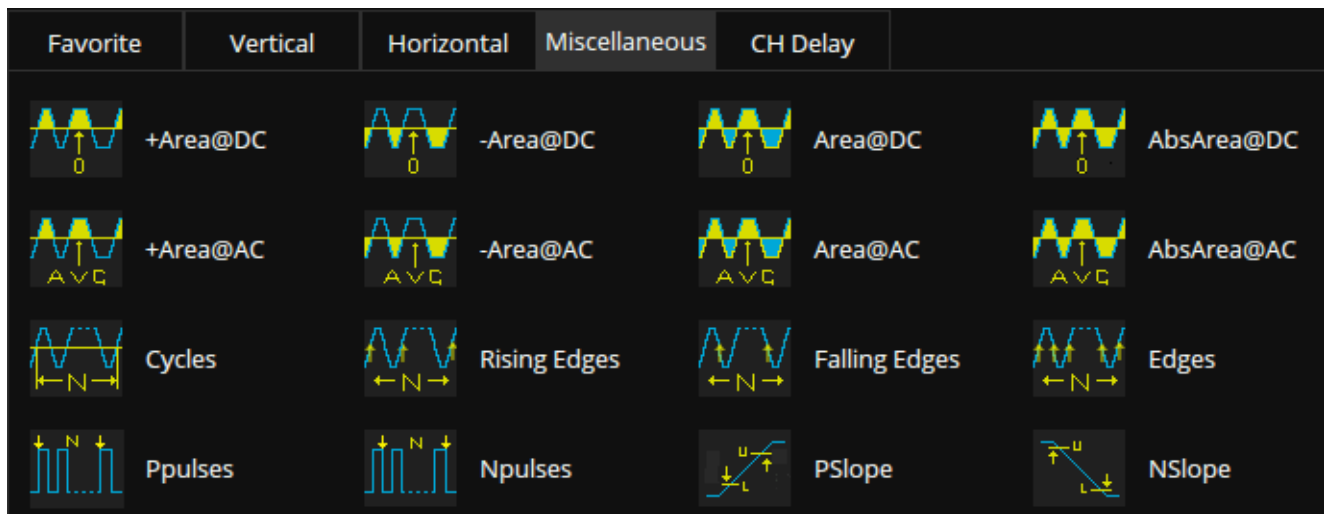

Figure 12.12 Miscellaneous Measurements

1. **+Area@DC:** Area of the waveform above zero.
2. **-Area@DC:** Area of the waveform below zero.
3. **Area@DC:** Area of the waveform.
4. **AbsArea@DC:** Absolute area of the waveform.
5. **+Area@AC:** Area of the waveform above average.
6. **-Area@AC:** Area of the waveform below average.
7. **Area@AC:** Area of the waveform above average minus area of the waveform below average.
8. **AbsArea@AC:** Area of the waveform above average add area of the waveform below average.
9. **Cycles:** Number of cycles in a periodic waveform.
10. **Rising Edges:** Number of rising edges in a waveform.
11. **Falling Edges:** Number of falling edges in a waveform.
12. **Edges:** Number of edges in a waveform.
13. **Ppulses:** Number of positive pulses in a waveform.
14. **Npulses:** Number of negative pulses in a waveform.

12.3.4 Delay Measurements

Delay measurement measures the time difference between two channels. It includes 10 delay parameters:

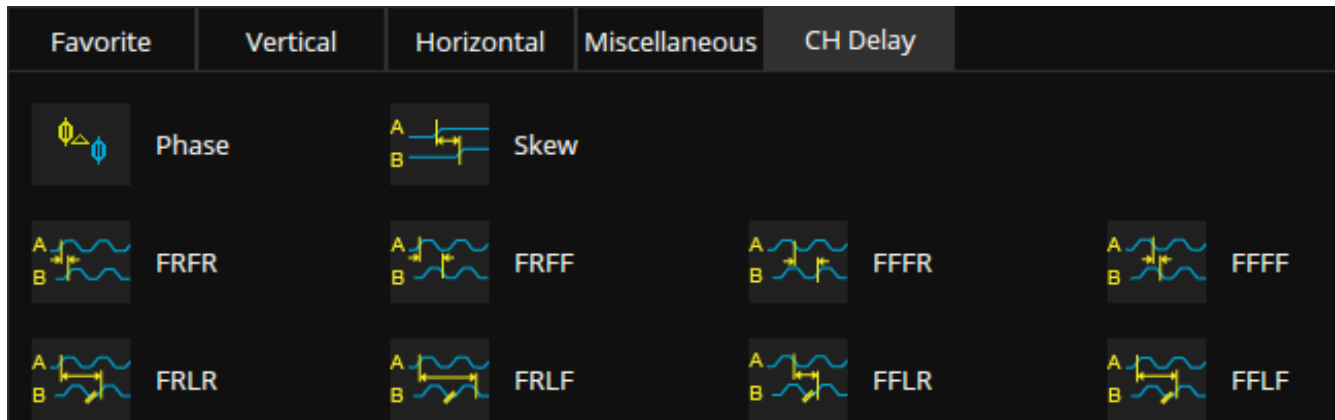

Figure 12.13 CH Delay Measurements

1. **Phase:** Phase difference between two edges.
2. **Skew:** Time of source A edge minus time of nearest source B edge.
3. **FRFR**The time between the first rising edge of source A and the following first rising edge of source B at the middle threshold.
4. **FRFF**The time between the first rising edge of source A and the following first falling edge of source B at the middle threshold.
5. **FFFR**The time between the first falling edge of source A and the following first rising edge of source B at the middle threshold.
6. **FFFF**The time between the first falling edge of source A and the following first falling edge of source B at the middle threshold.
7. **FRLR**The time between the first rising edge of source A and the last rising edge of source B at the middle threshold.
8. **FRLF**The time between the first rising edge of source A and the last falling edge of source B at the middle threshold.
9. **FFLR**The time between the first falling edge of source A and the last rising edge of source B at the middle threshold.
10. **FFLF**The time between the first falling edge of source A and the last falling edge of source B at the middle threshold.

12.4 Trend

After adding a measurement parameter, trend can be used to observe the change of the selected measurement value over time.

To enable to trend operation:

1. Touch the **Tools** option in the measure menu.
2. Touch the **Trend** option to display the dropdown menu with the available options.
3. Select the desired measurement.
4. Press the **Clear Sweep** key or touch the **Reset Statistics** option in the measure menu, or touch the  icon in the statistics display area to clear and restart statistics.



Figure 12.14 Trend

12.5 Simple Measurements

Enabling Simple Measurement displays all selected measurement parameters of the specified channel at the same time. The font color of the measurement parameters is consistent with the color of the specified source. Yellow for Channel 1, Purple for Channel 2, etc.

Max	2.067V	Min	-2.033V	Pk-Pk	4.100V	Top	2.067V
Base	-2.033V	Amplitude	4.100V	L@T	-33mV	Mean	18.49mV
Cycle Mean	18.30mV	Stdev	1.42123V	Cycle Stdev	1.42114V	RMS	1.42135V
Cycle RMS	1.42126V	Median	33mV	Cycle Median	33mV	FOV	0.000%
FPRE	0.000%	ROV	0.000%	RPRE	0.000%	Period	1.00001500ms
Freq	999.9850051Hz	Time@max	231.43350us	Time@min	-262.41900us	+Width	501.04596us
-Width	498.96904us	+Duty	50.104%	-Duty	49.896%	+BWidth	501.26692us
-BWidth	1.49879955ms	Delay	-496.04867us	T@M	1.00275088ms	Rise Time	303.05996us
Fall Time	297.52952us	10-90%Rise	303.05996us	90-10%Fall	297.52952us	CCJ	***
+Area@DC	1.29927mWb	-Area@DC	1.26228mWb	Area@DC	36.99uWb	AbsArea@DC	2.56155mWb
+Area@AC	1.28073mWb	-Area@AC	1.28055mWb	Area@AC	0.19uWb	AbsArea@AC	2.56128mWb
Cycles	1	Rising Edges	2	Falling Edges	2	Edges	4
Ppulses	1	Npulses	2	PSlope	11mV/us	NSlope	11mV/us

Figure 12.15 Simple Measurement

12.6 Measurement Statistics

To toggle statistics on and off touch the **Statistics** option in the measure menu.

Enabling statistics displays the distribution of the measured values of every selected parameter.

MEASURE	Pk-Pk(C1)	RMS(C1)	Pk-Pk(C2)	RMS(C2)	Freq(C1)
Value	5.067V	1.77306V	6.067V	2.12323V	1.0000759kHz
Mean	5.06667V	1.7730579V	6.06667V	2.1232252V	1.000075943kHz
Min	5.067V	1.77306V	6.067V	2.12323V	1.0000759kHz
Max	5.067V	1.77306V	6.067V	2.12323V	1.0000759kHz
Pk-Pk	0.000V	0.00000V	0.000V	0.00000V	0.0000000kHz
Stdev	0V	0V	0V	0V	0Hz
Count	1	1	1	1	1

Figure 12.16 Statistics Enabled

- **Value:** The current measurement.
- **Mean:** Average of all historical measurements.
- **Min:** The minimum of all historical measurements.
- **Max:** The maximum of all historical measurements.
- **Stdev:** Standard deviation of all historical measurements.
- **Count:** The number of historical measurements.

Press the **Clear Sweep** key or touch the **Reset Statistics** option in the measure menu, or touch the  icon in the statistics display area to clear and restart statistics.

12.7 Statistics Histogram

After enabling statistics on a selected measurement, activate a statistical histogram. The histogram appears at the bottom of the statistics area. This enables users to quickly view the probability distribution of the measured parameters.

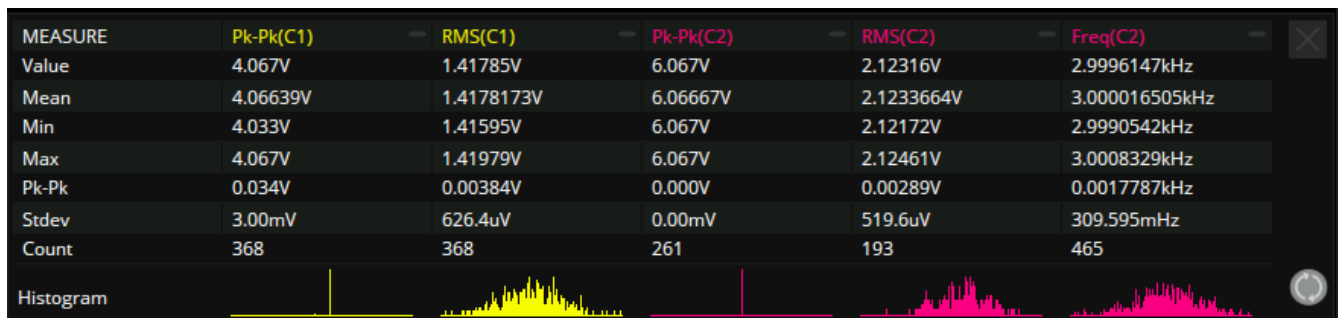

Figure 12.17 Histogram Enabled

Touch the histogram area of a parameter to enlarge it for details. Move the large histogram window position around the display by dragging. Touch the histogram of another parameter to switch to the corresponding enlarged histogram.

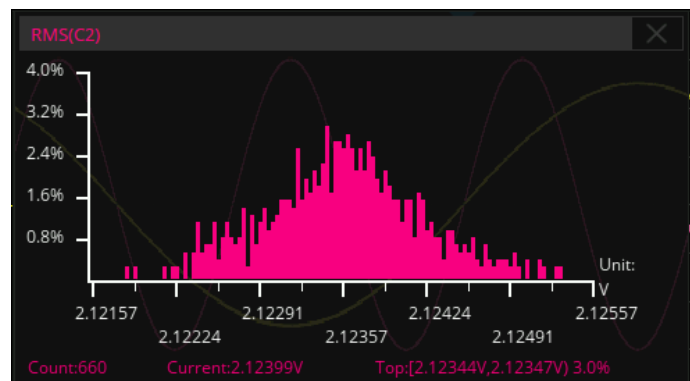

Figure 12.18 Histogram Enlarged

12.8 Gate

The **Gate** function is useful to measure parameters for a certain specified time range of the signal and ignore signal parts that lie outside of that range.

To configure the gate function:

1. Touch the **Gate** option in the measure config menu to toggle the function on and off.
 - When enabled the gate settings will appear in the measure config menu. See figure 12.19
2. Set gate cursors A and B.
 - These cursors define the range of time for parameter measurements. The oscilloscope will only measure the parameters of the data between A and B.
3. Touch the **Gate A-B** option and use the **Universal Knob** to move the position of the gate.
 - The drag gesture can also be used on the touchscreen to move the position of the gate.

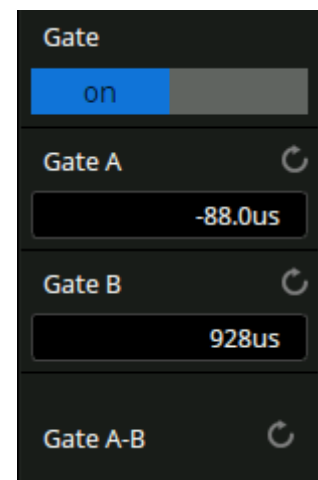

Figure 12.19 Gate Menu

Figure 12.20 shows a scenario in which the gate function is used to measure the pea-peak parameter of an amplitude modulated waveform.

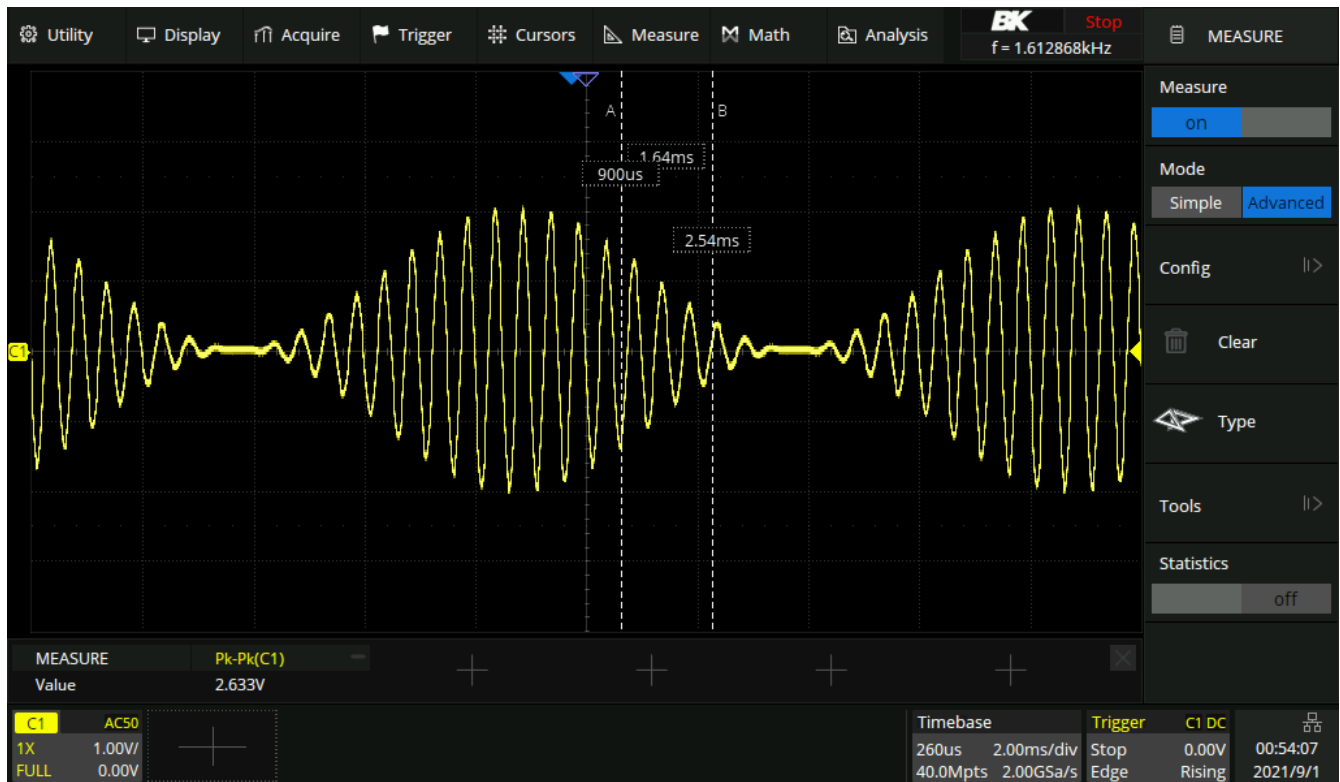

Figure 12.20 Gate Example

12.9 Amplitude Strategy

According to different types of input signals, choosing the corresponding amplitude calculation strategy which can make the measurement of top value and bottom values more accurate.

To set an amplitude strategy:

1. Touch the **Config** option in the measure menu.
2. Touch the **Amplitude Strategy** in the measure config menu.
 - The **Amplitude Strategy** menu shown in figure 12.21 will be displayed.
3. Set the amplitude calculation strategy. When set to auto, the amplitude calculation strategy will be selected automatically according to the input signal to ensure the accuracy of the measured value.
4. Set the top value calculation strategy. When set to histogram, the value greater than half of peak value will be counted, and the value with the maximum probability will be identified as the top value; when set to max, the maximum value of waveform will be identified as the top value.
5. Set the base value calculation strategy. When set to histogram, the value less than half of peak value will be counted, and the value with the maximum probability will be identified as the base value; when set to min, the minimum value of waveform.

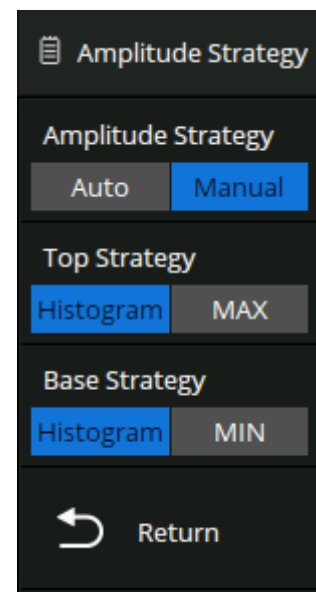

Figure 12.21 Amplitude Strategy

12.10 Threshold

Measurement thresholds can be defined by the user. This is more flexible than fixed thresholds. For example, for pulse width measurement, the threshold can be specified rather than fixed at 50%. For rise time, the lower / upper thresholds can be specified rather than fixed at 10%/90%.

Changing the default threshold may change the measurement results of relevant measurement items, such as: Period, frequency, +width, -width, +duty, -duty, +BWidth, -BWidth, delay, T@M, rise time, fall time, CCJ, cycles, rising edges, falling edges, edges, Ppulses, Npulses, and delay measurement.

To configure the measurement threshold:

1. Touch the **Config** option in the measure menu.
2. Touch the **Threshold** in the measure config menu.
 - The **Measure Threshold** menu shown in figure 12.22 will be displayed.
3. Set the type of threshold
 - **Percent**: Set according to the percentage of waveform. The setting range of lower value and upper value is 1% ~ 99%, and the low value shall not be greater than the middle value and high value
 - **Absolute**: Set according to the vertical range. The absolute threshold value depends on the vertical scale, offset and probe attenuation. These values should be set before setting absolute thresholds. Lower and upper values are limited to the range of screen. If any absolute threshold is greater or less than the minimum or maximum waveform value, the measurement may be invalid.
4. Touch the **Upper** option and use the **Universal Knob** or the virtual key pad to set the upper value.
5. Touch the **Middle** option and use the **Universal Knob** or the virtual key pad to set the middle value.
6. Touch the **Lower** option and use the **Universal Knob** or the virtual key pad to set the lower value.

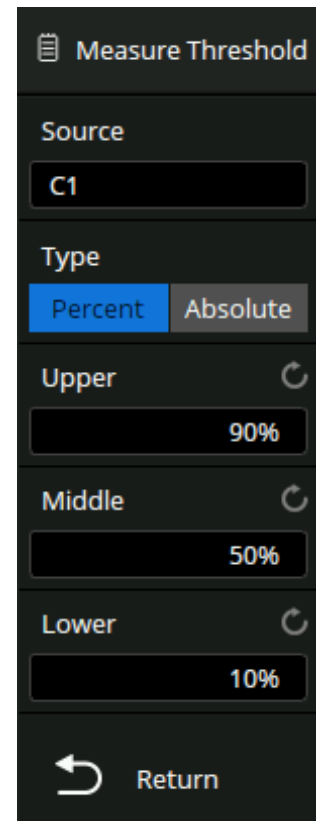

Figure 12.22
Measure Threshold

Math

The 2560B series supports two math traces and multiple math operations.

Arithmetic operators include: addition (+), subtraction (-), multiplication (*), division (/), average, Eres, identity, and negation.

Algebra operators include: differential (d/dt), integral ($\int dt$), square root ($\sqrt{\quad}$), absolute ($|\quad|$), sign, exp, exp10, ln, lg, interpolate; and FFT, as well as a formula editor.

The math traces are labeled with an "F1" and "F2" icon and can be measured by the cursors or as the source of auto measurement.

Note:

If the analog channel or the math function is cut off (waveforms do not display on the screen completely), the resulting math will also be cut off.

To configure a math function:

1. Press the **Math** key, or touch the  icon in the channel descriptor box region and select **Func1** or **Func2**.
 - The **Math** menu shown in figure 13.1 will be displayed.
2. Touch the **Operation** option to toggle the math function on and off.
3. Touch trace to select the function to be configured (**Function1** or **Function2**)
4. Touch the **Function** option to display the available functions.
 - The **Function** window shown in figure 13.2 will be displayed.
5. Touch the **Scale** option to adjust the scale of the selected function with the **Universal Knob**.
6. Touch the **Label** option open the label menu.
 - In the **Label** menu the selected function's label can be enabled or disabled, and modified.
7. Touch the **Position** option to adjust the vertical position of the selected function with the **Universal Knob**.
8. Touch the **Invert** option to toggle the invert function on and off.

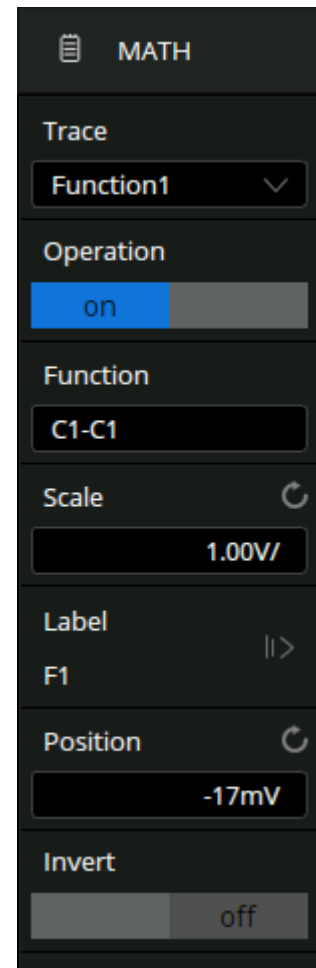

Figure 13.1 Math Menu

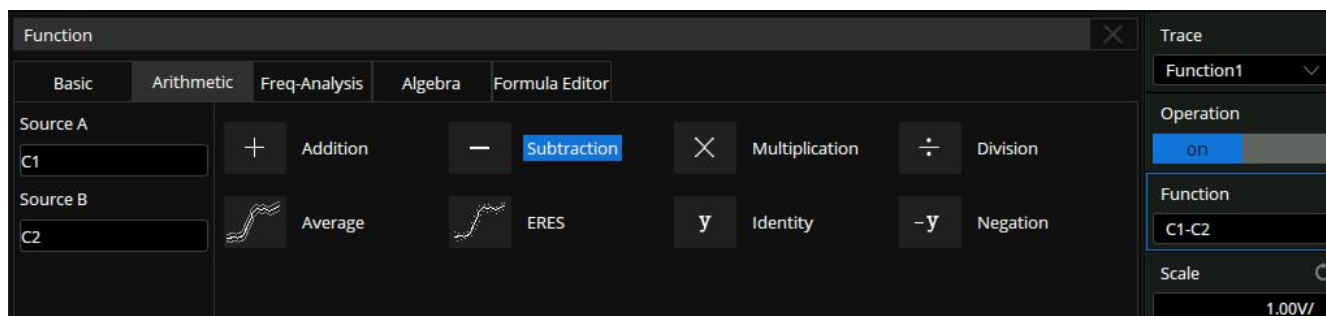

Figure 13.2 Function Window

13.1 Units for Math Waveforms

Use the channel function menu to set the unit of each channel to "V" or "A".

The oscilloscope math operation includes units as below:

Math	Operation Unit
Addition (+) or Subtraction (-)	V, A, or U* *(used when the units of two sources are not consistent)
multiplication (x)	V^2 , A^2 or W
division (/)	None, Ω (Resistance unit Ohms), S (conductance unit Siemens)
FFT	dBVrms, Vrms, dBm, dBArms, Arms
differential (d/dt)	V/s (Volt/second) or A/s (A/second)
integral ($\int dt$)	VS or AS (V * second or A * second)
square root ($\sqrt{\quad}$)	$V^{1/2}$ or $A^{1/2}$
y	V, A
Sign	V, A
Exp/Exp10	V, A
Ln/lg	V, A
intrap	V, A

Table 13.1 Math Operations Units

13.2 Arithmetic

The 2560B series can perform arithmetic operations including addition, subtraction, multiplication or division on any two analog input channels. The values of Source A and Source B are computed point by point.

13.2.1 Subtraction Example

Math operators perform arithmetic operations add or subtract operation on any two analog input channels. When you select addition or subtraction, the **Source A** and **Source B** values are added or subtracted point by point, and the result is displayed.

- In the **Function** window touch the **Source A**.
 - The **Source Setting** window shown in figure ?? will be displayed.
- Select the desired source.
 - The **Source Setting** window will close when the source is selected.
- In the **Function** window touch the **Source B**.
 - The **Source Setting** window shown in figure ?? will be displayed.
- Select the desired source.
 - The **Source Setting** window will close when the source is selected.
- Touch the operation to be performed in the **Function** window. The resulting math waveform is displayed in white and labeled with "M".



Figure 13.3 CH 1 - CH 2

13.2.2 Average

The oscilloscope accumulates multiple waveform frames and calculates the average as the result. If a stable trigger is available, the resulting average has a random noise component lower than that of a single-shot record. The more frames that are accumulated, the lower the noise is.



Figure 13.4 Average Example

Note:

Average acquisition is only valid for periodic signals, and it is important to ensure that the waveform is triggering in a stable way when using average mode.

13.2.3 ERES

The oscilloscope filters the sample, which rejects noise in the high frequency domain, so the signal-to-noise ratio (SNR) is improved. As a result, the effective number of bits (ENOB) of the oscilloscope is enhanced.



Figure 13.5 ERES Example

ERES operation does not require the signal to be periodic, nor does it require stable triggering, but due to the digital filtering, the system bandwidth of the oscilloscope will degrade when acquiring data in ERES mode. The higher the enhanced bits, the lower the bandwidth. The following table shows the relationship between ERES bits and bandwidth:

ERES Bits	-3dB bandwidth
0.5	0.25*Sample rate
1	0.115*Sample rate
1.5	0.055*Sample rate
2	0.028*Sample rate
2.5	0.014*Sample rate
3	0.007*Sample rate

Table 13.2 ERES Bits and Bandwidth

13.3 Algebra

The oscilloscope supports math function operation including differential (d/dt), integral ($\int dt$) and square root ($\sqrt{\quad}$).

13.3.1 Differentiate

$$di = \frac{y(i + dx) - y(i)}{dx}$$

d/dt (differentiate) calculates the discrete time derivative of the selected source. Where:

- d = differential waveform
- y = values of source data
- i = data point index
- dx= differential interval

The range of **dx** in the d/dt menu is 4~256.

Use differentiate to measure the instantaneous slope of a waveform. For example, the slew rate of an operational amplifier may be measured using the differentiate function.



Figure 13.6 Difference Function Operation

You can use differentiate to measure the instantaneous slope of a waveform. For example, the slew rate of an operational amplifier may be measured using the differentiate function.

Note:

Because differentiation is very sensitive to noise, it is helpful to set acquisition mode to Average.

13.3.2 Integrate

The MATH operation dt (integration) calculates the numerical integral of the selected source. ($\int dt$) calculates the integral of the waveform's data using the trapezoidal rule. The equation is:

$$I_n = c_0 + \Delta t + \sum_{i=0}^n y_i$$

Where:

- I = integrated waveform
- Δt = point- to- point time difference
- y = channel 1, 2, 3, or 4 data points
- c_0 = arbitrary constant
- i = data point index

The integrate operator provides an **Offset** softkey that lets you enter a DC offset correction factor for the input signal. Small DC offset in the integrate function input (or even small oscilloscope calibration errors) can cause the integrate function output to **ramp** up or down. This DC offset correction lets you level the integrate waveform.



Figure 13.7 Integral Operation

In addition, the integral operation can be performed within a specified gate. Touch **Gate** area in the math menu, and enable gate function, then set Gate A and Gate B to define the gate. The setting of the gate cursors is similar to that of normal cursors. See Select and Move Cursors for details.

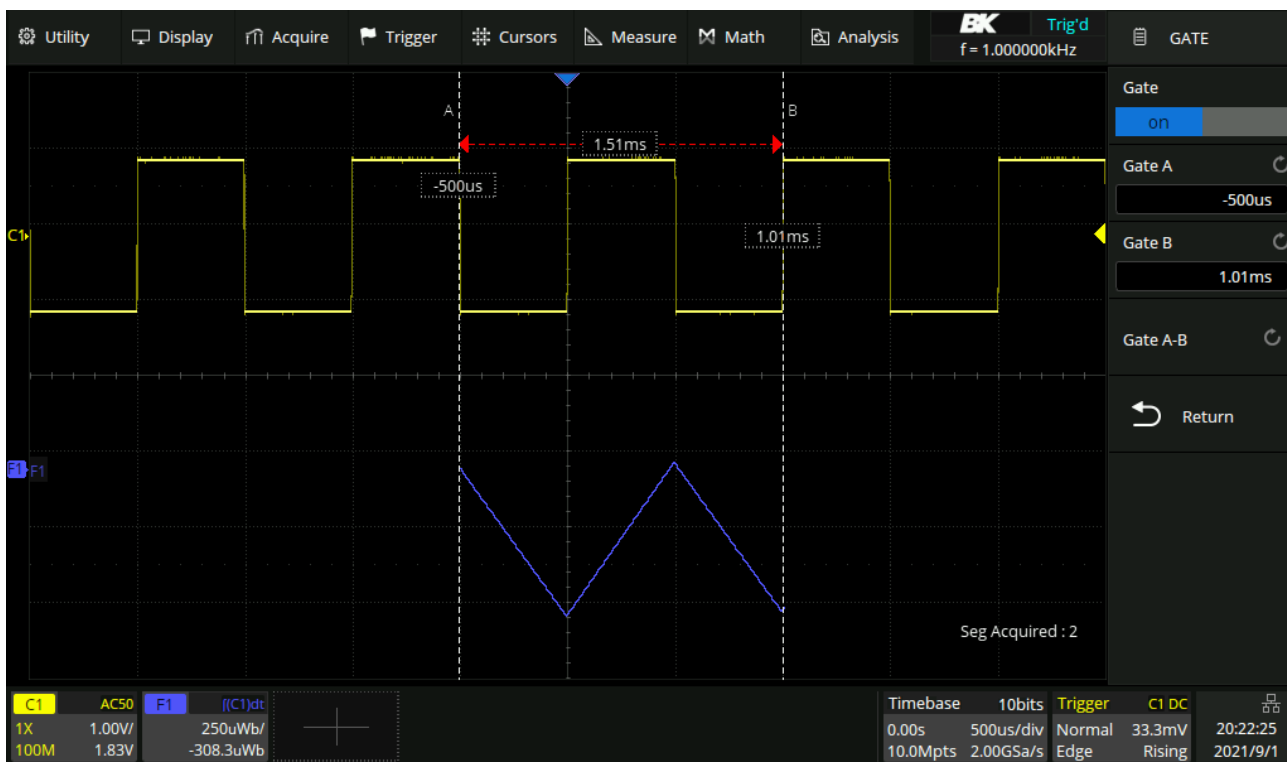

Figure 13.8 Integral Gate

13.3.3 Square Root

Square root ($\sqrt{\quad}$) calculates the square root of the selected source. Where the transform is undefined for a particular input, holes (zero values) appear in the function output.



Figure 13.9 Square Root

13.3.4 Absolute

Absolute $|y|$ calculates the absolute value of the selected trace.

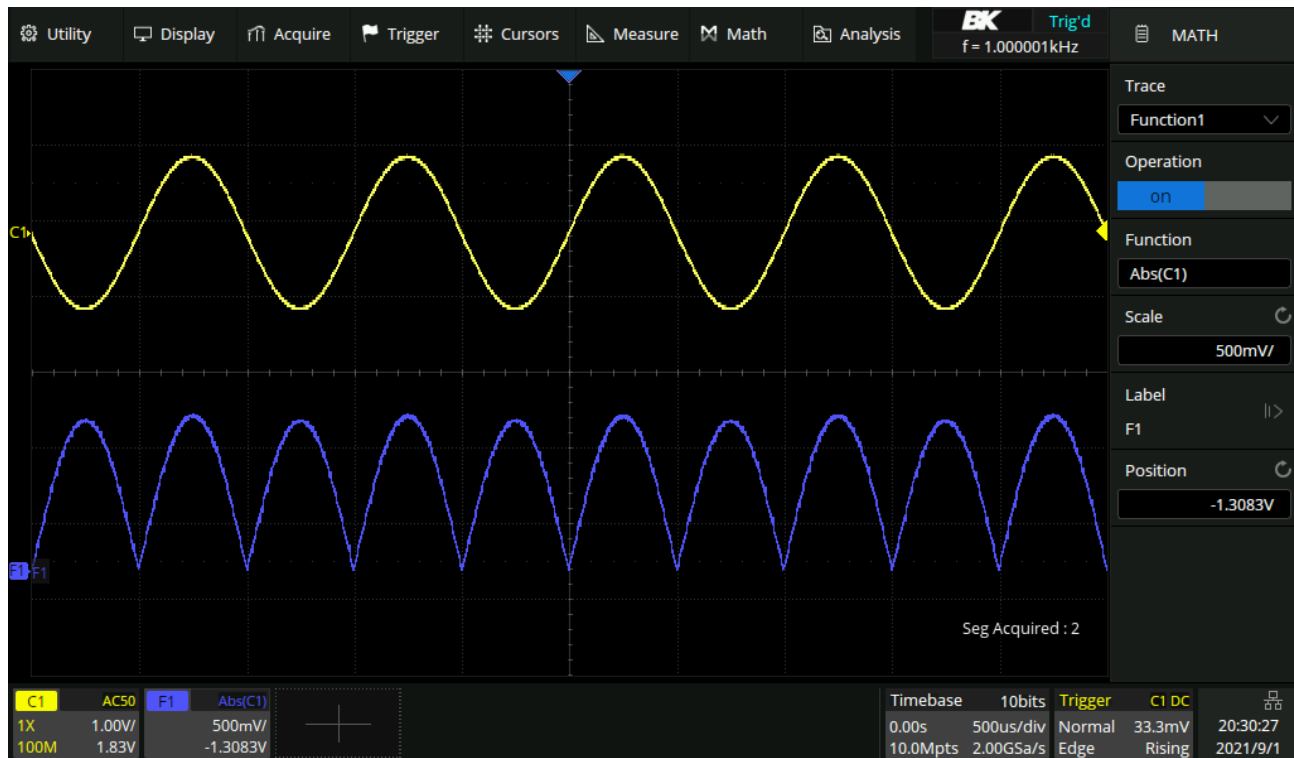

Figure 13.10 Absolute Operation

13.3.5 Sign

In mathematics, the sign function or signum function (from signum, Latin for "sign") is an odd mathematical function that extracts the sign of a real number.

The sign function of a real number x is defined as follows:

$$\begin{aligned} \text{Sign}(x) &= -1 \text{ if } x < 0, \\ &= 0 \text{ if } x = 0, \\ &= 1 \text{ if } x > 0. \end{aligned}$$

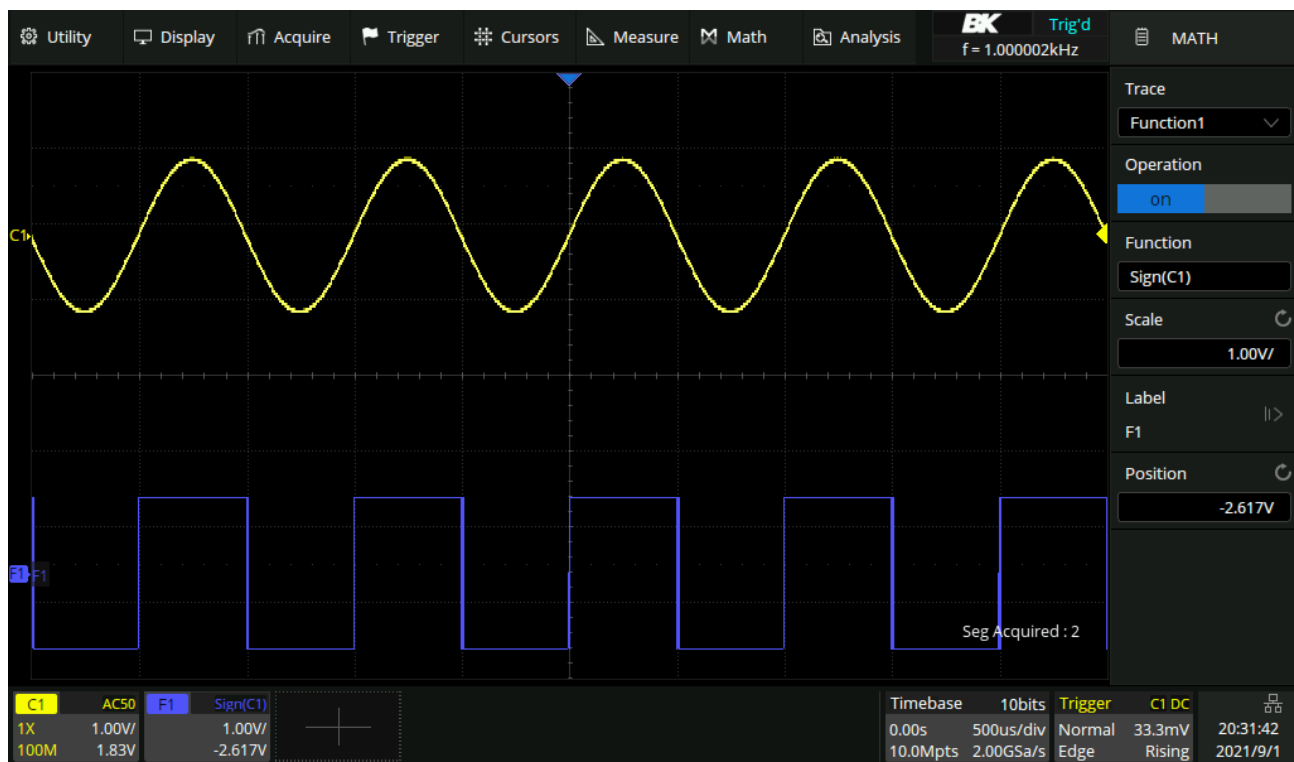

Figure 13.11 Sign Operation

13.3.6 Exp/Exp10

The exponential operation includes the exponential operation e^x based on constant e and the exponential operation 10 based on 10.



Figure 13.12 Exp Operation

13.3.7 Ln/Lg

Logarithmic operation includes logarithm base e (ln) and logarithm base 10 (lg). In logarithmic operation, if the waveform value is negative (the waveform is below the ground level), the result is displayed as zero.

For example: $F1 = e^x$, where x is the trigonometric wave function. $F2 = \lg(F1)$.



Figure 13.13 Ln/Lg Operation

13.3.8 Interpolate

Between the adjacent sampling points, the waveform is interpolated according to the selected interpolation method and interpolation coefficient. Touch **Acquire Interpolation** to set the interpolation method, and the interpolation coefficient can be set to 2, 5, 10 or 20.

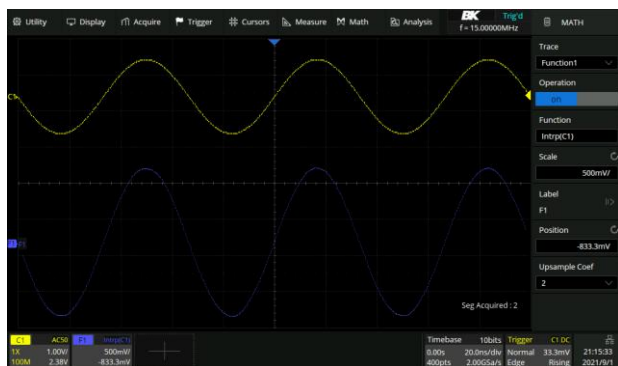

Coefficient = 2

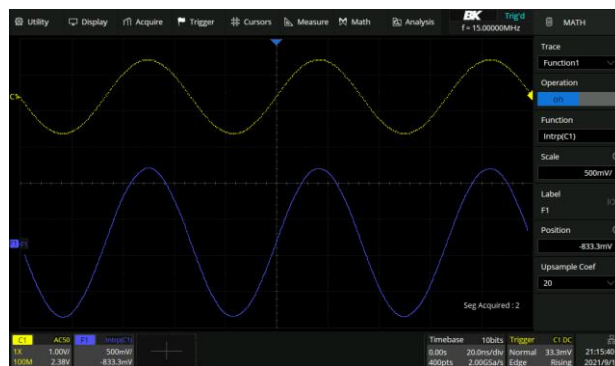

Coefficient = 20

Figure 13.14

13.4 Frequency Analysis (FFT Operation)

FFT is used to compute the fast Fourier transform using analog input channels. FFT takes the digitized time record of the specified source and transforms it to the frequency domain. When the FFT function is selected, the FFT spectrum is plotted on the oscilloscope display as magnitude in dBV versus frequency. The readout for the horizontal axis changes from time to frequency (Hertz) and the vertical readout changes from V to dB.

FFT operation can facilitate the following works:

- Measure harmonic components and distortion in the device under test
- Measure the characteristics of the noise in DC power
- Analyze vibration

13.4.1 Setting FFT Parameters

1. Touch the **Config** option to enter config menu.
2. Press the **Maximum points**, and then select the maximum points (1 K to 2 M).
3. Touch the **Window** option, and then turn the **Universal Knob** to select an appropriate window.
Spectral leakage can be considerably decreased when a window function is used. The oscilloscope provides five windows (Rectangle, Blackman, Hanning, Hamming and Flatop) which have different characteristics and are applicable to measure different waveforms. Select the window function according to different waveforms and their characteristics. Refer to table 13.3 to make an appropriate option according to the input signal.
4. Touch **Full Span** to view the full span of the frequency analysis or touch **Peak to Center** to center the peak in the analysis.
5. Touch **Display** to view the available options.
 - **Split**: Time-domain waveform and frequency domain waveform are displayed separately. The time-domain waveform is on the upper half screen, while the frequency domain waveform is located within the lower half of the display. In Split mode, if Zoom is enabled, the zoomed waveform and the frequency domain waveform are displayed on the lower half screen together. (See figure ??)
 - **Full Screen**: Time-domain waveform and frequency-domain waveform are displayed together. (See figure ??)
 - **Exclusive**: Only the frequency-domain waveform is displayed. (See figure ??)
6. Touch **FFT Mode** to view the available options.
 - **Normal**: Displays the FFT result of each frame directly.
 - **Max-Hold**: Holds the maximum value in the historic frame on the display until cleared. This mode is suitable for detecting discontinuous waves, such as sporadic pulse signals, or frequency hopping signals.
 - **Average**: Reduces the effect of the superimposed random noise on the signal. After the FFT mode is set as Average, Average will appear under FFT Mode. The average count can be set here, ranging from 4 to 1024.

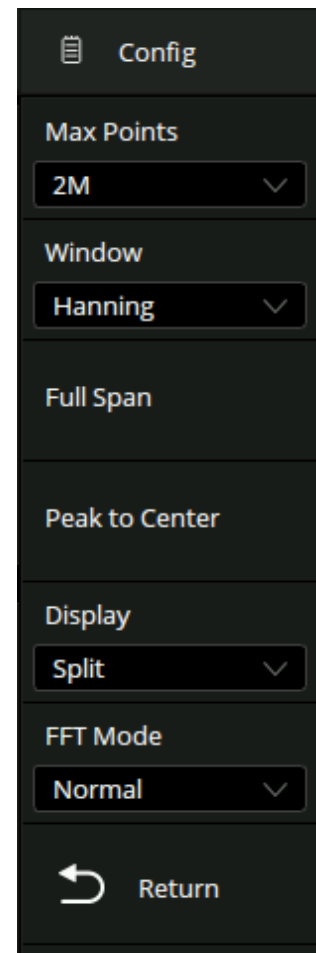
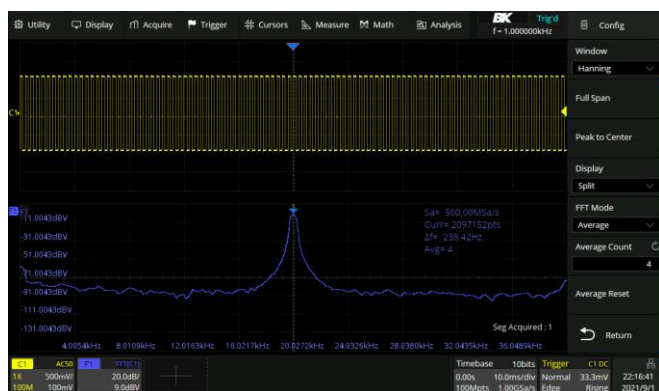

Figure 13.15 Config Menu

Window	Applications and Characteristics
Rectangle	These are normally used when the signal is transient (completely contained in the time-domain window) or known to have a fundamental frequency component that is an integer multiple of the fundamental frequency of the window. Signals other than these types will show varying amounts of spectral leakage and scallop loss, which can be corrected by selecting another type of window.
Hanning	These reduce leakage and improve amplitude accuracy. However, frequency resolution is also reduced.
Hamming	These reduce leakage and improve amplitude accuracy. However, frequency resolution is also reduced.
Flat Top	This window provides excellent amplitude accuracy with moderate reduction of leakage, but with reduced frequency resolution.
Blackman	It reduces the leakage to a minimum, but with reduced frequency resolution.

Table 13.3 FFT Window



Split Mode, Zoom off

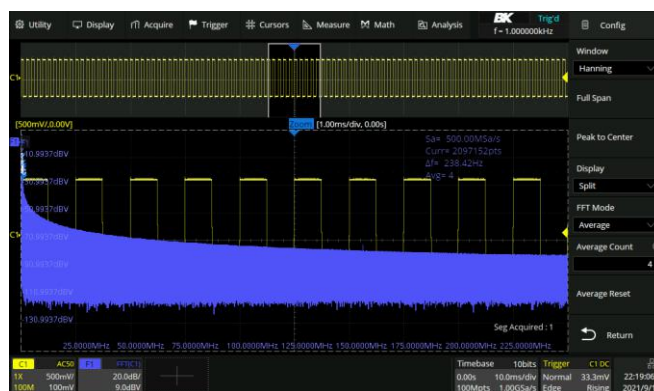

Split Mode, Zoom on

Figure 13.16 Split Mode Display

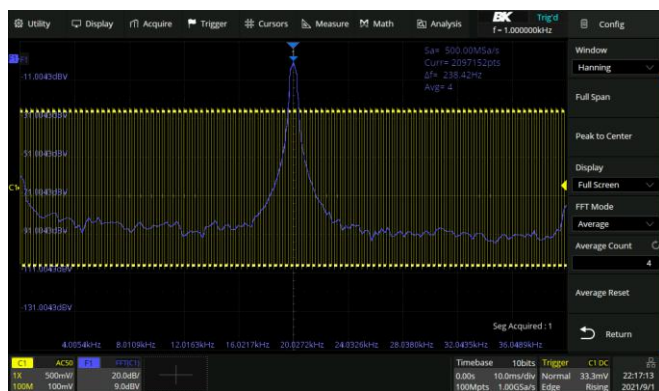

Full Screen Mode

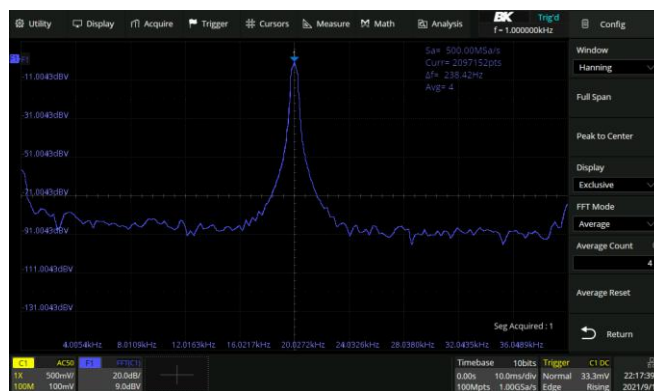

Exclusive Mode

Figure 13.17 Full and Exclusive Mode Display

13.4.2 Parameter Display Area

The FFT parameters are displayed in the upper right of the spectrum waveform display area:

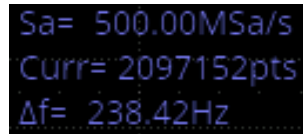

Sa= 500.00MSa/s
Curr= 2097152pts
Δf= 238.42Hz

Figure 13.18
Parameter Display Area

- **FFT sample rate (Sa):** FFT operation results present the first Nyquist zone (DC Sa/2) of the frequency spectrum. Be aware that the FFT sample rate may be inconsistent with the sample rate in the time domain. Assuming the max points is set to 2 Mpts:
 - When the number of points in the time domain, N, is less than 2 Mpts, the FFT takes the number which is an integer power of 2 closest to N. In this case, the FFT sample rate = sample rate in the time domain.
 - When N is greater than 2 Mpts, FFT first decimates N by D and then takes the first 2 Mpts for the calculation. In this case, the FFT sample rate = sample rate in time domain/D.

For example, in the case of sample rate in the time domain is 1 GSa/s and the number of samples is 10 Mpts, the FFT first decimates the samples by 4, to 2.5 Mpts, and then takes the first 2 Mpts to calculate the spectrum. In this example, FFT sample rate = 1 GSa/s ÷ 4 = 250 MSa/s.
- **FFT points (Curr):** The current FFT points, which is an integer power of 2, up to 2 M points (2097152, to be exact).
- **Frequency interval (f):** The frequency interval between two adjacent points in the FFT sequence, which is proportional to the frequency resolution.
- **Average count of FFT (Avg):** Displayed only when the FFT mode is set to "Average", indicating the completed average count.

13.4.3 Vertical

Touch **Vertical** in the math menu to recall the FFT vertical menu:

- Touch **Scale** to set the vertical scale of FFT waveform by the universal knob or the virtual keypad.
 - It can also be set by the scale knob shared by Decode, Digital, Math, and Ref on the front panel.
 - The reference point for vertical scale scaling is the reference level.
- Touch **Ref Level** to set the reference level of FFT waveform by the universal knob or the virtual keypad.
 - It can also be set by the offset knob shared by Decode, Digital, Math, and Ref on the front panel.
- Set the unit (dBVrms, Vrms and dBm). When the unit is dBm, the oscilloscope will automatically calculate the dBm value based on the Ext Loadvalue set in area.

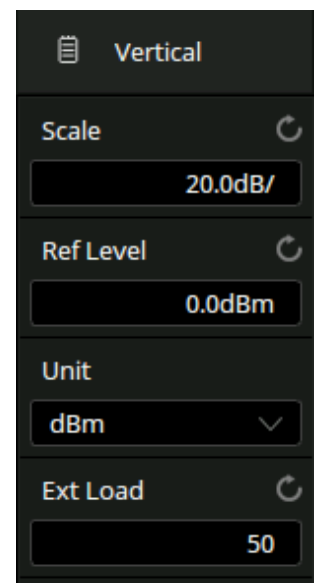

Figure 13.19 Vertical Menu

13.4.4 Horizontal

Touch **Horizontal** in the math menu to recall the FFT horizontal menu:

- Touch **Center** to set the center frequency by the **universal knob** or the virtual keypad.
- Touch **Span** to set the frequency span by the **universal knob** or the virtual keypad.
- Touch **Start** to set the start frequency by the **universal knob** or the virtual keypad.
- Touch **End** to set the end frequency by the **universal knob** or the virtual keypad.

The relationship between Center, Span, Start and End is:

$$\text{Center} = (\text{Start} + \text{End})/2$$

$$\text{Span} = \text{End} - \text{Start}$$

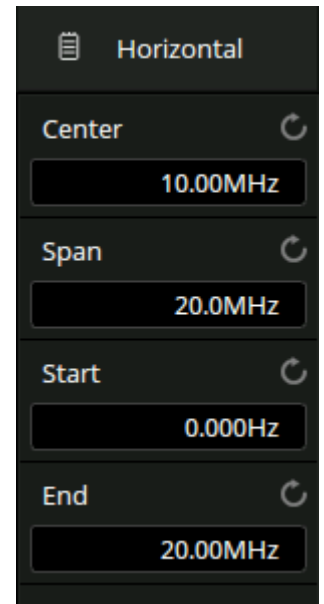

Figure 13.20 Horizontal Menu

13.5 FFT Tools

The peaks tool can automatically search up to 10 qualified peak points and mark them on the FFT waveform.

13.5.1 Peaks Tool

To configure the **Peaks** tool:

1. Press the **Math** to open the math menu.
2. Touch the **Tools** option.
3. Touch **Type** and select **Peaks**. The menu shown in figure 13.21 will be displayed.
4. Toggle the **Peak** table on and off by touching **Show Table**.
5. Toggle the **Frequency** column on and off by touching **Show Frequency**.
 - **Show Table** must be enabled to display the frequency column.
6. Touch **Sort By** to toggle between sorting by **Amplitude** or **Frequency**.
7. Touch **Search Threshold** to set the search threshold.
 - Only peaks larger than the limit is shown
8. Touch **Search Excursion** to set the difference between the peak value and the minimum amplitude on both sides.
 - The difference should be greater than the search excursion.

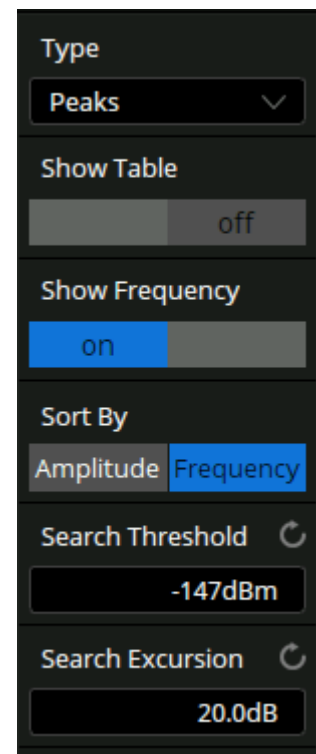

Figure 13.21 Peaks Menu

13.5.2 Markers Tool

Based on the peak tool, the markers tool can automatically search the qualified harmonics, and users can control the position of each marker. Up to 8 markers are supported.

To configure the **Markers** tool:

1. Press the **Math** to open the math menu.
2. Touch the **Tools** option.
3. Touch **Type** and select **Markers**. The menu shown in figure 13.22 will be displayed.
4. Touch the **Marker Control** to control the display and position of each marker.
5. Touch **Marker on Peaks** to automatically mark the peak that meets the conditions of **Search Threshold** and **Search Excursion**.
6. Touch **Marker on Harmonics** to automatically mark each harmonic of the FFT waveform.
7. Touch **Show Table** to toggle the table on or off.
8. Touch **Show Frequency** to toggle the frequency column on or off.
9. Touch **Show Delta** to toggle the delta display on or off
10. Touch **Search Threshold** to set the search threshold.
 - Only peaks larger than the peak limit can be judged as peaks
11. Touch **Search Excursion** to set the difference between the peak value and the minimum amplitude on both sides.
 - The difference should be greater than the search excursion, which can be determined as the peak

Note:

The markers menu is longer than the display. Slide the dialog box area up and down by gestures, or scroll the mouse wheel to the view non-displayed areas.

Figure 13.24 shows the peak tool enabled.

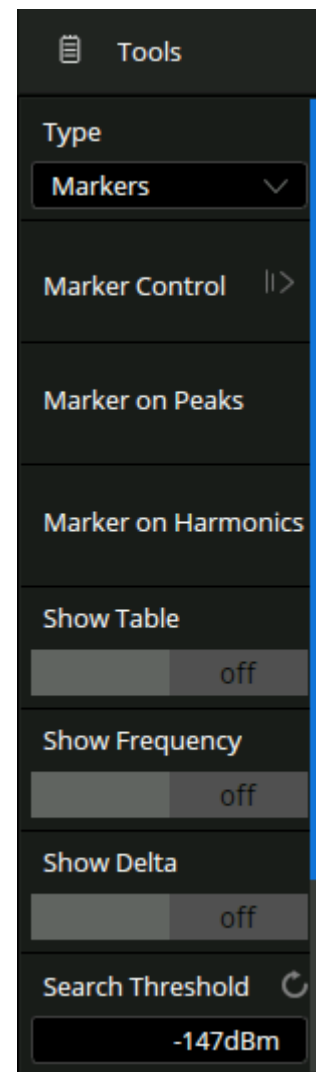

Figure 13.22 Markers Menu

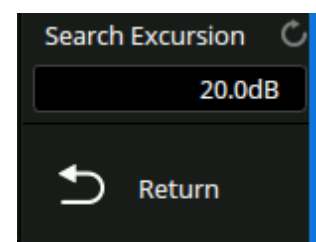

Figure 13.23 Markers Menu Continued

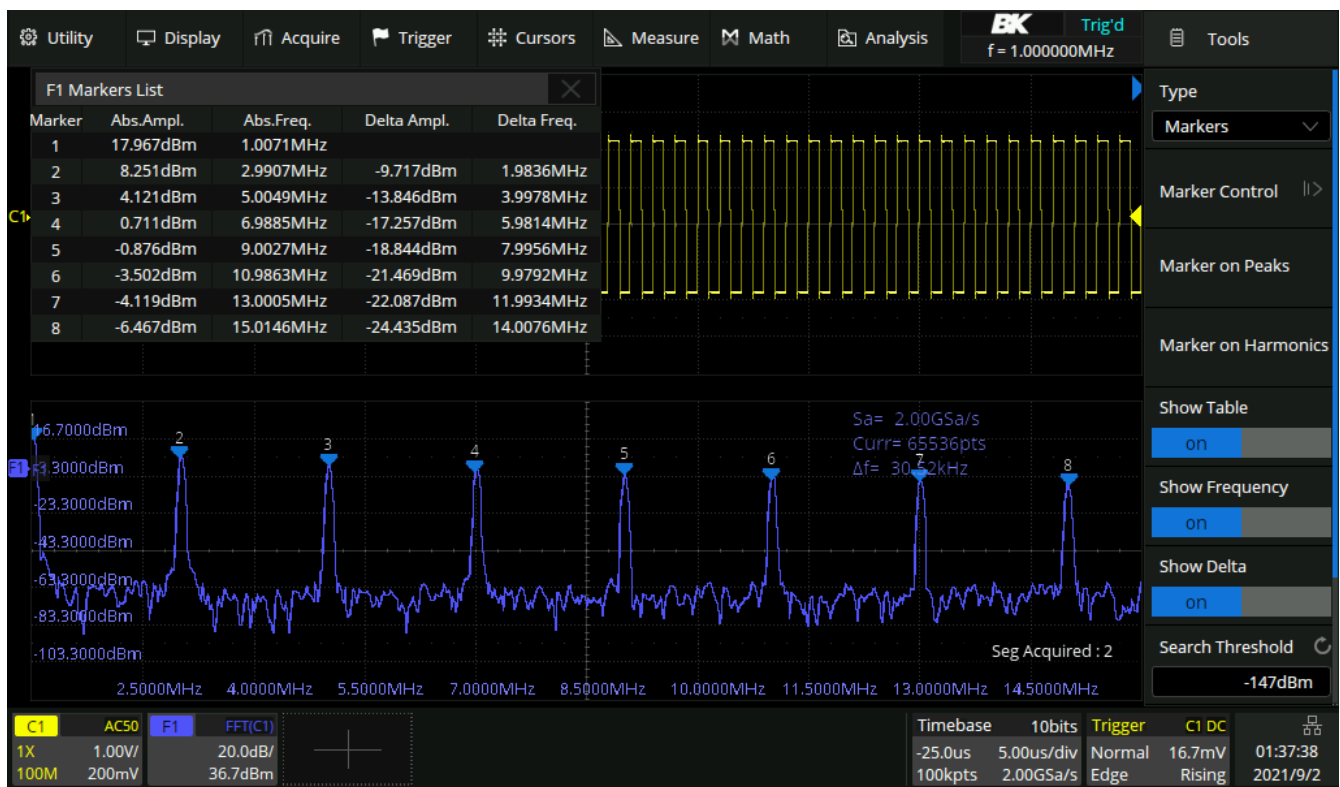

Figure 13.24 Marker Tool

13.5.3 Measure the FFT Waveform

Press the **Cursors** button on the front panel to turn on the cursor function. Specify the source as **Math**. X1 and X2 cursors can be used to measure the frequency value at the cursor position. Only the maximum parameter of the FFT is supported in automatic measurement.

Note:

DC components in the signal may show a large amplitude near 0 Hz. If your application does not require measurement of the DC component, it is recommended to set the coupling mode of the source channel to **AC**.

13.6 Formula Editor

Custom formulas can be created using the **Formula Editor**.

To open the **Formula Editor**:

1. Press the **Math** to open the math menu.
2. Touch **Functions** to open the Function Window.
3. Touch the **Formula Editor** tab.
 - The **Formula Editor** tab shown in figure 13.25 will be displayed.

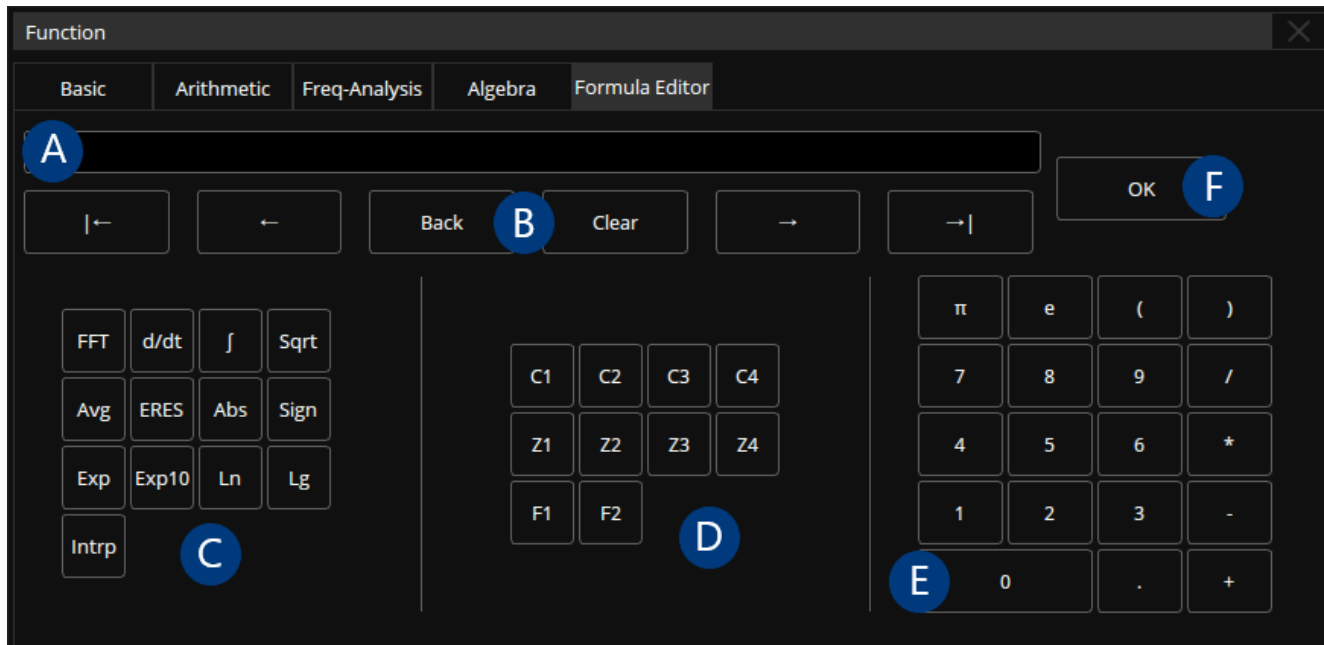

Figure 13.25 Formula Editor

- A. Formula display text box
- B. Text box operation area, which can clear and modify the entered formula
- C. Special operators
- D. Operation source. Cx represents analog traces, Zx represents zoomed traces and Fx represents math traces
- E. Keyboard area, which contains the basic arithmetic operators of addition (+), subtraction (-), multiplication (*), division (/)
- F. Confirm button. After the formula is input, press the button to apply it

Reference Waveform

Data from analog channels or math can be saved to the reference locations (REFA/REFB/REFC/REFD) in the built-in non-volatile memory. The saved reference waveform can be recalled to be compared with the current waveform.

14.1 Save REF Waveform to Internal Memory

To save the REF waveform to internal memory:

1. Press the REF button on the front to enter the REF WAVE function menu or touch  in the descriptor box region and select Ref to recall the ref dialog box

Note:

When the time horizontal format is in X-Y mode, REF function cannot be enabled.

2. Touch **Location**; then select the location in which to save the REF waveform.
3. Touch **Source**; then, select the source of reference channel. The source includes analog channel and math waveforms.
4. Touch the **Save** icon to save the channel or math waveform to the appointed location.
 - The vertical scale information and the vertical offset of the waveform will be saved at the same time.
 - It will pop out the message "Save to internal file REF" when the waveform has been saved successfully.

Note:

REF waveforms are non-volatile. The REF waveform can still be recalled after restarts or default operation.

14.2 Display REF Waveforms

To display a REF waveform:

1. Press the REF button on the front to enter the REF WAVE function menu or touch  in the descriptor box region and select Ref to recall the ref dialog box
2. Touch **Location**; then select the location of the waveform to be recalled.
3. Touch **Display** to toggle the waveform on or off. (See figure 14.1)

Note:

Set the vertical position of the reference waveform by the offset knob shared by Decode, Digital, Math, and Ref on the front panel, and set the vertical scale of the reference waveform by the scale knob.



Figure 14.1 Recall REFB

Search

The 2560B can search for the specified events in a frame. The location of the qualifying events are displayed with a white triangle symbol. In the YT mode or the Roll mode with the acquisition in stop, the maximum search events number is 1000. In the Roll mode with acquisition in run, the maximum search events number is unlimited. The waveform can be zoomed when search function is enabled.

15.1 Setting

1. Press the **Search** key on the front panel.
2. Touch **Setup Menu** to enter the search menu.
3. Press **Mode** and then select the desired search type.
 - Five search types are available: Edge, Slope, Pulse, Interval, Runt. For more details see table **15.1**

Search Mode	Setting Menu Description
Edge	Slope includes Rising, Falling, Either.
Slope	Slope includes Rising, Falling Limit Range includes four types: \leq , \geq , $[-,-]$ and $-[-$, Users can select the desired type and then input the time value.
Pulse	Polarity includes Positive and Negative Limit Range includes four types: \leq , \geq , $[-,-]$ and $-[-$, Users can select the desired type and then input the time value.
Interval	Slope includes Rising, Falling Limit Range includes four types: \leq , \geq , $[-,-]$ and $-[-$, Users can select the desired type and then input the time value.
Runt	Polarity includes Positive and Negative Limit Range includes four types: \leq , \geq , $[-,-]$ and $-[-$, Users can select the desired type and then input the time value

Table 15.1 Search Modes

Note:

Search setup is similar to the corresponding trigger type. See the sections **Edge Trigger**, **Slope Trigger**, **Pulse Trigger**, **Interval Trigger** and **Runt Trigger** for details.

15.2 Copy

The 2560B series supports replication between search settings and trigger settings.

- Copy from Trigger: Synchronize the current trigger settings to the search settings.
- Copy to Trigger: Synchronize the current search settings to the trigger settings.
- Cancel Copy: Cancel the last synchronization and restore the settings before it.

Note:

When performing a copy from trigger, if the trigger type is not supported by search, the operation is invalid.

15.3 Results

When the acquisition is started, "**EVENT NUM: 9**" means total events number.

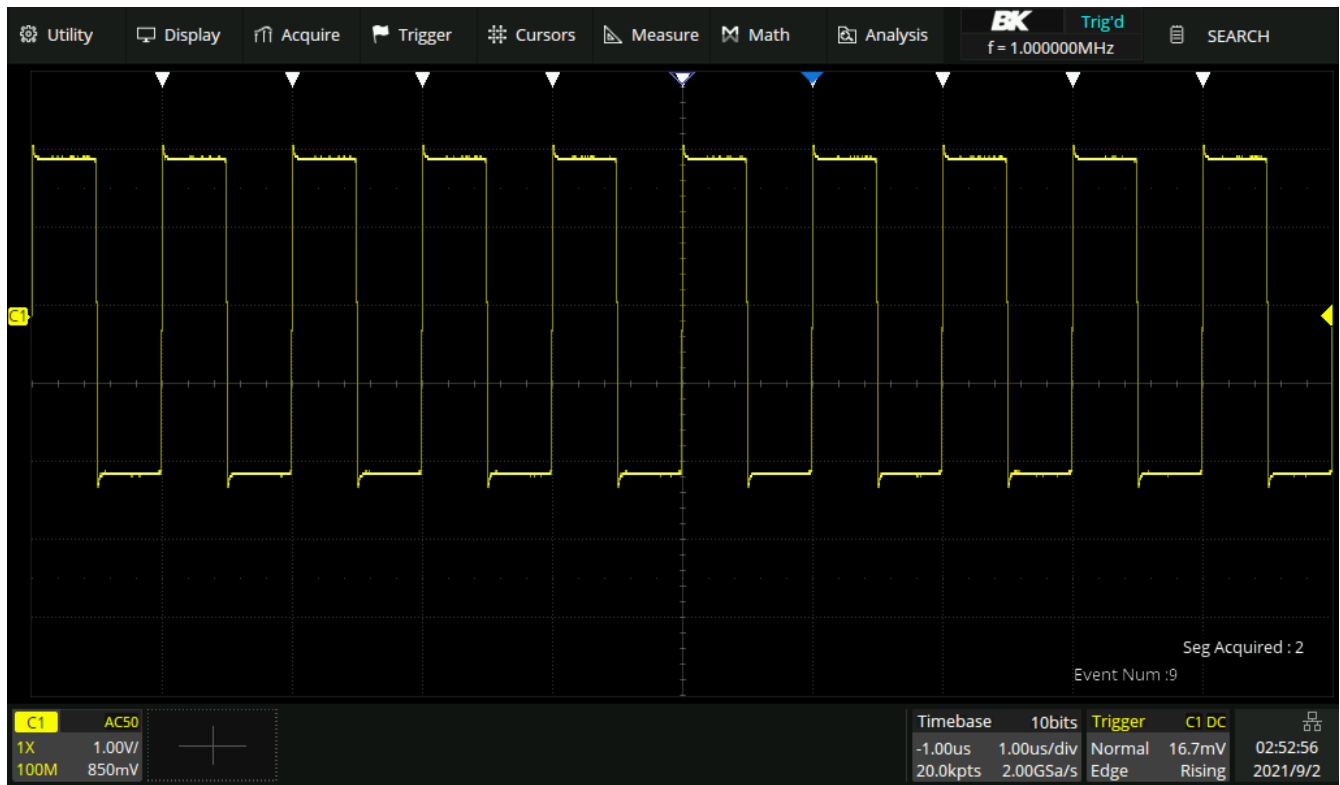





Figure 15.1 Search in Run

When the acquisition is stop, "EVENT NUM: 4/7" means current event number/total events number, the current event is the closest event to the middle of the screen.

Navigate

The 2194 provides three navigate types: Search Event, Time , History Frame.

16.1 Navigate by Time

1. Press the **Navigate** key on the front panel or touch the menu **Analysis > Navigate** to enter the Navigate function menu.
2. Touch **Type** in the **Navigate** menu, to select the navigate type as **Time**.
 - There are two ways to navigate by time:
 - Touch the **Time** area to set the time value by the universal knob or the virtual keypad.
 - Touch the navigation options  in the **Navigate** menu to play backward, stop, or play forward the waveform. Touch  or  multiple times to speed up the playing. Three speed levels are supported: Low Speed, Medium Speed and High Speed.

Note:

The oscilloscope automatically adjusts the trigger delay according to the direction set by the user.



Figure 16.1 High Speed

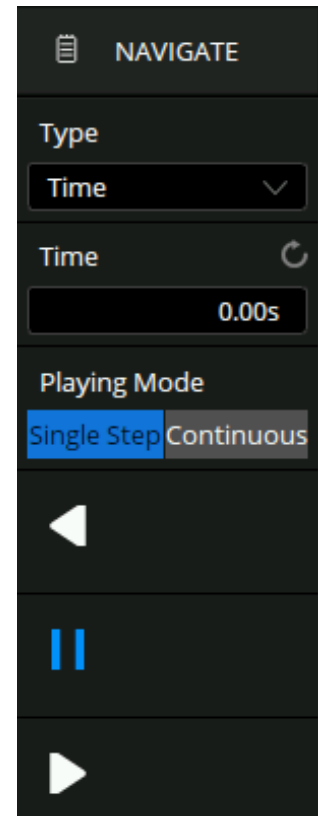

Figure 16.2 Navigate by Time

16.2 Navigate by Search Event

When the Search function is turned on and the acquisition is stopped, Navigate is usable to find search events (see the chapter [Search](#) for search function).

1. Press the **Navigate** key on the front panel or touch the menu **Analysis > Navigate** to enter the Navigate function menu.
2. Touch **Type** in the **Navigate** menu, to select the navigate type as **Search Event**.
3. Touch **Event Num** to set the event number by the universal knob or the virtual keypad.
 - Touch the navigation option ◀ or ▶ to go to the previous or next search event.
4. Touch the **Event List Switch** area to turn on or off the list. The list contains time labels for each event. Touching a row in the list automatically jumps to the corresponding event. This operation is equivalent to specifying an event in the **Event Num** area.

Note:

The **Event List** can be moved by using the touch and drag gesture.

5. Touch **Interval Time** to set the playing interval by the universal knob or the virtual keypad.



Figure 16.3 Navigate by Event

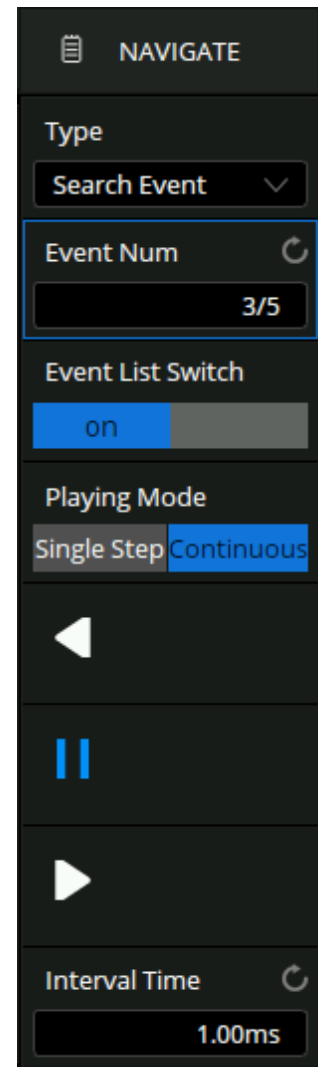

Figure 16.4 Navigate by Event

16.3 Navigate by History Frame

When the history function is enabled, Navigate can be used to play history frames (see the chapter "[History](#)" for details of history function).

1. Press the **Navigate** key on the front panel or touch the menu **Analysis > Navigate** to enter the Navigate function menu.
2. Touch **Type** in the **Navigate** menu, to select the navigate type as **History Frame**.
3. Touch **Frame** to set the frame number by the universal knob or the virtual keypad.
 - Touch the navigation options  on to play backward, stop, or play forward.
4. Touch **Playing Mode** to set the search event playing mode.
5. Touch **Interval Time** to set the playing interval by the universal knob or the virtual keypad.
6. Touch **Stop On Search Event** to set the stop play condition: stop when the event is searched. This setting is only valid when the search function is on



Figure 16.5 Navigate by History Frame

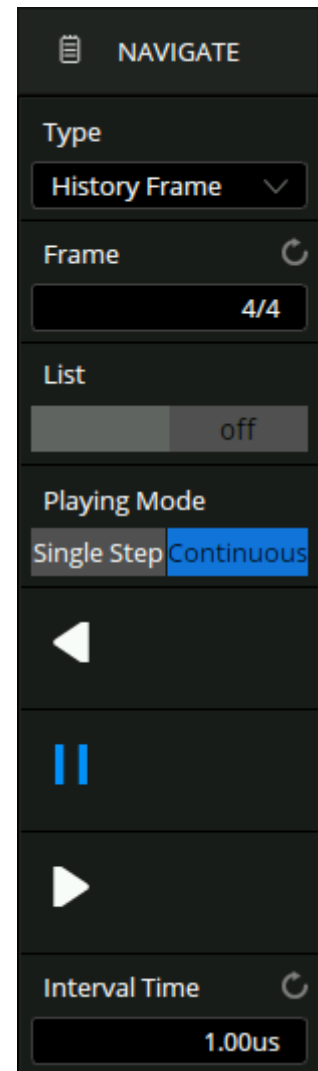

Figure 16.6 Navigate by History Frame Menu

Mask Test

To verify if a waveform is within desired bounds use pass/fail testing. A pass/fail test defines a region of the oscilloscope display (mask) in which the waveform must remain in order to pass the test. Being within a specified-range is verified point-by-point across the display.

The test results can be displayed on the screen as well as be declared through the system sound or a pulse output from the Aux Out connector on the rear panel. The Pass/Fail test only operates on analog channels that are displayed.

This is very useful to find and quantify anomalies in production tests or similar batch measurements.

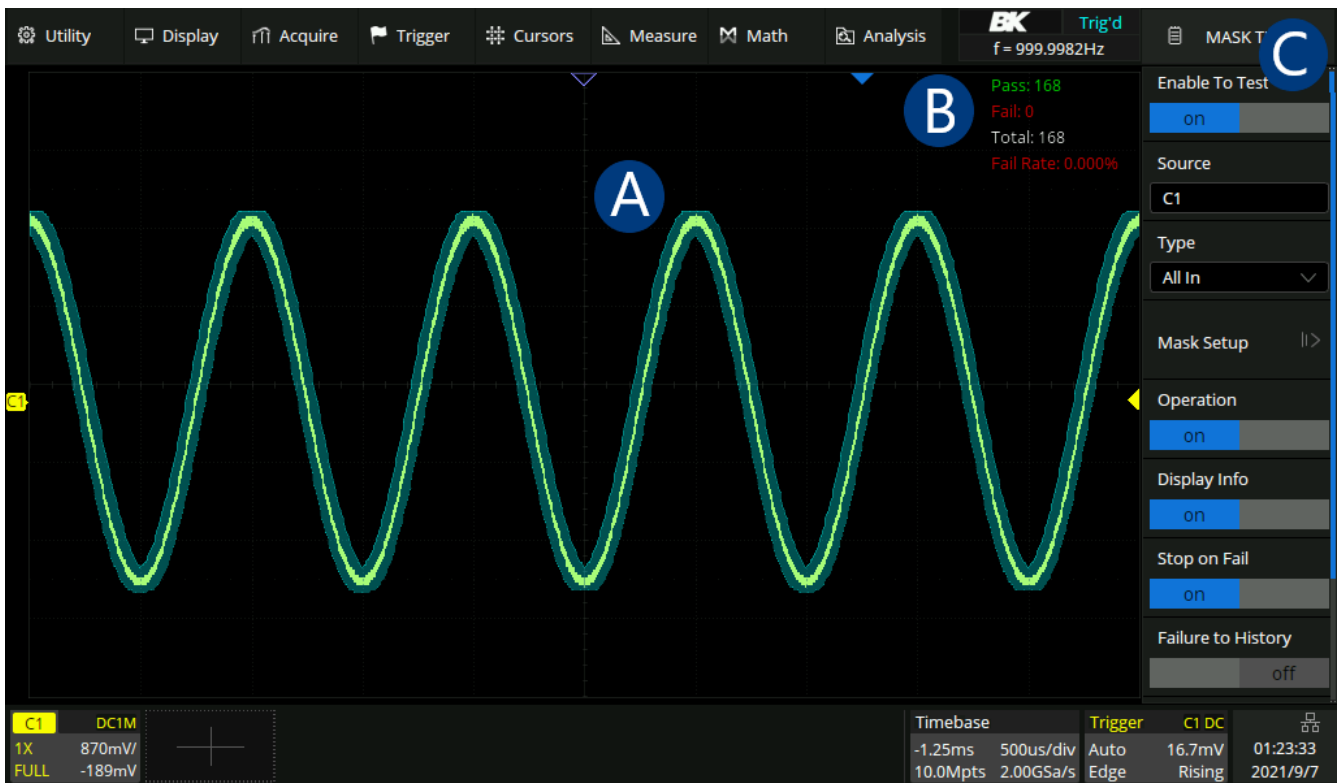

Figure 17.1 Mask Test

- A. Mask area in green. Any dot violating the rule is highlighted in red, instead of the normal waveform color.
- B. Pass/Fail display area, including the count of the passing frames, failed frames, total frames, and the fail rate.
- C. **Mask Test** menu.

17.1 Mask Setup

Touch **Mask Setup** in the **Mask Test** menu to set the mask.

There are two methods to create a mask:

- **Create Mask:** Set horizontal and vertical values .
- **Mask Editor:** Draw polygons to create a mask.
- Previously saved mask can be recalled by precession **Load** and selecting the desired file.

17.1.1 Create Mask

To create a mask based on an existing waveform:

1. Touch **Analysis > Mask Test > Mask Setup > Create Mask.**
 - The **Mask Setup** menu shown in figure 17.3 will be displayed.
2. Touch **Mask X** to set the spacing of the mask to the trace in horizontal, with the unit of division.
3. Touch **Mask Y** to set the spacing of the mask to the trace in vertical, with the unit of division.
4. Touch **Create Mask** to create the mask based on the settings of **Mask X** and **Mask Y**.
5. Touch the **Save** icon to save the mask to the specified location.
 - Saving and recalling mask files (*.msk) is similar to the operation of setup files, see section Save/Recall for more details.

Set the values for Mask X and Mask Y (in divisions of display graticule), and then perform Create Mask to generate the mask. The horizontal and vertical adjustment range is 0.08 4.00 div.

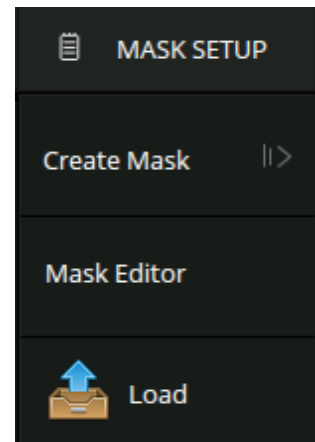

Figure 17.2 Mask Setup

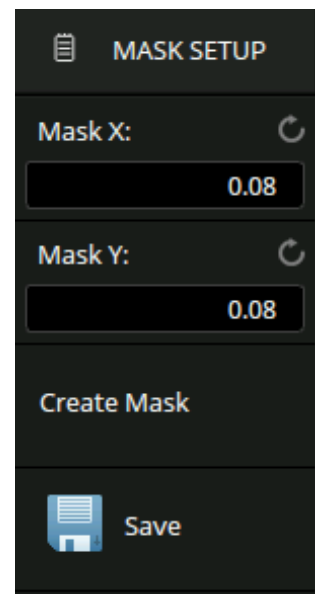
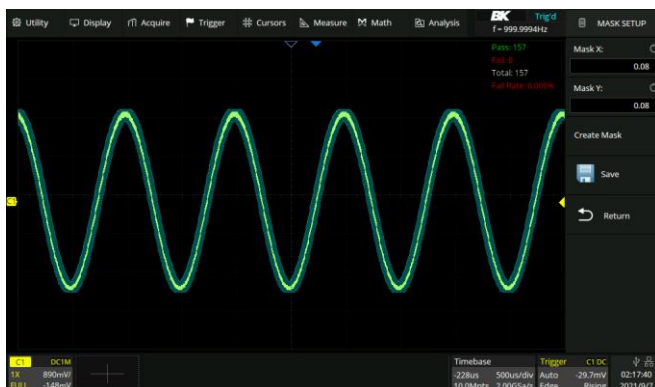
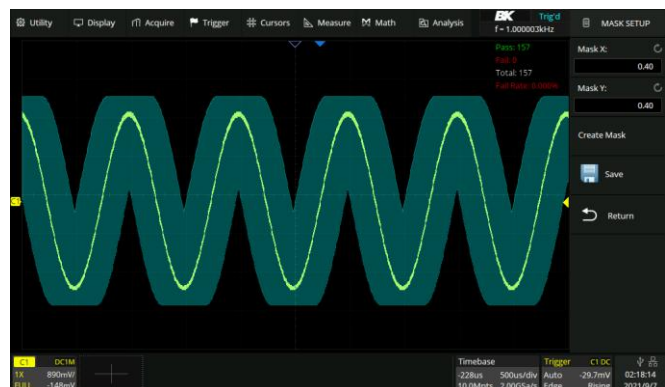

Figure 17.3 Create Mask



X = 0.08 div, Y = 0.08 div



X = 0.4 div, Y = 0.4 div

Figure 17.4 Create Mask

17.1.2 Mask Editor

The mask editor is a built-in tool that provides an approach to create custom masks. To enter the mask editor:

Touch **Analysis > Mask Test > Mask Setup > Mask Editor**.

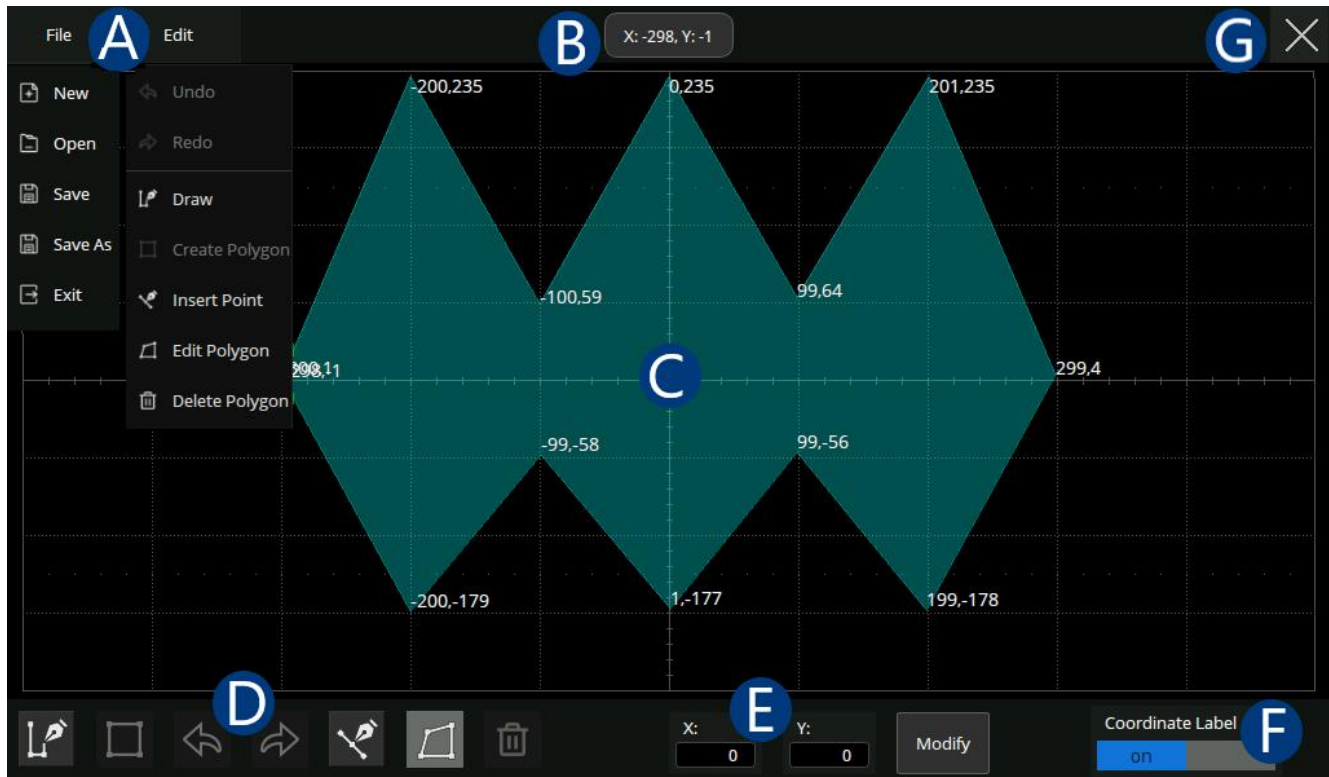



Figure 17.5 Mask Editor

A. **Menu bar:** There are 2 menus on the menu bar.

- The File menu includes ordinary file operations such as:
 - **New:** Create a new mask file
 - **Open:** Open an existed mask file
 - **Save:** Save the current mask file
 - **Exit:** Exit the Mask Editor tool
- The contents of the Edit menu are equivalent to the Toolbar.
 - **Draw:** Creates vertices of a polygon by touching the display or entering values in the coordinate edit area
 - **Create Polygon:** Creates a polygon based on the drawn vertices by the operation Draw
 - **Undo**
 - **Redo**
 - **Insert Point:** Inserts a vertex on a selected side

-  **Edit Polygon:** Edits a polygon. Vertices, sides and the polygon are all editable objects
-  **Delete Polygon:** Deletes selected polygon

B. Coordinate of the latest touched point on the display

C. Mask edit area, which is equivalent to the grid area. In this example, a hexagon has been created as a part of the mask

D. Toolbar

E. Coordinate edit area. Set the X ordinate and Y ordinate by the virtual keypad and then touch the "Input" button to perform the ordinate update

F. Display or hide coordinate of polygon vertices on the display

G. Exit the tool

To edit a vertex, side or polygon object, firstly select it, and then move it by a dragging gesture or by entering the desired value in the coordinate edit area. For a side, the value is for its middle point. For a polygon, the ordinate is for its geometric center.

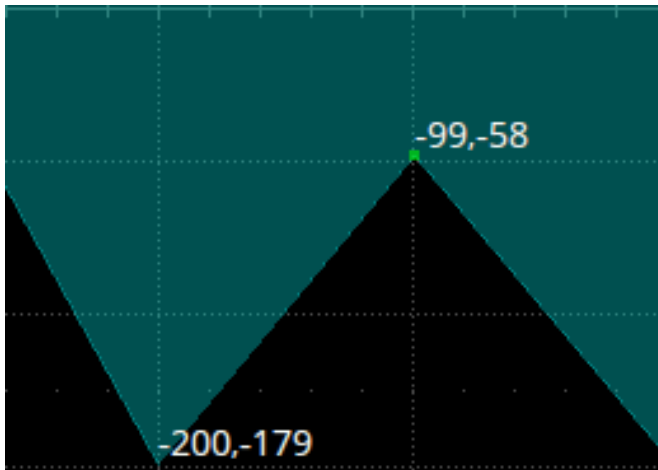

Select a vertex (point)

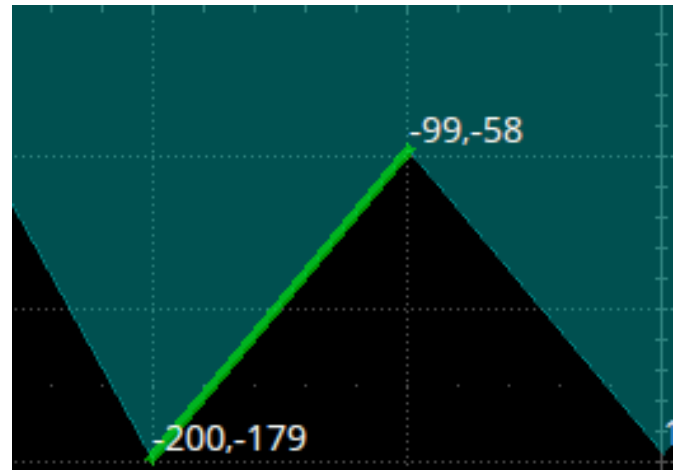

Select a side (line segment)

Figure 17.6 Edit Polygon

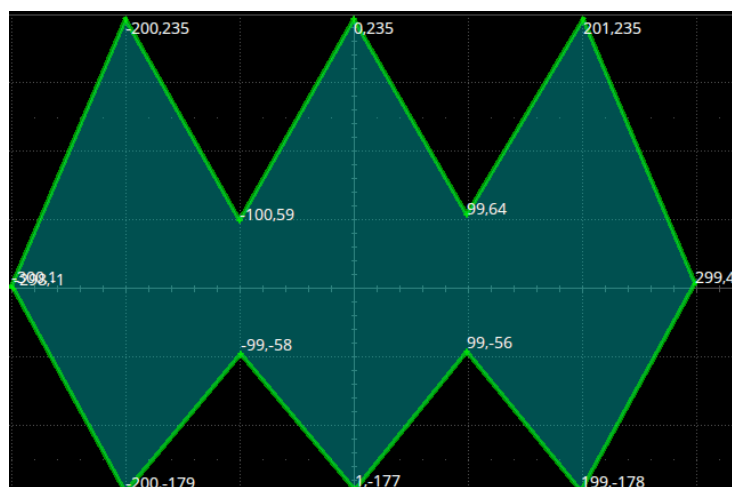

Figure 17.7 Select Polygon

17.2 Operation

Touch **Operation** to start/stop the test. Stopping a test in progress and restart the test will clear the count of the passing frames, failed frames, total frames, and the fail rate. Pressing the Clear Sweeps button on the front panel can also clear the count information.

17.3 Pass/Fail Rule

The Pass/Fail rule is specified at the Type region in the Mask Test menu.

1. Touch **Enable To Test** to enable the mask test function.
2. Touch **Type** to select the pass/fail rule.
 - **All In:** All data points must be inside the mask to pass the test. Even a single point outside the mask will cause a failure.
 - **All Out:** All data points must be outside the mask to pass the test. Even a single point inside the mask will cause a failure.
 - **Any In:** Any data point inside the mask will be recognized as a pass. All data points outside the mask will cause a failure.
 - **Any Out:** Any data point outside the mask will be recognized as a pass. All data points inside the mask will cause a failure.
3. Touch **Operation** to turn on/off the Pass/Fail operation.
 - Turning off the operation when the test is in progress will stop the test immediately, and the counters in the information display area will stop.
 - Turn on the operation again re-starts the test and all the counters are cleared.
 - Pressing the Clear Sweeps button on the front panel is equivalent.
4. Touch **Display Info** to toggle the information display.
5. Touch **Stop on Fail** to automatically end the test once the oscilloscope detects a failure.
6. Touch **Failure to History** to automatically store the failure frame in the buffer.
7. Touch **Capture on Fail** to automatically save a screenshot with the failure frame.
8. Touch **Output** to toggle the sound prompt when a failure occurs.

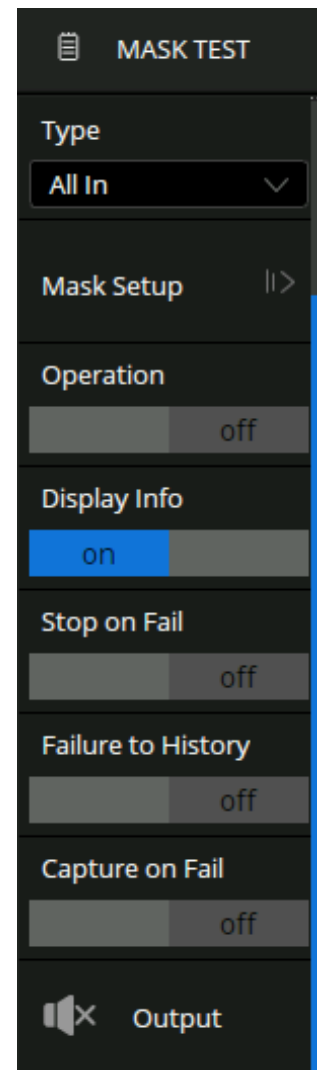

Figure 17.8 Mask Test Menu

Counter

The counter is used to measure the frequency and period of a signal or count the events happening within it. The counter is asynchronous to the acquisition system of the oscilloscope. It can work well even if the acquisition of the oscilloscope is stopped (indicated by a red-colored Run/Stop button)

18.1 Counter Configuration

To enable the counter function:

1. Touch **Analysis > Counter** on the menu bar.
 - The **Counter** menu shown in figure 18.1 will be displayed.
2. Touch **Counter** to toggle the counter function on and off.
3. Touch **Mode** to select the counter mode. See section **Mode** for more details.
4. Touch **Source** to select an analog channel.
5. Touch **Level** to adjust the level of the counter using the **Universal Knob** or the virtual keypad.
6. Touch **Statistics** to toggle the statistics table on and off.
7. Touch **Reset Statistics** to reset the count used to calculate the statistics values.
 - Pressing the **Clear Sweeps** key will also restart statistics.

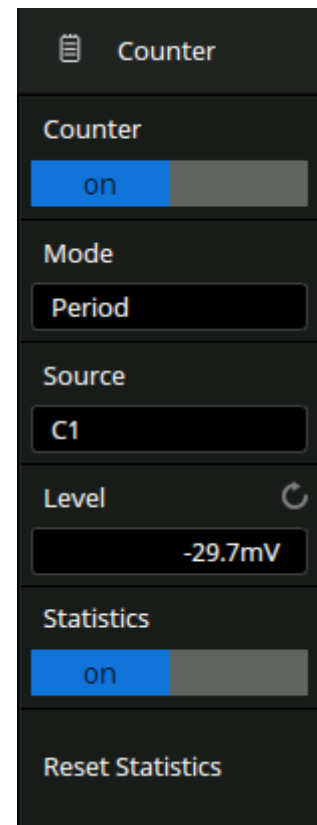

Figure 18.1 Counter Menu

Statistics

When statistics are enabled, the counter will increment the data and display the statistics results on the screen.

COUNTER	Period
Value	999.9981us
Mean	999.9998us
Min	999.9893us
Max	1.000008ms
Stdev	3.528897ns
Count	322

Figure 18.2 Statistics Table

- **Value:** The latest count
- **Mean:** The average of all historical counts
- **Min:** The minimum of all historical counts
- **Max:** The maximum of all historical counts
- **Stdev:** The standard deviation of all historical counts, used to judge the distribution of historical count parameters
- **Count:** Number of counts obtained

18.2 Mode

The counter provides 3 modes. Touch mode in the **Counter** menu to open the mode selection window:

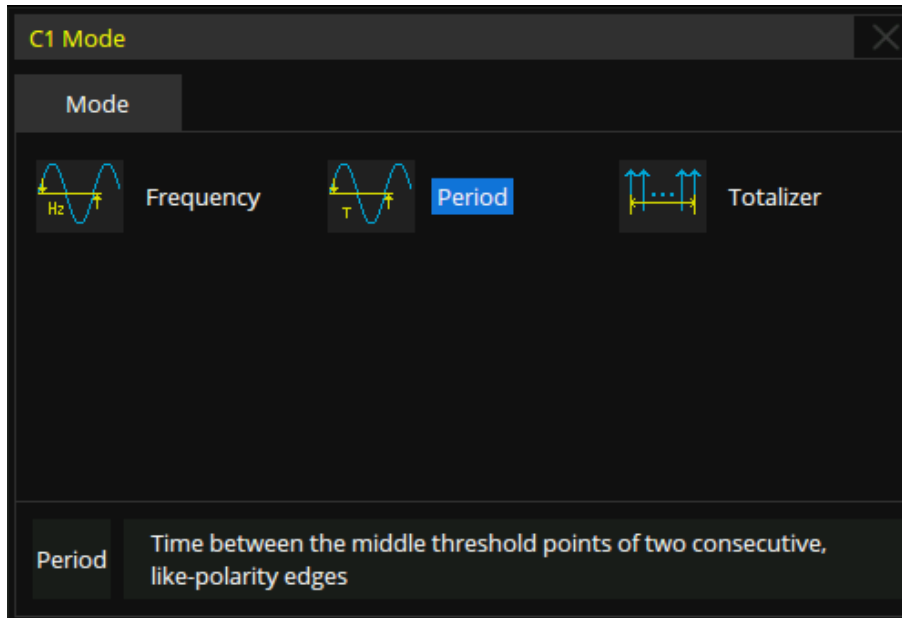

Figure 18.3 Mode Window

- **Frequency:** Average frequency over a period of time
- **Period:** The reciprocal of the average frequency over a period of time
- **Totalizer:** Cumulative count

When mode is set to totalizer, the edge of the counting source needs to be set. When the counting gate is turned on, the counter can count only when the gate-source meets the specified conditions. Touch Gate Setting to display the counter gate menu.

1. Touch **Gate** to toggle on and off the gate.
2. Touch **Type** to toggle between **Level** and **After Edge** gate type.
3. Gate source display area. C1 and C2 are gate sources of each other, C3 and C4 are gate sources of each other
4. Touch **Polarity** when type level is set to level to toggle between **Positive** and **Negative** polarity of the gate-source.
 - When the gate type is edge, set the slope **Rising** or **Falling** edge of the gate source.
5. Touch **Level** and turn the **Universal Knob** or use the virtual keypad to set the gate level.

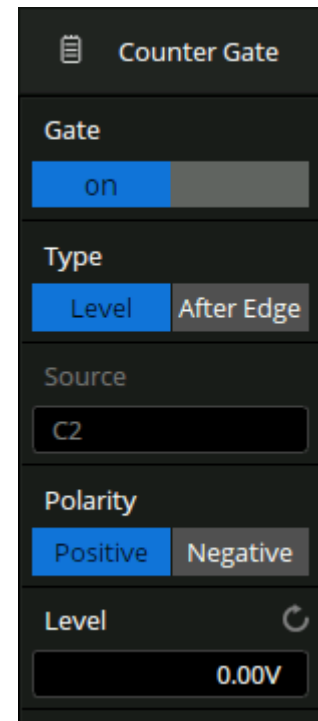

Figure 18.4 Counter Gate Menu

Power Analysis

The 2560B series supports a power analysis function. Power analysis can help users quickly and easily analyze and debug switching power supply designs. It automatically calculates Power Quality, Current Harmonics, Inrush Current, Switching Loss, Slew Rate, Modulation, Turn On/Turn Off, Transient Response, PSRR, Power Efficiency, Output Ripple, etc. Full use of the Power analysis requires a differential voltage probe, a current probe, and a deskew fixture.

Touch **Analysis > Power Analysis** to view the **Power Analysis** menu.

Touch **Analysis** to view the available analysis option.

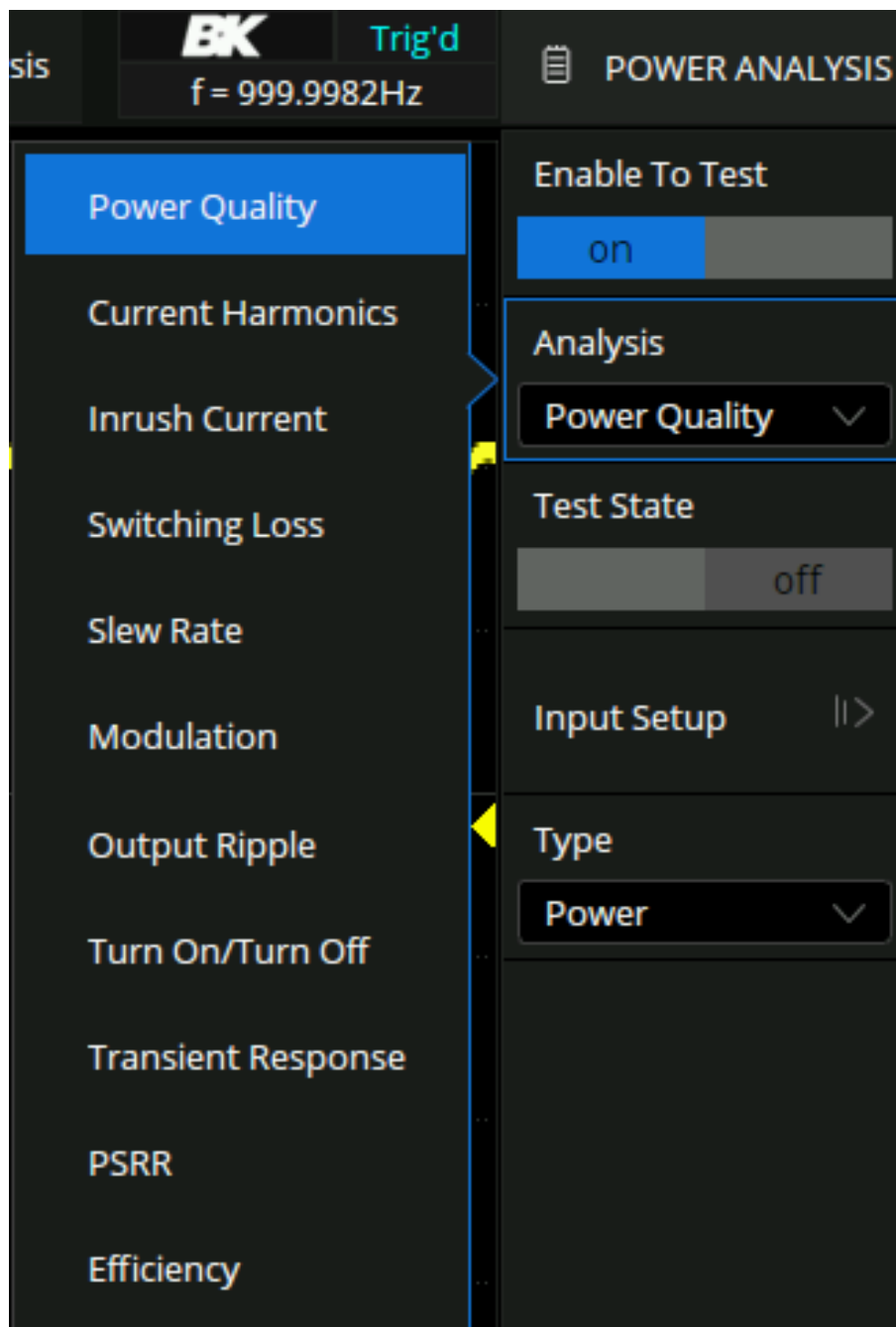

Figure 19.1 Analysis

19.1 Power Quality

The specific measurement parameters of power quality analysis include active power, apparent power, reactive power, power factor, power phase angle, voltage effective value, current effective value, voltage crest factor and current crest factor of power input of a switching power supply.

19.1.1 Type

Power

Includes all the items to describe energy flow in a system: Active power, reactive power, apparent power, power factor and power phase angle.

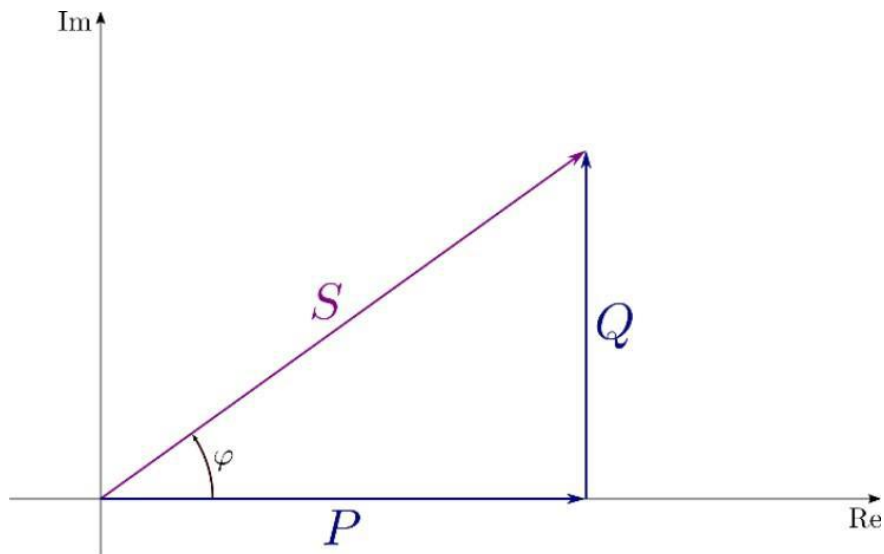

$$P : \text{Active Power} = \frac{1}{N} \sum_{i=0}^{n-1} V_i * I_i$$

$$S : \text{Apparent Power} = V_{rms} * I_{rms}$$

$$Q : \text{Reactive Power} = \sqrt{\text{Apparent Power}^2 - \text{Active Power}^2}$$

φ : Power Phase Angle : Phase difference between voltage and current

$\cos \varphi$: Power Factor, which is the ratio of active power and apparent power.

Voltage Crest

Voltage parameters of the power input including voltage crest, voltage effective value, and voltage crest factor.

$$V_{rms} = \frac{1}{N} * \sqrt{\sum_{i=0}^{n-1} V_i^2}$$

$$V_{Crest} = \frac{V_{peak}}{V_{rms}}$$

Current Crest

Current parameters of the power input including current crest, current effective value, and current crest factor.

$$I_{rms} = \frac{1}{N} * \sqrt{\sum_{i=0}^{n-1} I_i^2}$$

$$I_{Crest} = \frac{I_{peak}}{I_{rms}}$$

19.1.2 Input Setup

1. Touch **Input Setup** to display the signal menu shown in figure 19.3.
2. Touch **Input Voltage** to set the input voltage source.
3. Touch **Input Current** to set the input current source.
4. Touch **Period** to set the periods displayed.
5. Touch **Connection Guide** to display a diagram illustrating the procedure setup. See figure 19.2

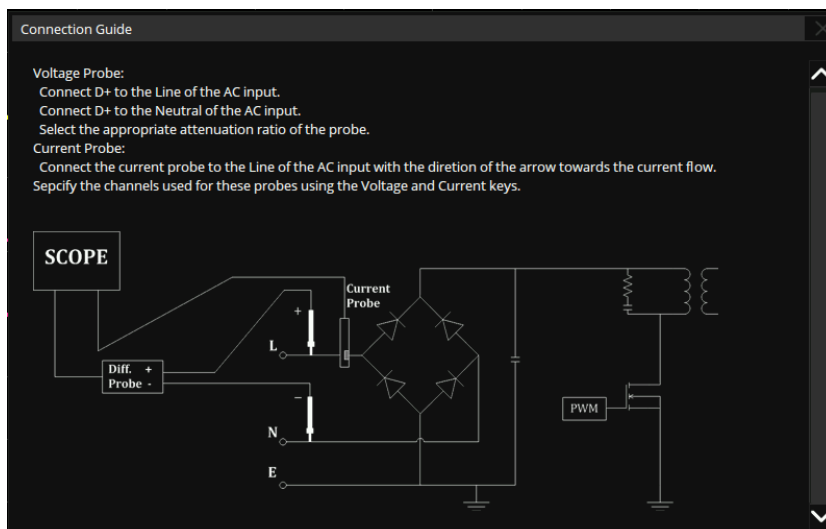

Figure 19.2 Connection Guide

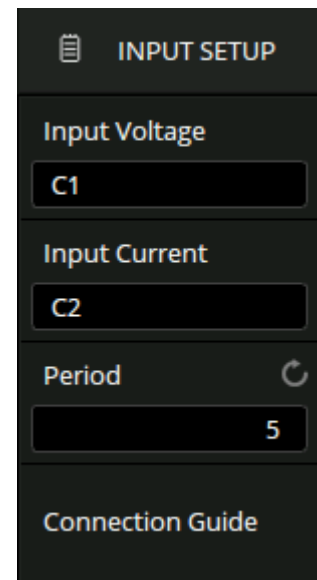

Figure 19.3 Input Setup Menu

19.2 Current Harmonics

Current harmonics is used to analyze the input current harmonics. An FFT of the selected channel is performed to get the harmonic components. The signal settings and connection guide are the same as the power quality test.

19.2.1 Configuration

To configure the current harmonics analysis:

1. Touch **Config** to display the Config menu shown in figure 19.4
2. Touch **Frequency** to set the frequency of the line.
 - Auto, 50 Hz, 60 Hz or 400 Hz
3. Touch **Standard** to set the standard type.
 - IEC61000-3-2 A, IEC61000-3-2 B, IEC61000-3-2 C or IEC61000-3-2 D
4. Touch **Display** to set the display type.
 - Off, Bar Chart or Table



Figure 19.4 Harmonics Analysis Menu

19.2.2 Standard

IEC 61000-3-2 is an international standard that limits mains voltage distortion by prescribing the maximum value for harmonic currents from the second harmonic up to and including the 40th harmonic current. There are 4 different classes in the EN 61000-3-2 that have different limit values:

- **Class A:** Balanced 3-phase equipment, household appliances excluding equipment identified as class D, tools, excluding portable tools, dimmers for incandescent lamps, audio equipment, and all other equipment, except that stated in one of the following classes.
- **Class B:** Portable tools, arc welding equipment which is not professional equipment
- **Class C:** Lighting equipment.
- **Class D:** PC, PC monitors, radio, or TV receivers. Input power P 600 W.I

19.2.3 Parameter Description

For the first 40 harmonics, the following values are displayed:

- **Measured Value (RMS):** The measured value displayed in the unit specified by the harmonic unit parameter
- **Limit Value (RMS):** Limits specified by the selected standard
- **Margin (%):** The margin specified by selected standard parameters. The margin value is (standard value - measured value) / standard value * 100%
- **Pass/Fail State:** Determine whether the measured value is passed or failed according to the selected standard. The rows in the table or the bars in the bar chart are rendered in different colors based on the pass / fail state. When the value is greater than 85% of the limit but less than 100% of the limit, it is defined as a critical state.
- **Total Harmonic Distortion(THD):**

$$= 100 \% * \frac{\sqrt{X_2^2 + X_3^2 + \dots + X_n^2}}{X_1}$$

where X_n is the nth harmonic, and X_1 is the basic component.

19.2.4 Input Setup

1. Touch **Input Setup** to display the signal menu shown in figure 19.6.
2. Touch **Input Voltage** to set the input voltage source.
3. Touch **Input Current** to set the input current source.
4. Touch **Period** to set the periods displayed.
5. Touch **Connection Guide** to display a diagram illustrating the procedure setup. See figure 19.5

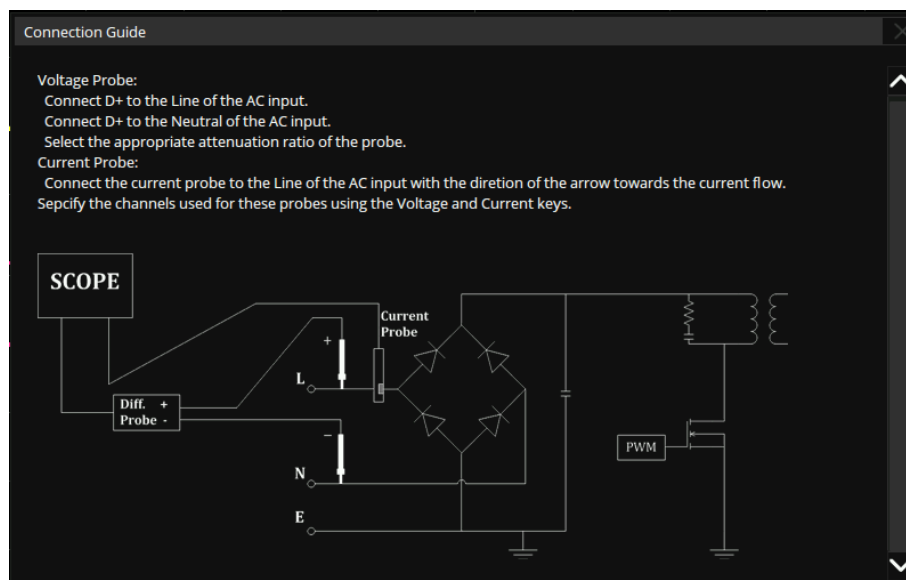

Figure 19.5 Connection Guide

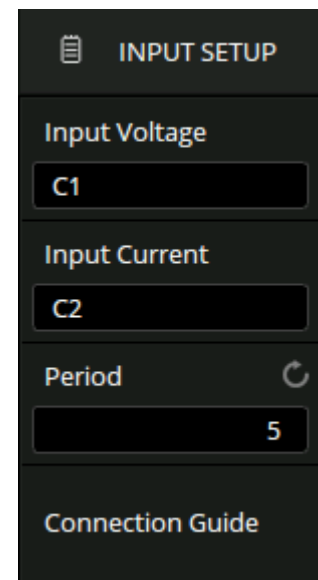

Figure 19.6 Input Setup Menu

19.3 Inrush Current

A large current far greater than the stable current may flow through at the moment of switching on a power supply. The large current is called inrush current. The current waveform when switching on is shown in figure 19.7

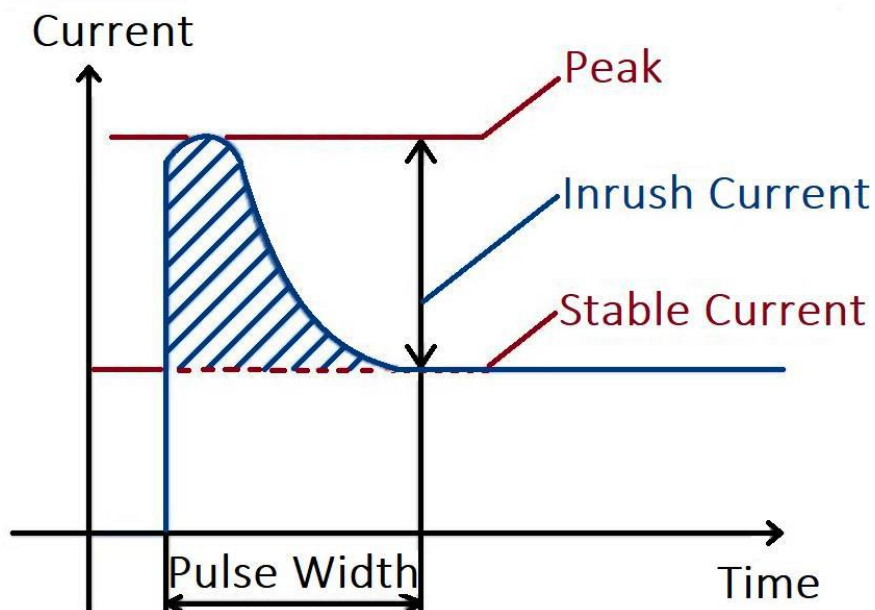

Figure 19.7 Inrush Current

19.3.1 Input Setup

1. Touch **Input Setup** to display the signal menu shown in figure 19.8.
2. Touch **Input Voltage** to set the input voltage source.
3. Touch **Input Current** to set the input current source.
4. Touch **Expected I** to set the expected current value.
 - The range is 100 mA to 500 A.
 - The oscilloscope will set the trigger level to expected current/20 and the vertical scale of the current channel to expected current/3.
5. Touch **Max V in (RMS)** to set the maximum effective input voltage (V_{rms}).
 - The range is 1 V to 1 kV.
 - The oscilloscope will set the vertical scale of the voltage
6. Touch **Connection Guide Inrush** to display a diagram illustrating the procedure setup. See figure 19.9

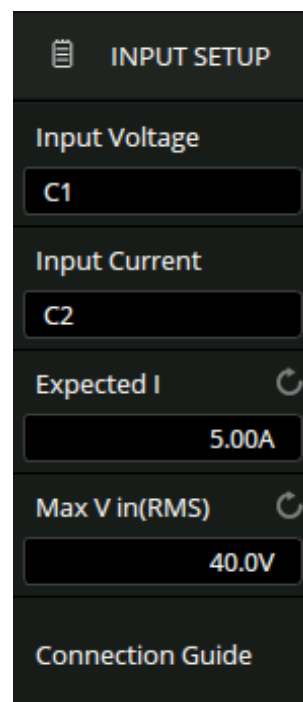

Figure 19.8 Input Setup Menu

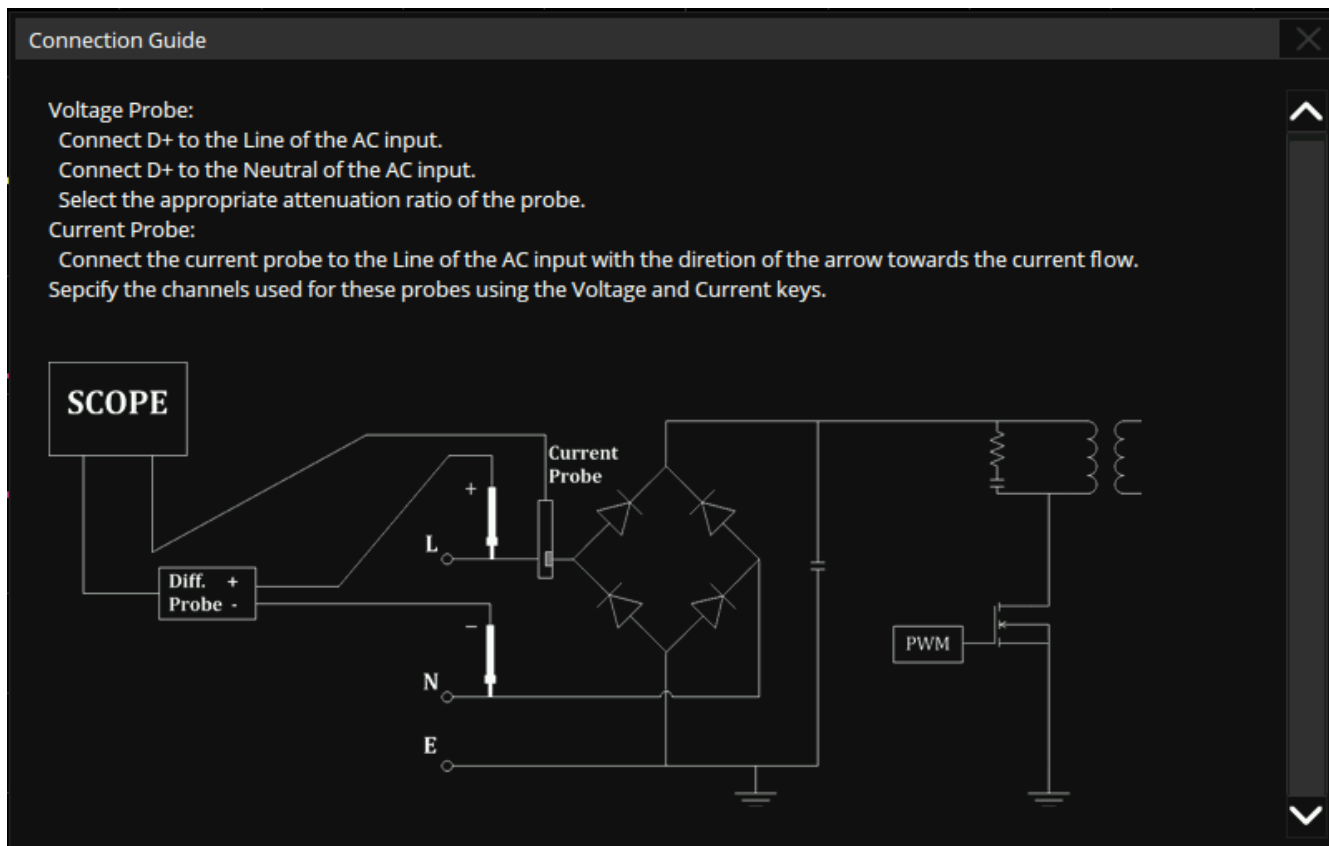

Figure 19.9 Connection Guide

19.4 Switching Loss

Switch loss analysis can be used to calculate the power dissipated in the switching period.

19.4.1 Deskew Calibration

A relatively small skew can cause a large measurement error of switching loss, especially during the on phase when the voltage is close to zero and the non-on phase when the current is close to zero. This is a typical oscilloscope dynamic range limitation when trying to measure weak voltage and (or) current in the presence of relatively large switching voltage and (or) current.

To correct the skew between the oscilloscope channels or probes, the deskew procedure should be performed once initially, and re-run when any part of the hardware setup changes (for example, a different probe, different oscilloscope channel, etc.) or when the ambient temperature changes.

Note:

The deskew procedure may vary based on the deskew fixture used.

19.4.2 Switching Loss Configuration

To configure the switching loss configuration

1. Set **Analysis** to **Switching Loss** in the power analysis menu.
2. Touch **Config** to display the switching loss configuration menu shown in figure 19.10.
3. Touch **V Ref** to set the voltage reference, i.e. the switch level at the edge of the input switch.
 - This value is a percentage of the maximum switching voltage.
 - Adjusting the value to ignore background noise.
 - This value is used to determine the threshold hysteresis of the switch edge
4. Touch **I Ref** to set the current reference, i.e. the switch level at the beginning of the input switch edge.
 - This value is the percentage of the maximum switching current.
 - This value can be adjusted to ignore background noise or invalid offset that is difficult to eliminate in the current probe.
 - This value is used to determine the threshold hysteresis of the switch edge
5. Touch **Conduction** to set the conduction type.
 - Waveform, Rds(on) or Vce(sat)
6. Touch **Rds(On)** and turn the **Universal Knob** or use the virtual keypad to set the Rds resistance.
7. Touch **Vce(Sat)** and turn the **Universal Knob** or use the virtual keypad to set the Vce voltage.

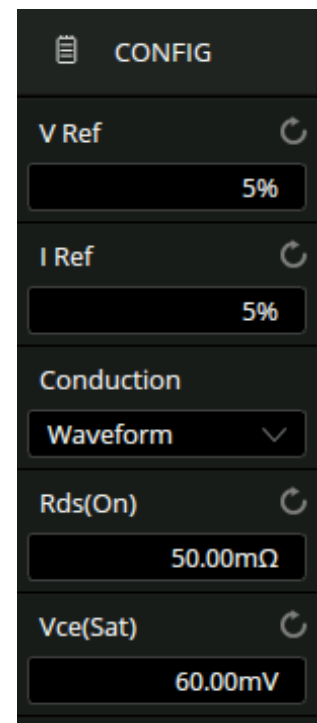

Figure 19.10 Switching Loss Config Menu

19.4.3 Conduction Type

- **Waveform**: The power waveform uses the original data, and the calculation formula is $P = V * I$, $E = P * T$.
- **Rds (on)**: In the on area (where the voltage level is lower than the voltage reference (adjustable)), the power calculation formula is $P = I^2 * Rds (on)$. In the off area (where the current level is lower than the current reference (adjustable)), the power calculation formula is $P = 0$ watt.
- **Vce (sat)**: In the on area (where the voltage level is lower than the voltage reference (adjustable)), the power calculation formula is $P = Vce (sat) * I$. In the off area (where the current level is lower than the current reference (adjustable)), the power calculation formula is $P = 0$ watt.

19.4.4 Input Setup

1. Touch **Input Setup** to display the signal menu shown in figure 19.11.
2. Touch **Input Voltage** to set the input voltage source.
3. Touch **Input Current** to set the input current source.
4. Touch **Auto Deskew** to automatically deskew.
5. Touch **Connection Guide** to display a diagram illustrating the procedure setup. See figure 19.12

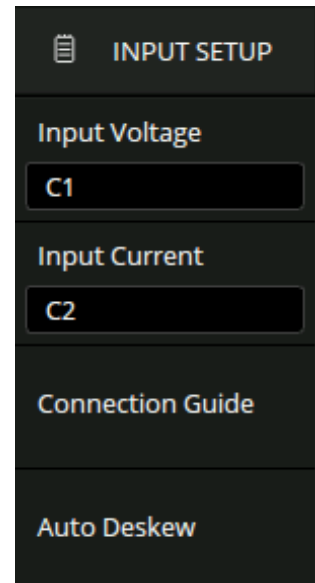

Figure 19.11 Input Setup Menu

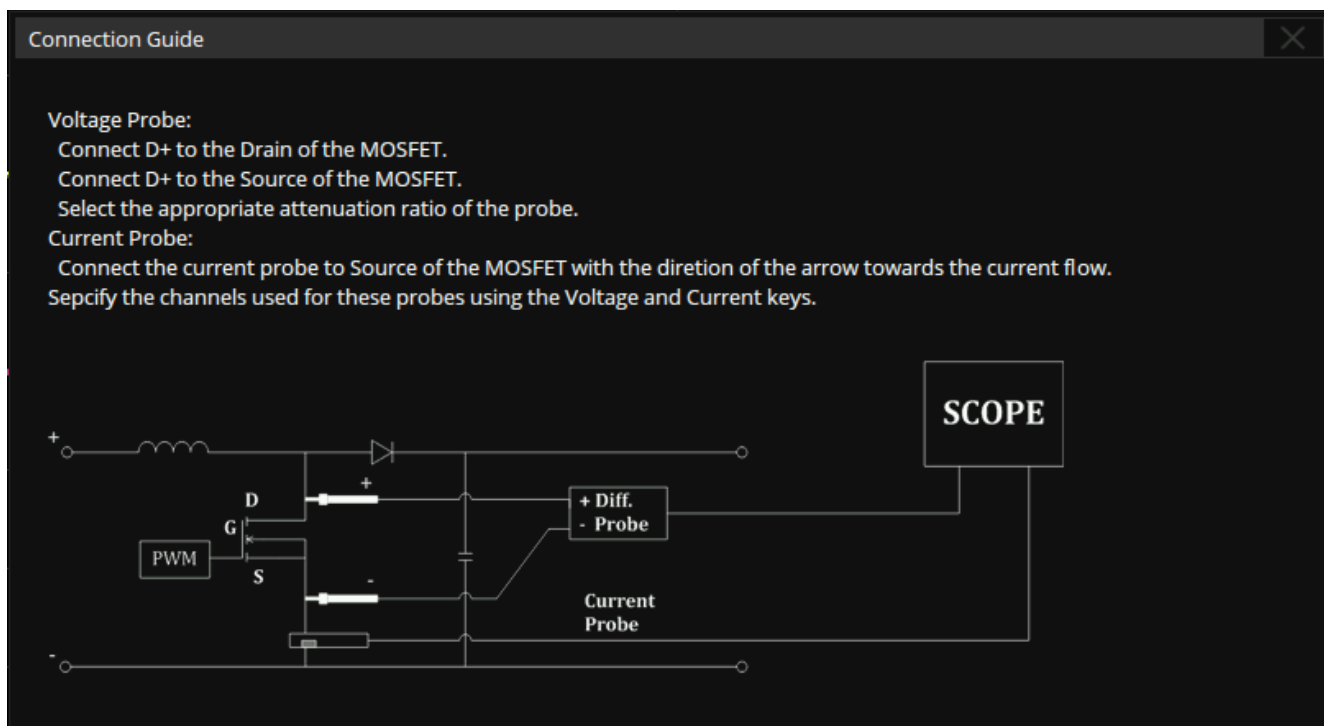

Figure 19.12 Connection Guide Switching Loss

19.5 Slew Rate

The slew rate measures the change rate of voltage or current during switching.

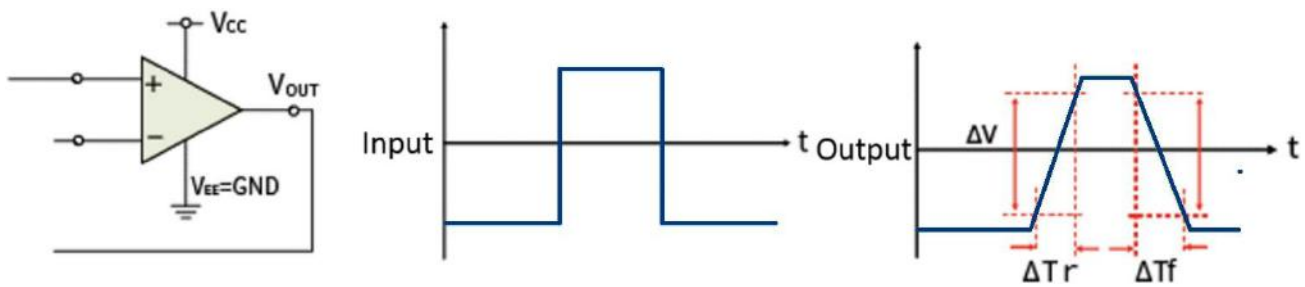

Figure 19.13 Slew Rate

19.5.1 Connection Guide

Touch **Signal > Connection Guide** to recall the connection guide of slew rate, as shown in figure 19.14. Follow the instructions in the figure for connection. Touch the icon on the top right of the guide to close.

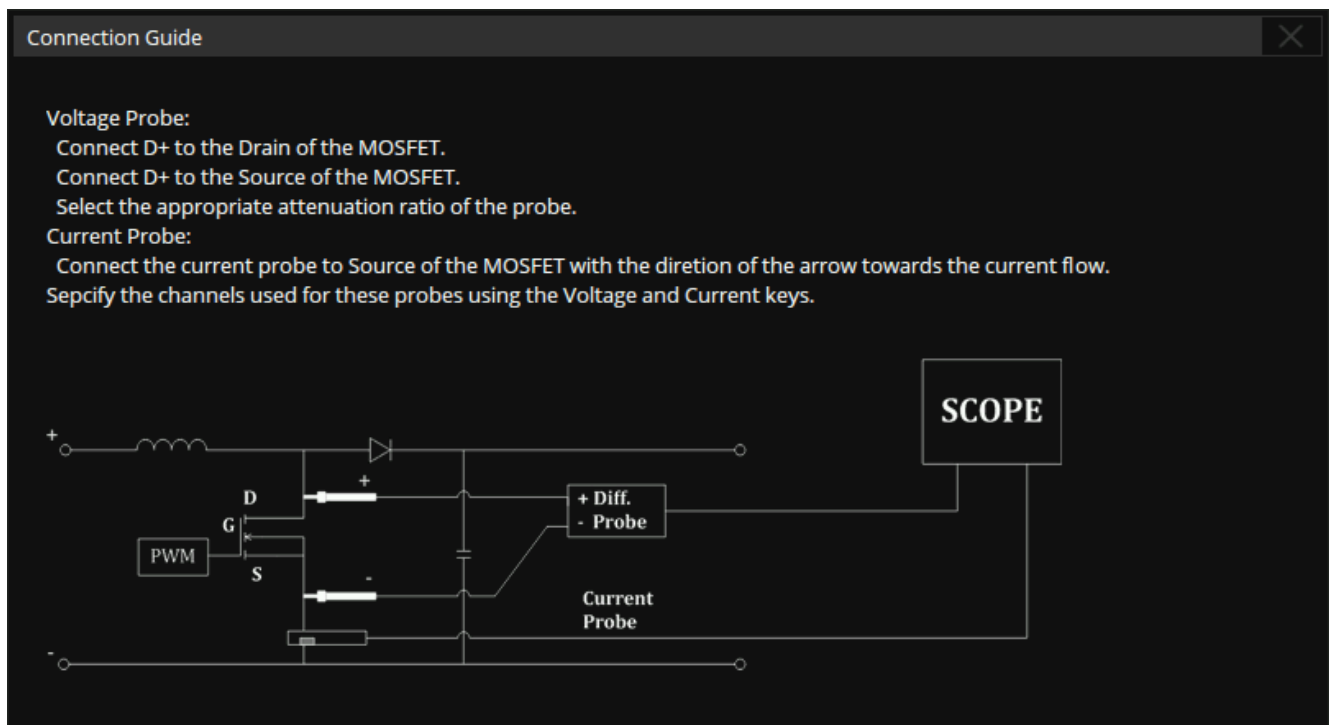

Figure 19.14 Slew Rate Connection Guide

19.6 Modulation

Modulation analysis measures the control pulse signal of the switching device (MOSFET) and observes the pulse width, duty, period, frequency and other trends of the control pulse signal in response to different events.

19.6.1 Input Modulation

1. Touch **Input Setup** to display the signal menu shown in figure 19.15.
2. Touch **Input Voltage** to set the input voltage source.
3. Touch **Input Current** to set the input current source.
4. Touch **Duration** and turn the **Universal Knob** or use the virtual numeric keypad to set the duration time.
5. Touch **Connection Guide** to display a diagram illustrating the procedure setup. See figure 19.16

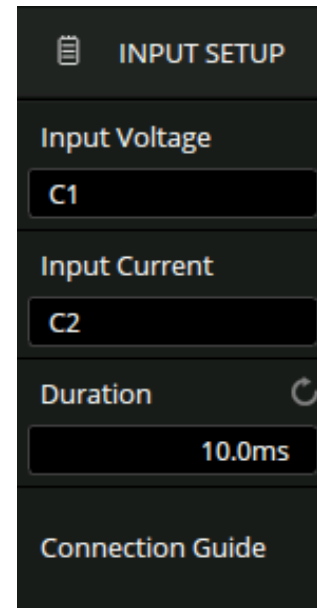

Figure 19.15 Input Setup Menu

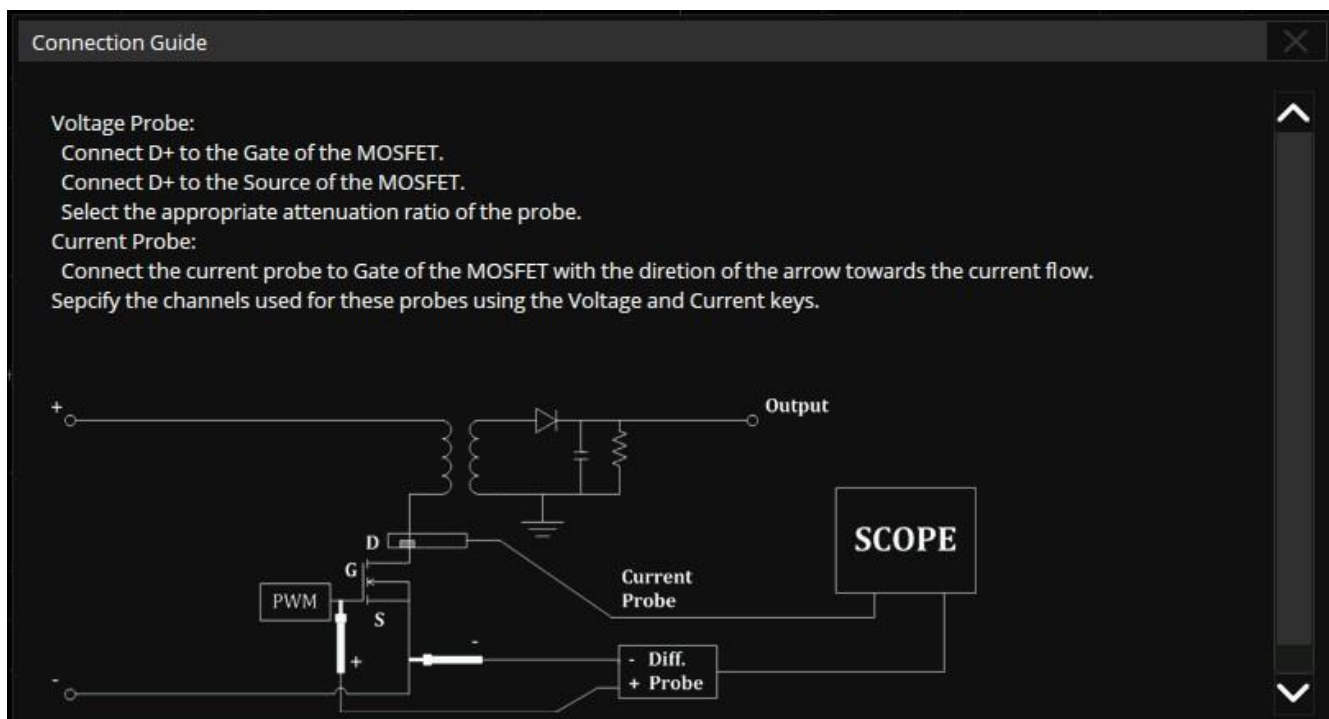

Figure 19.16 Connection Guide

19.7 Output Ripple

Power supply ripple is an important parameter to evaluate DC power supplies, which represents the quality of output DC voltage. Ripple analysis can measure the current value, average value, minimum value, maximum value, standard deviation and count of the power supply output ripple.

19.7.1 Output Ripple Input Setup

1. Touch **Input Setup** to display the signal menu shown in figure 19.17.
2. Touch **Output Voltage** to set the input voltage source.
3. Touch **Duration** and turn the **Universal Knob** or use the virtual numeric keypad to set the duration time.
 - the range is 5 ns – 20 s. The oscilloscope will set the timebase according to the value (duration / 10)
4. Touch **Connection Guide** to display a diagram illustrating the procedure setup. See figure 19.18

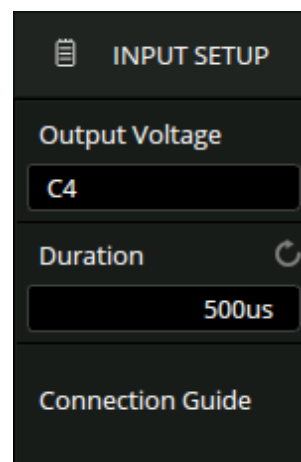

Figure 19.17 Input Setup Menu

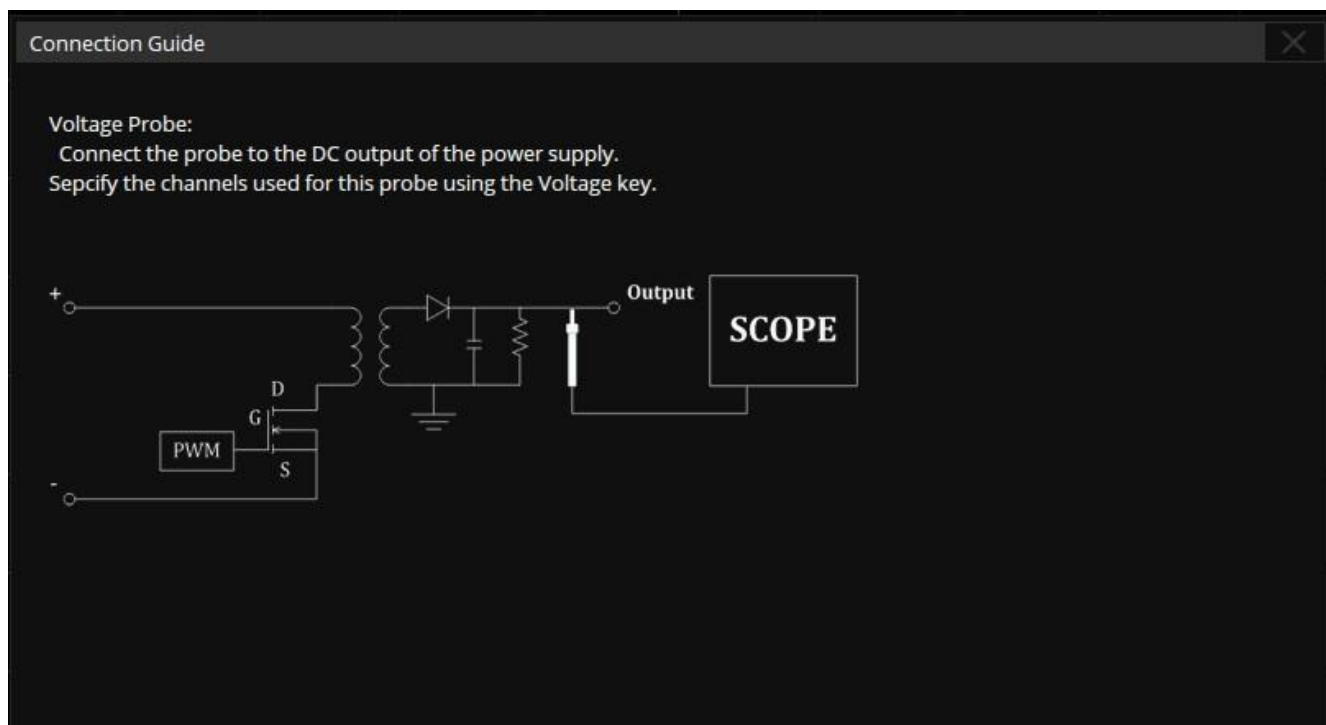

Figure 19.18 Connection Guide

19.8 Turn on/Turn Off

Turn on analysis determines the time taken for the power supply to reach 90% of its steady-state output. Turn off analysis determines the time taken for the power supply to fall to 10% of its maximum output voltage.

19.8.1 Turn On/Turn Off Input Setup

1. Touch **Input Setup** to display the signal menu shown in figure 19.19.
2. Touch **Output Voltage** to set the input voltage source.
3. Touch **Input Type** to toggle the input type between **AC** and **DC**.
4. Touch **Duration** and turn the **Universal Knob** or use the virtual numeric keypad to set the duration time.
 - the range is 5 ns – 20 s. The oscilloscope will set the timebase according to the value (duration / 10)
5. Touch **Max V in (RMS)** and turn the **Universal Knob** or use the virtual numeric keypad to set the maximum effective input voltage (Vrms).
 - The range is 1 V to 1 kV.
 - The oscilloscope will set the vertical scale of the voltage channel to maximum input voltage / 7 and the trigger level to maximum input voltage / 10.
6. Touch **Stable V out** and turn the **Universal Knob** or use the virtual numeric keypad to set the stable output voltage value.
 - The range is -30 V to 30 V.
 - The oscilloscope will set the vertical scale of the output voltage channel to stable output voltage / 6
7. Touch **Connection Guide** to display a diagram illustrating the procedure setup. See figure 19.20

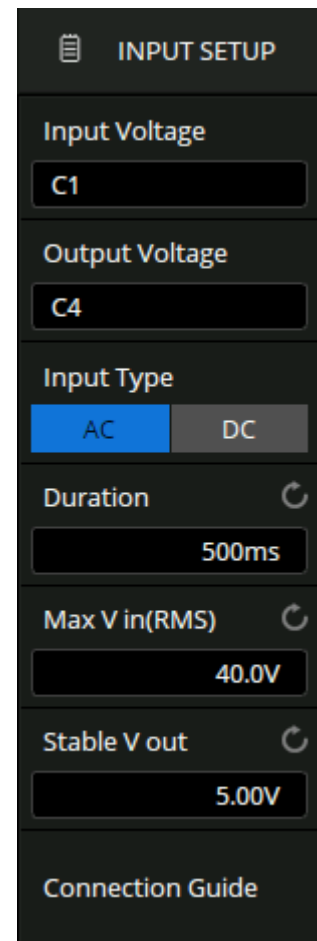

Figure 19.19 Input Setup Menu

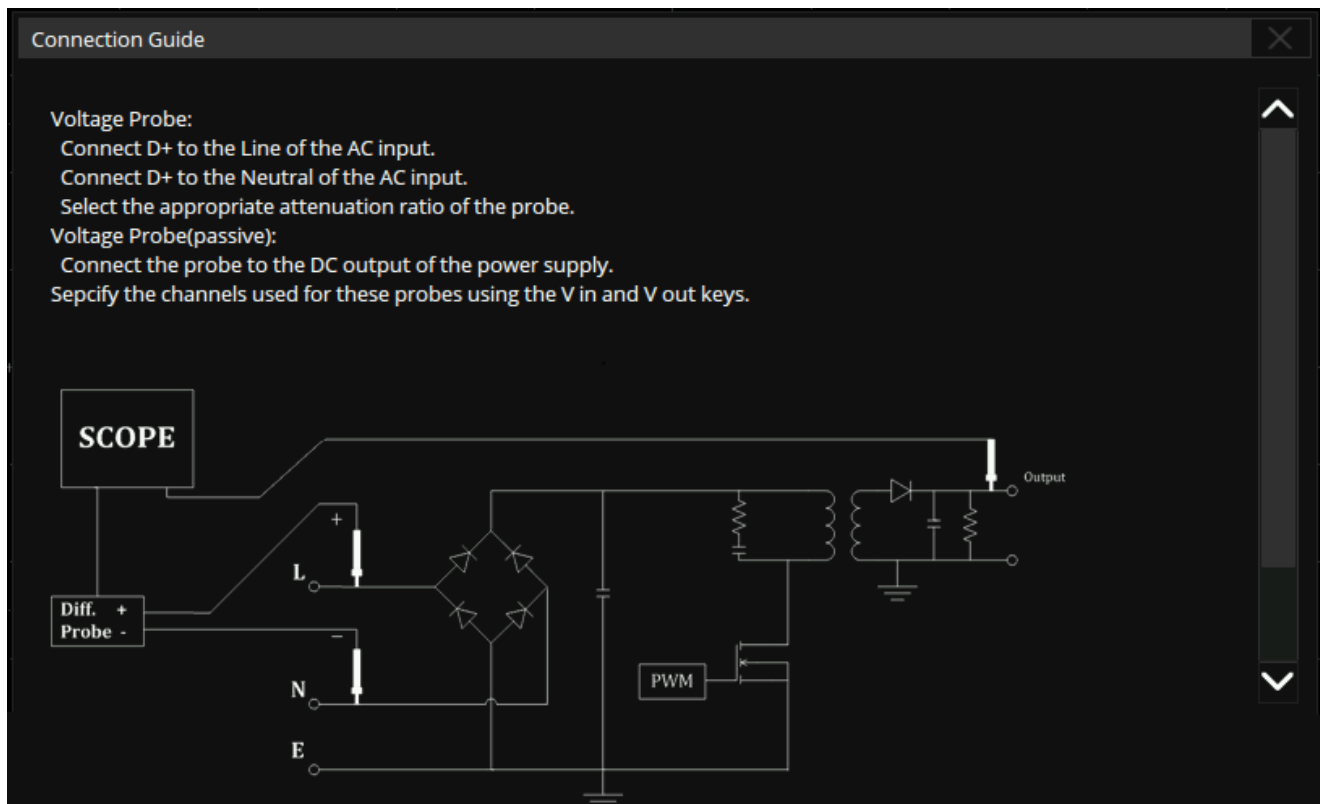

Figure 19.20 Connection Guide

19.8.2 Testing Conditions

Turn On

Determines the time taken for the power to reach a certain percentage of its steady-state output. The turning on time is between T2 and T1, where:

- **T1** = When the input voltage first rises to a certain percentage (usually 10%) of its maximum amplitude
- **T2** = When the output DC voltage rises to a certain percentage (usually 90%) of its maximum amplitude

Turn Off

Defines the time that has elapsed after a power supply has been turned off and has fallen to a certain percentage of its maximum output voltage. The turning off time is between T2 and T1, where:

- **T1** = When the input voltage finally falls to a certain percentage (usually 10%) of its maximum amplitude
- **T2** = When the output DC voltage finally falls to a certain percentage (usually 10%) of its maximum amplitude

19.9 Transient Response

Transient response analysis can determine the response speed of the output voltage of the power supply to the change of the output load. This time starts from the first time that the output voltage exits the stable band and ends at the last time that the output voltage enters the stable band.

19.9.1 Transient Response Input Setup

1. Touch **Input Setup** to display the signal menu shown in figure 19.21.
2. Touch **Output Voltage** to set the output voltage source.
3. Touch **Output Current** to set the output current source
4. Touch **Duration** and turn the **Universal Knob** or use the virtual numeric keypad to set the duration time.
 - the range is 5 ns 20 s.
 - The oscilloscope will set the timebase according to the value (duration / 10)
5. Touch **Stable V out** and turn the **Universal Knob** or use the virtual numeric keypad to set the stable output voltage value.
 - The range is -30 V to 30 V.
 - The oscilloscope will set the vertical scale of the output voltage channel to stable output voltage / 6
6. Touch **Overshoot** and turn the **Universal Knob** or use the virtual numeric keypad to set the overshoot percentage of output voltage.
 - Overshoot can be used to determine the stable band value of transient response and adjust the vertical scale of the oscilloscope.
7. Touch **Connection Guide** to display a diagram illustrating the procedure setup. See figure 19.22

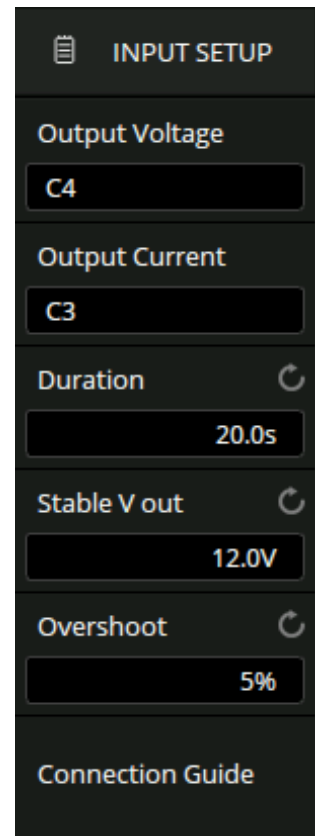

Figure 19.21 Input Setup Menu

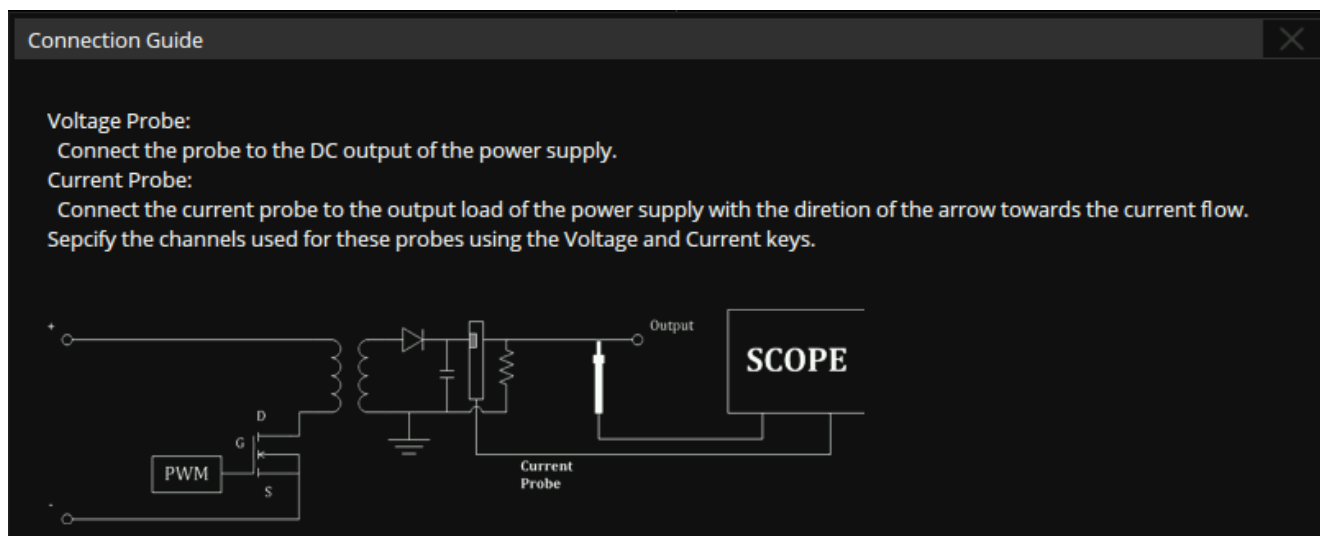

Figure 19.22 Connection Guide

19.9.2 Transient Response Configuration

1. Touch **Config** to display the signal menu shown in figure 19.23.
2. Touch **Low Current** and turn the **Universal Knob** or use the virtual numeric keypad to set the input low current value.
 - This is the expected low current value before or after the load change.
3. Touch **High Current** and turn the **Universal Knob** or use the virtual numeric keypad to set the input high current value
 - This is the expected high current value before or after the load change.

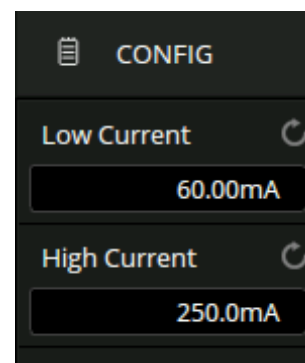

Figure 19.23 Transient Response Configuration Menu

Note:

Low current value and high current value are used to calculate the trigger level and adjust the oscilloscope vertical scale. After the load changes, the current value changes from low to high (or from high to low), and the oscilloscope triggers and performs to measure the transient response stability time.

19.10 PSRR

The power supply rejection ratio (PSRR) test is used to determine how the regulator suppresses ripple noise in different frequency ranges. The oscilloscope controls the arbitrary waveform/function generator to output a sweep signal, which is used to introduce ripple into the DC voltage transmitted to the voltage regulator.

Measure the AC RMS ratio of input to output, and plot the relationship between the ratio and frequency. The background noise of the oscilloscope is higher than that of the network analyzer, and the sensitivity is lower than that of the network analyzer, so the PSRR measured by the oscilloscope is difficult to exceed -60 dB.

The PSRR test is generally acceptable for sampling the overall PSRR behavior of the power supply under test.

19.10.1 PSRR Configuration

The configuration of PSRR is the same as that of the bode plot, see the chapter "[Bode Plot](#)" for details.

19.10.2 PSRR Amplitude

1. Touch **Amplitude** to display the signal menu shown in figure 19.24.
2. Touch **Scale** and turn the **Universal Knob** or use the virtual numeric keypad to set the scale value.
 - The range is .10dB to 20 dB.
3. Touch **Ref Level** and turn the **Universal Knob** or use the virtual numeric keypad to set the reference value.
 - The range is -200 dB to 200 dB
4. Touch **Mode** to toggle between **Vout/Vin** and **Vout** mode.
5. Touch **Axis Type** to toggle the axis type between **Linear** and **Logarithmic**.

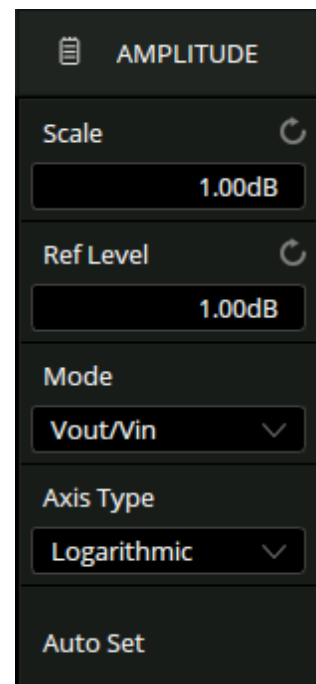

Figure 19.24 PSRR Amplitude Menu

19.11 Power Efficiency

Power efficiency analysis can test the overall efficiency of the power supply by measuring the output power and input power. This analysis is only supported on 4-channel models because all of the input voltage, input current, output voltage, and output current are necessary for the measurement.

19.11.1 Power Efficiency Input Setup

1. Touch **Input Setup** to display the signal menu shown in figure 19.26.
2. Touch **Input Voltage** to set the input voltage source.
3. Touch **Input Current** to set the input current source.
4. Touch **Output Voltage** to set the output voltage source.
5. Touch **Output Current** to set the output current source
6. Touch **Duration** and turn the **Universal Knob** or use the virtual numeric keypad to set the duration time.
 - the range is 5 ns 20 s.
 - The oscilloscope will set the timebase according to the value (duration / 10)
7. Touch **Connection Guide** to display a diagram illustrating the procedure setup. See figure 19.25

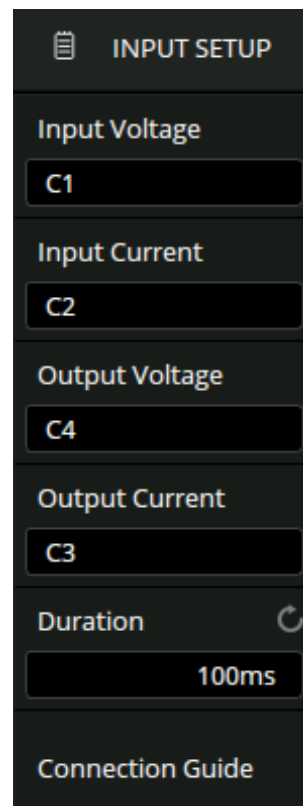

Figure 19.26 Input Setup Menu

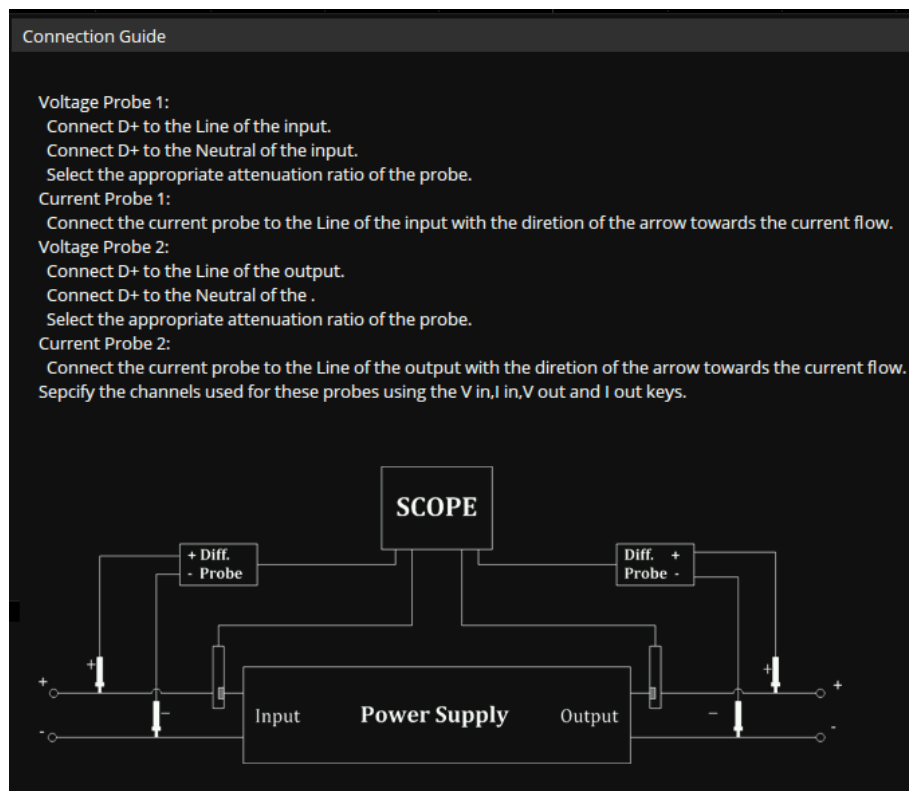

Figure 19.25 Connection Guide Power Efficiency

Bode Plot

The 2560B supports an automatic bode plot function. This function provides a frequency response curve of the device-under-test as well as the interface for output sweep parameter control and data display settings.

At this time, either the built-in waveform generator or one of a BK Precision series arbitrary function generators are supported. During the sweep, the oscilloscope configures the generator output frequency and amplitude and then compares the input signal to the output of the DUT.

Gain (G) and phase (P) are measured at each frequency and plotted on the frequency response bode plot. When the loop response analysis is complete, the markers on the chart can be moved to see the gain and phase values measured at each frequency point. The scale and offset settings can be adjusted for the amplitude and phase plots.

To enable the **Bode Plot** function:

1. Touch **Analysis > Bode Plot** to display the bode plot menu.
2. The **Bode Plot** menu shown in figure 20.1 menu will be displayed.
3. Touch **Bode Plot** to toggle the bode plot on and off.
4. Touch **Configure** to configure the bode plot.
 - The bode plot configuration includes the DUT, AWG connection, and sweep parameters
5. Touch **Operation** to toggle the bode plot operation on and off.
6. Touch **Display** to configure the display parameters.
 - The display parameters include the coordinate axis of bode plot, trace visibility display, and cursors of bode plot. (See section **Bode Plot Configuration** for more details)
7. Touch **Data** to open the data list of bode plot to view the curve data
 - Save the data results to a U-disk or recall it from a U-disk.
8. Touch **Measure** to set the measurement parameters.
 - Parameter measurement of scanning curve includes upper cut-off frequency (UF), lower cut-off frequency (LF), bandwidth (BW), gain margin(GM) and phase margin (PM)

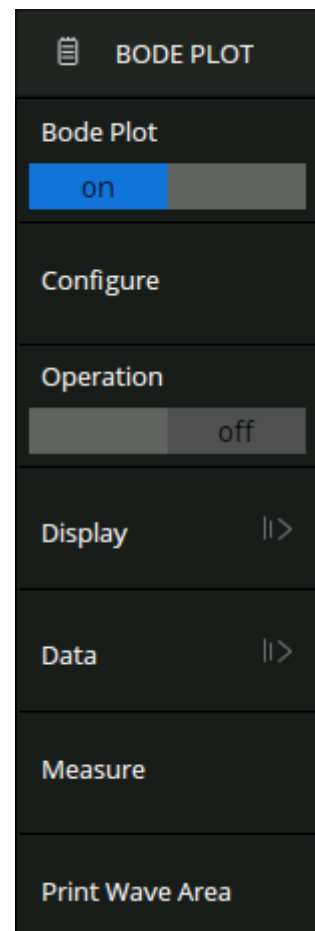

Figure 20.1 Bode Plot Menu

20.1 Bode Plot Configuration

Touch **Configure** to display the **Bode Plot Configure Window** shown in figure 20.2

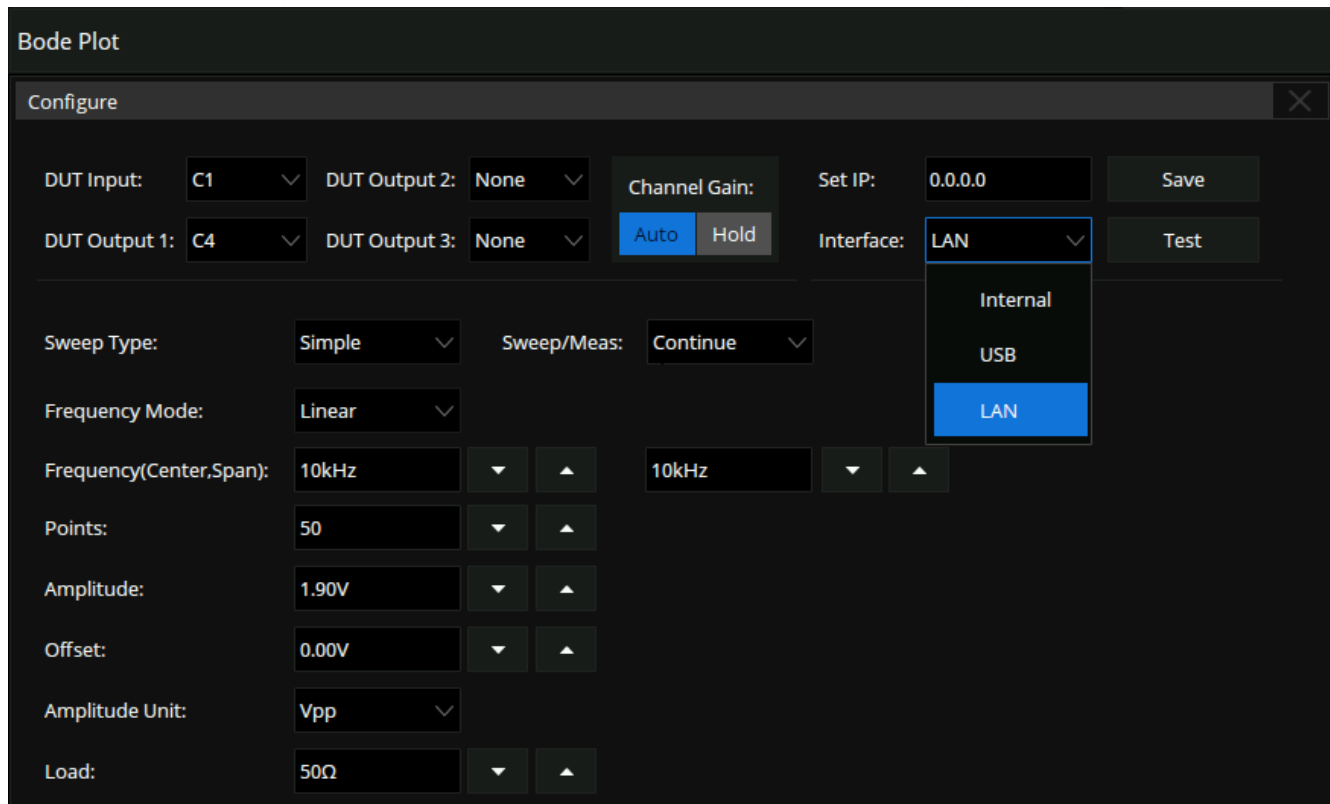

Figure 20.2 Bode Plot Configure Window

20.1.1 Connection

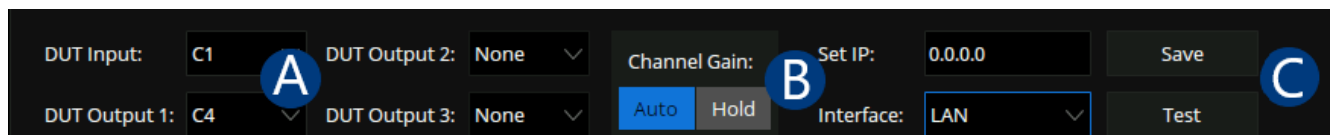

Figure 20.3 Connection

- A. DUT input and output channels
- B. Channel gain. When it is set to Auto, the oscilloscope will automatically adapt the vertical scale according to the signal amplitude. When it is set to Hold, it will always keep the currently selected vertical scale. If signals overload the selected range in Hold mode, the data may not accurately represent the physical test.
- C. Arbitrary waveform generator connection settings. Touch **Interface** to select the connection type. When selecting LAN, it needs to **Set IP** and **Save** it. Touch **Test** to confirm whether the arbitrary waveform generator is connected correctly.

20.1.2 Sweep

Touch **Sweep Type** to select the sweep type. There are two types: **Simple** and **Variable Level**.

20.1.3 Simple Sweep

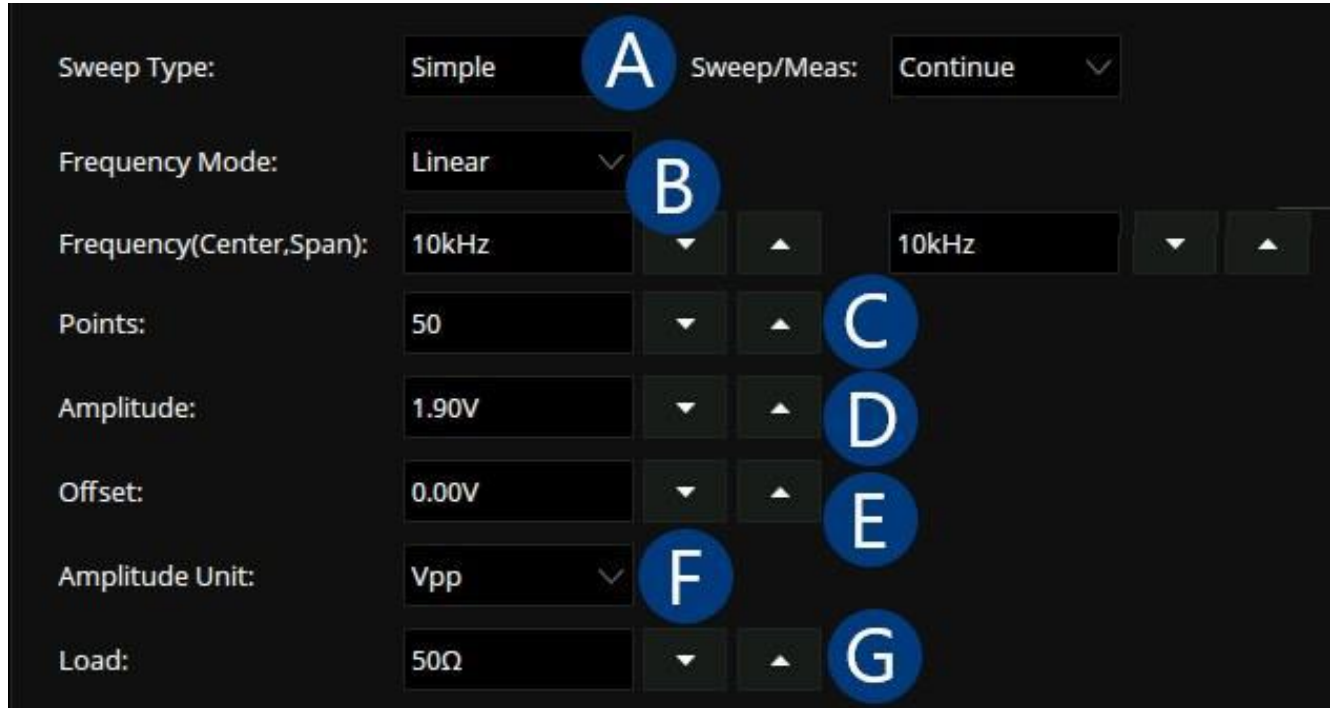

Figure 20.4 Simple Sweep

- Set the sweep type to simple. There are two types: Simple and variable level.
- Set the sweep frequency. The frequency mode can be linear or decade. When it is set to linear, the corresponding center frequency and span frequency need to be set. When it is set to decade, the corresponding start frequency and stop frequency need to be set.
- Set the number of sweep points. The larger the number of points, the higher the sweep resolution.
- Set the amplitude of sweep signal.
- Set the offset of the sweep signal.
- Set the signal amplitude unit. When it is set to dB, reference level and load need to be set.
- Set the load.

Vari-Level Sweep

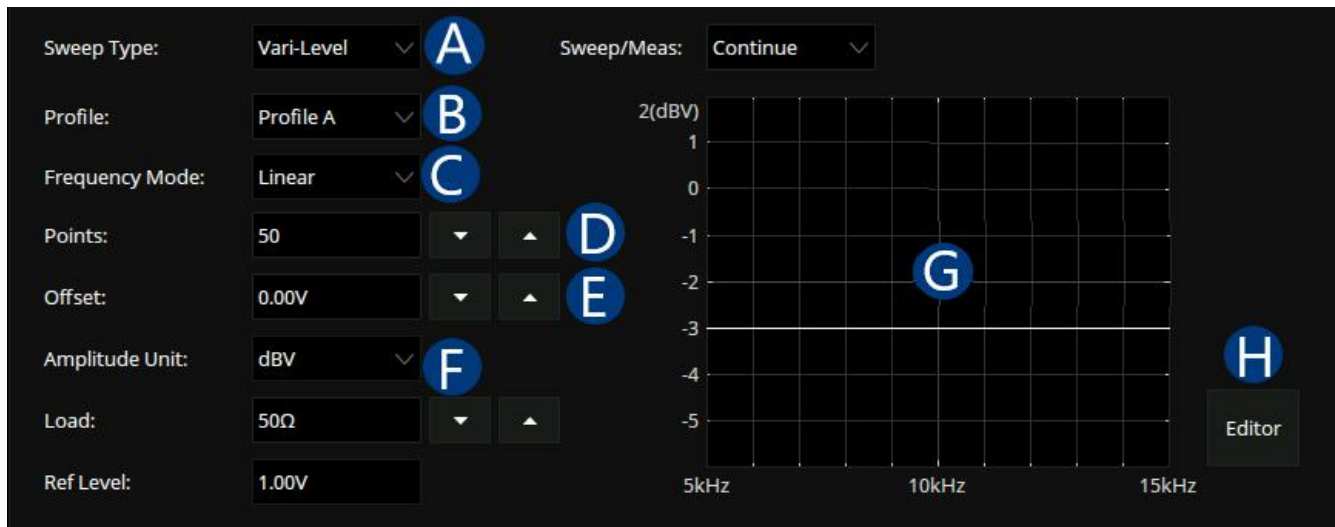

Figure 20.5 Vari-Level Sweep

- A. Set the sweep type to Vari-Level
- B. Select a profile. Up to 4 profiles can be edited
- C. Set the frequency mode
- D. Set the number of sweep points
- E. Set the offset of the sweep signal
- F. Set the signal amplitude unit. When it is set to dB, reference level and load need to be set
- G. Variable level signal display area
- H. Touch **Edit** to turn on the profile editor

20.1.4 Editor

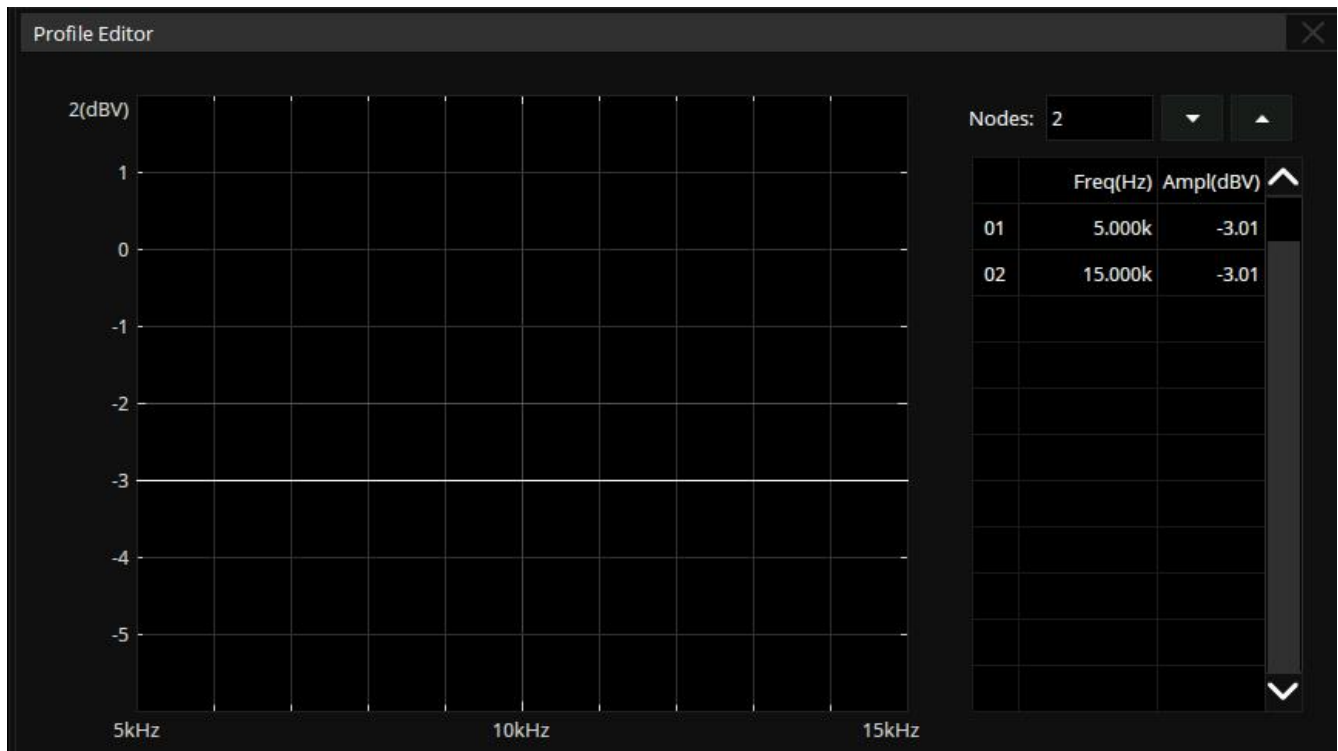



Figure 20.6 Editor

Touch Nodes to set the signal node number through the universal knob, or touch  to increase the nodes and  to decrease.

Touch the cell in the table area to set the frequency and amplitude of the corresponding node. Touch to activate the cell, adjust the value through the universal knob, or touch the cell again to call up the virtual keypad.

Arbitrary Waveform Generator

The 2560B series supports a built-in arbitrary waveform/function generator.

Refer to the datasheet for the detailed specifications of the AWG.

Press the **AWG** key on the front panel, or touch the menu **Utility > AWG** menu to display the AWG menu shown in figure 21.1.

21.1 AWG Configuration

- Touch **Output** to toggle the AWG on and off.
 - For safety, pressing the Wave Gen button does not automatically turn on the output of AWG.
 - When the output is enabled, the Wave Gen button lights up.
- Touch **Wave Type** to select one of the six standard waveforms available.

Wave Type	Parameters
Sine	Frequency, Amplitude, Offset
Square	Frequency, Amplitude, Offset, Duty
Ramp	Frequency, Amplitude, Offset, Symmetry
Pulse	Frequency, Amplitude, Offset, Duty
DC	Offset
Noise	Stdev, Mean
Arb	Frequency, Amplitude, Offset, Arb Type

Table 21.1 Waveforms

- The Arbitrary waveforms consist of two types built-in waveforms and stored waveforms. Touch Arb Type in the AWG dialog box, and select the arbitrary in the pop-up window shown in figure 21.2

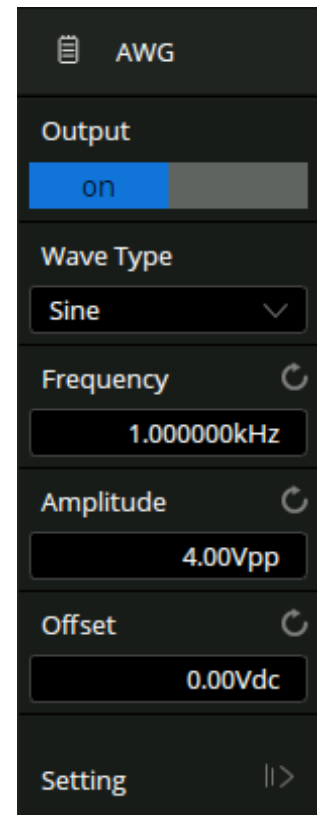

Figure 21.1 AWG Menu

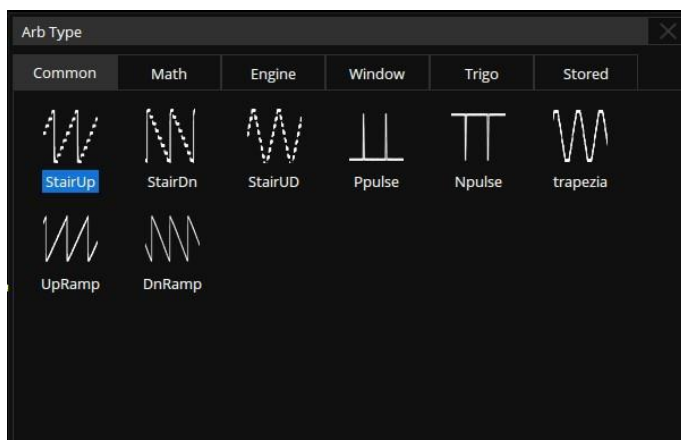

Figure 21.2 Arb Type Window

There are 6 tabs in the window. Under each tab, a catalog of waveforms is listed. Built-in waveforms are stored in Common, Math, Engine, Window, and Trigo.

Stored waveforms are located in the Stored menu. Users can edit arbitrary waveforms using Easy-Wave PC software, and send the stored waveforms to the instrument through the remote interface, or import the stored waveforms through a U disk.

21.1.1 Other Settings

- Touch **Setting** to display the **Other Setting** menu shown in figure 21.3.
- Touch **Output Load** to toggle between 50 Ω and High-Z.
 - The selected output load value must match the load impedance. Otherwise, the amplitude and offset of the output waveform of AWG will be incorrect.
- Touch **OVP** to toggle over voltage protection on and off.
 - When OVP is enabled, the output will be turned off automatically once the protection condition is met.
 - The protection condition is when the absolute value on the output port is higher than $4\text{ V} \pm 0.5\text{ V}$. At the same time, a warning message is displayed.
- Touch **Zero Adjust** to perform a zero adjustment.
 - **Auto Steps:** In this mode, the adjustment can only be performed with CH1 of the oscilloscope. Connect the output of AWG to CH1 of the oscilloscope, press **Auto**, and the AWG will start to automatically adjust. The scope will display "Zero adjust completed!" when the adjustment is done.
 - **Manual Steps:** The AWG can be manually calibrated through any channel on the oscilloscope. Take CH2 as an example:
 1. Connect the output of AWG to CH2, open CH2, set it to DC coupling, turn on bandwidth limit, and set the probe attenuation to 1X.
 2. Set the vertical scale of CH2 to a small scale such as 1mV/div. Turn on measure and set the parameter to Mean of CH2.
 3. Press **Manual** and rotate the universal knob to adjust the compensation value, until the mean value of CH2 is within $\pm 1\text{mV}$, and then press **Save**.
 - The output zero error of the AWG can be calibrated by using auto mode or manual mode.
 - When AWG outputs 0V DC signal, the measured mean value of the corresponding channel is within $\pm 1\text{mV}$.

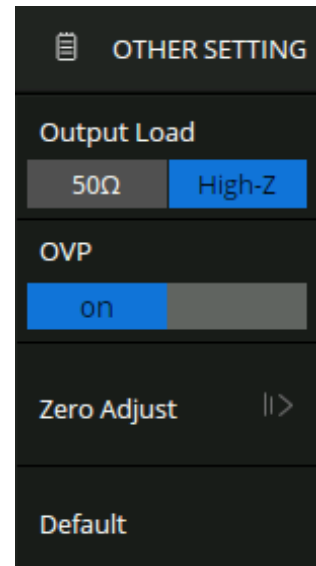

Figure 21.3
Other Setting Menu

Save/Recall

Oscilloscope setups, waveforms, pictures, and CSV files can be saved to internal oscilloscope memory or to a USB storage device. The saved setups, waveforms can be recalled later. The oscilloscope provides a USB Host interface on the front panel to connect an USB device for external storage.

22.1 Save Type

The oscilloscope supports setups, waveforms, pictures and CSV files storage. The default save type is setups.

1. **Setups**

It's the default storage type of the oscilloscope. It saves the settings of the oscilloscope in internal or external memory in "*.SET" format. At most 20 setting files (from No.1 to No.20) can be stored in internal memory. The stored settings can be recalled.

2. **Reference**

The reference waveform data are saved to external memory with the *.ref file extension. The saved file contains the reference waveform data and its setup information such as the vertical scale, vertical position, and timebase.

3. **BMP**

The oscilloscope saves the screen image in external memory in "*.bmp" format. You can specify the file name and saving directory under the same directory using the same file name. The recall of image is not supported.

4. **JPG**

The oscilloscope saves the screen image in external memory in "*.jpg" format. You can specify the file name and saving directory under the same directory using the same file name. The recall of image is not supported.

5. **PNG**

The oscilloscope saves the screen image in external memory in "*.png" format. You can specify the file name and saving directory under the same directory using the same file name. The recall of image is not supported.

6. **Binary**

The oscilloscope saves the waveform data in external memory in "*.BIN" format. The data of all the channels turned on can be saved in the same file. The recall of binary is not supported.

7. **CSV**

Saves the waveform data to the external memory in ".csv" format. After selecting this type, you can touch the **ParaSwitch** to determine to include the scope configuration parameter information (horizontal timebase, vertical scale, etc.) or not. Touch the **Save All Channel** to save all displayed waveforms on the screen or select the **Source** to save. The available sources include C1 - C4 and F1 - F2.

8. **MATLAB**

Saves the waveform data to external memory in *.mat format which can be imported by Matlab directly. The available sources include C1 C4 and F1 - F2.

9. **To Default Key**

The oscilloscope provides two options for the default setting. When the Default Type is set to "Factory", the factory default setting will be recalled by pressing the **Default** button on the front panel; When the Default Type is set to "Current", the last setting saved by the "To Default Key" operation will be recalled by pressing the **Default** button on the front panel.

10. **Bin2CSV Tool**

The mini tool is used to convert stored binary files to CSV format for viewing with a spreadsheet program. This is ideal when collecting large datasets. For a waveform frame with deep memory such as 200 Mpts, to save directly as

a CSV file will take long time and will occupy a large amount of memory on a USB storage device. It's recommended to save the data as binary file and then convert it to CSV file on a computer.

Table 22.1 shows the relationship between the save types and save/recall operations.

Type	Save to Internal	Save to External	Recall
Setup	√	√	√
Reference	×	√	√
BMP	×	√	×
JPG	×	√	×
PNG	×	√	×
Binary Data	×	√	×
CSV Data	×	√	×
Matlab Data	×	√	×

Table 22.1 Save/Recall Operations

Note:

*Save/Recall only supports saving Reference to external memory. However, the reference waveform itself can be saved to internal memory. See the chapter Reference for more details.

22.2 Internal/External Save and Recall

Internal save and recall support Setups in **Save/Recall**. In the following part, the save and recall method and procedures are introduced.

Save the specified oscilloscope setting

1. Connect the signal to the oscilloscope and obtain stable display.
2. Press **Save/Recall** key on the front panel to enter the **Save** menu function menu.
3. Touch **Save** to select Save mode.
4. Touch **Type** to select the type of format.
5. Touch **File Manager** to open the file manager window shown in figure 22.3.
6. Touch **Local** to save the file internally or touch the name of the external path to save the file externally.

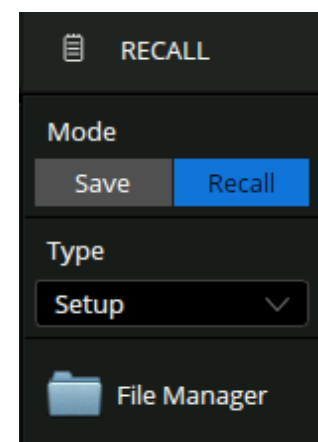

Figure 22.1 Recall

Note:

A progress bar is shown when the Save operation is in progress. When it is done, the oscilloscope prompts "Saved to internal file No.X", where X is the internal storage location index.

Recall the specified oscilloscope setting.

1. Connect the signal to the oscilloscope and obtain stable display.
2. Press **Save/Recall** key on the front panel to enter the **Save** menu function menu.
3. Touch **Recall** to select Save mode.
4. Touch **Type** to select the type of format.
5. Touch **File Manager** to open the file manager window shown in figure 22.3.
6. Touch **Local** to recall the file internally or touch the name of the external path to recall the file externally.

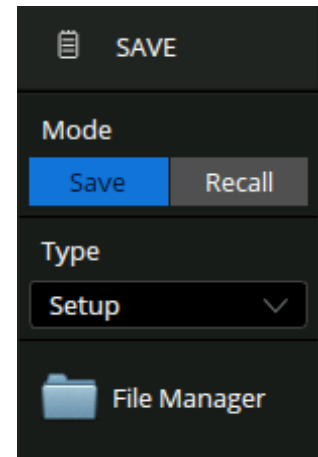

Figure 22.2 Save

Note:

If need to delete a setup file in the memory, please save a new setup to the same location to overwrite it.

22.3 File Manager

The 2560B file manager has similar style and operation with the Windows operating systems.

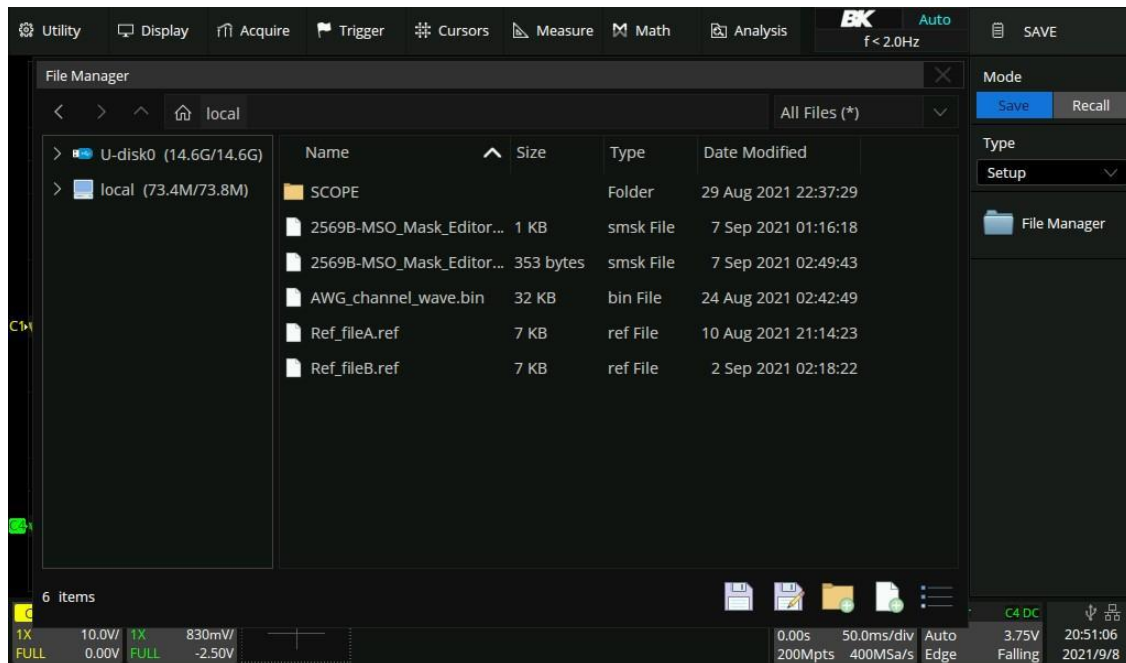



Figure 22.3 File Manager Window

- **Left Window:** Displays a list of available drives and internal folders.
 - The selected folder has an icon with a blue background.
 - The triangle tag on the left of the folder indicates that the folder includes subfolder(s). Clicking the tag expands the folder to show the subfolder(s) in the left window.
- **Right Window:** Displays the files and the subfolders contained in the selected folder.
- **Toolbar:** Graphical commands for file operations.
 - Touch  to edit the available files, create new files or folders, or copy and paste selected files.
- Touch Save As, click the pop-up text box to recall the virtual keyboard and input the file name, and then touch **OK**:

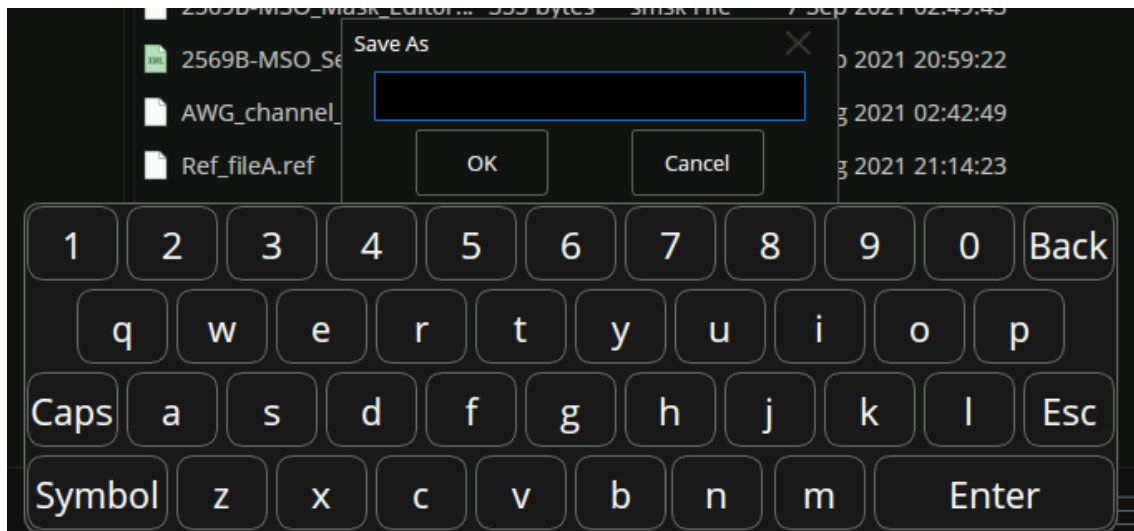

Figure 22.4 Save As

Utility Menu

This function module supports the oscilloscope's system-related function, such as system status, language, sound and some other advanced setting, such as do self-cal, update and remote interface configure.

23.1 System Setting



23.1.1 View System Status

To view the system status:

1. Press the **Utility** key on the front to enter the Utility menu.
2. Touch **System Setting** to view the **System Setting** menu.
3. Touch **System Status** to view the system status of the oscilloscope. The system status includes the information below:
 - *Startup Times*: record the boot-strap times of the oscilloscope.
 - *Software Version*: list the current software version of the oscilloscope.
 - *Uboot-OS Version*: list the current Uboot and OS version of the oscilloscope
 - *FPGA Version*: list the current fpga version of the oscilloscope.
 - *CPLD Version*: list the current CPLD version of the oscilloscope.
 - *Hardware Version*: list the current hardware version of the oscilloscope.
 - *Scope ID*: display the scope ID.
 - *Serial NO.*: list the serial number of the oscilloscope.
 - *Model*: display the product model of the oscilloscope.

23.1.2 Sound

When the sound is enabled, you can hear the sound of the beeper when you press a function key or a menu softkey or when the prompt message pops up.

Press the **Utility** key on the front panel to enter the Utility menu; then touch **Sound** to select  or  to turn off or on the sound.

23.2 Language

The oscilloscope supports multiple languages menus, help and prompt messages.

1. Press **Utility** key on the front panel to enter the Utility menu.
2. Touch **Language** and to select the desired language.

The languages that currently available are Simplified Chinese, Traditional Chinese, English, French, German, Spanish, Russian, Italian, and Portuguese.

23.3 Screen Saver

When the oscilloscope enters the idle state and holds for a certain period of time, the screen saver program will be enabled.

To set the screen saver time:

1. Press the **Utility** key on the front panel to enter the Utility menu.
2. Touch **Screen Saver** and select the desired screen saver time. The screen saver time can be set to **1min, 5min, 10min, 30min, and 1hour**. Also, you can select **Off** to turn off the screen saver function.

23.4 IO Set

The oscilloscope provides the following input output interfaces: USB, LAN, and Aux Output.

23.4.1 LAN

To set the oscilloscope to communicate with PC via LAN:

1. Connect the oscilloscope to your local area network using the network cable.
2. Press the **Utility** key on the front panel to enter the Utility menu.
3. Touch **System Setting** to view the **System Setting** menu.
4. Touch **Web Server** to set a web server password.
5. Touch **IO Set** to enter the I/O Setting menu.
6. Touch **Net Interface LAN** to select LAN.
7. Touch **IP Set** to enter the IP setting interface, see figure 23.2.
8. Touch DHCP softkey to turn on or turn off the DHCP.
 - On: the DHCP server in the current network will assign the network parameters (such as the IP address) for the oscilloscope.
 - Off: set the IP address, subnet mask, gate way manually.

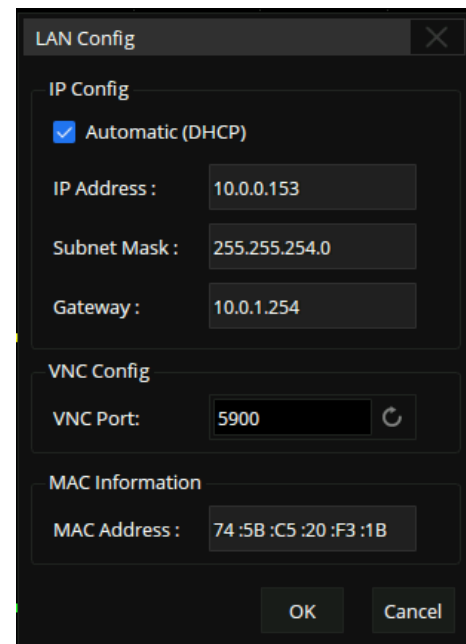

Figure 23.2 IP Set

23.4.2 USB Device

To set the oscilloscope to communicate with a PC via USB:

1. Install the USBTMC device driver on PC. Suggest you install NI Vista.
2. Connect the oscilloscope with PC using a standard USB cable
3. Press the **Utility** key on the front panel to enter the Utility menu.
4. Touch **System Setting** to view the **System Setting** menu.
5. Touch **IO Set** to enter the I/O Setting menu.
6. Touch **USB ID** to view the USB ID

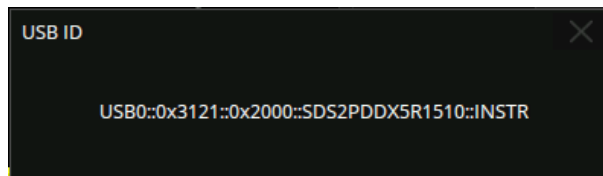

Figure 23.3 USB ID

23.4.3 Date/Time

1. Press the **Utility** key on the front panel to enter the Utility menu.
2. Touch **System Setting** to view the **System Setting** menu.
3. Touch **Date/Time** to display the Date/Time window shown in figure 23.4.
4. Use the virtual keypad to edit the date and time.

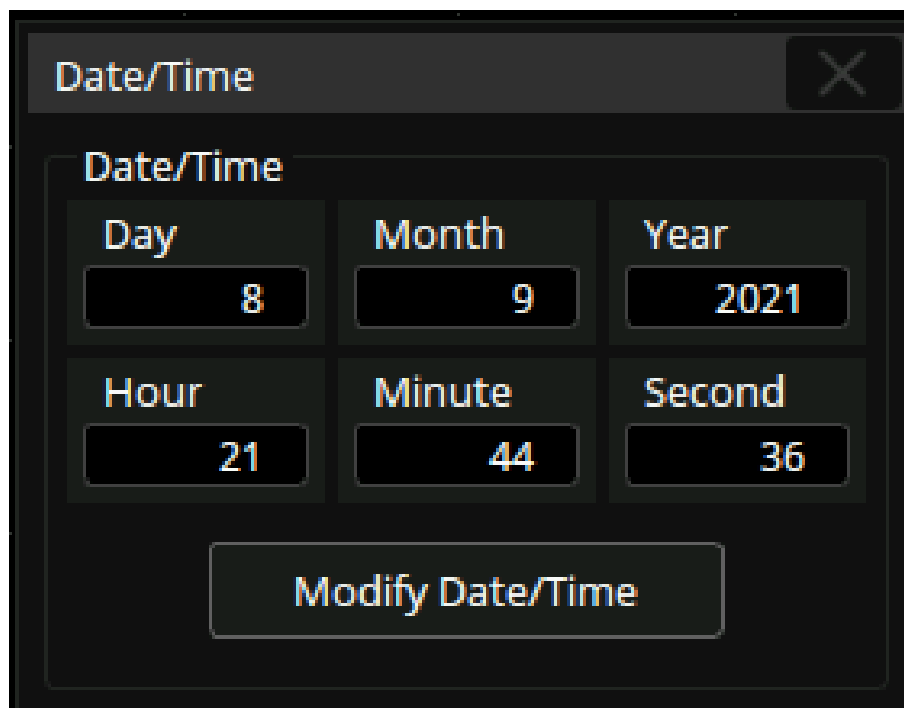

Figure 23.4 Date/Time

23.5 Options

The 2560B series provides a few options to enhance its functionality. Contact your local BK Precision sales representative or BK Precision's technical support to get the corresponding option key. To view the **Options** window shown in figure e23.5:

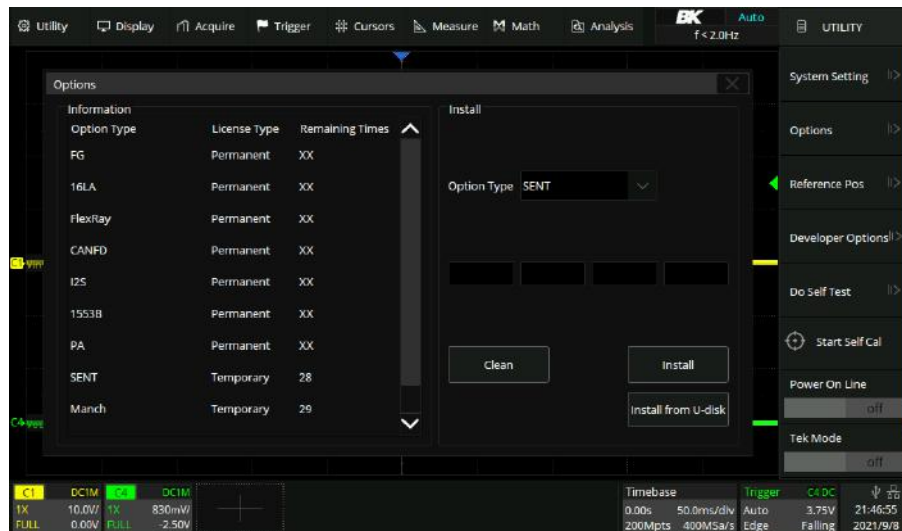

Figure 23.5 Options Window

23.6 Reference Position

The reference position setting determines the physical point that the oscilloscope uses during vertical and horizontal scale changes. In some situations, it is more convenient to use a fixed position on the display.

1. Press the **Utility** key on the front panel and touch **Reference Pos.** to enter the Reference POS menu.
2. Touch **Vertical Ref** to select **Offset** or **Position**.
 - **Position**: when the vertical gain is changed, the oscilloscope will keep the vertical offset level indicator stationary.
 - **offset**: when the vertical gain is changed, the oscilloscope will have the vertical offset level indicator move with the actual voltage level.
3. Press the **Horizontal** softkey to select **Delay** or **Position**.
 - **Position**: when the timebase is changed, the oscilloscope will keep the horizontal offset indicator stationary.
 - **Delay**: when the timebase is changed, the oscilloscope will have the horizontal offset indicator move with the trigger point.

23.7 Do Self-Test

Self-test includes a screen test, keyboard test, and LED test.

23.7.1 Screen Test

1. Press the **Utility** key on the front panel to enter the Utility menu.
2. Touch **Do Self Test** to enter the Self test menu.
3. Press the **Screen Test** softkey to enter the screen test interface, as shown in figure **23.6**



Figure 23.6 Screen Test

4. Press the **Single** key on the front panel continually as it says in the picture above. The screen displays green, blue and red again. It is easy to check chromatic aberration, stain and scratch of the screen under the condition.
5. Press the **Run/Stop** key on the front panel to exit the screen test program.

23.7.2 Keyboard Test

Keyboard test is used to test the keys and knobs. **To perform a keyboard test:**

1. Press the **Utility** key on the front panel to enter the Utility menu.
2. Touch **Do Self Test** to enter the Self test menu.
3. Touch **Keyboard Test** to enter the keyboard test interface, as the picture shown below.

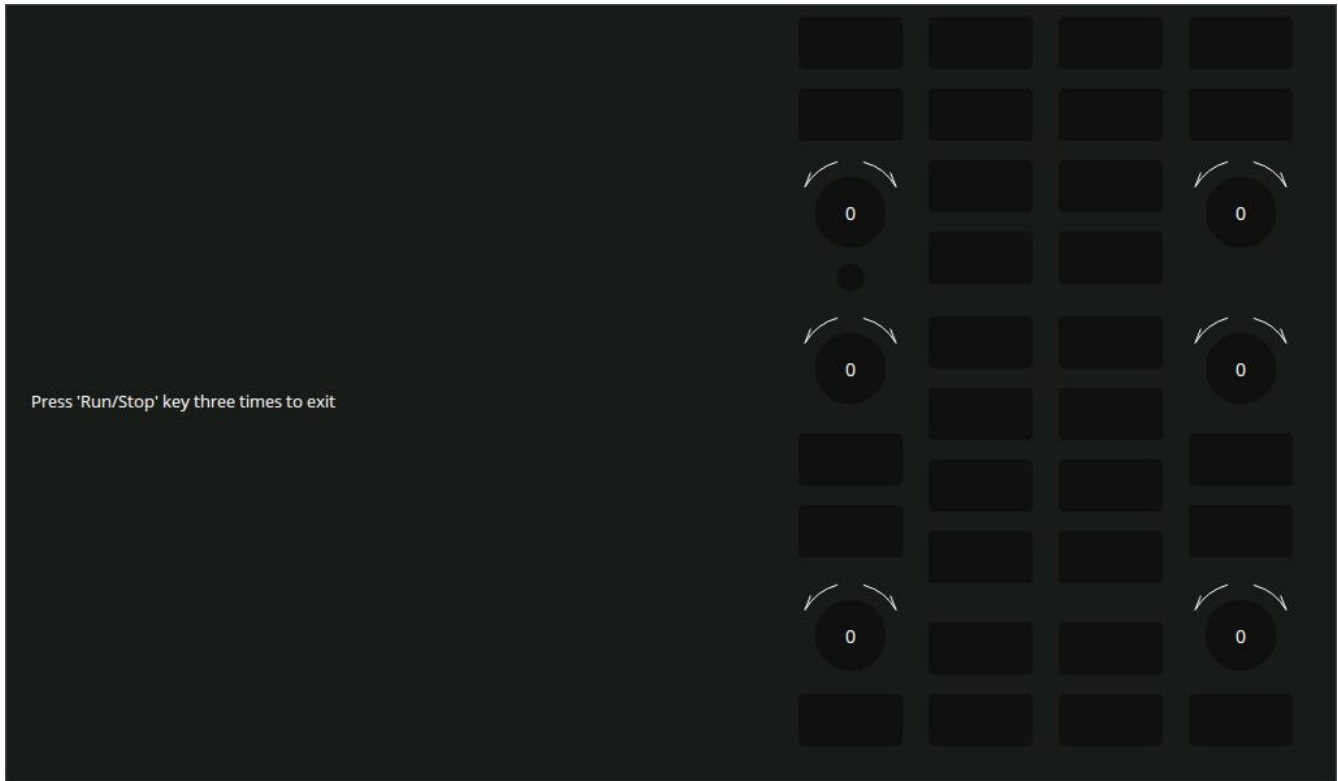

Figure 23.7 Keyboard Test

4. To perform the knobs and the keys test.
 - **Knobs test:** The default value is 0. Turn left to increase the value while turn right to decrease; push the knob to set the value to 0. Test every knob randomly.
 - **Keys test:** The first time to press the key to light it up, and a second press to die out. Test every key randomly.
5. Press the Run/Stop key 3 times to exit the keyboard test program.

23.7.3 LED Test

LED test is used to test the LEDs.

1. Press the **Utility** key on the front panel to enter the Utility menu.
2. Touch **Do Self Test** to enter the Self test menu.
3. Press the **LED Test** softkey to enter the keyboard test interface, as the picture shown below.

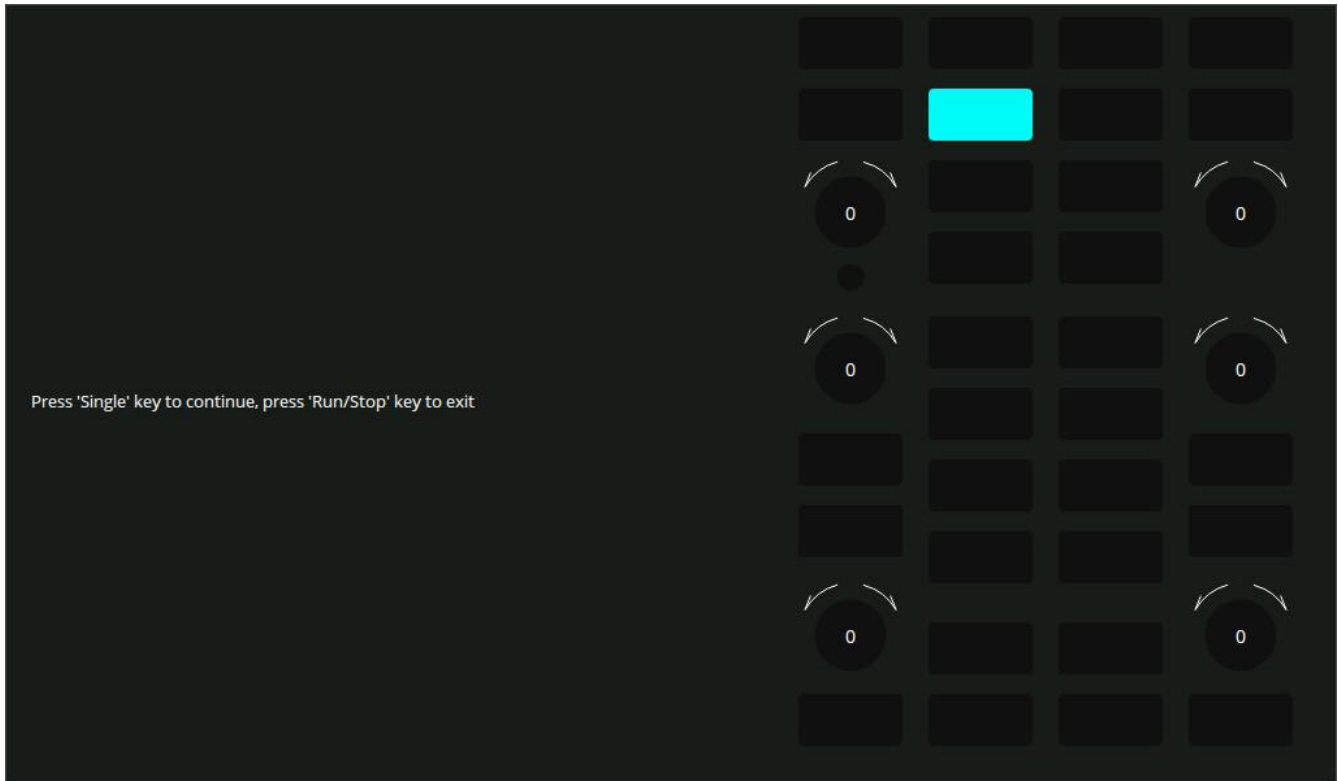

Figure 23.8 LED Test

4. According to the prompting information displaying on the screen, press the **Single** key continually to light the key lights one by one. The first time to press the **Single** key, the **Run/Stop** key displays red, and the second press the **Run/Stop** key displays green. Then the other key lights will be lighted one by one. At last all the lights will be lighted at the same time.
5. Press the **Run/Stop** key to exit the LED test program

23.8 Start Self Cal

The self-calibration program can quickly calibrate the oscilloscope to reach the best working state and the most precise measurement. It is recommended to perform a self-calibration if the change of ambient temperature is more than 5 °C.

Note:

Make sure the oscilloscope has been warmed up or operated for more than 30 minutes before the self-calibration.

To perform a self-calibration :

1. Disconnect all inputs.
2. Press the **Utility** key on the front panel to enter the Utility menu.
3. Touch **Start Self Cal** and it will pop up the following dialog. Select Continue to start the self-cal program.
4. The oscilloscope will not respond to any operation until the self-cal is finished. After the self-cal is completed, touch the screen or press any button to exit.

23.9 Power On Line

To set the power on line:

1. Press the **Utility** key on the front panel.
2. Press the **Power On Line** softkey to select **Enable** or **Disable**.
 - *Enable*: when the oscilloscope is energized, the oscilloscope will start automatically by itself.
 - *Disable*: when the oscilloscope is energized; then; press the power key at the lower-left corner of the front panel to start the oscilloscope.

Remote Control

The 2560b series provides a LAN port and a USB Device port which can be used for remote control in multiple ways.

24.1 Web Browser

A built-in web server provides an approach to control the oscilloscope by a web browser. It doesn't require any additional software to be installed on the controlling computer. Set the LAN port correctly (see section **LAN** for details), input the IP address of the oscilloscope in the browser address bar, and then the user can browse and control the oscilloscope in the web.

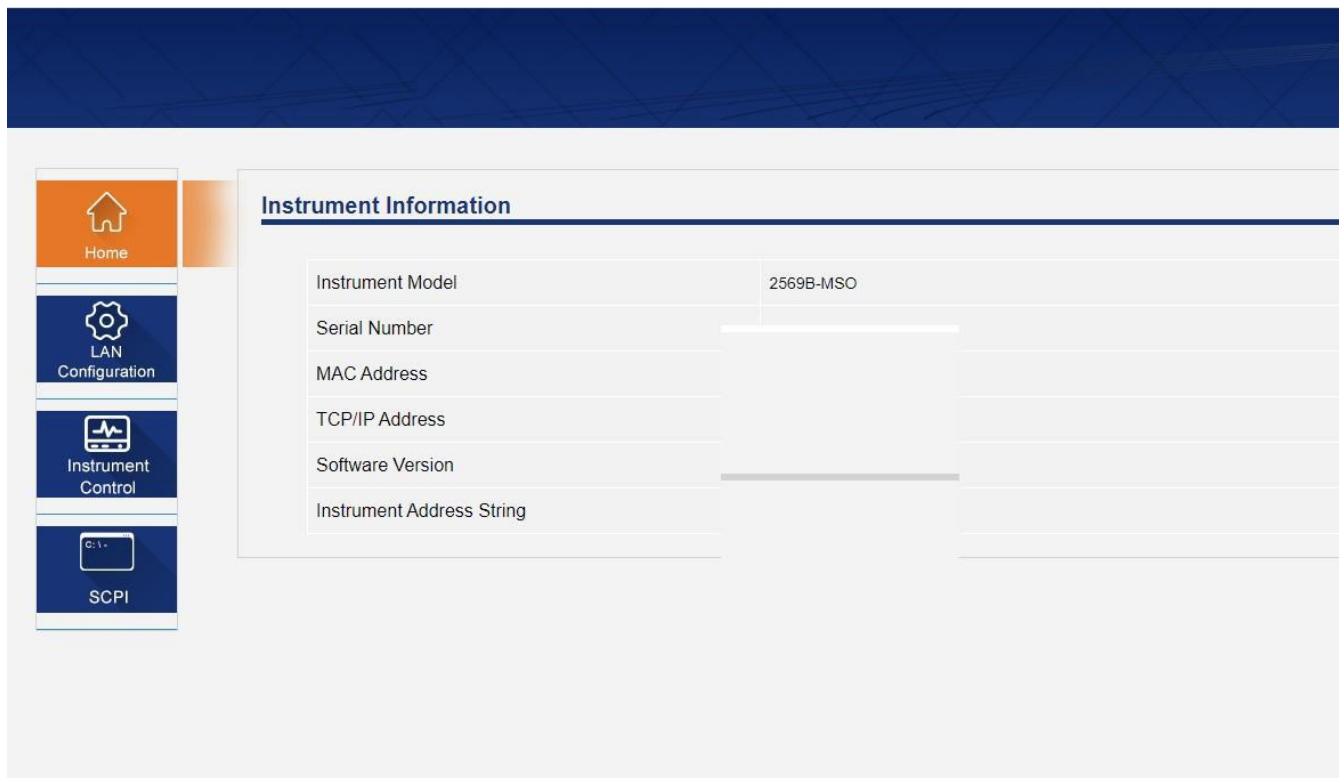

Figure 24.1 Web Server

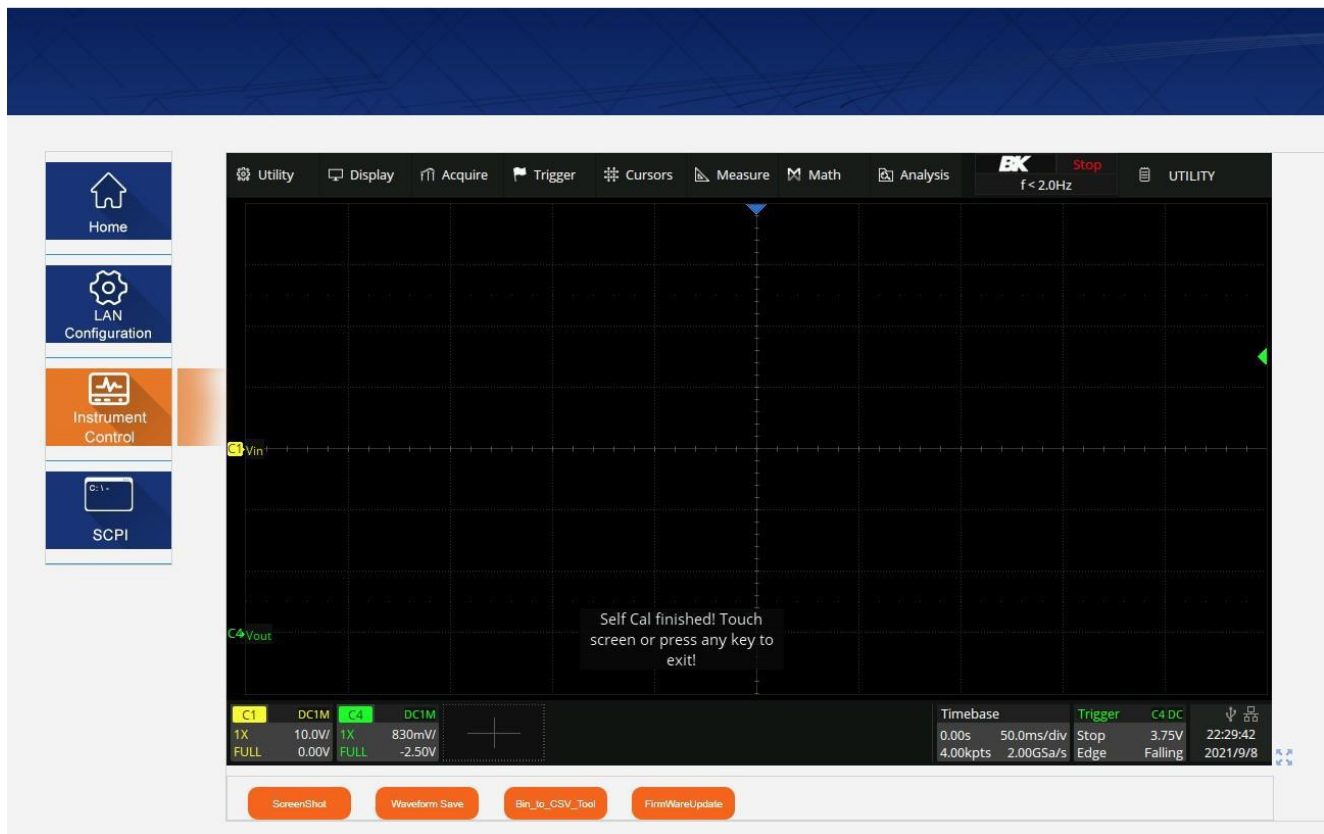

Figure 24.2 Interface

24.2 Other Connectivity

The 2560B series also supports remote control of the instrument by sending SCPI commands via NI-VISA, Telnet, or Socket. For more information, refer to the programming guide of this product.

Troubleshooting

The commonly encountered failures and their solutions are listed below. When you encounter those problems, please solve them following the corresponding steps. If the problem remains still, please contact BK Precision.

The screen is still dark (no display) after power on

1. Check whether the power is correctly connected.
2. Check whether the power switch is really on.
3. Check whether the fuse is burned out. If the fuse needs to be changed, please use the specified fuse.
4. Restart the instrument after finishing the above inspections.
5. If it still does not work correctly, please contact BK Precision.

The signal is sampled but no waveform of the signal is displayed

1. Check whether the probe is correctly connected to the signal connecting wire.
2. Check whether the signal connecting wire is correctly connected to the BNC (namely channel connector).
3. Check whether the probe is correctly connected to the item to be tested.
4. Check whether there are signals generated from the item to be tested (you can connect the probe compensation signal to the problematic channel to determine which has problem, the channel or the item to be tested).
5. Resample the signal.

The tested voltage amplitude is greater or lower than the actual value

Check whether the attenuation coefficient of the channel complies with the attenuation ratio of the probe.

Note:

This problem usually occurs when probe is used.

There is waveform display but not stable

1. Check the trigger signal source: check whether the **Source** item at the trigger panel complies with the signal channel actually used.
2. Check the trigger type: general signals should use "Edge" trigger and video signal should use "Video" trigger. Only when the proper trigger type is used, can the waveform be displayed stably.
3. Change the trigger holdoff setting.

No display after pressing Run/Stop

Check whether the mode at the trigger panel (TRIGGER) is on "Normal" or "Single" and whether the trigger level exceeds the waveform range. If yes, set the trigger level to the middle or set the mode to "Auto".

Note:

Using AUTO could automatically finish the above setting.

The display of waveform is ladder-like

1. The horizontal time base might be too low. Increase the horizontal time base to increase the horizontal resolution and improve the display.
2. If the display **Type** is "Vectors", the lines between the sample points may cause ladder-like display. Set **Type** to "Dots" to solve the problem.

Fail to connect PC through USB

Check the **IO Setting** in **Utility** to make sure whether the setting in **USB Device** matches the device currently connected. If needed, restart the oscilloscope.

The USB storage device cannot be recognized

1. Check whether the USB storage device can work normally.
2. Make sure whether the USB interface can work normally.
3. Make sure that the USB storage device being used is flash storage type. This oscilloscope does not support hardware storage type.
4. Restart the instrument and then insert the USB storage device to check it.
5. If the USB storage device still cannot be used normally, please contact BK Precision.

Service Information

Warranty Service: Please go to the support and service section on our website at bkprecision.com to obtain an RMA #. Return the product in the original packaging with proof of purchase to the address below. Clearly state on the RMA the performance problem and return any leads, probes, connectors and accessories that you are using with the device.

Non-Warranty Service: Please go to the support and service section on our website at bkprecision.com to obtain an RMA #. Return the product in the original packaging to the address below. Clearly state on the RMA the performance problem and return any leads, probes, connectors and accessories that you are using with the device. Customers not on an open account must include payment in the form of a money order or credit card. For the most current repair charges please refer to the service and support section on our website.

Return all merchandise to B&K Precision Corp. with prepaid shipping. The flat-rate repair charge for Non-Warranty Service does not include return shipping. Return shipping to locations in North America is included for Warranty Service. For overnight shipments and non-North American shipping fees please contact B&K Precision Corp.

Include with the returned instrument your complete return shipping address, contact name, phone number and description of problem.

B&K Precision Corp.
22820 Savi Ranch Parkway
Yorba Linda, CA 92887
bkprecision.com
714-921-9095

LIMITED THREE-YEAR WARRANTY

B&K Precision Corp. warrants to the original purchaser that its products and the component parts thereof, will be free from defects in workmanship and materials for a period of **three years** from date of purchase.

B&K Precision Corp. will, without charge, repair or replace, at its option, defective product or component parts. Returned product must be accompanied by proof of the purchase date in the form of a sales receipt.

To help us better serve you, please complete the warranty registration for your new instrument via our website www.bk-precision.com

Exclusions: This warranty does not apply in the event of misuse or abuse of the product or as a result of unauthorized alterations or repairs. The warranty is void if the serial number is altered, defaced or removed.

B&K Precision Corp. shall not be liable for any consequential damages, including without limitation damages resulting from loss of use. Some states do not allow limitations of incidental or consequential damages. So, the above limitation or exclusion may not apply to you.

This warranty gives you specific rights and you may have other rights, which vary from state-to-state.

B&K Precision Corp.
22820 Savi Ranch Parkway
Yorba Linda, CA 92887
www.bkprecision.com
714-921-9095