

Reference Manual

Digital Temperature Indicator

JOFRA DTI050 A/B

© Copyright 2006 AMETEK Calibration Instruments



About this manual....

- **The structure of the manual**

This reference manual is aimed at users who are familiar with AMETEK indicators, as well as those who are not. The manual is divided into 10 chapters, which describe how to set up, operate, service and maintain the indicator. The technical specifications are described and accessories may be ordered from the list of accessories.

- **Safety symbols**

This manual contains a number of safety symbols designed to draw your attention to instructions, which must be followed when using the indicator, as well as any risks involved.



Warning

Events, which may compromise the safe use of the indicator and result in considerable personal or material damage.



Caution...

Events, which may compromise the safe use of the indicator and result in slight personal or material damage.



Note...

Special situations, which demand the user's attention.

List of contents

1.0	Introduction	5
2.0	Safety instructions	7
3.0	Receiving the DTI050	10
3.1	DTI050 interface	12
3.2	DTI050 display	14
3.2.1	Configuration modes	15
3.2.1.1	Setting DTI050 configurations	15
3.2.1.2	Viewing the transducer electronic datasheet (TEDS)	17
4.0	Measuring temperature.....	20
4.1	Measuring temperature with non-intelligent sensors	20
4.2	Measuring temperature with intelligent sensors	22
4.3	Measuring Ohms.....	22
4.4	Measuring mV	22
5.0	Remote operation.....	23
5.1	Remote interface.....	23
5.2	Setting up the RS232 port for remote control	23
5.3	Changing between remote and local operation	24
5.4	Using commands	25
5.4.1	Command types	25
5.4.2	Character processing	26
5.4.3	Response data types.....	26
5.4.4	Indicator status	27
5.5	Remote commands and error codes	27
5.6	Entering commands	30
5.6.1	Common commands	30
5.6.2	DTI050 commands	31
6.0	Programming intelligent sensors	35
7.0	Adjustment procedure	36
	Pin numbering.....	36
7.1	Setting up the RS232 port for remote control	37
7.2	Adjustment.....	38
7.2.1	Equipment	38
7.2.2	Adjustment procedure	38
7.2.2.1	Setting up for adjustment.....	38
7.2.2.2	Adjustment 0-78 mV range	38

7.2.2.3	Adjustment 400 ohm range.....	39
7.2.2.4	Adjustment 4000 ohm range.....	39
7.2.2.5	Adjustment CJC ohm range.....	40
7.2.2.6	Adjustment 500000 ohm range.....	40
8.0	Maintenance.....	41
8.1	Replacing batteries	41
8.2	Cleaning the indicator	41
8.3	Service center calibration or repair	42
9.0	General specifications	44
10.0	List of accessories	51

1.0 Introduction

Congratulations on your new AMETEK JOFRA Digital Temperature Indicator!

With the AMETEK Jofra indicator, you have chosen an extremely effective reference instrument, which we hope will perform according to your expectations. During the past several years, we have acquired extensive knowledge of industrial temperature calibration. This expertise is reflected in our products, which are all designed for daily use in an industrial environment. Please note that we would be very interested in hearing from you if you have any ideas or suggestions for changes to our products.

This reference manual applies to the following indicator:

- **Jofra DT1050**

 **ISO-9001 certified**



Ametek Denmark A/S was ISO-9001 certified in September 1994 by BVQI - Bureau Veritas Quality International.

 **CE-label**



Your new indicator is CE labelled and complies with the EMC directive.

 **Technical assistance**

Please contact the dealer from whom you acquired the indicator if you require technical assistance.

 **Warranty**

According to current terms of sale and delivery.

This warranty only covers defects in material and manufacture and becomes void if the indicator has been subject to unauthorised service/repair and/or misuse.

 **Contacting AMETEK**

US, Canada, Latin America : AMETEK TCI at 1-800-527-9999

Europe, Africa, Middle East : AMETEK Denmark A/S at
+ 45 4816 8000

Asia : AMETEK Singapore Pte. Ltd. at
+ 65 (64) 842 388

The product is manufactured by:

AMETEK DENMARK A/S
GYDEVANG 32 - 34
DK-3450 ALLERØD
DENMARK
TEL.: +45 48 16 80 00
FAX: +45 48 16 80 80

2.0 Safety instructions



Read this manual carefully before using the indicator!

Please follow the instructions and procedures described in this manual. They are aimed at allowing you to make the best of your DTI-system and avoid any personal injuries and/or damage to the indicator.



Disposal – WEEE Directive

The indicator contains electrical and electronic circuits and must be properly recycled or disposed of (in accordance with the WEEE Directive 2002/96/EC).



Warning

The indicator has been designed to calibrate and measure low voltage signals. To ensure the safety of the operator and the indicator, **DO NOT** connect the indicator to input voltages above 30 Volts.

To avoid possible electric shock or personal injury:

- The indicator **must not** be used for any purposes other than those described in this manual.
- **Do not** operate the indicator in environments of explosive gas, vapour, or dust.
- **Do not** apply more than the rated voltage. See specifications for supported ranges.
- Select the proper function and range for your measurement.
- **Do not** use the indicator if it operates abnormally. Protection may be impaired. When in doubt, get the indicator serviced.

- During set-up, make sure that there is correlation between the software set-up, and the actual sensors connected to the DTI050.
- When servicing the indicator, only use specified replacement parts.
- **Do not** use the indicator if it is damaged. Before you use the indicator, inspect the case. Look for cracks or missing plastic.
- Make sure the battery cover is closed before you operate the indicator.
- To avoid false readings, which could lead to possible personal injury, replace the battery as soon as the battery indicator appears.
- To avoid personal injury or damage to the indicator, use only the specified replacement parts. Do not allow water into the case.



Caution...

To avoid possible damage to the indicator or to the equipment under test:

- Disconnect the power and discharge all high-voltage capacitors before testing resistance.
- Use the proper jacks, connectors, function and range for your measurement.
- To avoid damaging the plastic display and case, do not use solvents or abrasive cleansers when cleaning the indicator.



Note...

The product liability **only** applies if the indicator is subject to a manufacturing defect. This liability becomes void if the user fails to follow the maintenance instructions described in this manual or uses unauthorised spare parts.

3.0 Receiving the DTI050

When you receive the indicator...

- Unpack and check the indicator and the accessories carefully.
- Check the parts according to the list shown below.

If any of the parts are missing or damaged, please contact the dealer who sold you the indicator.

You should receive:

- 1 DTI050
-

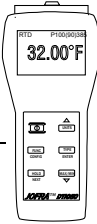

- 1 traceable certificate
-

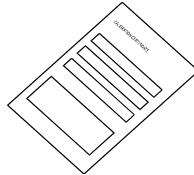

- 1 reference manual
-

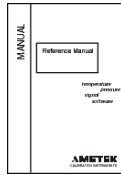

- 1 soft case and shoulder strap
-

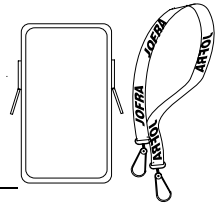

- 1 RS 232 serial cable
-

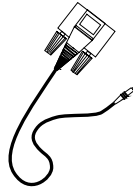

- 1 9V battery
-

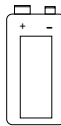

- 1 CD-ROM containing the software package "JOFRACAL".

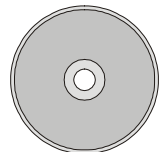

- 1 CD-ROM containing the configuration software package “CON050”.

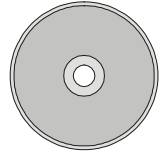

When reordering, please specify the part numbers according to the list of accessories, section. 10.0

3.1 DTI050 interface

Figure 1 shows the location of the indicator features and the table describes their use.

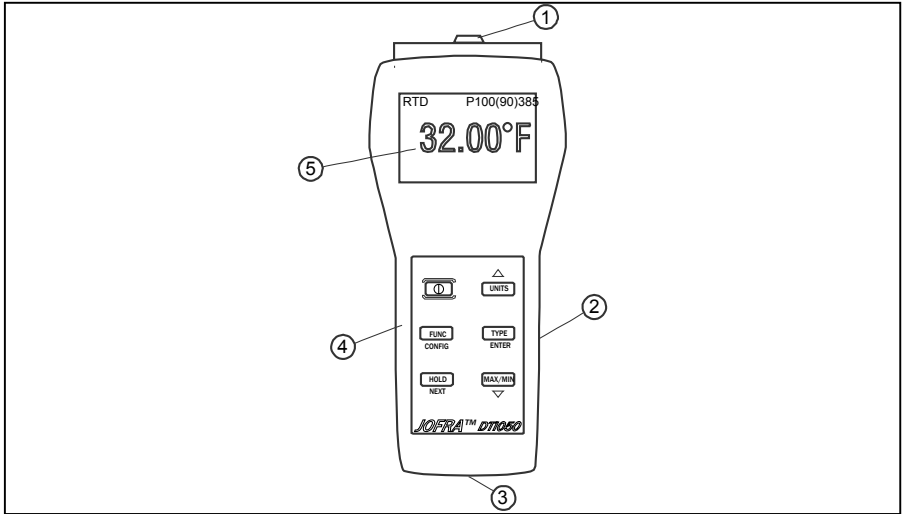

Fig. 1

Pos.	Name	Description
①	Temperature Sensor Connector	This connector is used for connecting temperature sensors to the DTI050.
②	Serial Interface	This is used to interface to a computer or other devices.
③	Power inlet	This is the connection for the mains adapter.
④	Keypad	Used to control the DTI050.
⑤	Display	Used to display temperature readings and other information.

Figure 2 shows the location of the keys, while the table describes the function of each key.

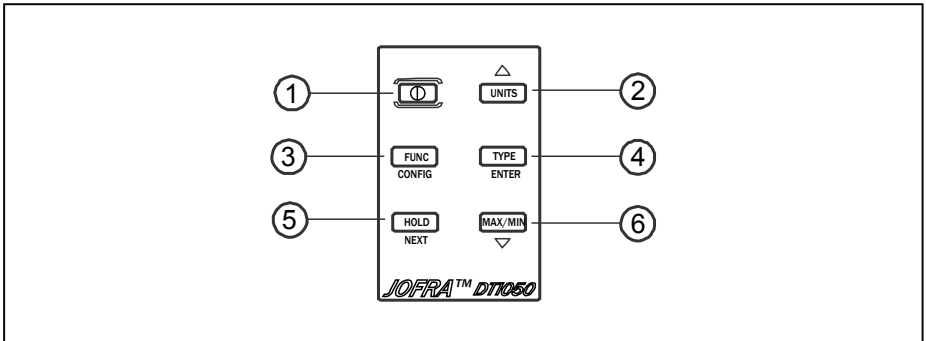

Fig. 2

Pos.	Name	Description
①	ON/OFF Key	This key is used to turn the indicator on and off.
②	UNITS Key	This key is used to change temperature units. This key has a secondary function as a (up arrow) when setting configurations.
③	FUNC Key	This key is used to change functions from TC to mV etc. This key has a second function (CONFIG) used to set DT1050 configurations and verify sensor settings.
④	TYPE Key	This key is for non-intelligent sensors to change the TC type or RTD type. This key has a secondary function as the (ENTER) key when setting configurations.
⑤	HOLD Key	This key is used to freeze the reading of the display. The key has a secondary function as the (NEXT) key when setting configurations.

⑥

MAX/MIN Key

This key is used to display the minimum and maximum value since the function was entered or the min/max register was reset. Hold this key for 3 seconds to reset the min/max register. This key has a secondary function as a (down arrow) key when setting configurations.

3.2 DTI050 display

The main display consists of the following elements depicted below:

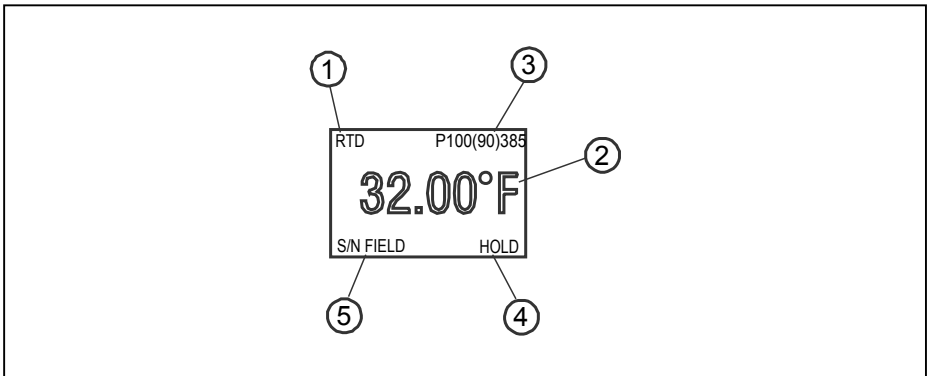

Fig. 3

Pos.	Name	Description
①	Primary Parameters	Indicates the type of sensor being measured.
②	Units	Indicates the unit of measure for the display.
③	Type	Indicates the TC, RTD or Thermistor type being measured (non-intelligent sensors).
④	Display Status	Indicates the status of the display if it is not live, eg. HOLD, MIN, MAX etc.

⑤

Sensor Serial
Number

This displays the serial number for intelligent sensors when they are connected and recognized.

3.2.1 Configuration modes

To enter configuration mode, hold the FUNC (CONFIG) key for 3 seconds. Use the arrow keys to make selections and the NEXT/HOLD key to proceed to the next configuration display.

3.2.1.1 Setting DTI050 configurations

Setting auto shutdown

Use the arrow keys to set the auto shutdown from 1 to 30 minutes.

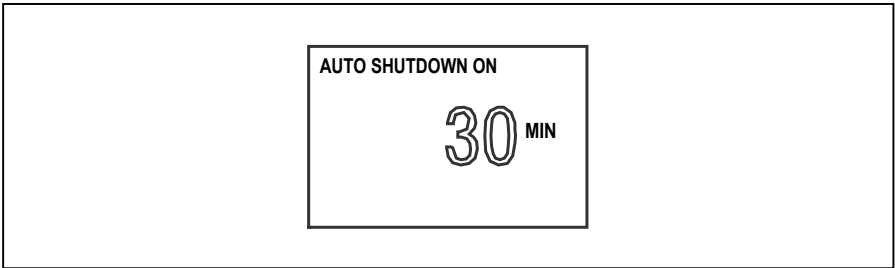

Fig. 4

To turn the auto shutdown off, repeatedly press the down arrow until the display looks as depicted below.

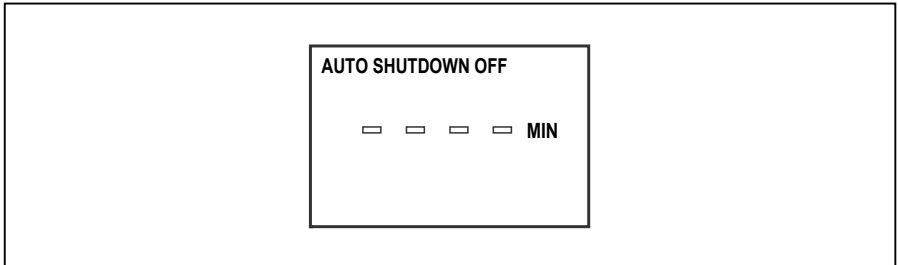

Fig. 5

Setting resolution

Use the arrow keys to adjust the resolution used for temperature readings. When you press the up arrow, the number of zeros to the right of the decimal point will increase to a maximum of three.

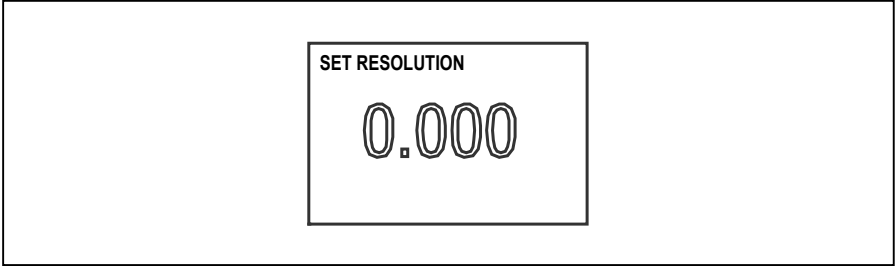

Fig. 6

Setting display contrast

Use the arrow keys to set the display to the desired contrast.

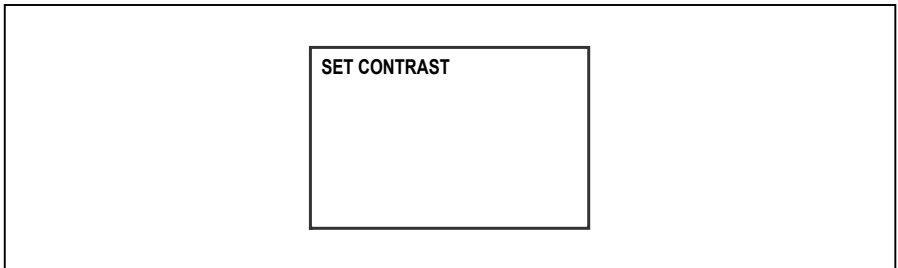

Fig. 7

Setting CJC state

Use the arrow keys to turn cold junction compensation on or off in thermocouple mode.

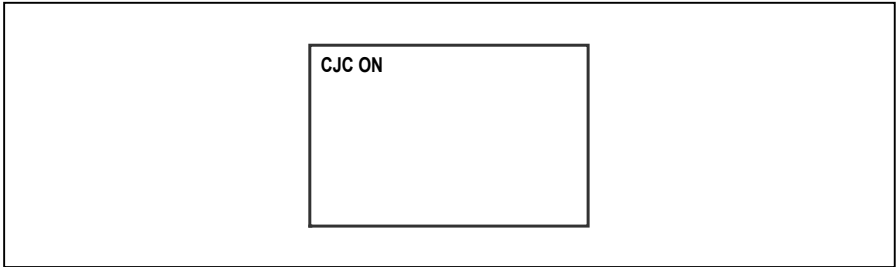

Fig. 8

3.2.1.2 Viewing the transducer electronic datasheet (TEDS)

The TEDS for a connected sensor can be viewed in a series of screens within the configuration mode. Some data is common to all sensors (General TEDS). Other data is specific to the type of sensor connected. The General TEDS includes the following data:

- Manufacturer ID
- Model number
- Version
- Serial number
- Template

Each of the 3 sensor types (TC, RTD, and Thermistor) have their own TEDS format. Relevant data for each format is displayed with units when practical.

TC

Displayed	Description	Units
MIN TEMP	Minimum temperature	°C
MAX TEMP	Maximum temperature	°C
MIN. OUTPUT	Minimum electrical output	V
MAX. OUTPUT	Maximum electrical output	V
MAP METHOD	Mapping method	-
TC TYPE	Thermocouple type	-
BUILD IN	Build in RTD for CJC	-
R0	Resistance R0	Ω
A	CVD coefficient A	1/C (not displayed)
B	CVD coefficient B	1/C ² (not displayed)
C	CVD coefficient C	1/C ³ (not displayed)
A	TC Correction coefficient A	V(not displayed)
B	TC Correction coefficient B	-
C	TC Correction coefficient C	1/V(not displayed)
TC RES	Thermocouple resistance	Ω
RESP TIME	Sensor response time	S
CAL DATE	Calibration date	-
CAL INITIALS	Calibration initials	-
CAL PERIOD	Calibration period	days
MLID	Measurement location ID	-

RTD

Displayed	Description	Units
MIN TEMP	Minimum temperature	°C
MAX TEMP	Maximum temperature	°C
MIN. OUTPUT	Minimum electrical output	Ω
MAX. OUTPUT	Maximum electrical output	Ω
MAP METHOD	Mapping method	-
R0	Resistance R0	Ω
A	CVD coefficient A	1/C(not displayed)
B	CVD coefficient B	1/C ² (not displayed)
C	CVD coefficient C	1/C ³ (not displayed)
RTPW	Resistance RTPW	Ω
AL	ITS-90 coefficient A(LR)	-
BL	ITS-90 coefficient B(LR)	-
C1L	ITS-90 coefficient C(LR)/C1(LR)	-
C2L	ITS-90 coefficient C2(LR)	-
C3L	ITS-90 coefficient C3(LR)	-
C4L	ITS-90 coefficient C4(LR)	-
C5L	ITS-90 coefficient C5(LR)	-
AH	ITS-90 coefficient A(HR)	-
BH	ITS-90 coefficient B(HR)	-
CH	ITS-90 coefficient C(HR)	-
DH	ITS-90 coefficient D(HR)	-
WH	ITS-90 coefficient W(933.473)	-
RESP TIME	Sensor response time	S
EXI NOM	Excitation current, nom	A
EXI MAX	Excitation current, max	A
SELF HEAT	Self-heating constant	W/°C (not displayed)

RTD, cont.

Displayed	Description	Units
CAL DATE	Calibration date	-
CAL INITIALS	Calibration initials	-
CAL PERIOD	Calibration period	days
MLID	Measurement location ID	-

Thermistors

Displayed	Description	Units
MIN TEMP	Minimum temperature	°C
MAX TEMP	Maximum temperature	°C
MIN. OUTPUT	Minimum electrical output	Ω
MAX. OUTPUT	Maximum electrical output	Ω
MAP METHOD	Mapping method	-
R0	Resistance R0	Ω
A	Steinhart-Hart coefficient A	1/C(not displayed)
B	Steinhart-Hart coefficient B	1/C(not displayed)
C	Steinhart-Hart coefficient C	1/C(not displayed)
RESP TIME	Sensor response time	S
EXI NOM	Excitation current, nom	A
EXI MAX	Excitation current, max	A
SELF HEAT	Self-heating constant	W/°C(not displayed)
CAL DATE	Calibration date	-
CAL INITIALS	Calibration initials	-
CAL PERIOD	Calibration period	days
MLID	Measurement location ID	-

4.0 Measuring temperature

4.1 Measuring temperature with non-intelligent sensors

The DTI050 supports measuring temperature with non-intelligent TC, RTD and Thermistor sensors. Table 1 lists the available thermocouple types while table 2 lists the available RTD types.

Table 1; Built in TC curves

TC_type
B
C
E
J
K
L
N
R
S
T
U
BP
XK

Table 2: Built in RTD curves

RTD
P10(90)385
P50(90)385
P100(90)385
P200(90)385
P400(90)385
P500(90)385
P1K(90)385
P50(90)391
P100(90)391
P100(90)392
M10(90)427
M50(90)428
M100(90)428
H120(90)672
P100(90)JIS

Use the FUNC key to pick the type of sensor you wish to measure with (TC, RTD or Thermistor).

For thermocouple sensors the TYPE key can be used to select the sensor's TC type. Cold junction compensation (CJC) can be turned on or off depending on whether the sensor is equipped with built in compensation or you wish to provide it externally.

For RTD sensors the TYPE key can be used to select the sensor's RTD type.

For non-intelligent Thermistor sensors only YSI-400 is available.



Note...

Make sure to allow proper settling time for thermocouples before taking readings.

4.2 Measuring temperature with intelligent sensors

For intelligent sensors simply plug the sensor into the DTI050 and it will automatically detect the sensor and display it's serial number on the screen. All of the sensors parameters can be reviewed in the configuration modes (see section 3.2.1).

For thermocouple sensors CJC can be turned on or off if the sensor has a built in CJC sensor.



Note...

Make sure to allow proper settling time for thermocouples before taking readings.

4.3 Measuring Ohms

The resistance of RTD and Thermistor sensors can be measured in ohms by selecting ohms with the FUNC key. When an intelligent sensor is connected, ohms will only be available for RTD and Thermistor type sensor.

4.4 Measuring mV

The mV output of TC sensors can be measured by selecting mV with the FUNC key. When an intelligent sensor is connected, mV will only be available for TC type sensors.



Note...

Make sure to allow proper settling time for thermocouples before taking readings.

5.0 Remote operation

5.1 Remote interface

The DTI050 can be remotely controlled using a PC terminal, or by a computer program running the indicator in an automated system. It uses an RS232 serial port connection for remote operation. With this connection the user can write programs on the PC with Windows languages like Visual Basic to operate the indicator, or use a Windows terminal program, such as Hyper Terminal, to enter single commands.

5.2 Setting up the RS232 port for remote control



Note...

The RS232 connection cable should not exceed 15m unless the load capacitance measured at connection points is less than 2500pF.

Serial parameter values:

- 9600 baud
- 8 data bits
- no parity
- 1 stop bit
- Xon/Xoff

To set up remote operation of the indicator on the Windows Hyper Terminal, connect the indicator to a COM port on the PC and use the following procedure:

1. Start Hyper Terminal (located in Accessories/Communications of the Windows Start menu)
2. Select New Connection.
3. For Name enter DTI050. Select the serial port that the indicator is connected to.

4. Enter the above information for port settings.
5. Select ASCII setup from File/Properties/Settings and mark these choices:
 - Echo typed characters locally
 - Wrap lines that exceed terminal width
6. Select Ok
7. To see if the port works enter *IDN?. This command will return information on the DTI050.

5.3 Changing between remote and local operation

There are three modes of operation of the indicator, Local, Remote, and Remote with Lockout. Local mode is the default mode. Commands may be entered using the keypad on the indicator or using a computer. In Remote mode the keypad is disabled, and commands may only be entered using a computer, but choosing [GO TO LOCAL] from the menu on the indicator display will restore keypad operation. In Remote with Lockout, the keypad can not be used at all. To switch modes proceed as follows:

1. To enable Remote mode, type in the serial command REMOTE at the computer terminal.
2. To enable Remote with Lockout, type in "REMOTE" and "LOCKOUT" in either order.
3. To switch back to local operation enter LOCAL at the terminal. This command also turns off Lockout, if it was on. For more information on commands refer to the Remote commands section.

5.4 Using commands

5.4.1 Command types

Refer to the section on Remote commands for all available commands.

The indicator may be controlled using commands and queries. All commands may be entered using upper or lower case. The commands are divided into the following categories:

Indicator commands

Only the indicator uses these commands. For example

VAL?

asks for the values displayed on the indicator display.

Common commands

Standard commands used by most devices. These commands always begin with an "*". For example

*IDN?

tells the indicator to return its identification.

Query commands

Commands that ask for information, they always end with a "?". For example:

FUNC?

Returns the current modes of the indicator displays.

Compound commands

Commands that contain more than one command on one line. For example;

RTD_TYPE PT385_100;RTD_TYPE?

Sets the indicator to RTD type PT385_100 and queries it to verify. It will return:

PT385_100

5.4.2 Character processing

The data entered into the indicator is processed as follows:

ASCII characters are discarded if their decimal equivalent is less than 32 (space), except 10 (LF) and 13 (CR):

- Data is taken as 7-bit ASCII.
- The most significant data bit is ignored.
- Upper or lower case is acceptable.

5.4.3 Response data types

The data returned by the indicator can be divided into four types:

Integer

For most computers and controllers they are decimal numbers ranging from -32768 to 32768. For example:

FAULT? could return 110

Refer to the Error codes table for more information on error codes.

Floating

Floating numbers have up to 15 significant figures and exponents. For example:

P_CVD_A? returns 3.908300E-03

Character response data (CRD)

Data returned as keywords. For example:

RTD_TYPE? returns PT385_100

Indefinite ASCII (IAD)

Any ASCII characters followed by a terminator. For example:

*IDN? returns AMETEK, DTI050, 1234567, 1.00

5.4.4 Indicator status

Error queue

If an error occurs due to invalid input or buffer overflow, its error code is sent to the error queue. The error code can be read from the queue with the command FAULT?. The error queue holds 15 error codes. When it is empty, FAULT? returns 0. The error queue is cleared when power is reset or when the clear command *CLS is entered.

Input buffer

Indicator stores all received data in the input buffer. The buffer holds 250 characters. The characters are processed on a first in, first out basis.

5.5 Remote commands and error codes

The following tables list all commands, and their descriptions, that are accepted by the indicator.

Common commands (table 3)

Command	Description
*CLS	(Clear status.) Clears the error queue.
*IDN?	Identification query. Returns the manufacturer, model number, and firmware revision level of the indicator.
*RST	Resets the indicator to the power up state.

DTI050 commands (table 4)

Command	Description
FAULT?	Returns a fault code.
FUNC	Sets the measurement function of the DTI050.
FUNC?	Returns the state of the measurement function of the DTI050.
LOCAL	Sets the DTI050 to local operation.

DTI050 commands, cont.

Command	Description
LOCKOUT	Locks out the keypad when the DTI050 is in remote mode.
MV?	Returns the voltage (in mV) that the DTI050 is reading when in TC.
OHMS?	Returns the resistance the DTI050 is reading when in RTD.
REMOTE	Puts the DTI050 in remote.
RTD_TYPE	Sets the RTD type (for non-intelligent sensors).
RTD_TYPE?	Returns the RTD type (for non-intelligent sensors).
TC_TYPE	Sets the TC type (for non-intelligent sensors).
TC_TYPE?	Returns the TC type (for non-intelligent sensors).
TEMP_RES	Sets the display resolution of the DTI050 for temperature read outs.
TEMP_RES?	Returns the display resolution of the DTI050 for temperature read outs.
TEMP_UNIT	Sets the temperature units of the DTI050 for temperature read outs.
TEMP_UNIT?	Returns the temperature units of the DTI050 for temperature read outs.
VAL?	Returns the value of the temperature reading with units.

Parameter units (table 5)

Units	Meaning
A	Current in amperes.
V	Voltage in volts.
Cel	Temperature in Celsius.
Far	Temperature in Fahrenheit.
Kel	Temperature in Kelvin.
Ohm	Resistance in Ohms.
On	Turn something on.
Off	Turn something off.
Sec	Time in seconds .

Error codes (table 6)

Error number	Error description
100	A non-numeric entry was received where it should be a numeric entry.
101	Too many digits entered.
102	Invalid units or parameter value received.
103	Entry is above the upper limit of the allowable range.
104	Entry is below the lower limit of the allowable range.
105	A required command parameter was missing.
106	An invalid command parameter was received.
108	Invalid sensor type.
110	An unknown command was received.
111	Bad parameter received.
112	The serial input buffer overflowed.

Error codes, cont.

Error number	Error description
113	Too many entries in the command line.
114	The serial output buffer overflowed.

5.6 Entering commands

Commands for the DTI050 may be entered in upper or lower case. There is at least one space required between the command and parameter, all other spaces are optional. Almost all commands for the indicator are sequential, any overlapped commands will be indicated as such. This section will briefly explain each of the commands and describe their general use, which will include any parameters that may be entered with the command as well as what the output of the command is.

5.6.1 Common commands

***CLS**

Clears the error queue. Also terminates all pending operations. When writing programs, use before each procedure to avoid buffer overflow.

***IDN?**

Returns the manufacturer, model number, serial number and firmware revision of the Indicator. For example:

*IDN? will return AMETEK,DTI050,0000123,1.00

5.6.2 DTI050 commands

FAULT?

Returns the error code number of an error that has occurred. The command may be entered when the previous command did not do what it was meant to do.

For example, if an invalid command was sent, FAULT? would return:

110 which is the code number for an unknown command being received.

Refer to the Error codes table for more information on error code numbers.

FUNC

Sets the DTI050 to the mode indicated in the argument. The following is a list of valid arguments:

RTD

THERM

OHMS

TC

MV

For example:

To set the DTI050 into RTD mode send FUNC RTD.

FUNC?

Returns the current mode of the DTI050. For example if the DTI050 is set to RTD, FUNC? Would return:

RTD

LOCAL

Restores the DTI050 to local operation if it was in remote mode. Also clears LOCKOUT if the DTI050 was in lockout mode.

LOCKOUT

Sending this command sets the lockout state, when the DTI050 is in REMOTE or goes to remote it prohibits use of the keypad completely. The lockout state can only be cleared by sending the LOCAL command.

MV?

Returns the raw voltage value from a thermocouple.

For example:

If when measuring a type J at 0 degrees cel sending MV? would return 0.000000E+00, MV .

OHMS?

Returns the raw Ohm value from a RTD.

For example:

If when measuring a P100-385 at 0 degrees cel sending OHMS? would return 1.000000E+02, OHM .

REMOTE

Puts the DTI050 in remote mode. From the remote mode the user can still use the keypad to get back to local unless the command LOCKOUT was entered before REMOTE. Then the keypad is totally locked out and the user has to send the LOCAL command to get back to local operation.

RTD_TYPE

Sets the RTD type. The following is a list of RTD types the way they should be entered after the command:

P10(90)385	P50(90)385	P100(90)385
P200(90)385	P400(90)385	P500(90)385
P1K(90)385	P50(90)391	P100(90)391
P100(90)392	M10(90)427	M50(90)428
M100(90)428	H120(90)672	P100(90)JIS

For example:

RTD_TYPE P100(90)385 sets RTD type to PT100, $\alpha=385$, ITS-90

RTD_TYPE?

Returns the RTD type.

For example:

If the RTD type is PT100, $\alpha=385$, ITS-90, RTD_TYPE? Will return P100(90)385.

TC_TYPE

Sets the TC type. The following is a list of TC types the way they should be entered after the command:

B

C

E

J

K

L

N

R

S

T

U

BP

XK

For example:

TC_TYPE J sets the TC type to J

TC_TYPE?

Returns the TC type.

For example:

If the TC type is J, TC_TYPE? Will return J.

TEMP_RES

Sets the resolution for all DTI050 temperature readings.

For example:

TEMP_RES 3 would set the resolution of the temperature display to 1 thousandth.

TEMP_RES?

Returns the number of digits to the right of the decimal point.

For example:

If the resolution is 1 thousandth, TEMP_RES? will return 3.

TEMP_UNIT

This command is used to change the temperature unit used, when measuring temperature.

The argument is the unit, either KEL for Kelvin, CEL for Celsius or FAR for Fahrenheit.

For example:

To set the temperature unit to Fahrenheit on the lower display send TEMP_UNIT, FAR.

TEMP_UNIT?

Returns the temperature unit, (KEL, CEL or FAR) used when measuring RTDs.

VAL?

Returns the value of the measurement taking place on the DTI050. For example, if the DTI050 is measuring 25.010 °C VAL? will return:

2.50100E+01,CEL

6.0 Programming intelligent sensors

Use the configuration software CON050 supplied with DTI050 to program and to update calibration information in intelligent sensors.

For instructions read the software manual for CON050 installed on the CD-ROM.

Latest version of CON050 and the manual can be downloaded form www.jofra.com.

7.0 Adjustment procedure

Pin numbering

The pin-layout is as follows:

- Pin 1 : RTD I-/ CJC Pt1000 -
- Pin 2 : RTD S-/ TC V-
- Pin 3 : RTD S+/ TC V+
- Pin 4 : RTD I+/ CJC Pt1000 +
- Pin 5 : Memory GND
- Pin 6 : Memory I/O

The figure below is shown from the wire side of the sensor connector.

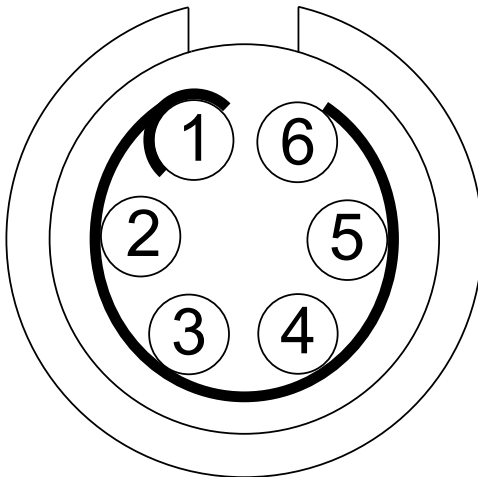

7.1 Setting up the RS232 port for remote control



Note...

The RS232 connection cable should not exceed 15m unless the load capacitance measured at connection points is less than 2500pF.

Serial parameter values:

- 9600 baud
- 8 data bits
- no parity
- 1 stop bit
- Xon/Xoff

To set up remote operation of the indicator on the Windows Hyper Terminal, connect the indicator to a COM port on the PC and use the following procedure:

1. Start Hyper Terminal (located in Accessories/Communications of the Windows Start menu)
2. Select New Connection.
3. For Name enter DTI050. Select the serial port that the indicator is connected to.
4. Enter the above information for port settings.
5. Select ASCII setup from File/Properties/Settings and mark these choices:
 - Echo typed characters locally
 - Wrap lines that exceed terminal width
6. Select Ok
7. To see if the port works enter *IDN?. This command will return information on the DTI050.

7.2 Adjustment

7.2.1 Equipment

Voltage source –10 mV and 75 mV (15 ppm accuracy).
15 ohm reference resistor (10 ppm accuracy).
100 ohm reference resistor (10 ppm accuracy).
400 ohm reference resistor (10 ppm accuracy).
900 ohm reference resistor (10 ppm accuracy).
1100 ohm reference resistor (10 ppm accuracy).
4000 ohm reference resistor (15 ppm accuracy).
300K ohm reference resistor (40 ppm accuracy).
500K ohm reference resistor (40 ppm accuracy).

7.2.2 Adjustment procedure

The following procedure describes the adjustment of DTI050 by use of Windows hyperterminal or similar communication software. Allow 15 min warm up time before start of adjustment.

7.2.2.1 Setting up for adjustment

1. Send command “*RST” to reset the unit
2. Send command “P_UPLOAD_OFF” to disable upload of data from the intelligent sensor/connector.

7.2.2.2 Adjustment 0-78 mV range

1. Connect voltage source to DTI050. Voltage source + terminal are connected to terminal 3 on DTI050 and voltage source – terminal are connected to terminal 2 on DTI050.
2. Wait 5 min. for thermal stabilization
3. Send command “**FUNC MV**”.
4. Send command “**NUM_CALP 2**”.
5. Send command “**REF[0] –10.000**” (Replace 10.000 with actual value.).
6. Send command “**REF[1] 75.000**” (Replace 75.000 with actual value.).
7. Set voltage source to –10mV.
8. Send command “**CAL_POINT[0]**”.

9. Set voltage source to 75mV.
10. Send command "**CAL_POINT[1]**".

7.2.2.3 Adjustment 400 ohm range

1. Connect the reference resistor to terminal 3 (S+), 4 (I+), 2 (S-) and 1 (I-).
2. Send command "**FUNC LO_OHMS**".
3. Send command "**NUM_CALP 3**".
4. Send command "**REF[0] 15.000**". (Replace 15.000 with actual resistor value.)
5. Send command "**REF[1] 100.000**". (Replace 100.000 with actual resistor value.)
6. Send command "**REF[2] 400.000**". (Replace 400.000 with actual resistor value.)
7. Connect 15 ohm reference resistor to DTI050.
8. Send command "**CAL_POINT[0]**".
9. Connect 100 ohm reference resistor to DTI050.
10. Send command "**CAL_POINT[1]**".
11. Connect 400 ohm reference resistor to DTI050.
12. Send command "**CAL_POINT[2]**".

7.2.2.4 Adjustment 4000 ohm range

1. Connect the reference resistor to terminal 3 (S+), 4 (I+), 2 (S-) and 1 (I-).
2. Send command "**FUNC MED_OHMS**".
3. Send command "**NUM_CALP 2**".
4. Send command "**REF[0] 400.000**". (Replace 400.000 with actual resistor value.)
5. Send command "**REF[1] 4000.000**". (Replace 4000.000 with actual resistor value.)
6. Connect 400 ohm reference resistor to DTI050.
7. Send command "**CAL_POINT[0]**".
8. Connect 4000 ohm reference resistor to DTI050.
9. Send command "**CAL_POINT[1]**".

7.2.2.5 Adjustment CJC ohm range

1. Connect the reference resistor to terminal 4 (+) and 1 (-).
2. Send command "**FUNC CJC_OHMS**".
3. Send command "**NUM_CALP 2**".
4. Send command "**REF[0] 900.000**". (Replace 900.000 with actual resistor value.)
5. Send command "**REF[1] 1100.000**". (Replace 1100.000 with actual resistor value.)
6. Connect 900 ohm reference resistor to DTI050.
7. Send command "**CAL_POINT[0]**".
8. Connect 1100 ohm reference resistor to DTI050.
9. Send command "**CAL_POINT[1]**".

7.2.2.6 Adjustment 500000 ohm range

1. Connect the reference resistor to terminal 3 (S+), 4 (I+), 2 (S-) and 1 (I-).
2. Send command "**FUNC HI_OHMS**".
3. Send command "**NUM_CALP 3**".
4. Send command "**REF[0] 100.000**". (Replace 100.000 with actual resistor value.)
5. Send command "**REF[1] 300000.000**". (Replace 300000.000 with actual resistor value.)
6. Send command "**REF[2] 500000.000**". (Replace 500000.000 with actual resistor value.)
7. Connect 15 ohm reference resistor to DTI050.
8. Send command "**CAL_POINT[0]**".
9. Connect 100 ohm reference resistor to DTI050.
10. Send command "**CAL_POINT[1]**".
11. Connect 400 ohm reference resistor to DTI050.
12. Send command "**CAL_POINT[2]**".

8.0 Maintenance

8.1 Replacing batteries

Replace batteries as soon as the battery indicator turns on to avoid false measurements. If the batteries discharge too deeply the DT1050 will automatically shut down to avoid battery leakage.



Note...

Use only AA size alkaline batteries or optional rechargeable battery pack.

8.2 Cleaning the indicator



Warning

To avoid personal injury or damage to the indicator, use only the specified replacement parts and do not allow water into the case.



Caution...

To avoid damaging the plastic display and case, do not use solvents or abrasive cleansers.

Clean the outer surface of the indicator with a soft cloth dampened with water or water and mild detergent.

8.3 Service center calibration or repair

Only qualified service personnel should perform calibration, repairs, or servicing not covered in this manual. If the indicator fails, check the batteries first, and replace them if needed.

Verify that the indicator is being operated as explained in this manual. If the indicator is faulty, please enclose a fully completed service information form. Simply copy the form on the following page and fill in the required information. Be sure to pack the indicator securely, using the original shipping container if it is available.



Note...

If the software detects an error during operation, the error will be shown in the display.

Make a note of the error message and contact your distributor or AMETEK Denmark's service department.

AMETEK Denmark's liability ceases if:

- parts are replaced/repared using spare parts which are not identical to those recommended by the manufacturer.
- non-original parts are used in any way when operating the indicator.

AMETEK Denmark's liability is restricted to errors that originated from the factory.

Service info

Customer data:**Date:**

Customer name and address: _____

Attention and dept.: _____

Fax no./phone no.: _____

Your order no.: _____

Delivery address: _____

Distributor name: _____

Indicator data:

Model and serial no.: _____

Warranty claimed Yes: ___ No: ___ Original invoice no.: _____

Temp.
calibrationSensor
input**Service request:****This indicator is sent for
(please tick off):**

___ Calibration as left

___ Check

___ Calibration as found and as left

___ Service

___ Accredited calibration as left

___ Repair

___ Accredited calibration as found and as left.

Diagnosis data/cause for return:

Diagnosis/fault description: _____

Special requests: _____

Safety precautions: if the product has been exposed to any hazardous substances, it must be thoroughly decontaminated before it is returned to Ametek. Details of the hazardous substances and any precautions to be taken must be enclosed.

9.0 General specifications

Ambient $23^{\circ}\text{C} \pm 3^{\circ}\text{C}$ unless otherwise specified

Resistance specifications (table 7)

Ranges	Absolute uncertainty (tcal $\pm 5^{\circ}\text{C}$) $\pm\%$ reading \pm floor	
	1 year	Resolution
0 – 400 Ohms	$\pm 0.004\% \pm 0.002$ Ohms	0.001
400 – 4000 Ohms	$\pm 0.004\% \pm 0.02$ Ohms	0.01
0 – 200 Kohms	$\pm 0.02\% \pm 2.0$ Ohms	10hm
200Kohms – 500 Kohms	$\pm 0.03\%$	10hm

mVolts specifications (table 8)

Ranges	Absolute uncertainty (tcal $\pm 5^{\circ}\text{C}$) $\pm\%$ reading \pm floor	
	1 year	Resolution
-10 mV – 75 mV	$\pm 0.005\% \pm 5\mu\text{V}$	0.001

TC TYPE	Temperature range °C		Temperature range °F		12 months accuracy excl. CJC	
	Minimum	Maximum	Minimum	Maximum	°C	°F
B	600	800	1112	1472	0.66	1.18
	800	1000	1472	1832	0.64	1.16
	1000	1550	1832	2822	0.65	1.18
	1550	1820	2822	3308	0.67	1.21
C	0	150	32	302	0.25	0.45
	150	650	302	1202	0.24	0.43
	650	1000	1202	1832	0.26	0.47
	1000	1800	1832	3272	0.47	0.85
	1800	2316	3272	4201	0.81	1.46
E	-250	-100	-418	-148	0.47	0.84
	-100	-25	-148	-13	0.10	0.19
	-25	350	-13	662	0.11	0.20
	350	650	662	1202	0.09	0.17
	650	1000	1202	1832	0.12	0.21
J	-210	-100	-346	-148	0.24	0.43
	-100	-30	-148	-22	0.12	0.21
	-30	150	-22	302	0.11	0.20
	150	760	302	1400	0.13	0.23
	760	1200	1400	2192	0.15	0.27
K	-200	-100	-328	-148	0.31	0.56
	-100	-25	-148	-13	0.16	0.28
	-25	120	-13	248	0.14	0.25
	120	1000	248	1832	0.18	0.33
	1000	1372	1832	2502	0.23	0.41
L	-200	-100	-328	-148	0.34	0.61
	-100	800	-148	1472	0.24	0.43
	800	900	1472	1652	0.14	0.25
N	-200	-100	-328	-148	0.48	0.87
	-100	-25	-148	-13	0.23	0.42
	-25	120	-13	248	0.20	0.37
	120	410	248	770	0.19	0.34
	410	1300	770	2372	0.20	0.37

Continued

TC TYPE	Temperature range °C		Temperature range °F		12 months accuracy excl. CJC	
	Minimum	Maximum	Minimum	Maximum	°C	°F
R	0	250	32	482	0.96	1.73
	250	400	482	752	0.55	1.00
	400	1000	752	1832	0.53	0.96
	1000	1767	1832	3213	0.49	0.89
S	0	250	32	482	0.94	1.70
	250	1000	482	1832	0.62	1.12
	1000	1400	1832	2552	0.50	0.89
	1400	1767	2552	3213	0.57	1.03
T	-250	-150	-418	-238	0.74	1.33
	-150	0	-238	32	0.21	0.38
	0	120	32	248	0.14	0.24
	120	400	248	752	0.13	0.23
U	-200	0	-328	32	0.52	0.94
	0	600	32	1112	0.25	0.45
BP	0	200	32	392	0.40	0.72
	200	600	392	1112	0.30	0.54
	600	800	1112	1472	0.38	0.68
	800	1600	1472	2912	0.44	0.79
	1600	2000	2912	3632	0.56	1.01
	2000	2500	3632	4532	0.78	1.40
XK	-200	-100	-328	-148	0.21	0.38
	-100	300	-148	572	0.13	0.23
	300	800	572	1472	0.19	0.34

RTD TYPE	Temp. Range °C		Temp. Range °F		12 months accuracy	
	Minimum	Maximum	Minimum	Maximum	°C	°F
PT385, 10 ohm	-200	-80	-328	-112	0.06	0.10
	-80	0	-112	32	0.06	0.11
	0	100	32	212	0.07	0.12
	100	300	212	572	0.08	0.15
	300	400	572	752	0.09	0.16
	400	630	752	1166	0.10	0.19
	630	800	1166	1472	0.12	0.21
PT385, 50 ohm	-200	-80	-328	-112	0.02	0.03
	-80	0	-112	32	0.03	0.05
	0	100	32	212	0.03	0.05
	100	300	212	572	0.04	0.06
	300	400	572	752	0.04	0.07
	400	630	752	1166	0.05	0.10
	630	800	1166	1472	0.06	0.11
PT385, 100 ohm	-200	-80	-328	-112	0.01	0.02
	-80	100	-112	212	0.02	0.04
	100	300	212	572	0.03	0.05
	300	400	572	752	0.03	0.06
	400	630	752	1166	0.05	0.08
	630	800	1166	1472	0.06	0.10
PT3926, 100 ohm	-200	-80	-328	-112	0.01	0.02
	-80	0	-112	32	0.02	0.03
	0	100	32	212	0.02	0.03
	100	300	212	572	0.03	0.05
	300	400	572	752	0.03	0.06
	400	630	752	1166	0.05	0.08

Continued

RTD TYPE	Temp. Range °C		Temp. Range °F		12 months accuracy	
	Minimum	Maximum	Minimum	Maximum	°C	°F
PT3916, 100 ohm	-200	-190	-328	-310	0.01	0.01
	-190	-80	-310	-112	0.01	0.02
	-80	0	-112	32	0.02	0.03
	0	100	32	212	0.02	0.03
	100	260	212	500	0.03	0.05
	260	300	500	572	0.03	0.05
	300	400	572	752	0.03	0.06
	400	800	752	1472	0.06	0.10
PT3916, 50 ohm	-200	-190	-328	-310	0.01	0.02
	-190	-80	-310	-112	0.02	0.03
	-80	0	-112	32	0.02	0.04
	0	100	32	212	0.02	0.04
	100	260	212	500	0.03	0.06
	260	300	500	572	0.03	0.06
	300	400	572	752	0.04	0.07
	400	800	752	1472	0.06	0.11
PT385, 200 ohm	-200	-80	-328	-112	0.03	0.06
	-80	0	-112	32	0.04	0.06
	0	100	32	212	0.04	0.07
	100	260	212	500	0.04	0.08
	260	300	500	572	0.05	0.10
	300	400	572	752	0.06	0.10
	400	630	752	1166	0.08	0.14
PT385, 400 ohm	-200	-80	-328	-112	0.02	0.03
	-80	0	-112	32	0.03	0.05
	0	100	32	212	0.03	0.06
	100	300	212	572	0.04	0.07
	300	400	572	752	0.04	0.08
	400	630	752	1166	0.06	0.10

Continued

RTD TYPE	Temp. Range °C		Temp. Range °F		12 months accuracy	
	Minimum	Maximum	Minimum	Maximum	°C	°F
PT385, 500 ohm	-200	-80	-328	-112	0.02	0.03
	-80	0	-112	32	0.02	0.04
	0	100	32	212	0.03	0.05
	100	260	212	500	0.03	0.06
	260	300	500	572	0.03	0.06
	300	400	572	752	0.04	0.07
	400	630	752	1166	0.05	0.10
PT385, 1000 ohm	-200	-80	-328	-112	0.01	0.02
	-80	0	-112	32	0.02	0.03
	0	100	32	212	0.02	0.04
	100	260	212	500	0.03	0.05
	260	300	500	572	0.03	0.05
	300	400	572	752	0.03	0.06
	400	630	752	1166	0.05	0.08
NI120 672	-80	260	-112	500	0.01	0.02
NI100 617	-60	179	-76	354.2	0.01	0.02
JIS	-200	-190	-328	-310	0.01	0.01
	-190	-80	-310	-112	0.01	0.02
	-80	0	-112	32	0.02	0.03
	0	100	32	212	0.02	0.04
	100	260	212	500	0.03	0.05
	260	300	500	572	0.03	0.05
	300	400	572	752	0.03	0.06
400	630	752	1166	0.05	0.08	
Cu10 427	-100	260	-148	500	0.07	0.12
Cu50 428	-180	199	-292	390.2	0.03	0.05
Cu100 428	-180	199	-292	390.2	0.02	0.04

General specifications (table 9)

Display	LCD 128X64 Graphical display
Display Resolution	5 digits
Display Update	Approximately 2 times a second
Batteries	1 x 9VDC Alkaline
Low Battery Indicator	at 6V
Temperature performance	for temperatures outside tcal $\pm 5^{\circ}\text{C}$ is 10ppm/ $^{\circ}\text{C}$
EMC	CE: Conforms to EN 61326 Light industry level
Battery Life	minimum 10 hrs
Operating Temperature	-10 to 50 $^{\circ}\text{C}$ /14 to 122 $^{\circ}\text{F}$
Storage Temp	-20 to 60 $^{\circ}\text{C}$ /-4 to 140 $^{\circ}\text{F}$
Size	188mm x 84 mm x52mm / 7.37 in x 3.31in x 2.05 in
Weight	400g/14.1 oz

10.0 List of accessories

All parts listed in the list of accessories are available from the factory through our dealers.

Please contact your dealer for assistance if you require parts, which do not appear in the list.

List of accessories

Accessories	Part no.
Alu. carrying case	125812
Reference manual	125821
Universal sensor with Pt100 and handle 150mm, \varnothing 3mm, -50 to 250°C	125709
Air-/room sensor, with Pt100 and handle 100mm, \varnothing 6mm, -50 to 250°C	125710
Needle sensor, with Pt100 and cross grip in stainless steel 100mm, \varnothing 3mm, -50 to 250°C	125711
Needle sensor, with Pt100 and handle 100mm, \varnothing 3mm, -50 to 250°C	125712
Universal sensor, with TC-K and handle 150mm, \varnothing 1.5mm, max. 850°C	125713
Universal sensor, with TC-K and handle 150mm, \varnothing 3mm, max. 1000°C	125714
Air-/room sensor, with TC-K and handle 100mm, \varnothing 6mm, max. 250°C	125715
Needle sensor, with TC-K and cross grip in stainless steel 100mm, \varnothing 3mm, max. 400°C	125716
Needle sensor, with TC-K and handle 100mm, \varnothing 3mm, max. 400°C	125717
Reference sensor, with TC-N and intelligent connector 500mm, \varnothing 4.5mm, max. 1205°C	125708
Reference sensor, with TC-N, intelligent connector and accredited certificate, 500mm, \varnothing 4.5mm, max. 1205°C	125814

DTI050 power supply accessories

RS232 serial cable, 2 metres	123958
1 x 9V rechargeable battery	124717
Charger for 124717 battery, 115/230VAC	124718
Mains adapter 9VDC/200mA – 230VAC/115VAC	124720

DTI050 software accessories

JOFRACAL PC software	124915
CON050 configuration software	125844

DTI050 connection accessories

Connector for RTD sensors without intelligence	125702
Connector for RTD sensors with intelligence	125703
Connector for TC sensors without intelligence	125759
Connector for TC sensors with intelligence	125704
2 m. adaptor cable to LEMO connector with intelligence for use with STS-100 and STS-102 sensors	125522
2 m. adaptor cable to Banana connectors with intelligence	125521
2 m. adaptor cable to mini TC-connector with intelligence	125523