

■ GROUND TESTER

6422
6424



ENGLISH

User Manual

 **AEMC**[®]
INSTRUMENTS
CHAUVIN ARNOUX GROUP

Statement of Compliance

Chauvin Arnoux®, Inc. d.b.a. AEMC® Instruments certifies that this instrument has been calibrated using standards and instruments traceable to international standards.

We guarantee that at the time of shipping your instrument has met its published specifications.

An N.I.S.T. traceable certificate may be requested at the time of purchase, or obtained by returning the instrument to our repair and calibration facility, for a nominal charge.

The recommended calibration interval for this instrument is 12 months and begins on the date of receipt by the customer. For recalibration, please use our calibration services. Refer to our repair and calibration section at www.aemc.com.

Serial #: _____

Catalog #: _____

Model #: 6422 / 6424

Please fill in the appropriate date as indicated:

Date Received: _____

Date Calibration Due: _____











Chauvin Arnoux®, Inc.
d.b.a AEMC® Instruments
www.aemc.com

CONTENTS

1. INTRODUCTION	8
1.1. Battery Installation	8
1.2. Battery Charging (Model 6424).....	10
1.3. Desktop Stand	11
1.4. Instrument Interface	11
1.5. Instrument Functions	13
1.6. Buttons and Keys.....	13
1.7. LCD Display.....	15
2. OPERATION	16
2.1. Voltage Measurement.....	16
2.2. Resistance Measurement (2P)	17
2.3. Grounding Resistance Measurement (3P)	20
2.4. AC Current Measurement (Model 6424).....	30
3. SPECIFICATIONS	32
3.1. General Reference Conditions.....	32
3.2. Electrical Specifications	32
3.3. Influences	24
3.4. Uncertainty.....	36
3.5. Environmental Conditions.....	37
3.6. Power Supply.....	37
3.7. Mechanical Specifications.....	38
3.8. International Standards.....	38
3.9. Electromagnetic Compatibility (CEM)	38
4. MAINTENANCE	39
4.1. Cleaning.....	39
4.2. Replacing the batteries	39
REPAIR AND CALIBRATION	40
TECHNICAL AND SALES ASSISTANCE	40
LIMITED WARRANTY	41

Thank you for purchasing the AEMC Ground Tester Model 6422 or 6424. For best results from your instrument and for your safety, read the enclosed operating instructions carefully and comply with the precautions for use. These products must be only used by qualified and trained users.

	WARNING, risk of DANGER! The operator must refer to these instructions whenever this danger symbol appears.
	CAUTION! Risk of electric shock. The voltage at the parts marked with this symbol may be dangerous.
	Useful information or tip.
	Earth/ground.
	Current clamp.
	The product is declared recyclable following a life cycle analysis in accordance with standard ISO 14040.
	Battery.
	Guarantees conformity with European directives and with regulations covering EMC.
	In the European Union, the product must undergo selective disposal for the recycling of electric and electronic material, in compliance with Directive WEEE 2002/96/EC.

Precautions

This instrument is compliant with safety standard IEC 61010-2-030 for voltages up to 600V in category IV. Do not use the instrument for measurements on circuits that are not in measurement categories II, III, or IV or that might be connected inadvertently to circuits that are not in measurement categories II, III, or IV.

- The operator and/or the responsible authority must carefully read and clearly understand the various precautions to be taken in use. Sound knowledge and a keen awareness of electrical hazards are essential when using this instrument.
- If you use this instrument other than as specified, the protection it provides may be compromised, thereby endangering you.
- Do not use the instrument on networks of which the voltage or category exceeds those mentioned.
- Do not use the instrument if it seems to be damaged, incomplete, or poorly closed.
- Before each use, check the condition of the insulation on the leads, housing, and accessories. Any item of which the insulation is deteriorated (even partially) must be set aside for repair or scrapping.
- Before using your instrument, check that it is perfectly dry. If it is wet, it must be thoroughly dried before it can be connected or used.
- The use of leads (or accessories) of a lower voltage or category limits the voltage or category of the combined instrument and leads (or accessories) to that of the leads (or accessories).
- Use personal protection equipment systematically.
- When handling the leads, test probes, and alligator clips, keep your fingers behind the physical guard.
- All troubleshooting and metrological checks must be performed by competent and accredited personnel.

Definition of Measurement Categories (CAT)

CAT IV Measurement category IV corresponds to measurements taken at the source of low-voltage installations.

Example: power feeders, counters and protection devices.

CAT III Measurement category III corresponds to measurements on building installations.

Example: distribution panel, circuit-breakers, machines or fixed industrial devices.

CAT II Measurement category II corresponds to measurements taken on circuits directly connected to low-voltage installations.

Example: power supply to domestic electrical appliances and portable tools.

Receiving Your Shipment

Upon receiving your shipment, make sure that the contents are consistent with the packing list. Notify your distributor of any missing items. If the equipment appears to be damaged, file a claim immediately with the carrier and notify your distributor at once, giving a detailed description of any damage. Save the damaged packing container to substantiate your claim.

Ordering Information

Ground Tester Model 6422..... **Cat. #2135.55**
Includes 6 AA alkaline batteries, carrying bag and user manual

Ground Tester Model 6422 Kit-150 ft **Cat. #2135.56**
Includes ground tester, two 150 ft color-coded leads on spools (red/blue), one 30 ft lead (green), two T-shaped auxiliary ground electrodes, set of two 5 ft color-coded (red/blue) leads, one 100 ft AEMC® tape measure, 6 AA batteries, carrying bag and user manual

Ground Tester Model 6424..... **Cat. #2135.57**
Includes 6 AA rechargeable NiMH batteries, USB to wall charger, 5V, 2A, USB charger cable, carrying bag and user manual

Ground Tester Model 6424 Kit-150 ft **Cat. #2135.58**
Includes ground tester, two 150 ft color-coded leads on spools (red/blue), one 30 ft lead (green), two T-shaped auxiliary ground electrodes, set of two 5 ft color-coded (red/blue) leads, one 100 ft AEMC® tape measure, 6 AA rechargeable NiMH batteries, USB to wall charger, 5V, 2A, USB charger cable, carrying bag and user manual

Ground Tester Model 6424 Kit-300 ft **Cat. #2135.59**
Includes ground tester, two 300 ft color-coded leads on spools (red/blue), two 100 ft color-coded leads (hand-tied, green/black), four T-shaped auxiliary ground electrodes, set of two 5 ft color-coded (red/blue) leads, one 100 ft AEMC® tape measure, 6 AA rechargeable NiMH batteries, USB to wall charger, 5V, 2A, USB charger cable, carrying bag and user manual

Accessories

Ground Rod – Set of 2, 17” stainless steel T-shaped
auxiliary rods **Cat. #2135.44**

AC Current Probe Model MN72 for use with Model 6424 only... **Cat. #2153.06**

Calibration checker for ground tester models 6422/6424..... **Cat. #5000.92**

Replacement Parts

Bag – Multi-purpose large canvas bag (replacement for ground kits)	Cat. #2119.82
Case – Replacement carrying case for Models 3620, 3640, 4600, 4610, AN1, 6422, 6424, 6501 & 6503.....	Cat. #2126.71
Tape measure – AEMC [®] 100 ft	Cat. #2130.60
Test Kit for 3-Point Testing	Cat. #2135.35
<i>Includes two 150 ft color-coded leads on spools (red/blue), one 30 ft lead (green), two T-shaped auxiliary ground electrodes, set of two 5 ft color-coded (red/blue) leads, one 100 ft AEMC[®] tape measure, and carrying bag</i>	
Ground Rod – Set of 2, 14.5" T-shaped auxiliary rods	Cat. #2135.39
Cable – Replacement USB charger cable w/wall plug for Model 6424	Cat. #2135.93

1. INTRODUCTION

1.1 Battery Installation

1. Open the battery compartment cover.
2. With your fingers on either side of the cover, insert a tool (for example a screwdriver) in the latching system, and lift up.

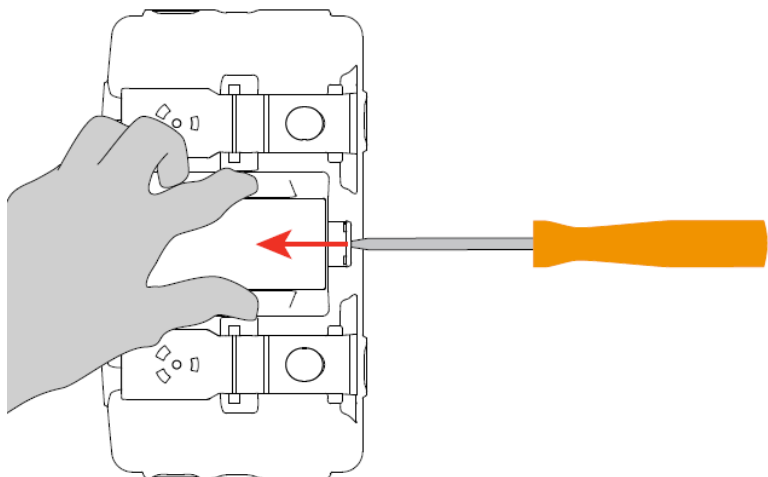

3. Remove the battery compartment cover.

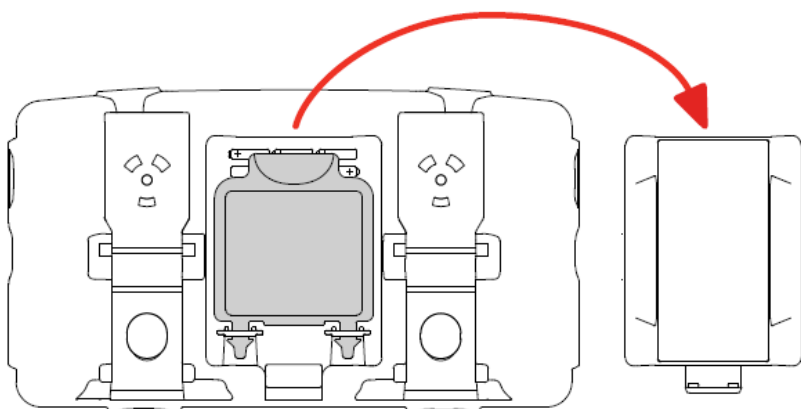

4. Pull open the rubber seal covering the battery compartment.

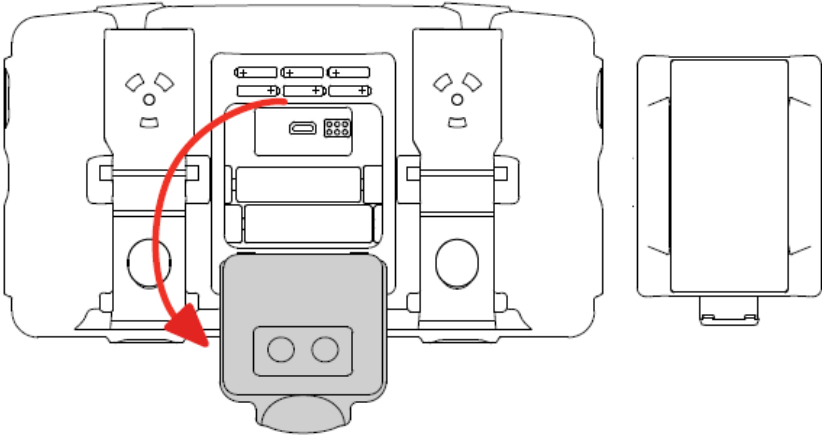

5. Insert the batteries, ensuring correct polarities. We recommend disposable batteries for the Model 6422 (for example alkaline) and rechargeable batteries for the Model 6424. The Model 6422 comes with alkaline batteries installed, and the Model 6424 with rechargeable batteries installed.
6. Press the rubber seal back in place, ensuring it correctly covers the compartment.
7. Replace the battery compartment cover.



If you insert disposable batteries in the Model 6424, the batteries will last longer but the battery level indicator will be inaccurate.

If you insert rechargeable batteries in the Model 6422, the battery level indicator will always display low battery level  and the batteries will not last as long.

1.2 Battery Charging (Model 6424)

Before using the Model 6424 for the first time, you should fully charge the battery. Charging must be done in a location with the temperature between 32 and 104°F (0 and 40°C).



Do not perform the charging procedure if disposable batteries are installed in the instrument.

1. Connect one end of the provided USB cable to the Model 6424 terminal block and the other end to a wall outlet using the provided external-power-to-USB adapter.

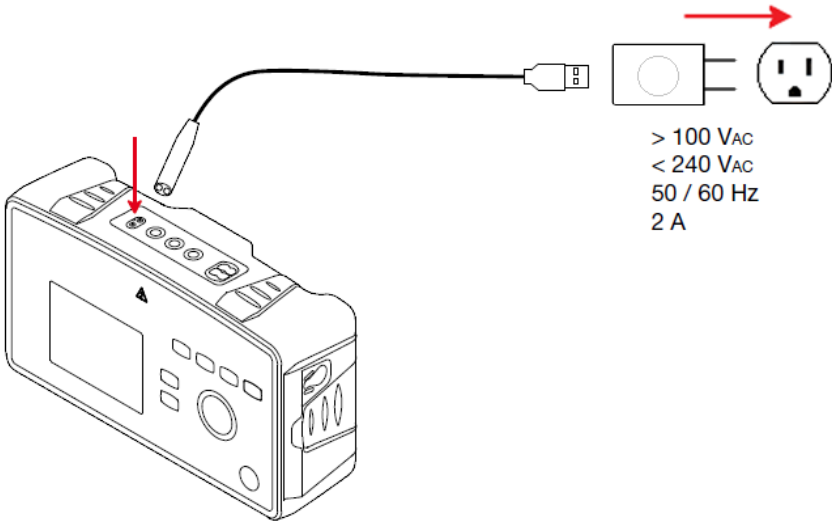

2. The instrument displays CHrG. While the battery charges, the battery level indicator displays progress. Full charging requires approximately 6 hours.
3. When the battery level indicator shows full charge  disconnect the USB cable from the instrument.

1.3 Desktop Stand

The instrument is equipped with two back supports that enable desktop operation from an angled position. Pull the supports out to lock them in place, then place the instrument on a flat surface.

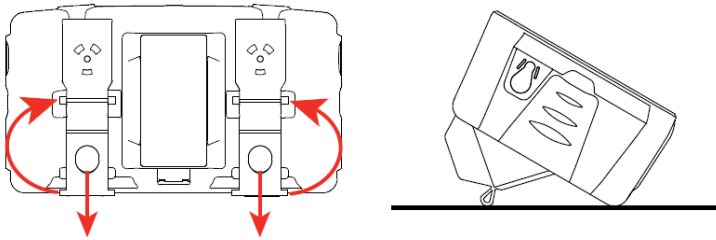

1.4 Instrument Interface

1.4.1 Model 6422

Terminal block:
3 measurement
terminals

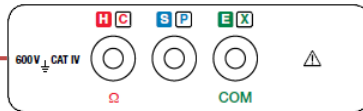

Hazardous
voltage indicator

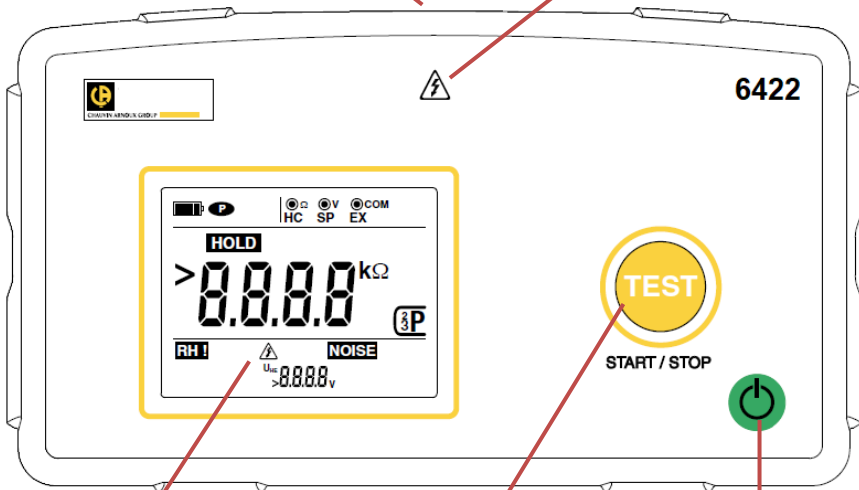

Backlit LCD display

TEST button

ON/OFF button

1.4.2 Model 6424

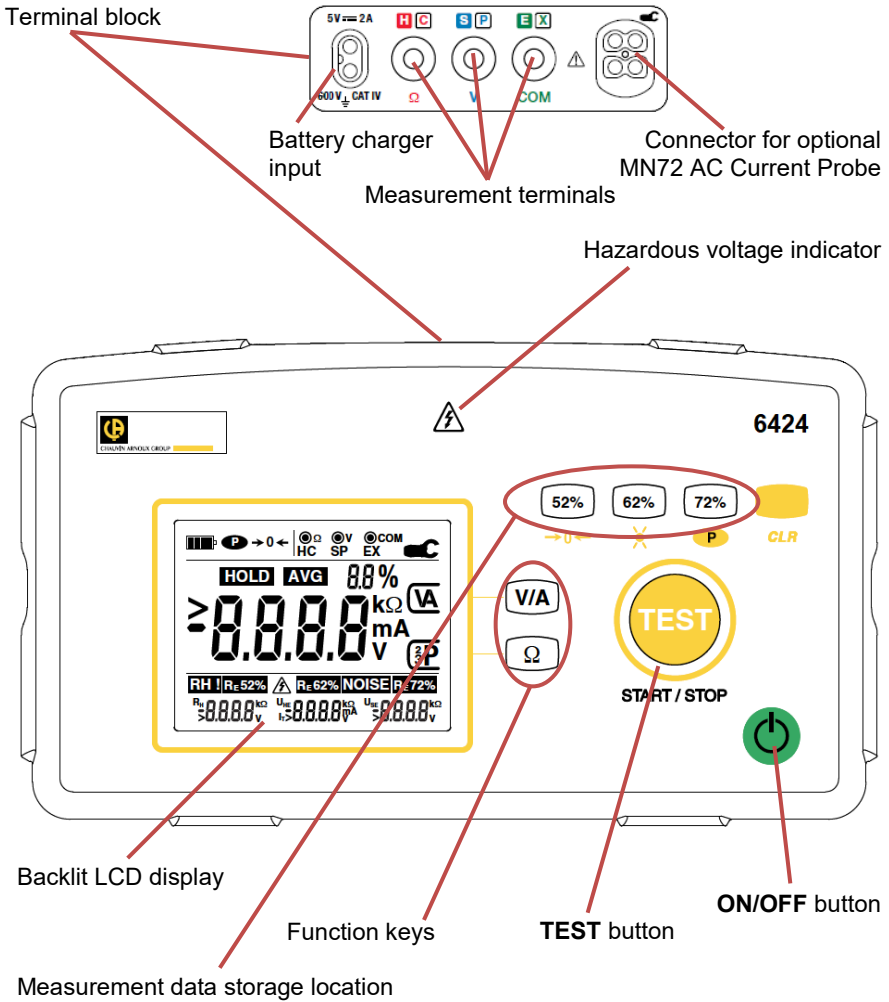

1.5 Instrument Functions



The Models 6422 and 6424 are battery-powered portable measuring instruments with LCD displays.

These instruments check the safety of electrical installations. They can be used to test a new installation before it is powered up. They can also check an existing installation (after it has been disconnected) or diagnose a malfunction in an installation.















Function	6422	6424
Ground resistance measurement (with three rods)	✓	✓
Voltage measurement	✗	✓
Resistance measurement	✓	✓
Average of ground measurements at 52, 62, and 72%	✗	✓
R_H over limit detection	✓	✓
R_E over limit detection	✓	✓
Stray or foreign voltage on U_{SE} detection	✓	✓
AC current measurement with current clamp (optional)	✗	✓

1.6 Buttons and Keys

Both models:

Buttons	Function
	Long press (>2 seconds) turns instrument ON. Second long press turns instrument OFF.
TEST	Short press starts ground measurements in automatic mode (§2.3.3). Long press starts ground measurements in permanent mode. Pressing TEST during a measurement stops the measurement (§2.3.5). At the end of the measurement, pressing TEST exits the frozen measurement display.
 + TEST	Pressing  and TEST simultaneously for >5 seconds while turning ON the instrument changes the names of the H, S, E terminals to C, P, X (§2.3.2).

Model 6424 only:

Keys	Function
<p>V/A</p>	<p>V/A takes voltage measurements (§2.1), or current measurements if a current probe is connected (§2.4). In the latter case, a second press forces voltage measurements.</p>
<p>Ω</p>	<p>Ω takes resistance measurements (§2.2). Ω and TEST pressed simultaneously takes ground resistance measurements (§2.3).</p>
<p>52% 0</p>	<p> stores the displayed measurement with the S rod at 52% of the distance (§2.3.4). Pressing  and then  activates/deactivates lead compensation. Pressing  and then  for >2 seconds compensates the resistance of the leads for the resistance measurement (§2.2.2).</p>
<p>62% </p>	<p> stores the displayed measurement with the S rod at 62% of the distance (§2.3). Pressing  and then  turns on backlighting for one minute, or turns backlighting off.</p>
<p>72%</p>	<p> stores the displayed measurement with the S rod at 72% of the distance (§2.3.4). Pressing  and then  deactivates the Auto Off feature.</p>
<p> CLR</p>	<p> activates the “second” functions of the 52%, 62%, and 72% keys (§2.3). Pressing  for >2 seconds erases the values stored in memory.</p>

1.7 LCD Display

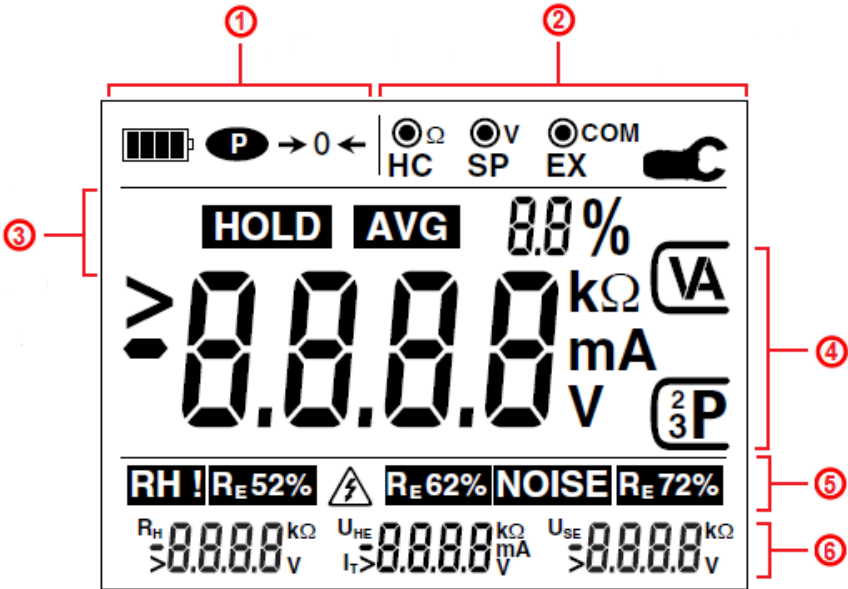

1. Battery level indicator
Auto Off enabled/disabled
lead compensation
2. Input terminals
3. In a 3P ground measurement:
HOLD indicates measurement is frozen
AVG indicates the displayed measurement is the average of 3 measurements
% indicates the range of variation in the averaged measurements
4. Main display
5. Errors in the displayed measurement and (**Model 6424**) in the ground measurement stored in memory
6. (**Model 6424**) additional information about the ground measurement

2. OPERATION

2.1 Voltage Measurement (Model 6424)

The Model 6424 measures the RMS (Root Mean Square) voltage up to 600V_{AC}.



1. Turn ON the instrument by pressing  for >2 seconds.



2. Press  to access the voltage measurement mode. The symbol **V** appears on the right side of the LCD.

3. Connect one end of the leads to the **V** and **COM** terminals and the other end to the sample under test.

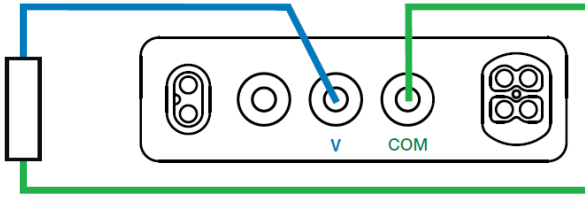

The measurement appears on the LCD.



If the measurement falls outside the instrument's measurement range, the LCD displays **>700.0V**.

2.2 Resistance Measurement (2P)

2.2.1 Model 6422



The sample under test should not be live.



1. Turn ON the instrument by pressing  for >2 seconds. The symbol ²P appears on the right side of the LCD.

2. Connect one end of the leads to the Ω and COM terminals and the other end to the sample under test.

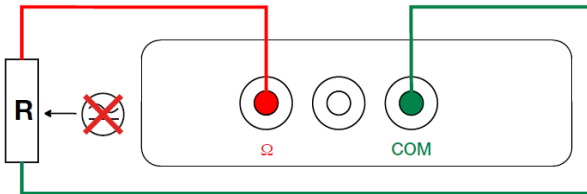

The measurement appears on the LCD.

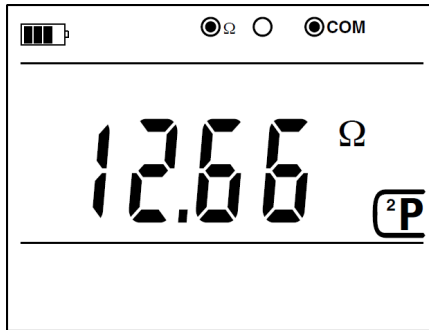

2.2.2 Model 6424



The sample under test should be de-energized.



1. Turn ON the instrument by pressing  for >2 seconds. The symbol **2P** appears on the right side of the LCD.



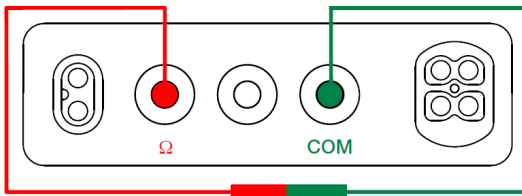

2. If the Model 6424 is already ON but in voltage or current measurement mode, press  to access the resistance measurement mode.

3. Before making measurements, perform lead compensation. This subtracts the test lead resistance from the measurement. Connect one end of the leads to the **Ω** and **COM** terminals and touch the other ends together, creating a short-circuit.

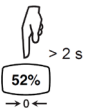

4. Press the  button.



5. Press  for >2 seconds. The **→ 0 ←** symbol blinks during the compensation procedure. When finished, the LCD displays **00.00Ω**.



If the message **Err** appears, the compensation procedure failed, either because the value to be compensated exceeds 5Ω or because the leads were disconnected during compensation.

Press **→ 0 ←** to deactivate/reactivate lead compensation.

6. Connect one end of the leads to the Ω and **COM** terminals and the other end to the sample under test.

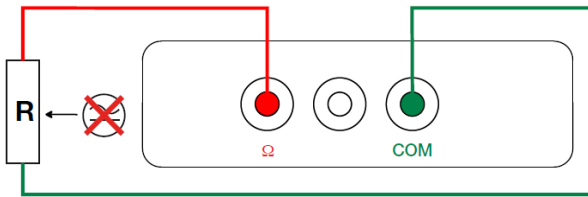

The measurement appears on the LCD.

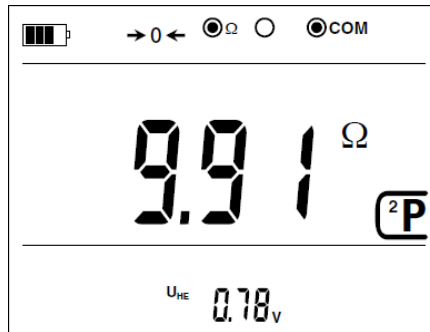

The instrument displays the measured value minus the compensation. The value displayed may be negative if the leads used for the measurement are not the ones that were compensated. In this case, repeat the compensation. Lead compensation is preserved after Auto Off but not after the instrument is manually turned OFF.



Error messages:

>99.99k Ω : The measured value falls outside the instrument's measurement range.

NOISE: A stray or foreign voltage $U_{HE} > 3V$ is detected between the Ω and **COM** terminals.

 A stray or foreign voltage $U_{HE} > 50V$ is detected between the Ω and **COM** terminals; in this case measurement is not possible.

Note that 2P mode is useful for ensuring the H electrode connection is intact.

2.3 Grounding Resistance (3P)

This function performs a 3-pole (3P) test to measure grounding resistance when the electrical installation to be tested is de-energized (for example a new installation). It uses two auxiliary rods, with the third rod being the grounding electrode to be tested (hence the name 3P or 3-pole). To perform a 3P test, the instrument:

1. Generates a 128Hz square wave between the H and E terminals, with an amplitude of 10V peak. If the measurement is unstable, the test frequency will automatically switch from 128Hz to 256Hz to improve the measurement.
2. Measures the resulting current I_{HE} along with the voltage between the S and E terminals U_{SE} .
3. Calculates the value of $R_E = U_{SE} / I_{HE}$.

The 3P test can also be performed on an existing electrical installation, but the power must be OFF. Whether testing a new or existing installation, the grounding electrode system under test must be isolated from other grounding connections during the measurement.

2.3.1 3-Point Test Theory of Operation

3-Point measurement is used to measure resistance to ground of auxiliary ground electrodes and grids. The potential difference between rods E and S is measured by a voltmeter, and the current flow between rods E and H is measured by an ammeter.

By Ohm's Law $E = RI$ or $R = E/I$, we may obtain the ground electrode resistance R .

If $E = 20V$ and $I = 1A$, then:

$$R = \frac{E}{I} = \frac{20}{1} = 20 \text{ ohms}$$

It is not necessary to calculate all the measurements when using a ground tester. The ground tester will measure directly by generating its own current and displaying the resistance of the ground electrode.

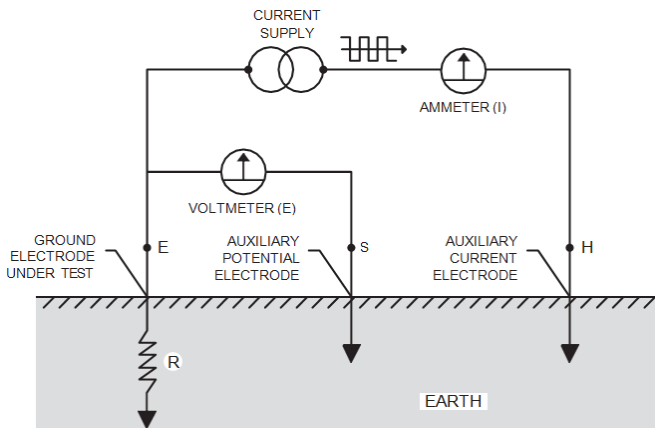

2.3.1.1 Position of the Auxiliary Electrodes in Measurements

The goal in precisely measuring the resistance to ground is to place the auxiliary current electrode H far enough from the ground electrode under test so that the auxiliary potential electrode S will be outside of the effective resistance areas of both the ground electrode and the auxiliary current electrode. The best way to find out if the auxiliary potential rod S is outside the effective resistance areas is to move it between E and H and to take a reading at each location. If the auxiliary potential rod S is in an effective resistance area (or in both if they overlap), by displacing it, the readings taken will vary noticeably in value. Under these conditions, no exact value for the resistance to ground may be determined.

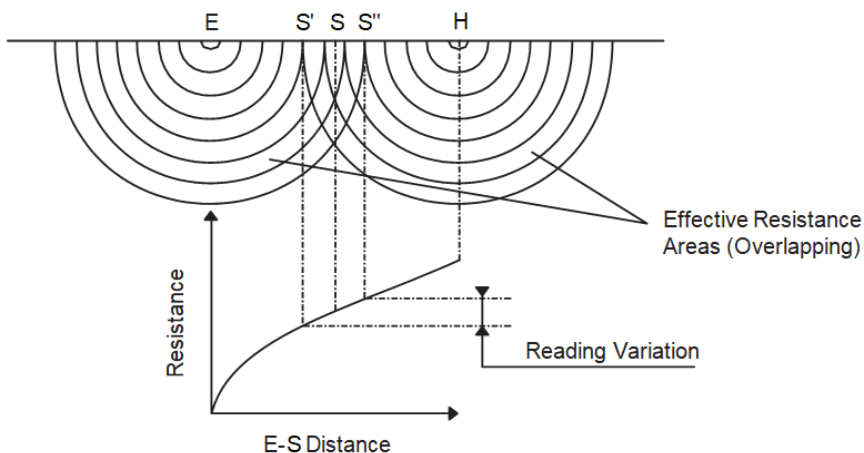

On the other hand, if the auxiliary potential rod S is located outside the effective resistance areas, as S is moved back and forth the reading variation is minimal. The readings taken should be relatively close to each other, and are the best values for the resistance to ground of the ground E. The readings should be plotted to ensure that they lie in a “plateau” region as shown below.

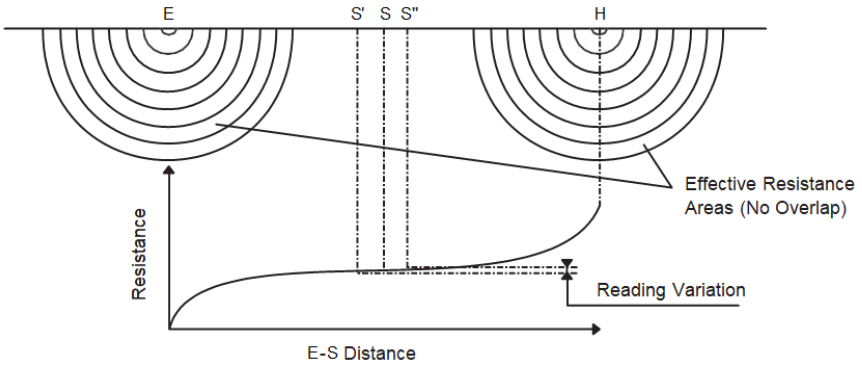

2.3.1.2 Measuring Resistance of Ground Electrodes (62% Method)

The 62% method is the most accurate method but is limited by the fact that the ground tested is a single unit. This method applies only when all three electrodes are in a straight line and the ground is a single electrode, pipe, or plate, etc., as shown below.

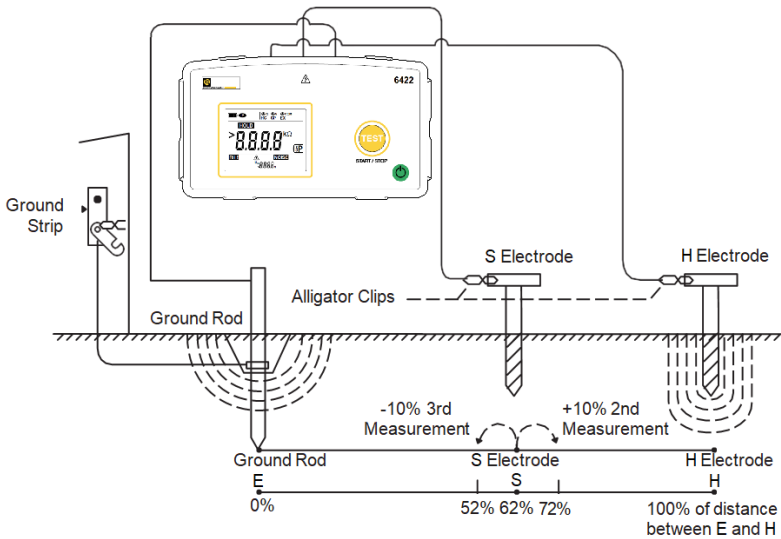

Consider the illustration below, which shows the effective resistance areas (concentric shells) of the ground electrode E and of the auxiliary current electrode H. The resistance areas overlap.

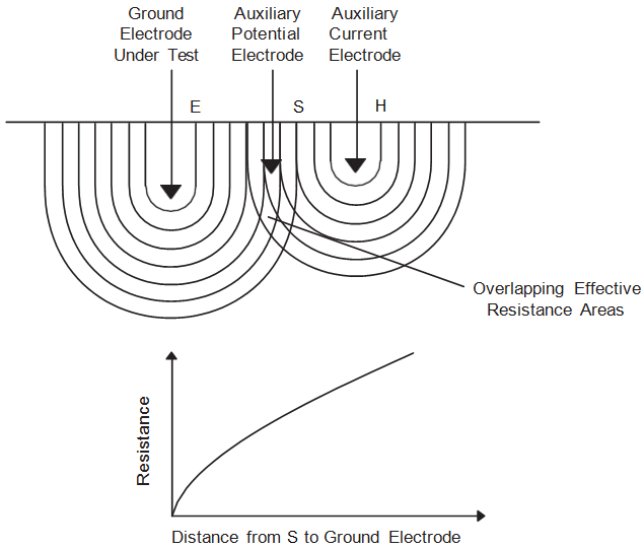

If readings were taken by moving the auxiliary potential electrode S towards either E or H, the reading differentials would be great and we could not obtain a reading within a reasonable band of tolerance. The sensitive areas overlap and act constantly to increase resistance as S is moved away from E.

Now consider the illustration below, where the E and H electrodes are sufficiently spaced so that the areas of effective resistance do not overlap. If we plot the resistance, measured we find that the measurements level off when S is placed at 62% of the distance from E to H, and that the readings on either side of the initial Y setting are most likely to be within the established tolerance band. This tolerance band is defined by the user and expressed as a percent of the initial reading: $\pm 2\%$, $\pm 5\%$, $\pm 10\%$, etc.

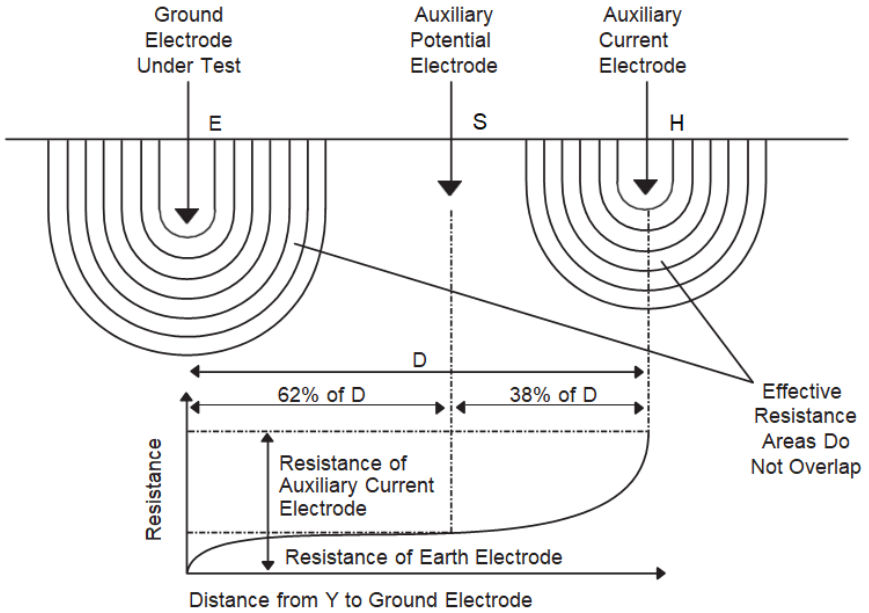

2.3.1.3 Auxiliary Electrode Spacing

No definite distance between X and Z can be given, since this distance is relative to the diameter of the electrode tested, its length, the homogeneity of the soil tested, and particularly, the effective resistance areas. However, an approximate distance may be determined from the following chart which is given for a homogeneous soil and an electrode of 1" in diameter. (For a diameter of 1/2", reduce the distance by 10%; for a diameter of 2" increase the distance by 10%.)

Approximate Distance to Auxiliary Electrodes Using the 62% Method		
Depth Driven	Distance to Y	Distance to Z
6 ft	45 ft	72 ft
8 ft	50 ft	80 ft
10 ft	55 ft	88 ft
12 ft	60 ft	96 ft
18 ft	71 ft	115 ft
20 ft	74 ft	120 ft
30 ft	86 ft	140 ft

2.3.1.4 Multiple Electrode System

A single driven ground electrode is an economical and simple means of making a good ground system, but sometimes a single rod will not provide sufficient low resistance, and several ground electrodes will be driven and connected in parallel by a cable.

Very often when two, three or four ground electrodes are used, they are driven in a straight line. When four or more are used, a hollow square configuration is used and the ground electrodes are still connected in parallel and equally spaced (see below).

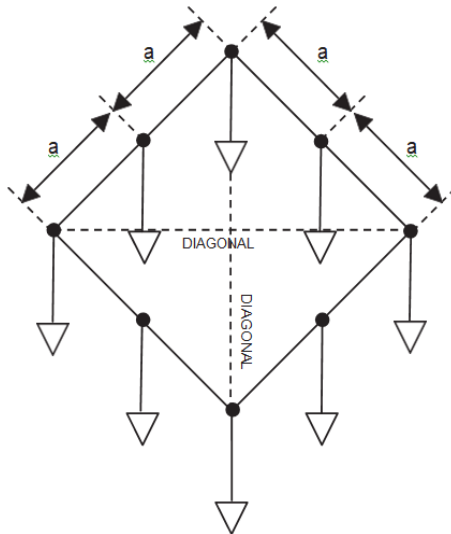



In multiple electrode systems, the 62% method electrode spacing may no longer be applied directly. The distance of the auxiliary electrodes is now based on the maximum grid distance (e.g. in a square, the diagonal; in a line, the total length). A square having a side of 20 ft will have a diagonal of approximately 28 ft.

Multiple Electrode System		
Max Grid Distance	Distance to Y	Distance to Z
6 ft	78 ft	125 ft
8 ft	87 ft	140 ft
10 ft	100 ft	160 ft
12 ft	105 ft	170 ft
14 ft	118 ft	190 ft
16 ft	124 ft	200 ft
18 ft	130 ft	210 ft
20 ft	136 ft	220 ft
30 ft	161 ft	260 ft
40 ft	186 ft	300 ft
50 ft	211 ft	340 ft
60 ft	230 ft	370 ft
80 ft	273 ft	440 ft
100 ft	310 ft	500 ft
120 ft	341 ft	550 ft
140 ft	372 ft	600 ft
160 ft	390 ft	630 ft
180 ft	434 ft	700 ft
200 ft	453 ft	730 ft

2.3.2 Terminals Definitions

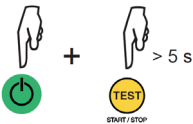
By default, the instrument's terminals are defined as **H**, **S**, and **E**. To change these to **C**, **P**, and **X**:



While turning ON the instrument, simultaneously press and hold down the  and **TEST** buttons for >5 seconds. The terminal assignments will be changed to **C**, **P**, and **X**. These assignments will be retained even when the instrument is turned OFF.

2.3.3 Grounding Resistance Measurement

For the first grounding resistance test, we recommend starting with the 62% distance.

1. Place the H and S rods in a line with the grounding electrode under test. The distance between the S rod and the grounding electrode must be approximately 62% of the distance (d) between the H rod and the grounding electrode. (To avoid electromagnetic interference, we recommend using the full length of the cables, placing them several inches apart and avoiding loops.)

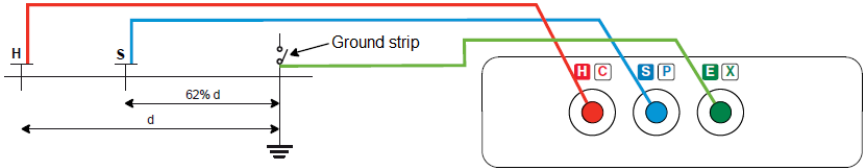

2. Connect the cables to the H and S terminals.
3. Power down the installation and isolate the ground under test from other ground systems and connections.
4. Connect the E terminal to the grounding electrode to be tested.
5. Press **TEST** to take a measurement in automatic mode.



The **TEST** button blinks red, then the measurement is displayed. It remains frozen (**HOLD**) until you press **TEST** again.

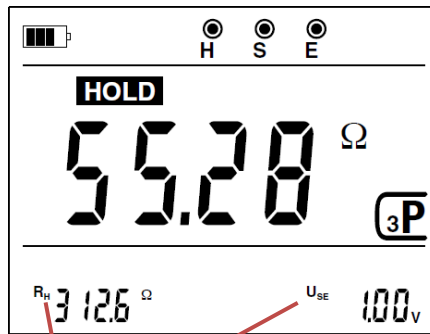

(Model 6424) R_H and U_{SE} values are displayed.

2.3.4 Measurement Average (Model 6424)

After completing the measurement made with the S rod at 62% of the distance between the H rod and the grounding electrode, press **62%** to store the value in memory.

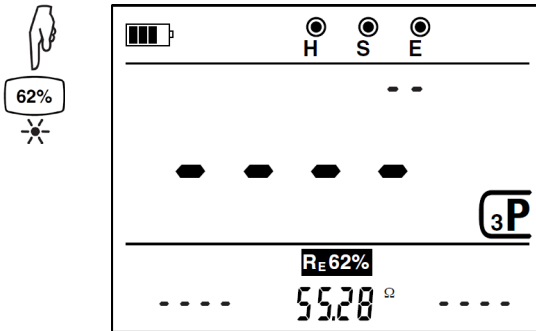

1. Place the S rod at 72% of the distance d and take another measurement.
2. Press **72%** to store the measurement.
3. Place the S rod at 52% of d , and take another measurement.
4. Press **52%** to store the measurement.

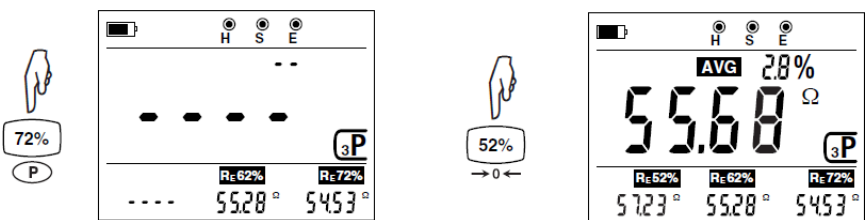
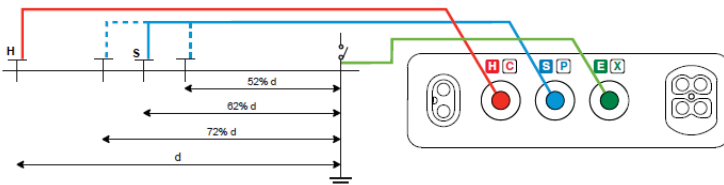

The instrument immediately calculates and displays the average of the three measurements and the percent difference between the lowest and highest values. For the measurement to be valid, the difference must not exceed 5%. If it is, place the H electrode out further and repeat the tests at the 52%, 62%, and 72% distances.

Press **CLR** for >2 seconds to erase the stored measurements.

2.3.5 Measurement Mode (Model 6424)

1. Place the H and S rods and connect the instrument as explained in §2.3.2.



2. Press **TEST** for >2 seconds to start the measurement.

The **TEST** button blinks red, then the measurement is displayed.

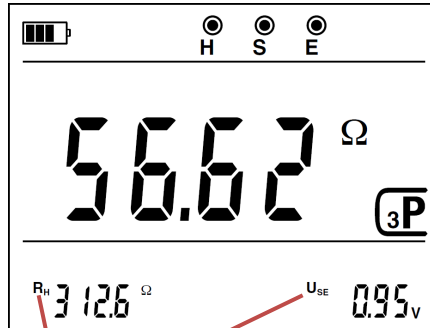

(Model 6424) R_H and U_{SE} values are displayed.

3. Press **TEST** to stop the measurement.

2.3.6 Validating the Measurement

1. Place S rod at 72% of d and take a measurement.
2. Move the S rod to 52% of d and take a measurement.

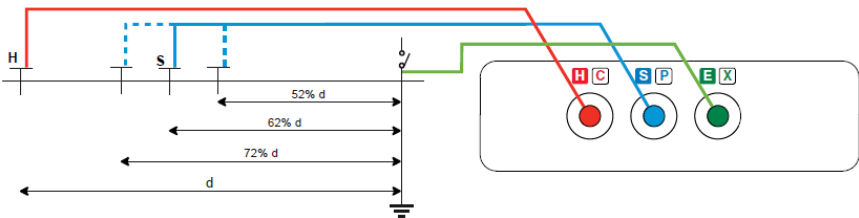

All three measurements must be within 5% of each other for the measurement to be valid. If not, the S rod is within the zone of influence of the grounding electrode. If this is the case, place the H electrode further away and repeat the measurement.

2.3.6.1 Auxiliary Rod Positioning

To ensure measurements are not distorted by interference, we recommend repeating the measurement with the auxiliary rods placed at a different distance and in another direction (for example rotated 90° from the first alignment).

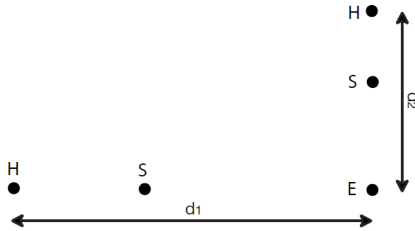

If the measurements match, they are valid. If they differ significantly, they could be influenced by factors such as ground currents or a groundwater artery. In this case, we recommend driving the auxiliary rods deeper into the ground.

If in-line rod configuration is not possible, you can place the rods in an equilateral triangle. To validate the measurement, move the S rod on either side of the line HE.

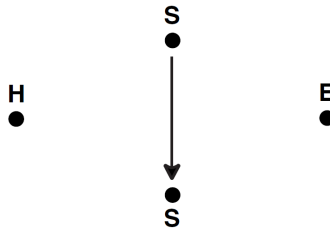

2.3.6.2 Ground Measurement Tips

- To avoid “cross-talk” with the measurement current, do not route the connecting cables of the rods near or parallel to other cables (transmission or power supply), metal pipes, rails, or fences.
- To reduce auxiliary rod resistance, add one or more rods, two meters apart, in the H (S) circuit of the circuit.
- Another way to reduce rod resistance is to drive the rods deeper and firmly pack the earth around them, or sprinkle water on them.



After completing the measurement, reconnect the grounding strip before restoring power to the installation.

2.3.7 Error Messages

>3.000kΩ	(Model 6422) Measurement outside range
>60.00kΩ	(Model 6424) Measurement outside range
Ⓢ (blinking) Ⓟ (blinking)	S rod resistance >50kΩ
RH ! (blinking)	H rod resistance >15kΩ
NOISE	U _{SE} or U _{HE} voltage amplitude is between 3 and 50V
⚡ (blinking)	U _{SE} or U _{HE} > 50V (no measurement is possible)

2.4 AC Current Measurement (Model 6424)



AC current measurement requires an optional MN72 current probe.



1. Turn ON the instrument by pressing  for >2 seconds.



2. Press .

3. Connect the clamp to the instrument's current terminal (identified by the  symbol). The **A** and  symbols appear on the LCD.
4. Open the clamp and place it on the conductor under test.

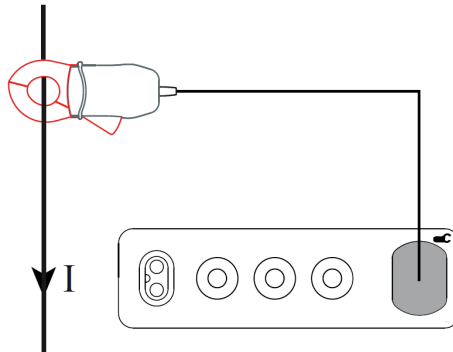

The measurement appears on the LCD.

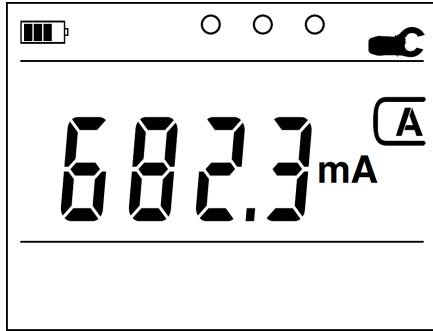

Error messages:

>70.00A: The measured value falls outside the instrument's measurement range.

Err: The probe is not completely inserted (the  symbol also blinks).

3. SPECIFICATIONS

3.1 General Reference Conditions

Quantity of influence	Reference values
Temperature	73 ± 3.6 °F (23 ± 2 °C)
Relative humidity	45 to 75% RH
Supply voltage	Model 6422: 8 ± 0.2 V Model 6424: 6 ± 0.2 V
Frequency	45 to 65Hz
Electric field	< 0.1V/m
Magnetic field	< 40A/m

Intrinsic uncertainty is the error defined under the reference conditions.

Operating uncertainty includes the intrinsic uncertainty plus the effects of variation of the quantities of influence (supply voltage, temperature, interference, etc.) as defined in standard IEC 61557-5.

The uncertainties are expressed in % of the reading (R) and in number of display counts (ct): ± (a% R + b ct)



The Model 6424 cannot make measurements when the battery charger is connected.

3.2 Electrical Specifications

3.2.1 Voltage Measurement

Additional reference condition:

Peak factor = $\sqrt{2}$

U_{HE} Voltage Measurement

Measurement range	0.1 – 600.0V
Resolution	0.1V
Intrinsic uncertainty	± (1% R + 1 ct)

3.2.2 Resistance Measurement (2P)

Additional reference conditions:

External voltage between H and E terminals = zero.
Resistance of the leads $\leq 0.1\Omega$.

Measurement range	0.05 - 99.99 Ω	80.0 - 999.9 Ω	0.800 - 9.999k Ω	8.00 - 50.00k Ω
Resolution	0.01 Ω	0.1 Ω	1 Ω	10 Ω
Intrinsic uncertainty	$\pm (2\% R + 10 \text{ ct})$	$\pm (2\% R + 2 \text{ ct})$	$\pm (2\% R + 1 \text{ ct})$	$\pm (2\% R + 1 \text{ ct})$
U_{HE} no-load voltage	$\pm 10V_{PEAK}$			

The compensation of the leads of the Model 6424 may result in a negative reading of up to 5 Ω .

3.2.3 Ground Resistance Measurement (3P)

Additional reference conditions:

Resistance of the E lead: $\leq 0.1\Omega$
 R_H (rod + lead) $\leq 100\Omega$
 R_S (rod + lead) $\leq 1k\Omega$
 Spurious voltages on U_{HE} and $U_{SE} \leq 0.01V$

Model 6422 Ground Measurement

Measurement range	0.50 - 99.99 Ω	80.0 - 999.9 Ω	0.800 - 2.000k Ω
Resolution	0.01 Ω	0.1 Ω	1 Ω
Intrinsic uncertainty	$\pm (1\% R + 10 \text{ ct})$	$\pm (1\% R + 2 \text{ ct})$	$\pm (1\% R + 1 \text{ ct})$
Measurement frequency	128Hz or 256Hz		
No-load voltage	$\pm 10V_{PEAK}$		

Model 6424 Ground Measurement

Measurement range	0.50 - 99.99 Ω	80.0 - 999.9 Ω	0.800 - 9.999k Ω	8.00 - 50.00k Ω
Resolution	0.01 Ω	0.1 Ω	1 Ω	10 Ω
Intrinsic uncertainty	$\pm (1\% R + 10 \text{ ct})$	$\pm (1\% R + 2 \text{ ct})$	$\pm (1\% R + 1 \text{ ct})$	$\pm (1\% R + 1 \text{ ct})$
Measurement frequency	128Hz, or 256Hz if the spurious voltage is at 128Hz			
No-load voltage	$\pm 10V_{PEAK}$			

The measurement current is a square signal of not more than 20mA.

R_H Ground Electrode Resistance Measurement (Model 6424)

Measurement range	0.050 – 9.999k Ω	8.00 – 49.99k Ω
Resolution	1 Ω	10 Ω
Intrinsic uncertainty	$\pm (10\% R + 1 \text{ ct})$	$\pm (10\% R + 1 \text{ ct})$

U_{SE} Voltage Measurement (Model 6424)

Measurement range	0.10 - 99.99V _{AC/DC}	80.0 - 600.0V _{AC/DC}
Resolution	0.01V	0.1V
Intrinsic uncertainty	$\pm (2\% R + 2 \text{ ct})$	$\pm (2\% R + 2 \text{ ct})$

The instrument is protected up to 600V between any two of the three input terminals.

3.2.4 Current Measurement (Model 6424)

Additional reference condition:

Peak factor = $\sqrt{2}$

Measurement range	0.5 - 999.9mA	0.800 - 9.999A	8.00 - 60.00A
Resolution	0.1mA	1mA	10mA
Intrinsic uncertainty	$\pm (1\% R + 4 \text{ ct})$	$\pm (1\% R + 2 \text{ ct})$	$\pm (1\% R + 2 \text{ ct})$

3.3 Influences

3.3.1 Voltage Measurement (Model 6424)

Quantities of influence	Limits of the range of use	Variation of the measurement	
		Typical	Maximum
Temperature	14 to + 122 °F (-10 to + 50 °C)	$\pm 0.2\% R$	$\pm (0.5\% R + 1 \text{ ct})$
Relative humidity	10 to 90% RH	-	$\pm 2\% R$
Frequency	DC to 440Hz	-	-3dB
Peak factor	1.4 to 3 (up to 300V)	-	$\pm 1\% R$
DC and 50/60Hz common mode rejection	0 to 600V _{AC}	65dB	50dB

3.3.2 Resistance Measurement (2P)

Quantities of influence	Limits of the range of use	Variation of the measurement	
		Typical	Maximum
Temperature	14 to + 122 °F (-10 to + 50 °C)	± (25 ppm R + 10mΩ/°C)	± (200 ppm R + 2 mΩ/°C)
Relative humidity	10 to 90% RH	± 1% R	± 2% R
Supply voltage	Model 6422: 6.0 to 9.6V Model 6424: 6.0 to 7.6V	-	± (2% R + 1Ω)
50/60Hz voltage superimposed on the test voltage	0 to 3V 3 to 25V	± (0.5% R + 0.5Ω) ± (2% R + 5Ω)	± (2% R + 1Ω) ± (4% R + 10Ω)

3.3.3 Ground Measurement (3P)

Quantities of influence	Limits of the range of use	Variation of the measurement	
		Typical	Maximum
Temperature	14 to + 122 °F (-10 to + 50 °C)	± 1% R	± 2% R
Relative humidity	10 to 90% RH	-	± 2% R
Supply voltage	Model 6422: 6.0 to 9.6V Model 6424: 6.0 to 7.6V	-	± (2% R + 1Ω)
Voltage in series between S and E, 50/60Hz	0 to 3V	± (0.5% R + 0.2Ω)	± (1% R + 1Ω)
	3 to 25V	± (2% R + 8Ω)	± (4% R + 20Ω)
Voltage in series between H and E, 50/60Hz	0 to 3V	± (0.5% R + 0.2Ω)	± (1% R + 1Ω)
	3 to 25V	± (20% R + 10Ω)	± (30% R + 20Ω)
Rod resistance R _S	0 to 50 kΩ	-	± (2% R + 1Ω)
Rod resistance R _H	R _H < 100 x R _E and R _H < 50kΩ	± (2% R + 2 ct)	± (10% R + 5 ct)

3.3.4 Current Measurement (Model 6424)

Quantities of influence	Limits of the range of use	Variation of the measurement	
		Typical	Maximum
Temperature	14 to + 122 °F (-10 to + 50 °C)	± 250 ppm R	± 500 ppm R
Relative humidity	10 to 90% RH	± 0% R	± 1% R
Frequency	DC to 440Hz	-	-3dB
Peak factor	1.4 to 3 (up to 30A)	± 0% R	± 1%

3.4 Uncertainty

The instruments comply with standard IEC-61557 part 5, which requires that the operating uncertainty (B) be less than 30%.

In ground measurement:

$$B = \pm \left(|A| + 1.15 \sqrt{E_1^2 + E_2^2 + E_3^2 + E_4^2 + E_5^2 + E_7^2 + E_8^2} \right)$$

with

A = intrinsic uncertainty

E₁ = influence of the reference position ± 90°

E₂ = influence of the supply voltage within the limits indicated by the manufacturer

E₃ = influence of the temperature between 32 and 95°F (0 and 35°C)

E₄ = influence of the interference voltage in series mode (3V at 16.6; 50; 60 and 400Hz)

E₅ = influence of the resistance of the rods from 0 to 100 x R_A but ≤ 50kΩ

E₇ = influence of the network frequency from 99 to 101% of the nominal frequency

E₈ = influence of the network voltage from 85 to 110% of the nominal voltage

The uncertainty of operation of the instrument is ≤ 15% + 1Q

3.5 Environmental Conditions

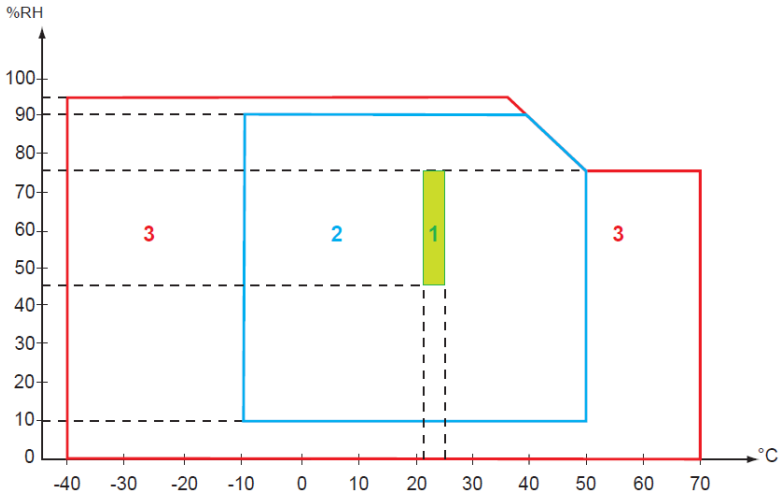

1 = Reference range, 70 to 77°F (21 to 25°C)

2 = Operating range, 14 to 122°F (-10 to +50°C)

3 = Storage range (without batteries), -40 to +158°F (-40 to +70°C)

Range for recharging of the rechargeable batteries; 32 to 104°F (0 to 40°C)

Indoor and outdoor use

Altitude < 6500' (2,000m)

Pollution degree 2

3.6 Power Supply

Model 6422: 6 LR6 or AA disposable batteries.

Model 6424: 6 NiMH type AA rechargeable batteries. The charging time is approximately 6 hours.



During charging, the instrument cannot make measurements. All front panel buttons are disabled.

Typical time between battery charges

Function	Model 6422 (disposable batteries)	Model 6424 (rechargeable batteries)
Voltage / Current	> 80h	> 50h
Resistance	> 2500 measurements from 5s to 100Ω	> 2000 measurements from 5s to 100Ω
Ground test (3P)	> 2000 measurements from 100Ω	> 1500 measurements from 100Ω
Instrument off	> 1 year	> 1 year

3.7 Mechanical Specifications

Dimensions (L x D x H): 8.78 x 4.96 x 2.75" (223 x 126 x 70mm)

Weight: approximately 2.2 lb (1kg)

Protection class: IP 65 per IEC 60 529 IK 04
per IEC 50102

Free fall test: 1 meter per IEC 61010-1

3.8 International Standards

The instrument:

- Conforms with IEC 61010-2-030, 600V CAT IV, pollution degree 2.
Assigned characteristics: measurement CAT IV, 600 V with respect to earth.
- Complies with IEC 61557 parts 1 and 5.
- Is protected by reinforced insulation.

3.9 Electromagnetic Compatibility (CEM)

The instrument conforms with standard IEC 61326-1.

4. MAINTENANCE



Except for the batteries, the instrument contains no parts that can be replaced by personnel who have not been specially trained and accredited. Any unauthorized repair or replacement of a part by an “equivalent” may severely impair safety.

4.1 Cleaning

Disconnect the instrument from all leads, probes, etc. and turn it OFF.

Use a soft cloth, dampened with soapy water. Rinse with a damp cloth and dry rapidly with a dry cloth or forced air. Do not use alcohol, solvents, or hydrocarbons.

4.2 Battery Replacement

1. Disconnect the instrument from all leads, probes, etc. and turn it OFF.
2. Open the battery compartment as instructed in §1.1.
3. Remove the old batteries.
4. Insert new batteries as instructed in §1.1.



Spent batteries must not be treated as ordinary household waste. Take them to the appropriate recycling collection facility.

REPAIR AND CALIBRATION

To ensure that your instrument meets factory specifications, we recommend that it be sent back to our factory Service Center at one-year intervals for recalibration, or as required by other standards or internal procedures.

For instrument repair and calibration:

You must contact our Service Center for a Customer Service Authorization Number (CSA#). This will ensure that when your instrument arrives, it will be tracked and processed promptly. Please write the CSA# on the outside of the shipping container. If the instrument is returned for calibration, we need to know if you want a standard calibration; or a calibration traceable to N.I.S.T. (includes calibration certificate plus recorded calibration data).

Ship To: Chauvin Arnoux[®], Inc. d.b.a. AEMC[®] Instruments
15 Faraday Drive
Dover, NH 03820 USA
Phone: (800) 945-2362 (Ext. 360)
(603) 749-6434 (Ext. 360)
Fax: (603) 742-2346 or (603) 749-6309
E-mail: repair@aemc.com

(Or contact your authorized distributor)

Cost for repair, standard calibration, and calibration traceable to N.I.S.T. are available.

NOTE: You must obtain a CSA# before returning any instrument.

TECHNICAL AND SALES ASSISTANCE

If you are experiencing any technical problems, or require any assistance with the proper operation or application of your instrument, please call, mail, fax or e-mail our technical support team:

Chauvin Arnoux[®], Inc. d.b.a. AEMC[®] Instruments
Phone: (800) 343-1391
(508) 698-2115
Fax: (508) 698-2118
E-mail: techsupport@aemc.com
www.aemc.com

NOTE: Do not ship instruments to our Foxborough, MA address.

LIMITED WARRANTY

The instrument is warranted to the owner for a period of two years from the date of original purchase against defects in manufacture. This limited warranty is given by AEMC® Instruments, not by the distributor from whom it was purchased. This warranty is void if the instrument has been tampered with or abused, or if the defect is related to service not performed by AEMC® Instruments. The warranty does not apply in the following cases:

- Inappropriate use of the equipment or use with incompatible equipment.
- Modifications made to the equipment without the explicit permission of the manufacturer's technical staff.
- Work done on the device by a person not approved by the manufacturer.
- Adaptation to a particular application not anticipated in the definition of the equipment or not indicated in this user's manual.
- Damage caused by shocks, falls, or floods.

Full warranty coverage and product registration is available on our website at www.aemc.com/warranty.html. Please print the online Warranty Coverage Information for your records.

What AEMC® Instruments will do: If a malfunction occurs within the warranty period, you may return the instrument to us for repair, provided we have your warranty registration information on file or a proof of purchase. AEMC® Instruments will, at its option, repair or replace the faulty material.

REGISTER ONLINE AT:

www.aemc.com

Warranty Repairs

What you must do to return an Instrument for Warranty Repair:

First, request a Customer Service Authorization Number (CSA#) by phone or by fax from our Service Department (see address below), then return the instrument along with the signed CSA Form. Please write the CSA# on the outside of the shipping container. Return the instrument, postage or shipment pre-paid to:

Chauvin Arnoux®, Inc. d.b.a. AEMC® Instruments
15 Faraday Drive • Dover, NH 03820 USA
Phone: (800) 945-2362 (Ext. 360)
(603) 749-6434 (Ext. 360)
Fax: (603) 742-2346 or (603) 749-6309
E-mail: repair@aemc.com

Caution: To protect yourself against in-transit loss, we recommend you insure your returned material.

NOTE: You must obtain a CSA# before returning any instrument.



03/20

99-MAN 100517 v1

Chauvin Arnoux[®], Inc. d.b.a. AEMC[®] Instruments

15 Faraday Drive • Dover, NH 03820 USA

Phone: (603) 749-6434 • Fax: (603) 742-2346

www.aemc.com
