

▪ POWER CLAMP-ON METER

607



Statement of Compliance

Chauvin Arnoux®, Inc. d.b.a. AEMC® Instruments certifies that this instrument has been calibrated using standards and instruments traceable to international standards.

We guarantee that at the time of shipping your instrument has met its published specifications.

An NIST traceable certificate may be requested at the time of purchase, or obtained by returning the instrument to our repair and calibration facility, for a nominal charge.

The recommended calibration interval for this instrument is 12 months and begins on the date of receipt by the customer. For recalibration, please use our calibration services. Refer to our repair and calibration section at www.aemc.com.

Serial #: _____

Catalog #: _____

Model #: _____

Please fill in the appropriate date as indicated:













Date Received: _____

Date Calibration Due: _____



Chauvin Arnoux®, Inc.
d.b.a AEMC® Instruments
www.aemc.com

CONTENTS

PRECAUTIONS FOR USE	7
MEASUREMENT CATEGORIES.....	8
RECEIVING YOUR SHIPMENT.....	8
ORDERING INFORMATION.....	8
1 PRESENTATION	9
1.1 THE ROTARY SWITCH.....	10
1.2 THE FUNCTION BUTTONS	11
1.3 THE DISPLAY.....	12
1.3.1 Display Symbols	12
1.3.2 Measurement Capacity Exceeded (OL)	13
1.4 THE TERMINALS.....	14
2 THE BUTTONS.....	15
2.1  BUTTON	15
2.2  (YELLOW) BUTTON (second function).....	16
2.3  BUTTON	16
2.4  BUTTON	17
2.5  BUTTON.....	18
2.5.1 Normal Mode	18
2.5.2 The MAX/MIN Mode + Activation of the HOLD Mode	19
2.5.3 Access to the True Inrush [®] Mode ( set switch to ).....	19
2.6  BUTTON	20
2.6.1 Normal Mode	20
2.6.2 Harmonic Order Display  or  + 	20
2.6.3 The Hz Function + Activation of the HOLD Mode	21
3 USE.....	22
3.1 INSTALLING THE BATTERIES	22
3.2 TURNING THE CLAMP-ON METER ON	22
3.3 TURNING THE CLAMP-ON METER OFF	22
3.4 CONFIGURATION.....	23
3.4.1 Auto Power Off.....	23
3.4.2 Configuring the Current Threshold for True InRush [®]	23
3.4.3 Configuring the Recording Duration.....	24
3.4.4 Erasing Recordings from Memory.....	24
3.4.5 Default Configuration	24
3.5 VOLTAGE MEASUREMENT (V)	25
3.6 CONTINUITY TEST 	26
3.7 RESISTANCE MEASUREMENT 	27
3.8 CURRENT MEASUREMENT (A).....	27
3.8.1 AC Measurement	27











3.8.2	DC or AC+DC Measurement	28
3.9	STARTING CURRENT OR OVERCURRENT (True InRush [®]) MEASUREMENT	30
3.10	POWER MEASUREMENTS W, VA, var AND PF	32
3.10.1	Single-Phase Power Measurement.....	32
3.10.2	Balanced 3-Phase Power Measurement.....	33
3.10.3	Four Quadrant Diagram	34
3.11	ENERGY METERING MEASUREMENT	35
3.12	FREQUENCY MEASUREMENT (Hz)	38
3.12.1	Frequency Measurement (V)	38
3.12.2	Frequency Measurement (A)	39
3.13	MEASUREMENT OF THD AND DISPLAY OF HARMONICS ORDER	39
3.13.1	Measurement of the THD (V).....	39
3.13.2	Measurement of the THD (A).....	40
3.13.3	Display of Individual Harmonics & Frequency Of Fundamental. ...	41
3.14	RECORDING OF MEASUREMENTS	42
3.15	Connecting to a Computer.....	42
3.15.1	Bluetooth Connection.....	42
3.15.2	Pairing the Instrument to the Computer	43
3.16	Turning Bluetooth ON/OFF	46
3.17	Recording Data	46
3.17.1	Starting a Recording Session.....	46
3.17.2	Stopping a Recording Session.....	46
3.18	Downloading Recorded Data.....	47
3.19	Erasing Data from Memory.....	47
3.20	Data Storage.....	47
3.20.1	Trend Measurements.....	47
3.20.2	Recording with Memory Cleared.....	47
3.20.3	Recording with a Partial or Full Memory	48
3.20.4	Memory Filled During Recording Session	48
3.21	SOFTWARE INSTALLATION	48
3.21.1	Installing DataView [®]	48
3.22	Opening the DATAVIEW Control Panel	51
3.23	Using the Control Panel	51
3.24	Displaying Real-time Status Information.....	54
3.25	Resizing and Saving Real-time Window Layouts.....	54
3.26	Downloading Recorded Instrument Data	55
3.27	Power Clamp Meter Template.....	57
4	SPECIFICATIONS	62
4.1	REFERENCE CONDITIONS.....	62
4.2	SPECIFICATIONS UNDER THE REFERENCE CONDITIONS	62
4.2.1	DC Voltage Measurement.....	62
4.2.2	AC Voltage Measurement	63
4.2.3	AC+DC Voltage Measurement.....	63
4.2.4	DC Current Measurement	64
4.2.5	AC Current Measurement	64
4.2.6	AC+DC Intensity Measurement	65
4.2.7	True Inrush [®] Measurement	65
4.2.8	Calculation of the crest factor (CF)	66

4.2.9	Calculation of the RIPPLE in DC.....	66
4.2.10	Continuity Measurement	66
4.2.11	Resistance Measurement	66
4.2.12	Active DC Power Measurements	67
4.2.13	Active AC Power Measurements	67
4.2.14	Active AC+DC Power Measurements	69
4.2.15	Measurement of Apparent AC Power	69
4.2.16	Measurement of Apparent AC+DC Power	70
4.2.17	Measurement of Reactive AC Power	70
4.2.18	Measurement of Reactive AC+DC Power	71
4.2.19	Calculation of the Power Factor (PF)	71
4.2.20	Calculation of the Displacement Power Factor (DPF)	72
4.2.21	Frequency Measurements	72
4.2.22	Specifications in THDr	73
4.2.23	Specifications in THDf.....	73
4.2.24	Harmonic Measurement Specifications.....	73
4.3	ENVIRONMENTAL CONDITIONS	74
4.4	MECHANICAL SPECIFICATIONS.....	74
4.5	POWER SUPPLY	74
4.6	COMPLIANCE WITH INTERNATIONAL STANDARDS	75
4.7	ENVIRONMENTAL VARIATIONS	76
5	MAINTENANCE.....	77
5.1	WARNING:.....	77
5.2	CLEANING.....	77
5.3	REPLACEMENT OF THE BATTERIES.....	77
6	REPAIR AND CALIBRATION	78
7	TECHNICAL AND SALES ASSISTANCE.....	78
8	LIMITED WARRANTY	79
9	WARRANTY REPAIRS	79

Thank you for purchasing a **Model 607 Clamp-on Meter**.

For best results from your instrument and for your safety, read the enclosed operating instructions carefully and comply with the precautions for use. These products must be only used by qualified and trained users.

Meanings of the symbols used on the device

	CAUTION - Risk of Danger! Indicates a WARNING and that the operator must refer to the user manual for instructions before operating the instrument in all cases where this symbol is marked.
	Risk of electric shock. The voltage at the parts marked with this symbol may be dangerous.
	Refers to a type A current sensor. This symbol signifies that application around and removal from HAZARDOUS LIVE conductors is permitted.
	1.5 V battery
	The CE marking indicates compliance with European directives
	Double insulation or reinforced insulation
	In the European Union, this product is subject to a separate collection system for recycling electrical and electronic components In accordance with directive WEEE 2002/96/EC
	AC – Alternating current
	AC and DC – Alternating and direct current
	Ground/Earth

PRECAUTIONS FOR USE

This device complies with safety standards IEC-61010-1 and 61010-2-032 for voltages of 1000V in category IV at an altitude of less than 2000m, indoors, with a degree of pollution not exceeding 2.

These safety instructions are intended to ensure the safety of persons and proper operation of the device.

- The operator and/or the responsible authority must carefully read and clearly understand the various precautions to be taken in use.
- If this instrument is used other than as specified, the protection it provides may be compromised, thereby endangering you.
- Do not use the instrument in an explosive atmosphere or in the presence of flammable gases or fumes.
- Do not use the instrument on networks of which the voltage or category exceeds those mentioned.
- Do not exceed the rated maximum voltages and currents between terminals or with respect to earth.
- Do not use the instrument if it appears to be damaged, incomplete, or not properly closed.
- Before each use, check the condition of the insulation on the leads, housing, and accessories. Any element of which the insulation is deteriorated (even partially) must be set aside for repair or scrapped.
- Use leads and accessories rated for voltages and categories at least equal to those of the instrument. If not, an accessory of a lower category lowers the category of the combined Clamp + accessory to that of the accessory.
- Observe the environmental conditions of use.
- Do not modify the instrument and only use factory replacement parts. Repairs and adjustments must be done by approved qualified personnel.
- Replace the batteries as soon as the  symbol appears on the display of the unit. Disconnect all leads before opening the battery compartment cover.
- Use personal protective equipment when conditions require.
- Keep your hands away from the unused terminals of the instrument.
- When handling the test probes, alligator clips, and clamp ammeters, keep your fingers behind the physical guard.
- As a safety measure, and to avoid repeated overloads on the inputs of the device, configuration operations should only be performed when the device is disconnected from all dangerous voltages.

MEASUREMENT CATEGORIES

Definitions of the measurement categories:

CAT II: Circuits directly connected to the low-voltage installation.

Example: power supply to household electrical appliances and portable tools.

CAT III: Power supply circuits in the installation of the building.

Example: distribution panel, circuit-breakers, fixed industrial machines or devices.

CAT IV: Circuits supplying the low-voltage installation of the building.

Example: power lines, meters, and protection devices.

RECEIVING YOUR SHIPMENT

Upon receiving your shipment, make sure that the contents are consistent with the packing list. Notify your distributor of any missing items. If the equipment appears to be damaged, file a claim immediately with the carrier and notify your distributor at once, giving a detailed description of any damage. Save the damaged packing container to substantiate your claim.

ORDERING INFORMATION

Clamp-on Meter Model 607 Cat. #2139.61

Includes set of 2 color-coded silicone insulated test leads, test probes and alligator clips, hard carrying case, 4x1.5V AA batteries, Bluetooth adapter, safety information sheet and a USB stick supplied with product user manual and DataView® software.

Replacement Parts:

Hard Carrying Case **Cat. #2139.73**

Set of 2 Color-coded Silicone Test Leads, Test Probes

and Alligator Clips **Cat. #2152.05**

1 PRESENTATION

The Clamp-on Meter Model 607 is a professional electrical measuring instrument that combines the following functions:

- Current measurement
- InRush current / overcurrent (True InRush®) measurement
- Voltage measurement
- Frequency measurement
- Harmonic distortion (THD) measurement
- Harmonic rank value (A and V) up to the 25th
- Continuity test with buzzer
- Resistance measurement
- Power (W, VA, var and PF) and Energy measurements
- Crest Factor (CF), the Displacement Power Factor (DPF) and RIPPLE measurement
- Recording of data in memory; wireless transfer via Bluetooth to a PC



Item	Designation	See §
1	Jaws with centering marks (see connection principles)	3.5 to 3.13
2	Physical Guard	-
3	Rotary Function Switch	1.1
4	Function Buttons	2
5	Backlit Display	1.3
6	Input Terminals	1.4
7	Trigger	-

Figure 1: Clamp-on Meter Model 607

1.1 THE ROTARY SWITCH

The rotary switch has five positions. To access the V_{\sim} , V_{\square} , A_{\sim} , W_{\sim} functions, set the switch to the desired function. The functions are described in the table below.

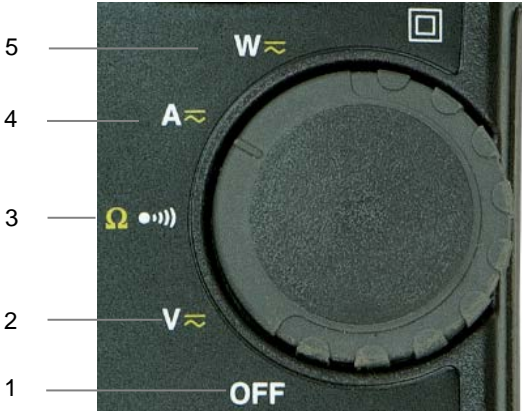

Figure 2: The Function Rotary Switch

Item	Function	See §
1	OFF mode – Turns the clamp-on meter off	3.3
2	AC, DC, AC+DC voltage measurement (V)	3.5
3	Continuity test $\bullet\bullet\bullet\bullet\bullet$)	3.6
	Resistance measurement Ω	3.7
4	AC, DC, AC+DC current measurement (A)	3.8
6	Power measurements (W, var, VA) AC, DC, AC+ DC Power factor (PF), displacement power factor (DPF), and Energy Calculation	3.10

1.2 THE FUNCTION BUTTONS



Figure 3: The Function Buttons

Item	Function	See §
1	Holds the last value on the display Zero correction $A_{DC}/A_{AC+DC}/W_{DC}/W_{AC+DC}$	2.1 3.8.2
2	Selects the type of measurement and configuration functions (AC, DC, AC+DC) Selection of single-phase or 3-phase measurement	2.2
3	Enables/disables display backlighting Scrolls up the of orders of harmonics or of pages of results in W, MAX/MIN/PEAK Enables/disables Bluetooth wireless transfer (in combination with 6)	2.3
4	Enables/disables the MAX/MIN/PEAK mode Enables/disables the True InRush® mode in A	2.5
5	Measures frequency (Hz), total harmonic distortion (THD), and orders of harmonics Enables/disables the energy metering mode	2.6
6	Scrolls down the orders of harmonics or of pages of results in W, MAX/MIN/PEAK Enables/disables recording of current data in memory Enables/disables Bluetooth wireless transfer (in combination with 3)	2.4

1.3 THE DISPLAY

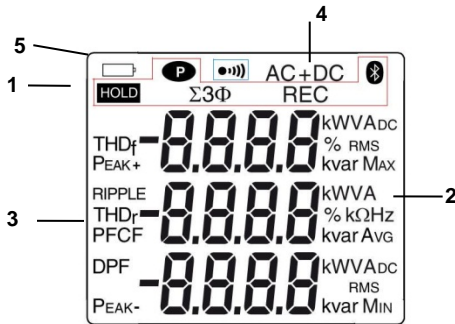





Figure 4: The Display

Item	Function	See §
1	Mode selection display	2
2	Active measurement value and unit display	3.5 to 3.13
3	Display of the MAX/MIN/PEAK modes	3.10
4	Type of measurement (AC or DC)	2.2
5	Low battery indication	5.2

1.3.1 Display Symbols

Symbol	Description
AC	Alternating current or voltage
DC	Direct current or voltage
AC+DC	Alternating and direct current
HOLD	Storage of the values and display hold
RMS	RMS value
Max	Maximum DC or RMS value
Min	Minimum DC or RMS value
AVG	Mean RMS value
PEAK+	Maximum peak value
PEAK-	Minimum peak value

$\Sigma 3\Phi$	Balanced total 3-phase power measurement
V	Volt
Hz	Hertz
W	Active power
A	Ampere
%	Percentage
Ω	Ohm
m	Milli- prefix
k	Kilo- prefix
var	Reactive power
VA	Apparent power
PF	Power factor
DPF	Displacement power factor ($\cos \phi$)
CF	Crest factor
RIPPLE	Ripple (in DC)
THDf	Total harmonic distortion with respect to the fundamental
THDr	Total harmonic distortion with respect to the true RMS value of the signal.
REC	Recording in memory
	Bluetooth wireless communication
	Continuity test
	Auto power off disabled
	Low battery indicator

1.3.2 Measurement Capacity Exceeded (OL)

The **OL** (Over Load) symbol is displayed when the display capacity is exceeded.

1.4 THE TERMINALS

The terminals are used as follows:

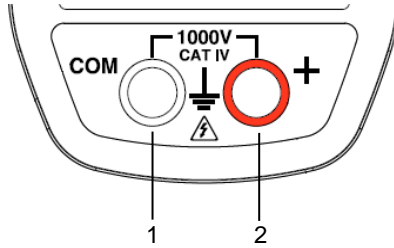



Figure 5: The Terminals

Item	Function
1	COM (black) Input Terminal Jack
2	+ Positive (red) Input Terminal Jack

2 THE BUTTONS







The buttons respond differently to short, long, and sustained presses.



In this section, the  icon represents the possible positions of the switch for the button's functionality.

2.1 BUTTON

This button is used to:

- Store and look up the last values acquired specific to each function (V, A, Ω , W) according to the specific modes previously activated (MAX/MIN/PEAK, Hz, THD). The present display is then maintained while the detection and acquisition of new values continues.
- Perform automatic zero correction in $A_{DC}/AC+DC$ and $W_{DC}/AC+DC$ (see § 3.9.2).

Successive presses on 		Function
	   	First press: Holds the last value displayed Second press: Returns to normal display mode (the value of each new measurement is displayed)
long (> 2 sec)	A_{DC} A_{AC+DC} W_{DC} W_{AC+DC}	Performs automatic zero correction (see 3.9.2) NOTE: This mode operates if the MAX/MIN/PEAK or HOLD modes (short press) are first de activated







See § 2.5.3 and § 2.6.3 for the  button functionality in combination with the  and  buttons.

2.2 (YELLOW) BUTTON (SECOND FUNCTION)

This button is used to select the type of measurement (AC, DC, AC+DC) and the second functions marked in yellow next to the relevant positions of the switch.

It can also be used to modify the default values in the configuration mode (see § 3.4).















NOTE: This button is invalid in the MAX/MIN/PEAK and HOLD modes.

Successive presses on 		Function
short	  	- Selects AC, DC or AC+DC. Depending on your choice, the screen displays AC, DC or AC+DC
		- Toggles the continuity (•••) and Ohm Ω modes
long (>2 sec)		- Displays the total 3-phase power of a balanced system ($\Sigma 3\Phi$ is displayed). Press again to return to the display of the single-phase power ($\Sigma 3\Phi$ is off)

2.3 BUTTON

This button is used to:















- Scroll up through the order of harmonics or successive pages up
- Activate the backlighting
- Activate the Bluetooth function

Successive presses on 		Function
short	  	- Scrolls through the various pages of measurement results, depending on the function and possibly the active mode (MAX/MIN/PEAK or THD/Harmonics)
long (> 2 sec)		- Enables/disables the backlighting of the display
		NOTE: The backlight turns off automatically after 2 minutes
	 	
combined with the  button		- Activates Bluetooth wireless communication
		- The  symbol is the displayed
		NOTE: Activation of the Bluetooth mode automatically stops the recording of the data
		

2.4 BUTTON

This button is used to:

- Scroll down through the orders of harmonics or successive pages
- Activate the recording of the data
- Activate the Bluetooth function

Successive presses on 		... serve
short	  	- Scrolls through the various pages of measurement results, depending on the function and possibly the active mode (MAX/MIN/PEAK or THD/Harmonics)
long (> 2 sec)	   	- Enables/disables the recording of the data - The REC symbol is then displayed NOTE: When the recording memory is full, the REC symbol flashes
combined with the  button	   	- Activates Bluetooth wireless communication - The  symbol is the displayed NOTE: Activation of the Bluetooth mode automatically stops the recording of the data











2.5 BUTTON

2.5.1 Normal Mode







This button activates the detection of the MAX, MIN, PEAK+, PEAK- or AVG values of the measurements made.

Max and Min are the extreme mean values in DC and the extreme RMS values in AC. Peak+ is the maximum instantaneous peak and Peak- is the minimum instantaneous peak.

NOTE: In this mode, the Auto Power Off function of the device is automatically disabled. The  symbol is displayed on the screen.

Successive presses on 		Function
short	 	<p>First press: Activates detection of the MAX/MIN/AVG and PEAK values and displays MAX/AVG and MIN values</p> <p>Second press: Displays the PEAK+, AVG, and PEAK- values (on a second screen)</p> <p>Third press: Displays MAX/AVG and MIN values without exiting from the mode (the values already detected are not erased)</p> <p>NOTE: Depending on the mode, AC or DC, the crest factor (CF), harmonics, frequency, and RIPPLE are also available</p>
	 	<ul style="list-style-type: none"> - Activates the detection of MAX/MIN/AVG values - Displays the MAX, MIN and AVG value successively - Returns to the display of the present measurement without exiting from the mode (the values already detected are not erased)
long (> 2 sec)	   	<ul style="list-style-type: none"> - Exits the MAX/MIN/PEAK mode. The values previously recorded are then erased <p>NOTE: If the HOLD function is enabled, it is not possible to exit from the MAX/MIN/PEAK mode. The HOLD function must first be disabled first.</p>





2.5.2 The MAX/MIN Mode + Activation of the HOLD Mode

Successive presses on 		Function
short	  	<ul style="list-style-type: none"> - Displays the MAX, AVG, MIN and PEAK+, AVG, PEAK- values detected before the  button was pressed - When the  button is pressed, the last value is held on the display

NOTE: The HOLD function does not interrupt the acquisition of new MAX, MIN, PEAK values

2.5.3 Access to the True Inrush[®] Mode (set switch to)

This button allows measurement of the True Inrush[®] current (starting current, or overcurrent in steady-state operation) for AC or DC current only (not operational in AC+DC).









Successive presses on 		Function
long (>2 sec)		<ul style="list-style-type: none"> - First press: Enters the True InRush[®] mode - "Inrh" is displayed for 3s (the backlighting blinks) - The triggering threshold is displayed for 5s (the backlighting is steady) - "-----" is displayed and the "A" symbol flashes (backlighting turns off) - After detection and acquisition, the InRush current measurement is displayed, after the calculations stage "-----" (backlighting off) <p>NOTE: The A symbol flashes to indicate "surveillance" of the signal</p> <ul style="list-style-type: none"> - Second press: Exits the True InRush[®] mode (returns to simple current measurement)
short (<2 sec) Note: A short press is functional only if a True InRush value has been detected.		<ul style="list-style-type: none"> - Displays the PEAK+ value of the current - Displays the PEAK- value of the current - Displays the RMS True InRush[®] current <p>NOTE: The A symbol is displayed during this sequence</p>

2.6 **BUTTON**





This button is used to display the frequency measurements of a signal, of power, of the levels and orders of harmonics.

NOTE: This button is not functional in the DC mode.





2.6.1 Normal Mode

Successive presses on 		Function
short		Displays: <ul style="list-style-type: none"> - The frequency of the signal, the RMS measurement, and the DC component - The crest factor CF, the RMS measurement, and the DC component
long (>2 sec)		<ul style="list-style-type: none"> - Enters or exits the THD calculation and display mode - Displays the THDf, the THDr, and the RMS value - The  and  buttons are used to display each order of harmonic (25 orders, from h01 to h25), with the associated harmonic distortion (with respect to the fundamental) and the RMS value of order hxx - NOTE: Order hdC (displayed in the DC and AC+DC modes) is the DC component; order h01 is the fundamental
		<ul style="list-style-type: none"> - Starts/Stops the energy metering mode - Displays the various energy parameters - The  and  buttons are used to display the status and energy metering measurement results pages

2.6.2 Harmonic Order Display or +

Successive presses on 		...serve
short		<ul style="list-style-type: none"> - First press: Displays the frequency of the harmonic order previously selected using the  or  buttons, instead of order hxx - Second press: Restores the display of order (hxx or hdC)

2.6.3 The Hz Function + Activation of the HOLD Mode

Successive presses on 		Function
short	 	<ul style="list-style-type: none"> - Stores and displays the frequency with the RMS value and the DC component, then on a 2nd consecutive page, the crest factor CF - NOTE: The values displayed are those measured before the  button is pressed

3 USE

3.1 INSTALLING THE BATTERIES

Insert the batteries supplied with the device as follows:

1. Using a screwdriver, unscrew the battery compartment cover (item 1) from the back of the housing.
2. Insert the 4x1.5V AA batteries supplied (item 2), observing polarities.
3. Close the battery compartment cover and screw it onto the housing.

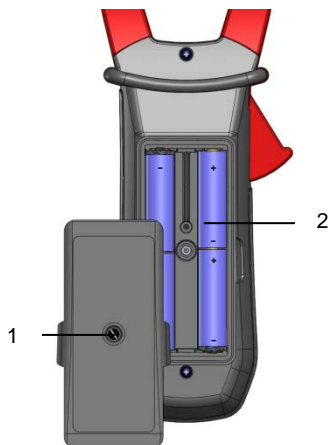

Figure 6 : The Battery Compartment

3.2 TURNING THE CLAMP-ON METER ON

- With the rotary switch set in the OFF position, turn the switch to the desired function. The display lights (all symbols) for a few seconds (see §1.3), then the screen of the function chosen is displayed.
- The clamp-on meter is now ready to make measurements.

3.3 TURNING THE CLAMP-ON METER OFF

The clamp-on meter can be turned off in two ways:





- Manually - Turn the switch to the OFF position.
- Automatically - After ten minutes with no activity, the instrument will turn OFF. Thirty (30) seconds before the device is switched off, an audible signal sounds intermittently. To re-activate the device, press any button or turn the rotary switch.

3.4 CONFIGURATION

As a safety measure, and to avoid repeated overloads on the inputs of the meter, configuration operations should only be performed when the meter is disconnected from all dangerous voltages.





3.4.1 Auto Power Off

The Auto Power Off feature is enabled by default. To disable it, perform the following:

1. In the OFF position, hold the  button down while turning the switch to  until the "full screen" display ends and a beep is emitted. The  symbol is displayed.
2. When the  button is released, the device is in the voltmeter function in the normal mode.
3. To return to Auto Power Off, turn the clamp-on meter OFF and then back ON again.

3.4.2 Configuring the Current Threshold for True InRush[®] Measurement



To configure the triggering current threshold of the True InRush[®] measurement:

1. In the OFF position, hold the  button down while turning the switch to  until the "full screen" display ends and a beep is emitted. The display will indicate the percentage overshoot to apply to the measured current to determine the measurement triggering threshold.
The value stored by default is 10%, representing 110% of the established current measured. The possible values are 5%, 10%, 20%, 50%, 70%, 100%, 150%, and 200%.
2. To change the threshold, press the  (yellow) button. The value flashes; each press on the  (yellow) button displays the next value. To record the chosen threshold, apply a long press (>2s) on the  (yellow) button. A confirmation beep is emitted.



To exit from the configuration mode, turn the switch to another setting. The chosen threshold is stored and a double beep is emitted.

NOTE: The starting (InRush) current measurement triggering threshold is fixed at 1% of the least sensitive range. This value is 1% of 99.99A or 1A. This threshold is not adjustable.

3.4.3 Configuring the Recording Duration

1. In the OFF position, hold the  (yellow) button down while turning the switch to , until the end of the "full screen" display and the emission of a beep, to enter the configuration mode. The display will then indicate the recording interval.



NOTE: The default value is 60 seconds. Possible values range from 1 second to 600 seconds (10 minutes).

2. To change the recording interval, press the  (yellow) button. The right-hand digit blinks. Each press on the  (yellow) button increments its value. To go to the next digit, apply a long press (>2s) to the  (yellow) button.
3. When the desired unit is displayed, turn the switch to another setting. The unit chosen is stored and a double beep is emitted.

3.4.4 Erasing Recordings from Memory



To erase a recording from memory, perform the following:

NOTE: Make sure there is no voltage on the input terminals.

1. In the OFF position, hold the  (yellow) button down while turning the switch to .
2. The device emits a beep after erasing the records in memory. The "rSt" and "rEC" symbols are displayed.
3. The device then switches to normal continuity measurement.

3.4.5 Default Configuration

To reset the clamp-on meter to its default parameters (factory configuration):

1. In the OFF position, hold the  (yellow) button down while turning the switch to , until the "full screen" display ends and a beep is emitted. The "rSt" symbol is displayed.
2. After 2 s, the clamp-on meter emits a double beep, then all of the digital symbols of the screen are displayed until the  (yellow) button is released. The default parameters are then restored:
 - Recording interval = 60 seconds
 - Continuity detection threshold = 40Ω
 - True InRush triggering threshold = 10%

3.5 VOLTAGE MEASUREMENT (V)

To measure voltage, proceed as follows:

1. Set the switch to **V_~**.
2. Connect the black lead to the **COM** terminal and the red lead to the **"+"** terminal.
3. Connect the test probes or the alligator clips to the circuit to be measured. The device selects AC or DC automatically according to which measured value is larger. The AC or DC symbol displays blinking in auto detect mode.

To select AC, DC or AC+DC manually, press the **⏏** (yellow) button to toggle between them. The symbol corresponding to the choice will then display.

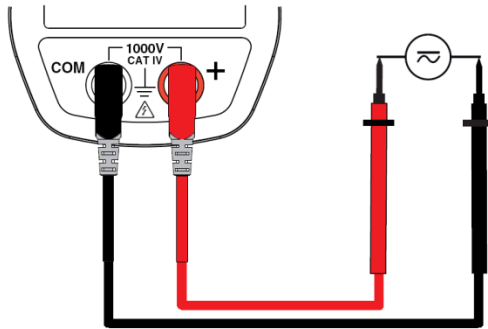

The measured value is displayed:

In DC

Display	Quantity
1 st row	Voltage V RMS
2 nd row	DC RIPPLE in %
3 rd row	DC voltage component, V _{DC}

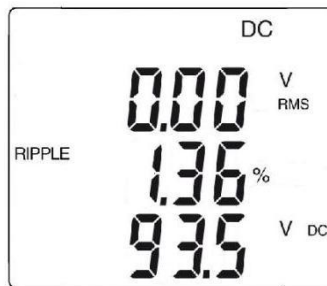

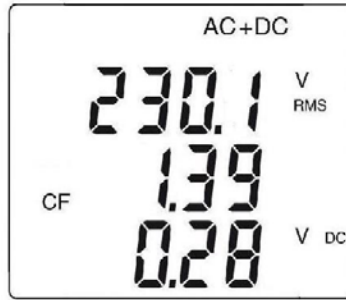

In AC and AC+DC

Display	Quantity
1st row	Total RMS voltage V RMS or TRMS
2nd row	Crest factor (CF)
3rd row	DC voltage component, VDC



3.6 CONTINUITY TEST

Warning: Before performing the test, make sure that the circuit is off and all capacitors have been discharged.

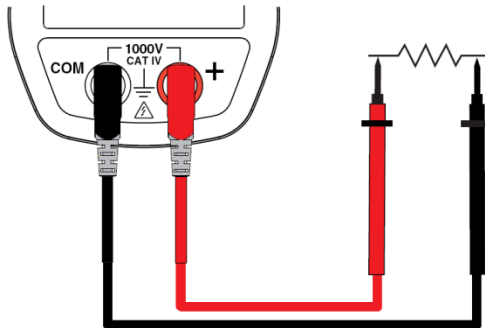

1. Set the switch to  ; the  symbol is displayed.
2. Connect the black lead to the **COM** terminal and the red lead to the "+" terminal.
3. Connect the test probes or the alligator clips to the circuit or component to be measured.



An audible signal is emitted if there is continuity and the measured value is displayed on the screen.

3.7 RESISTANCE MEASUREMENT Ω

Warning: Before making a resistance measurement, make sure that the circuit is off and all capacitors have been discharged.

1. Set the switch to  and press the  (yellow) button. The Ω symbol is displayed.
2. Connect the black lead to the **COM** terminal and the red lead to the **"+"** terminal.
3. Connect the test probes or the alligator clips to the circuit or component to be measured.

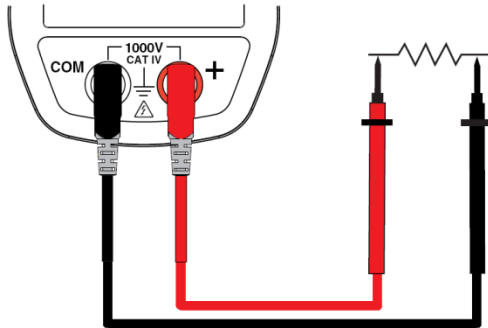

The measured value is displayed on the screen.

3.8 CURRENT MEASUREMENT (A)



The jaws are opened by pressing the trigger on the body of the meter. The arrow on the jaws of the clamp-on meter (see the following diagram) should point in the presumed direction of current flow, from the generator to the load. Make sure that the jaws have closed correctly after clamping around the conductor.

NOTE: The measurement results are optimal when the conductor is centered in the jaws (aligned with the centering marks).

The device selects AC or DC automatically according to which measured value is larger. The AC or DC symbol displays blinking in auto detect mode.

3.8.1 AC Measurement

For an AC current measurement, proceed as follows:

1. Set the switch to  and select AC by pressing the  (yellow) button). The AC symbol is displayed.
2. Clamp the jaws around the conductor to be measured. The device selects AC or DC automatically.

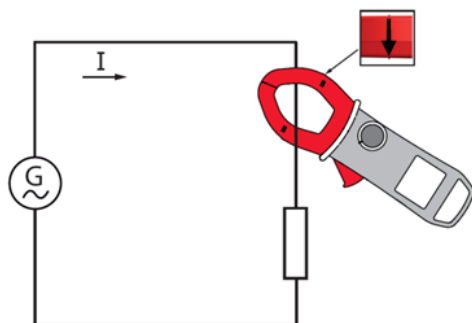

The measured values are displayed on the screen.

Display	Quantity
1st row	RMS current A RMS
2nd row	Crest factor (CF)
3rd row	DC current component Adc



3.8.2 DC or AC+DC Measurement

Set the switch to **A \approx** and select DC if the display does not indicate "0"; the DC zero must be corrected first.



Step 1: Correction of DC Zero

Important: The clamp must not be closed on the conductor during the DC zero correction. Hold the clamp in the same position during the whole procedure so that the correction value will be exact.

Press the **HOLD** button until the device emits a double beep and displays a value near "0". The correction value is stored until the clamp is powered down.

NOTE: The correction is effected only if the value displayed is $< \pm 20A$, otherwise the value displayed blinks and is not stored. The clamp must be recalibrated (see § 5.3)

Step 2: Make a Measurement

1. The switch is set to **A** . Select DC or AC+DC by pressing the  (yellow) button until the desired choice is reached.
2. Clamp the jaws around the conductor to be measured.

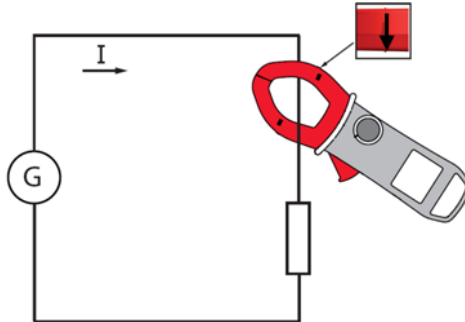

The measured values are displayed:

In DC:

Display	Quantity
1st row	Current A RMS
2nd row	DC RIPPLE in %
3rd row	DC current component A _{DC}

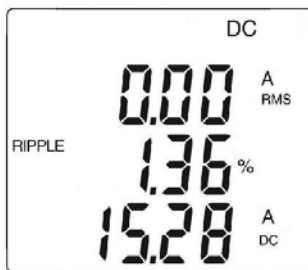

In AC and AC+DC:

Display	Quantity
1st row	Total RMS current in A RMS or TRMS
2nd row	Crest factor (CF)
3rd row	DC current component Adc

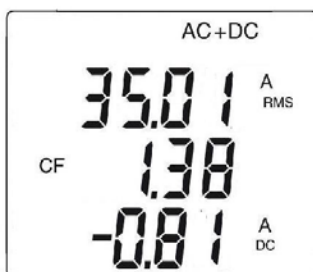

3.9 STARTING CURRENT OR OVERCURRENT (True InRush®) MEASUREMENT

NOTE: The measurement can be made only in AC or DC mode (AC+DC mode disabled).

To measure a starting current or overcurrent, proceed as follows:

1. Set the switch to **A_~**, correct the DC zero (see §3.9.2), then clamp the jaws around the conductor to be measured.
2. Perform a long press on the **MAX/MIN PEAK** button. The **InRh** symbol is displayed, along with the triggering threshold. The clamp then awaits detection of the True InRush® current. "-----" is displayed and the A symbol flashes.
3. After detection and acquisition for 100 ms, the RMS value of the True InRush® current is displayed. Pressing the **MAX/MIN PEAK** button will display the PEAK+/PEAK- values subsequently.
4. A long press on the **MAX/MIN PEAK** button or a change of function on the rotary switch will exit the True InRush® mode.

NOTE: The triggering threshold in A is 20A if the initial current is zero (starting of installation). For an established current (overload in an installation) see §3.4.2.

Display	Quantity
1st row	"Inrh"
2nd row	True Inrush value in A
3rd row	Triggering threshold in A

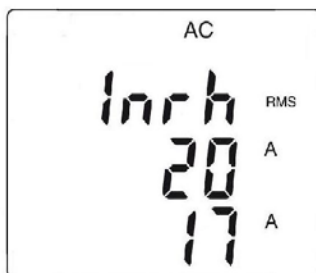

PEAK:

Display	Quantity
1st row	"lnrh"
2nd row	PEAK+ or PEAK- value in A
3rd row	Triggering threshold in A

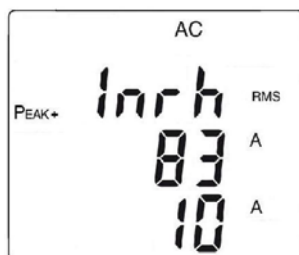

3.10 POWER MEASUREMENTS W, VA, VAR AND PF

This measurement is possible in single-phase or in balanced 3-phase.

NOTE: If performing DC or AC+DC power measurements, correct the DC zero in current first (see § 3.8.2)

For the power factor (PF) and VA and var, the measurements possible are only available in AC or AC+DC modes.

3.10.1 Single-Phase Power Measurement

1. Set the switch to **W** and select **VA**, **var**, or **PF** by pressing the **Hz** button until the desired choice is reached.
2. The device automatically displays **AC+DC**. To select AC, DC, or AC+DC, press the **Yellow** (yellow button) until the desired choice is reached.
3. Connect the black lead to the **COM** terminal and the red lead to the **+** terminal.
4. Connect the test probes or the alligator clips of the black lead on the neutral (N), then those of the red lead on the L phase.
5. Clamp around only the corresponding conductor, respecting the direction.

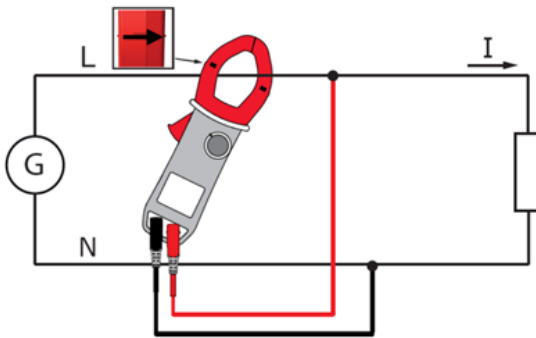

The measurement is displayed on screen.

Display	Quantity
1st row	Active power W (DC, AC or AC+DC)
2nd row	Reactive power var (AC or AC+DC)
3rd row	Apparent power VA (AC or AC+DC)



3.10.2 Balanced 3-Phase Power Measurement

1. Set the switch to **W \approx** .
2. Press the **⏏** (yellow) button until the $\Sigma 3\Phi$ symbol is displayed.
3. The device automatically displays **AC+DC**. To select AC, DC, or AC+DC, press the **⏏** (yellow) button until the desired choice is reached.
4. Connect the black lead to the **COM** terminal and the red lead to the **"+"** terminal.
5. Connect the leads and the clamp to the circuit as follows:

If the red lead is connected...	...and the black lead is connected	...then the clamp is on the conductor
To the L1 phase	to the L2 phase	of the L3 phase
To the L2 phase	to the L3 phase	of the L1 phase
To the L3 phase	to the L1 phase	of the L2 phase

NOTE: The arrow on the jaws of the clamp (see the diagram below) must point in the presumed direction of flow of the current from the source (producer) to the load (consumer).

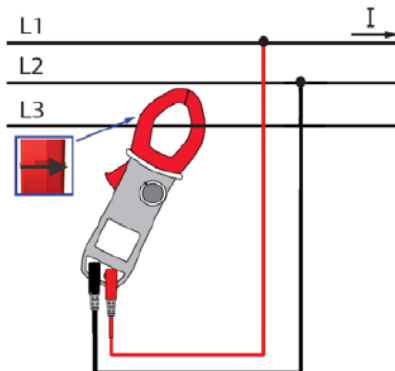

The measurement is displayed on screen.



NOTE: 3-phase power on a balanced 4-wire network can also be measured by proceeding in the same way, or by proceeding as for the measurement on a single-phase network, then multiplying the value by three.

3.10.3 Four Quadrant Diagram

In order to correctly determine the sign of the active and reactive powers, refer to the diagram below, which determines:

- positive active power (W) = power consumed
- negative active power = power generated
- reactive power (var) and active power of the same sign = inductive power
- reactive power and active power of opposite signs = capacitive power

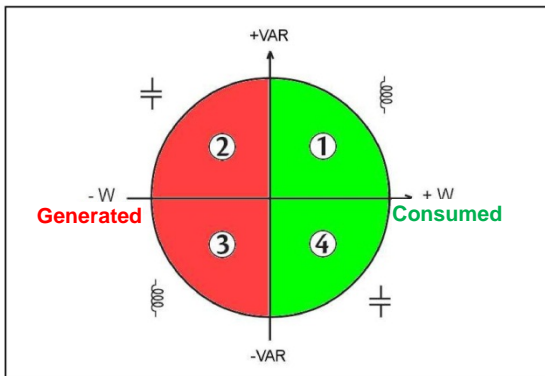

3.11 ENERGY METERING MEASUREMENT

The Energy Metering measurement is available in W for the AC and AC+DC quantities.

The energy meters start and totalize the various types of energy (the eight energy meters - 4 meters of energy consumed and 4 meters of energy generated - are started).

To measure the energy metering, proceed as follows:

1. Set the switch to **W_~**.
2. Press the **Hz** (long press). Start-up screen 1 in the Energy Metering mode appears. The display reads "Counting Off".



3. Connect the black lead to the **COM** terminal and the red lead to the "+" terminals.
4. Place the test probes or the alligator clips of the black lead on the neutral (N), then those of the red lead on the L phase.
5. Clamp around only the corresponding conductor, respecting the direction of current flow (see §3.10).
6. To start the metering, press the **Yellow** (yellow) button. The display reads "Counting On".

The metering sequence is as follows:

1-0n ---> StOp ---> OFF ---> |

|<----->|

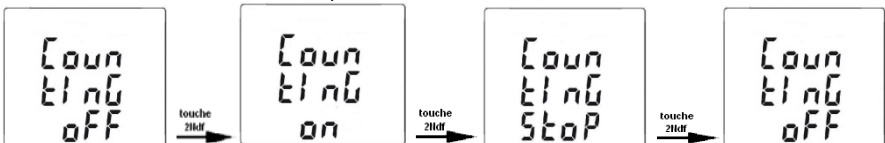

The status of each meter is:

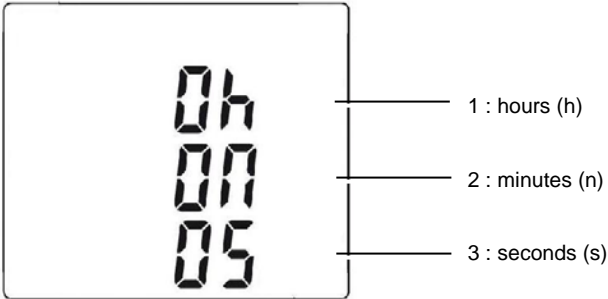

- On <=> metering in operation
- Off <=> metering stopped (values of the meters 0)
- Stop <=> metering stopped (values of the meters preserved)

Hour meter page:



The duration of the metering uses the following format: XXXh (for hours) XXm (for minutes) XXs (for seconds)

NOTE: Beyond 999h 59m 59s "---h--m--s" is displayed, but the internal metering duration keeps running correctly.

View of the set of screens concerning Energy measurement by short presses on  or  buttons:

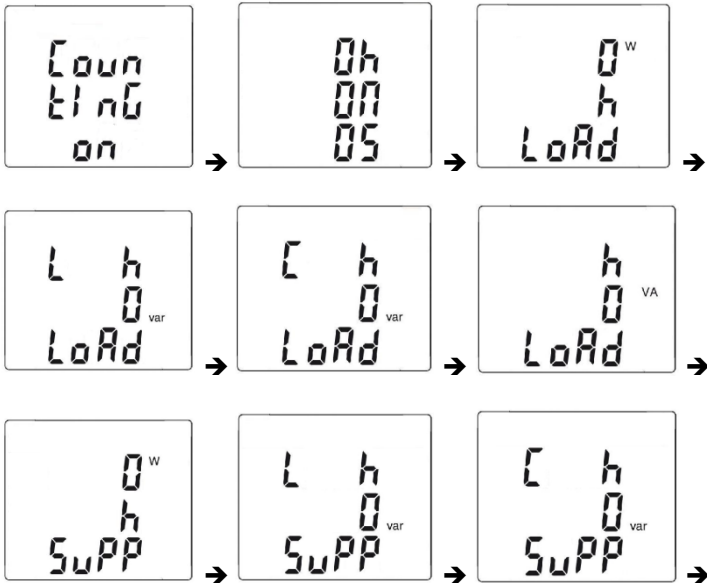

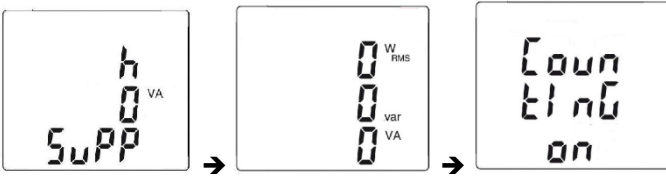

Conventions:

- Load designates the consumed energy by the load (W+)
- Load C designates the capacitive reactive energy (W+ and var-)
- Load L designates the inductive reactive energy (W+ and var+)
- Supp designates the energy generated by the load (W-)
- Supp C designates the capacitive reactive energy (W- and var-)
- Supp L designates the inductive reactive energy (W- and var+)

7. To access the screens concerning the energies received by the load (« Load side »), press the  button to view each screen that has the term "LoAd at the bottom of the screen.

The sequence of use is as follows:

I - Load h W ---> Load L h VAR ---> Load C h VAR ---> Load h VA ---> I
 | <-----|

Example of « LOAD side » screen

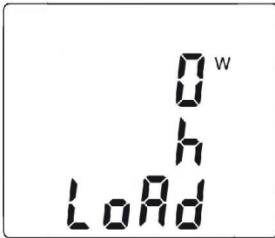

8. To access the screens concerning the energies generated by the load and therefore received by the source ("Supply side"), press the  button to view the screens that have the term "SuPP at the bottom of the screen.

The sequence of use is as follows:

I - Supp h W ---> Supp L h VAR ---> Supp C h VAR ---> Supp h VA ---> I
 | <-----|

Example of « SUPP side » screen



The energy displays use the following formats:

- [000.1 ; 999.9]
- [1.000 k ; 9999 k]
- [10.0 M ; 999 M]
- [1.00 G ; 999 G]

3.12 FREQUENCY MEASUREMENT (HZ)

The frequency measurement is available in **V**, **W** and **A** for AC and AC+DC measurements. The measurement is based on a count of zero crossings (positive-going edges).

3.12.1 Frequency Measurement (V)

To measure the frequency in voltage, proceed as follows:

1. Set the switch to **V_~** and press the **Hz** button. The **Hz** symbol is displayed.
2. Select AC by pressing the **Hz** (yellow) button until the desired choice is reached.
3. Connect the black lead to the **COM** terminal and the red lead to the **+** terminal.
4. Connect the test probes or the alligator clips to the circuit to be measured.

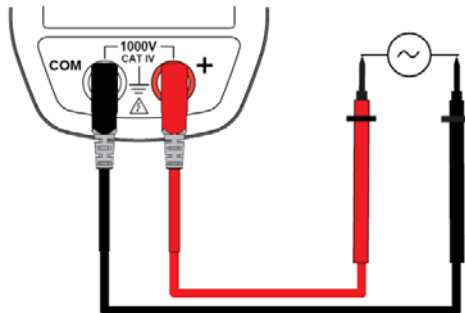

The measured value is displayed on the screen.

3.12.2 Frequency Measurement (A)

1. Set the switch to **A** and press the **Hz** button. The **Hz** symbol is displayed.
2. Select AC or AC+DC by pressing the **Yellow** (yellow) button until desired choice is reached.
3. Clamp the jaws around the conductor to be measured.

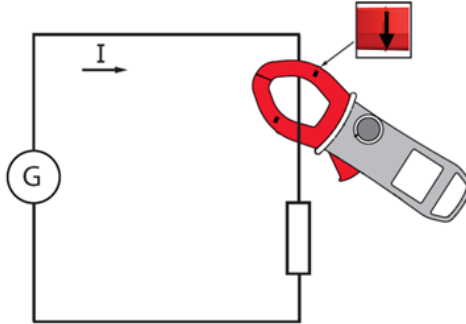

The measured value is displayed on the screen.

3.13 MEASUREMENT OF THE TOTAL HARMONIC DISTORTION (THD) AND DISPLAY OF THE ORDER OF HARMONICS ORDER

The device measures the total harmonic distortion with respect to the fundamental (THD_f), the total harmonic distortion with respect to the true RMS value of the signal (THD_r) in voltage and in current, then the level (with respect to the fundamental), frequency, and RMS value of each order of harmonic.

The frequency of the fundamental is determined by digital filtering and FFT for the network frequencies of 50, 60, 400, and 800Hz.

3.13.1 Measurement of the THD (V)

1. Set the switch to **V** and press and hold (>2s) the **Hz** button. The **THD_f**, **THD_r**, and **V RMS** symbols are displayed.
2. Connect the black lead to the **COM** terminal and the red lead to the **+** terminal.
3. Place the test probes or the alligator clips on the terminals of the circuit to be measured.

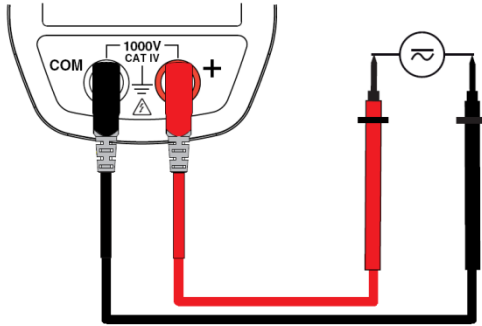

The measurement is displayed on screen.

3.13.2 Measurement of the THD (A)

1. Set the switch to **A** and press and hold (>2s) the **Hz** button. The **THD_f**, **THD_r** and **A RMS** symbols are displayed.

NOTE: first press the yellow button to place the meter in AC current measurement mode.

2. Apply the clamp to only the conductor concerned.

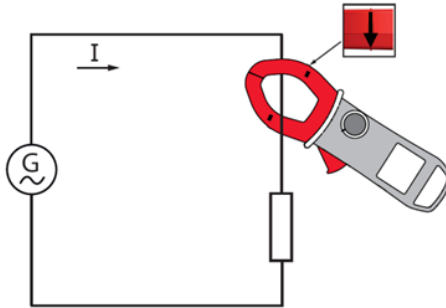

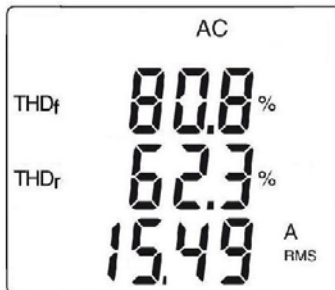

The measurement is displayed on screen.



3.13.3 Display of the Individual Harmonics and of the Frequency of the Fundamental From DC to the 25th.

In the context of measurement of the THDs in voltage (§ 3.13.1) and in current (§ 3.13.2):

1. Press the  button. Order “**hdC**” is displayed (DC component), only in DC or AC+DC. The harmonics of higher orders are displayed sequentially as the  button is pressed repeatedly. The  button can be pressed to return to the previous order.

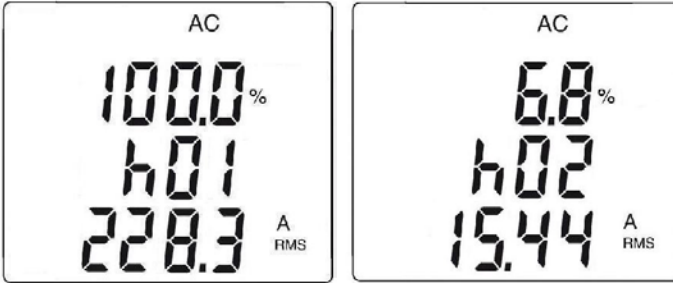

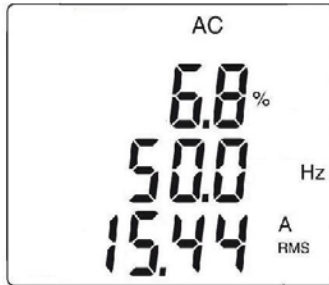

2. The  button can be pressed to display the frequency of the order of harmonic concerned.



3.14 RECORDING OF MEASUREMENTS

The power meter allows recording of the data/measurements using the REC function. The default recording interval is 60 seconds. It can be configured (see §3.4.3) from 1 second to 600 seconds (10 minutes).

1. First, select the function to be measured using the rotary switch, then apply a long press (> 2s) to the  button. The **REC** symbol is displayed. Recording of the measurement starts. The data recorded is in the format: "MAX value – AVG Value – MIN Value – Unit – Mode" (AC or AC+DC).
NOTE: The meter does not record pure DC measurements
2. To stop recording, apply a long press (>2s) to the  button. The **REC** symbol disappears.

NOTE: Recording is interrupted automatically when the memory of the device is full (REC symbol is flashing) or Bluetooth wireless communication is activated (§3.15)

Type of data	Max. number of records	Max. recording time at 1s intervals	Max. recording time at 600s intervals (10 mn)
V, A, Ω	1000	16 minutes	160 hours
W	200	3 minutes	35 hours
THD	300	5 minutes	55 hours
Harmonics	470	8 minutes	80 hours

3.15 CONNECTING TO A COMPUTER

3.15.1 Bluetooth Connection

The Model 607 is equipped with Bluetooth connectivity for downloading displaying and deleting recorded data in the instrument's memory.





The instrument is supplied with a Bluetooth USB adapter for use with computers without Bluetooth capability. If this is the case, connect the adapter to an available USB port on your computer. The default Windows driver will automatically install the device.

The instrument must be paired to the computer before connecting to the software. The pairing procedure varies depending on your operating system, Bluetooth equipment and driver software.

NOTE: The information in the following sections are only necessary the first time an instrument is connected, or when the Bluetooth USB adapter has been removed then reconnected.

3.15.2 Pairing the Instrument to the Computer

The following steps are for pairing using Windows Vista/Windows 7:

1. In the active measurement function, press the  and  buttons simultaneously. The  symbol will appear in the upper right corner of the display.
2. Connect the supplied Bluetooth USB Adapter into an available USB port. Windows will install any necessary drivers automatically.
3. A Bluetooth symbol, similar to this , will appear in the system tray at the bottom of your screen once the driver is installed.
4. Right click on the icon and select “Add a Device”.
5. In the “Add a Device” window, select the instrument you wish to connect to and select “**Next**”.



NOTE: Depending on the Bluetooth setup and operating system, it may be necessary to enter a passkey to finalize the instrument connection. If so, the default passkey is: **0000**.

1. If asked for a pairing code select the **“Enter the Device’s pairing code”**.

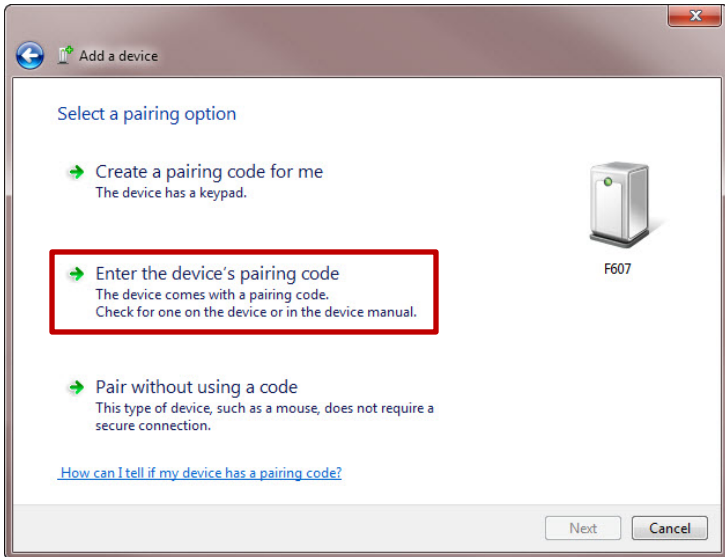

2. Enter the pairing code as shown below and select **“Next”**

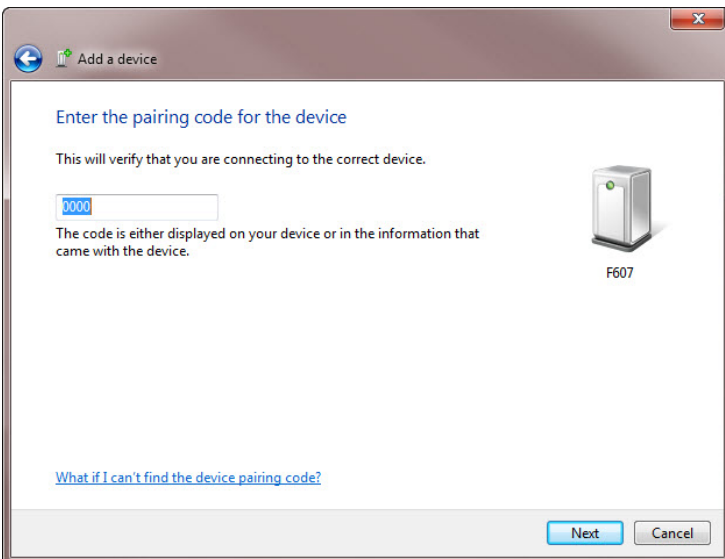

3. Once the instrument has been successfully added to the computer, a window similar to the one below will be displayed. Select “Close”.

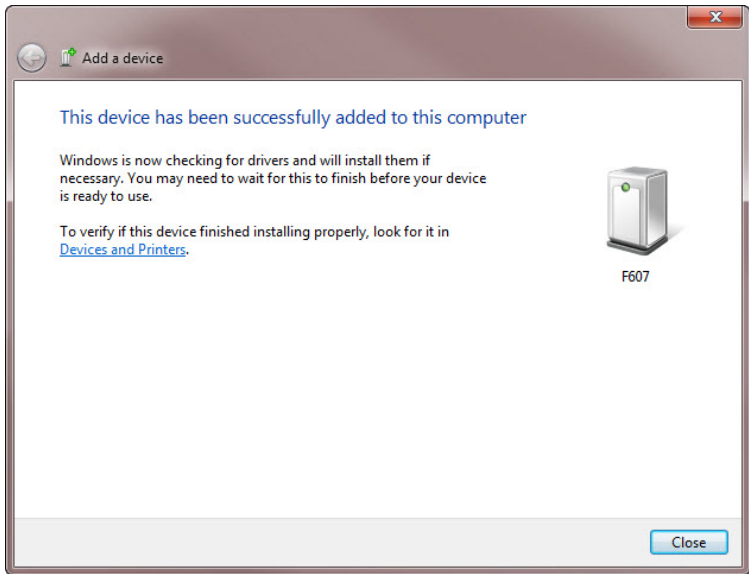



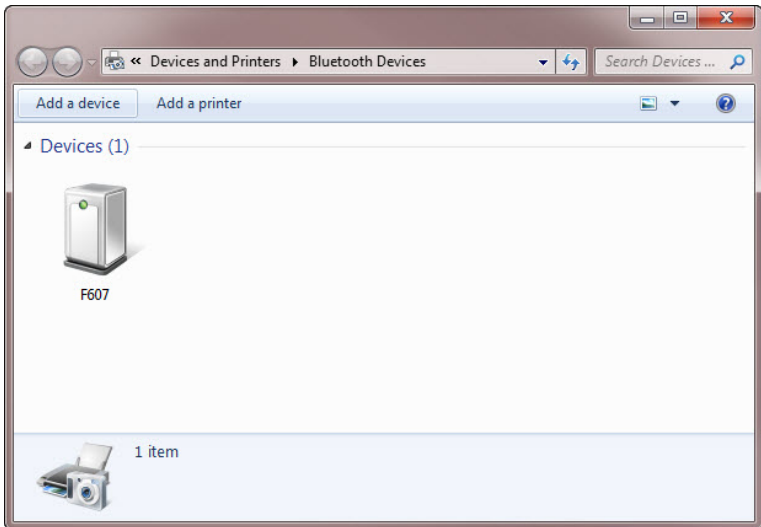



4. You should see the Device listed in the Bluetooth devices window.



1. Launch the DataView® Control Panel using the icon placed on the desktop during software installation. Refer to section 3.22 for DataView® software installation. The instrument should automatically connect if only one power meter is paired. If more than one instrument is paired, select the instrument you wish to connect to from the drop-down list in the connection window.
2. Selecting OK will establish the connection between the power meter and the DataView® software. It is now possible to view the instrument status and downloaded data. If data is present in the instrument's memory, the software will automatically start downloading once connected.

3.16 TURNING BLUETOOTH ON/OFF

The Bluetooth can only be turned on or off when the instrument is not recording. To enable the Bluetooth press the  and  keys simultaneously. The  symbol should be displayed in the upper right corner of the display. To disable Bluetooth press the  and  keys simultaneously the  symbol will turn off.

3.17 RECORDING DATA

3.17.1 Starting a Recording Session

NOTE: A new recording cannot be started if the memory is full or if the Bluetooth is active.

1. Configure the instrument as described in section 3.4.
2. Select the measurement function to be recorded using the rotary switch and connect the instrument to the measurement source
3. Press the REC button for >2s to start a recording.
4. The REC indication will remain solid when there is available memory or it will blink if the memory is full.
5. If the memory is partially full then it is possible to start another recording. The duration of the recording will depend on the available memory.

3.17.2 Stopping a Recording Session

1. Press and hold the REC button for >2s
2. The REC indication will not be displayed if a recording is not active.

3.18 DOWNLOADING RECORDED DATA

Recorded measurements stored in the instrument are transferred to a computer via the download command in the DataView® Control Panel.

3.19 ERASING DATA FROM MEMORY

Erasing data from the instrument's memory can be performed in two ways.

Erasing the Memory using the  YELLOW button and rotary switch:

1. Turn the instrument "OFF".
2. Press and hold the YELLOW button while rotating the rotary switch to the "Ω" position.
3. Release the YELLOW button when **RST REC** is displayed to erase the memory.

Erasing the Memory using the DataView® Control Panel:

1. Connect the instrument to the computer and launch the Power Clamp Meter Control Panel.
2. Select View Recorded Data from the Instrument menu.
3. In the "Recorded Data in Instrument" window select the "Select All" button and click on "Delete All" to erase the memory.

3.20 DATA STORAGE

The Model 607 captures Trend measurements at a user specified interval.

The approximate number of data points that can be recorded with the memory cleared

3.20.1 Trend Measurements

The Model 607 stores the measurement of each of the inputs. In addition, the user can define the storage rate and type of measurement.

3.20.2 Recording with Memory Cleared

When a recording starts, the power meter will continue to record until one of the following occurs:

- The memory becomes full.
- A manual press of the REC button for >2s is performed.
- The battery voltage is not sufficient to keep the instrument powered.

3.20.3 Recording with a Partial or Full Memory

It is possible to have more than one recording provided there is sufficient memory. The duration of the additional recording will depend on the sample rate of the recording, amount of memory left and type of recording.

3.20.4 Memory Filled During Recording Session

If the memory becomes full, the **REC** indication on the display will blink. It will be necessary to download and erase the memory before a new recording can be started.

3.21 SOFTWARE INSTALLATION

3.21.1 Installing DataView®

USB Flash Drive Install

1. Insert the USB stick into an available USB port (wait for driver to be installed).
2. If Autorun is enabled then an AutoPlay window should appear as shown.).
3. A Set-up window will appear.

NOTE: If Autorun is disabled, it will be necessary to open Windows Explorer, then locate and open the USB stick drive labeled “DataView” to view the files on the drive.

4. In the AutoPlay window, select “Open folder to view files”.
5. Double-click on Setup.exe from the opened folder view to launch the DataView setup program. A Set-up window, similar to the one below, will appear.

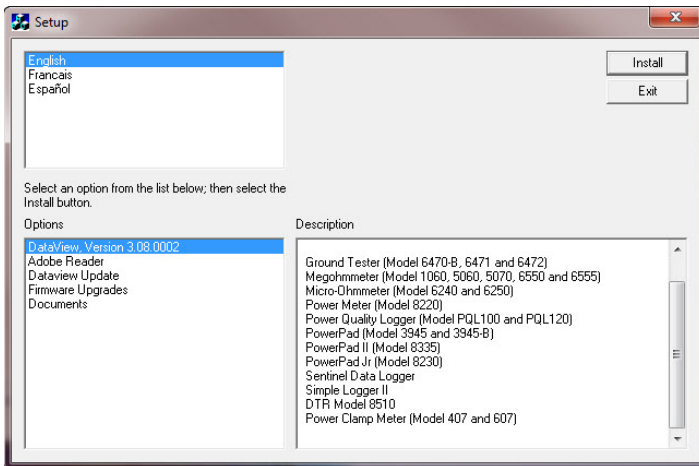

There are several different options to choose from. Some options^(*) require an internet connection.

- **DataView, Version x.xx.xxxx** - Installs DataView[®] onto the PC.
 - ***Adobe Reader** - Links to the Adobe[®] website to download the most recent version of Adobe[®] Reader to the computer. *Adobe[®] Reader is required for viewing PDF documents supplied with DataView[®].*
 - ***DataView Updates** - Links to the online DataView[®] software updates to check for new software version releases.
 - ***Firmware Upgrades** - Links to the online firmware updates to check for new firmware version releases.
 - **Documents** - Shows a list of instrument related documents that you can view. Adobe[®] Reader is required for viewing PDF documents supplied with DataView[®].
6. DataView, Version x.xx.xxxx option should be selected by default. Select the desired language and then click on Install.
 7. The Installation Wizard window will appear. Click Next.
 8. To proceed, accept the terms of the license agreement and click Next.
 9. In the Customer Information window, enter a Name and Company, then click Next.
 10. In the Setup Type window that appears, select the "Complete" radio button option, then click Next.
 11. In the Select Features window that appears, select the instrument's control panel that you want to install, then click Next.

NOTE: The **PDF-XChange** option must be selected to be able to generate PDF reports from within DataView[®].

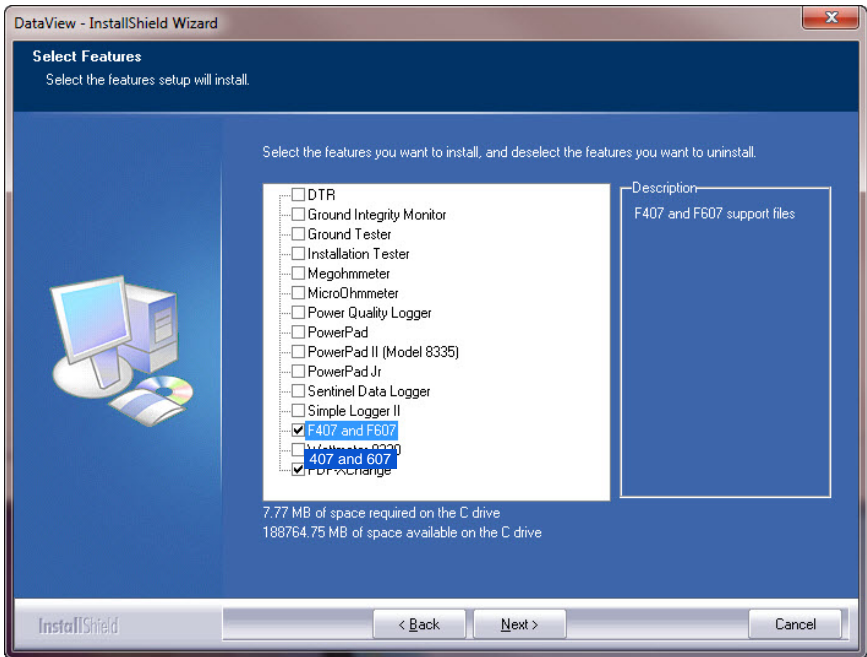

12. In the Ready to Install the Program window, click on Install.
13. If the instrument selected for installation requires the use of a USB port, a warning box will appear, similar to below. Click **OK**.



NOTE: The installation of the drivers may take a few moments. Windows may even indicate that it is not responding, however it is running. Please wait for it to finish.

14. When the drivers are finished installing, the Installation Successful dialog box will appear. Click **OK**.
15. Next, the Installation Wizard Complete window will appear. Click **Finish**.
16. A Question dialog box appears next. Click **Yes** to read the procedure for connecting the instrument to the USB port on the computer.

NOTE: The Setup window remains open. You may now select another option to download (e.g. Adobe® Reader), or close the window.

- Restart your computer, then pair the instrument to the computer as described in section 3.15.

Shortcuts for DataView® and each instrument control panel selected during the installation process have been added to your desktop.

3.22 OPENING THE DATAVIEW CONTROL PANEL

To open the Power Meter Control Panel:

- Double-click the **icon** that was created during installation, located on the desktop.
- The **Connection** window appears.

NOTE: If only one power meter is connected to the computer, it will be selected and a connection will be established automatically.

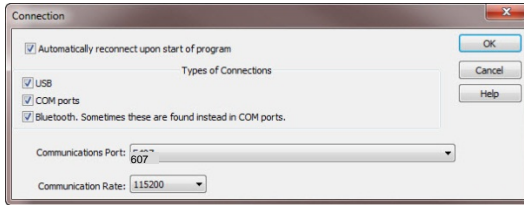

The **Connection** window lists the connected instrument in the Instrument drop-down list.

If multiple units are attached, select the desired unit.

Once the desired instrument has been selected, click **OK** and the **Control Panel** will attempt to connect to the instrument and download any data.

NOTE: The default layout can be changed by moving and resizing each window.

3.23 USING THE CONTROL PANEL

The **Control Panel** is used to view the instrument status, download, view and erase the memory. It is also used to generate reports in DataView® and export the recorded data into an excel format.

To open the Control Panel, either click on the **Control Panel** option from DataView's **Instrument** menu or select the control panel icon placed on the desktop during the installation.

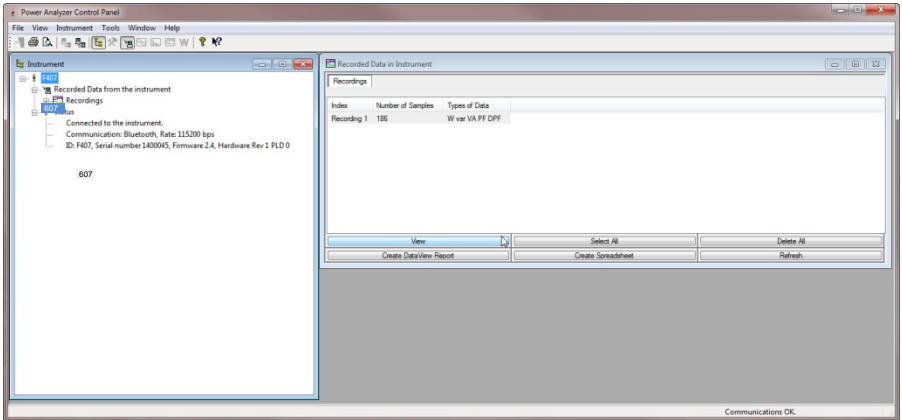

The main menu at the top of the screen lists the following commands:

File

- **Open**
- **Save As**
- **Create DataView Report**
- **Create Spreadsheet**
- **Edit Session Properties**
- **Print** - prints the selected real-time window.
- **Print Preview** - provides a preview of the real-time window to be printed.
- **Print Setup** - displays a Print Setup window allowing you to select a destination printer and change various printing options.
- **Exit** - closes the control panel.

View

- **Trend** – N/A
- **Waveform** – N/A
- **Harmonic** – N/A
- **Power** – N/A
- **Toolbar** – Basic<->Advanced – Displays or hides the toolbar icons commonly used or shows all icons
- **Status Bar** – Shows the toolbar at the bottom of the control panel window which displays connection status
- **Status Screen** – Opens a window that displays the instrument status

Instrument

- **Connect** - establishes a connection.
- **Disconnect** - closes a connection.
- **Configure** – N/A
- **View Recorded Data** – Open a window to display the recordings present in the instrument.
- **Download All Recorded Data** – Downloads the instruments memory to the PC
- **Set Clock** – N/A

Tools

- **Colors** - allows the user to specify the default colors to be assigned to graph traces associated with specific trend measurements and change the graph background color.
- **Options** - allows the user to specify default parameters when displaying data.
- **Recover Data** - allows the user to load an instrument specific .icp file.

Window

- **Cascade** - arrange all windows into a stack, with each window offset slightly.
- **Tile** - display all windows equally sized without overlapping.
- **Load Layout** - Loads a user saved layout
- **Save Layout** – Allows the user to save a custom layout for later use.
- **Restore Default Layout** – Arranges the windows to a default layout.

NOTE: In addition, a list of open real-time windows is displayed at the bottom of the Window menu. Selecting one of these options will activate the associated real-time window. This is useful when other windows hide a desired window.

Help

- **Help topics** - display the main Control Panel help topic.
- **Help About** - displays the About dialog box.

3.24 DISPLAYING REAL-TIME STATUS INFORMATION

Downloaded data and instrument status is displayed in the **Control Panel**.

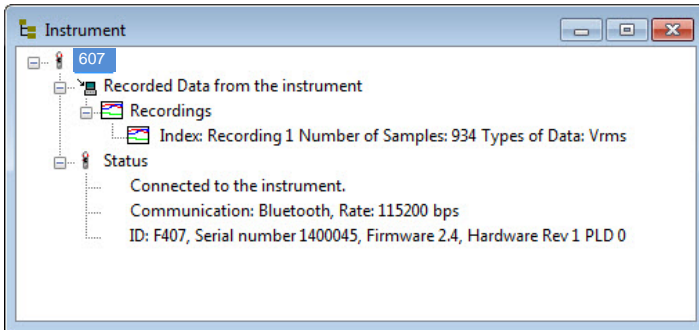

Figure 4-10

Recorded Data from the Instrument

Status:

- **Connection** - shows if instrument is connected/disconnected
- **Model** - instrument's model identification number
- **Communication** – shows connection type and baud rate
- **ID** – displays the Model, Serial #, Firmware and Hardware Version

3.25 RESIZING AND SAVING REAL-TIME WINDOW LAYOUTS

The windows can also be resized and arranged to suit your needs by using the mouse pointer. To move a window, simply click and hold on the title bar, then drag to the desired location. To resize a window, click and drag the corner of the window.

Once you have all of your windows in a desired location, you can save your layout for future use.

To Save a Layout:

- Go to **Window > Save Layout**. Type in a name for the layout and select the folder that you wish to save it in. Click on **Save**.

To Load a Layout:

- Go to **Window > Load Layout**. Locate and select a previously saved layout file. Click on **Open**.

3.26 DOWNLOADING RECORDED INSTRUMENT DATA

Recorded measurements stored in the instrument are transferred to a computer via the download command in the Control Panel. Assuming a recording session has been started and stopped, the instrument should have at least one recorded measurement inside it.

To Download a Recording:

- Select **Download All Recorded Data** from the **Instrument** menu. This begins the transfer of recorded data to the computer. A window displaying the transfer progress will be displayed.

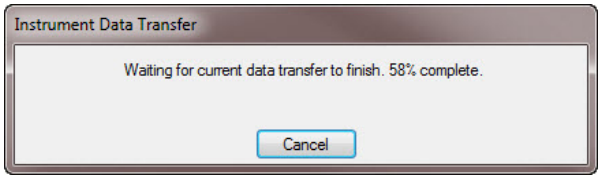

- Once the transfer is complete, a **Date/Time** window appears. Enter the Date and start time of the recording. Note: This can be changed at a later time using the Recording Parameter button in the viewed data window.

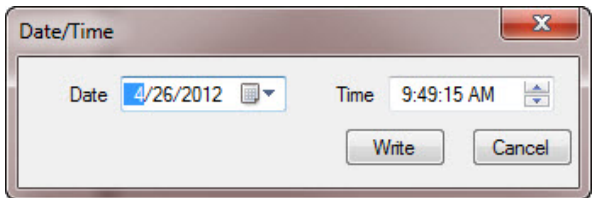

- Once a Date/Time is written, the **Recorded Data in Instrument** window will display the recording. To display the data in a graph or list format, select the desired recording and select **View**.

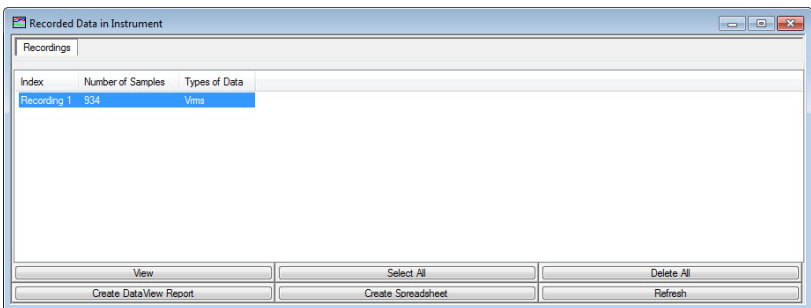

- From the "View" window you can select what to view using the radio buttons and view the data in a list format by selecting the **"View as List"** checkbox. There are other options to Print the data directly, export to excel or Create a DataView report.

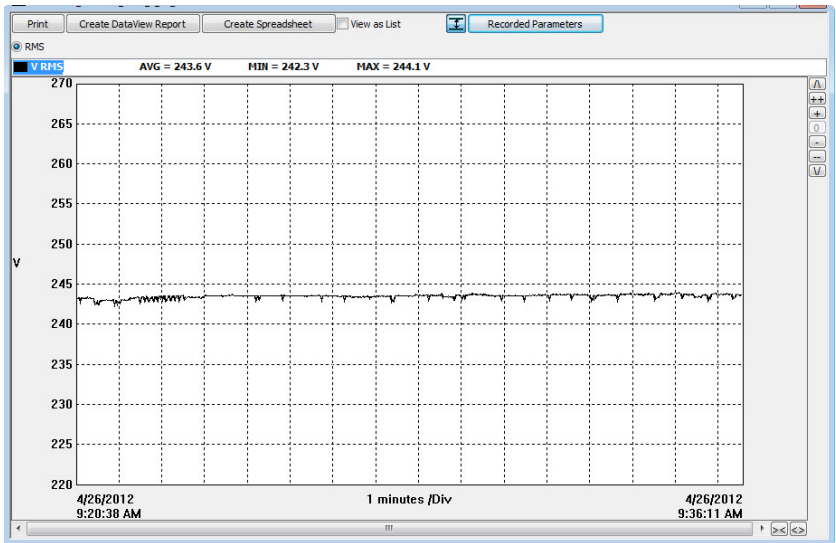

- The Start Date and Time of the recording can also be modified using the **Recording Parameters** button.

3.27 POWER CLAMP METER TEMPLATE

Refer to the DataView® Help files for detailed information about using the templates.

607 Template

The Trend Summary Report template generates a view with a worksheet for each recorded parameter and a cover page.

You can move between the worksheets by selecting the desired worksheet from the worksheet tabs at the bottom of the view (just above the status bar).

The first worksheet is the Cover Sheet and provides information about the recording session. The following illustrates the Cover Sheet:

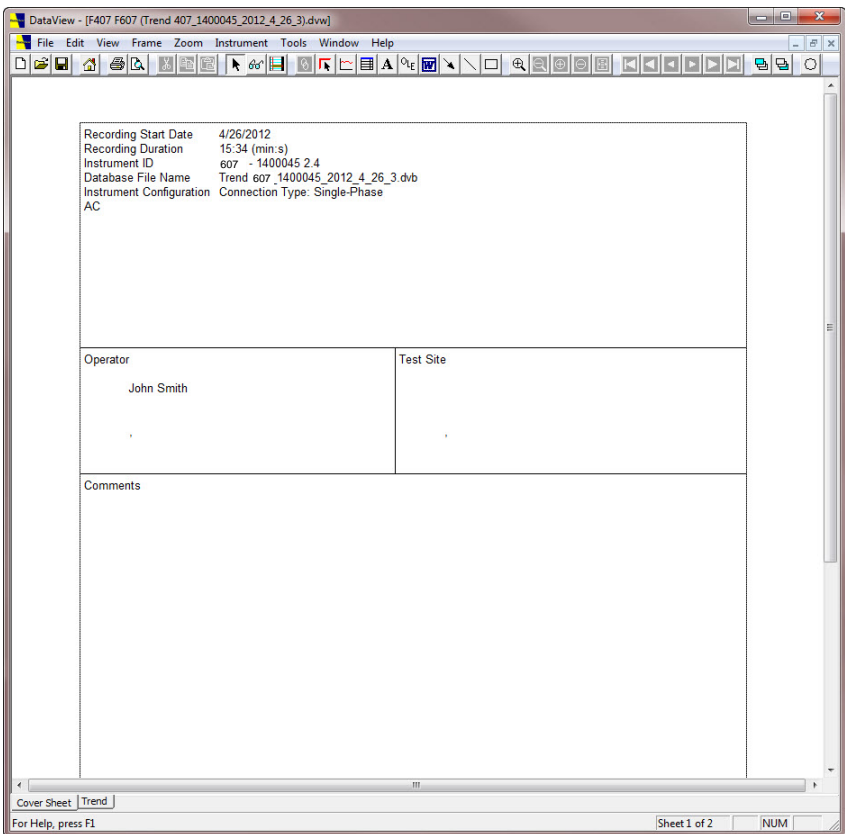

The Cover Sheet is used as a cover sheet for the report and contains the following frames:

- **Text Box** - containing the text "Trend Summary Report".
- **Session Summary** - containing the name of the database used to generate the report.
- **Session Summary** - containing operator information.
- **Session Summary** - containing test site information.
- **Session Summary** - containing operator comments.
- **OLE** - containing the AEMC[®] Instruments logo.

Using the associated properties window customizes each of these frames. The properties window for a frame is displayed by selecting the frame, then selecting the Properties command from the Frame menu.

The next few worksheets are used to view the recorded trend channels and contains the following frames:

- Channel List
- Channel Graph
- Trend Summary
- Meter

The following figure illustrates the Trend List worksheet.

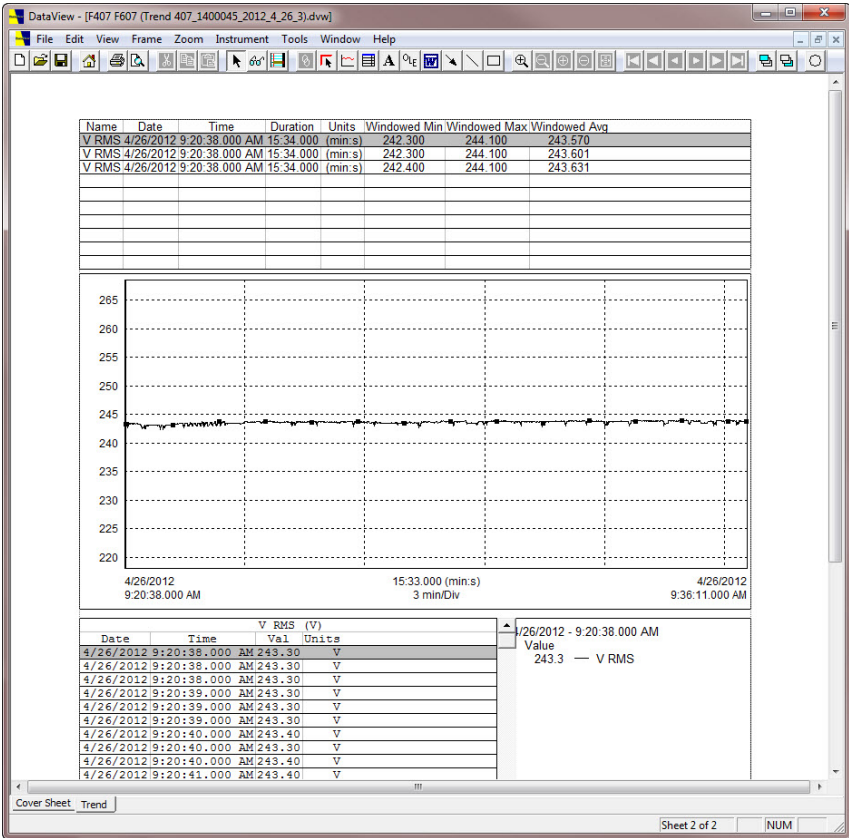

Channel Graph Frame

A Channel Graph frame provides a graphical look into the database it is attached to. The database is attached to the Trend Graph frame when it is created. This can be done manually by placing a graph frame or automatically when using a template.

The graph frame provides additional tools for viewing the underlying database. These tools provide zoom and pan operations. In addition, individual traces and waveform snapshots can be selected using the Select Frame tool.

Normally, the Select Frame tool is used to select a frame for modification. In addition to selecting the Graph frame, this tool is used to select individual traces. A trace is selected if any part of it is drawn within a few screen pixels of where the selection tool is when the left mouse button is pressed.

When a trace is selected, handles similar to those of the frame handles are drawn over the trace. If more than one trace is drawn within the proximity of the selection tool, when clicked again, the next trace will be selected. This will continue until all traces within the selection tools proximity have been selected.

At which point, clicking the left mouse button again will select the first trace and the process will repeat.

Frames can be linked together so that when you select a trace or line in one frame another frame shows additional information about the selection. For example when selecting a trace in the graph the trend summary list will be updated to list the sample points for the selected trace.



Linking frames can create a complex interaction between frames. For additional information refer to the DataView® users guide accessible from the help menu of the main DataView® application.

This template contains the following linked frame types:

- Session Summary
- Channel List
- Meter
- Trend Summary List

The channels selected for display and the display properties can be changed at any time using the Channel Graph Properties window. The Channel Graph Properties window can be displayed by right-clicking the mouse pointer while positioned over the Graph frame, then selecting Properties from the pop-up menu.

The display extents of the Channel Graph frame can be changed by using zoom and pan operations. By zooming and panning you change the starting and ending times of the displayed data. By changing the starting and ending display times, you can zoom in, zoom out, pan left and right, pan to start and pan to the end of the measurement data.

To change the display extents of a graph frame, select the frame using either the frame selection tool  or Zoom Tool . Next, use a zoom or pan command from the Zoom menu, or from the toolbar. By clicking and dragging the Zoom Tool across the desired area of the graph, you can select an area to zoom in on.

Channel List Frame

The Channel List frame is a frame attached to either a Channel Graph or Micro-Graph frame. In the case of this template, the parent is a Channel Graph frame. The Channel List frame displays a textual list summary of the channels available in the recording. Each summary line contains user-specified parameters of a specific channel recording.

You can specify the displayed parameters and general display options using the **Channel List Properties** dialog box.

You can step between list entries. Selecting **Pan To Start**, displays the first list entry. Selecting **Pan To End**, displays the last list entry. Selecting the **Step Right** or **Step Left**, displays the next or previous list entry. When stepping through the

list entries, the selection will move from each entry for the associated channel.

In addition to stepping through the list with the tool bar, you can select a specific entry listed using the mouse pointer. The text for the selected entry will be highlighted, indicating which entry in the list is currently selected.

Session Summary Frame

The Session Summary frame is a frame attached to the Channel Graph frame. This frame displays a textual summary of its parent frame. You can customize the summary text displayed, using the **Session Summary Properties** dialog box. This dialog box is displayed by right-clicking on the frame and selecting **Properties** from the pop-up menu, or by double-clicking on the frame.

The Trend template contains Session Summary frames displaying the following information:

- Start time and duration of the recorded data and the instrument's identification codes. This frame is in the upper right corner of the first worksheet.
- Database containing the file name and location of the recording data
- Operator information
- Test site information
- Operator comments

The text displayed in the session summary frames is static as long as the data within the associated database remains static. Session Summary frames do not provide the interactive operations available in the Channel Graph and Trend Summary List frames.

Meter Frame

The Meter frame is a frame linked to the Channel Graph frame. The Meter frame displays the values of samples at a specific location on the graph. Left-clicking on the graph displays a black vertical bar. The sample values displayed in the meter frame are associated with the time at the location of this vertical bar. Left-clicking at other areas of the graph will move the vertical bar and update the Meter frame accordingly.

Text Box Frame

A Text Box frame displays text at a given location on the page. The text within the frame is static, in that it does not change. It only changes when you change it. This template contains a Text Box located at the top of the worksheet. The text displayed within this frame is the title of this report (Trend Summary Report). The text, font and other frame properties can be changed using the **Text Box Properties** dialog box.

4 SPECIFICATIONS

4.1 REFERENCE CONDITIONS

Quantities of Influence	Reference Conditions
Temperature:	23°C ±2°C
Relative humidity:	45% to 75%
Supply voltage:	6.0V ±0.5V
Frequency range of the applied signal:	45 to 65Hz
Sine wave:	pure
Peak factor of the applied alternating signal:	√2
Position of the conductor in the clamp:	centered
Adjacent conductors:	none
Alternating magnetic field:	none
Electric field:	none

4.2 SPECIFICATIONS UNDER THE REFERENCE CONDITIONS

Accuracy is expressed in ± (x% of the reading (R) + y counts (ct)).

4.2.1 DC Voltage Measurement

Measurement Range	0.00 to 99.99V	100.0 to 999.9V	1000V (1)
Specified Measurement Range	0 to 100% of the measurement range		
Accuracy	0.00 to 9.99V ± (1% R +10cts) 10.00 to 99.99V ± (1% R +3cts)	± (1% R +3cts)	
Resolution	0.01V	0.1V	1V
Input Impedance	10MΩ		

Note (1) Above 1000V, a repetitive beep indicates that the voltage being measured is greater than the safety voltage for which the device is guaranteed. The display indicates "OL".

4.2.2 AC Voltage Measurement

Measurement Range	0.15 to 99.99V	100.0 to 999.9V	1000V RMS 1400V peak (1)
Specified Measurement Range (2)	0 to 100% of the measurement range		
Accuracy	0.15 to 9.99V ± (1% R +10cts) 10.00 to 99.99V ± (1% R +3cts)	± (1% R +3cts)	
Resolution	0.01V	0.1V	1V
Input Impedance	10MΩ		

Note (1) Above 1000V (RMS), a repetitive beep indicates that the voltage being measured is greater than the safety voltage for which the device is guaranteed. The display indicates "OL".

- Bandwidth in AC = 3 kHz

Note (2) Any value between zero and the min. threshold of the measurement range (0.15V) is forced to show "----" on the display.

Specific Specifications in MAX/MIN mode (from 10Hz to 1kHz, and from 0.30V in AC):

- Accuracy: add 1% R to the values of the table above.
- Capture of the extreme: approximately 100ms.

4.2.3 AC+DC Voltage Measurement

Measurement Range (2)	0.15 to 99.99V	100.0 to 999.9V	1000V RMS (1) 1400V peak
Specified Measurement Range	0 to 100% of the measurement range		
Accuracy	0.15 to 9.99V ± (1% R +10cts) 10 to 99.99V ± (1% R +3cts)	± (1% R +3cts)	
Resolution	0.01V	0.1V	1V
Input impedance	10MΩ		

Note (1) The display indicates "OL" above 1000V (1400V in PEAK mode). Above 1000V (DC or RMS), a repetitive beep indicates that the voltage being measured is greater than the safety voltage for which the device is guaranteed.

- Bandwidth in AC = 3 kHz

Note (2) Any value between zero and the min. threshold of the measurement range (0.15V) is forced to "----" on the display.

**Specific Specifications in MAX/MIN mode in Voltage
(from 10Hz to 1kHz in AC and AC+DC):**

- Accuracy: add 1% R to the values of the previous table.
- Capture of the extreme: approximately 100ms.

**Specific Specifications in PEAK mode in voltage
(from 10Hz to 1kHz in AC and AC+DC):**

- Accuracy: add 1.5% R to the values in the previous table.
- PEAK capture time: 1ms min. to 1.5ms max.

4.2.4 DC Current Measurement

Measurement Range (2)	0.00 to 99.99A	100.0 to 999.9A	1000 to 3000A (1)
Specified Measurement Range	0 to 100% of the measurement range		
Accuracy (2) (zero corrected)	$\pm (1\% R + 10\text{cts})$	$\pm (1\% R + 3\text{cts})$	2000A $\pm (1.5\% R + 3 \text{ pt})$ 2000 to 2500A _{DC} $\pm (2.5\% R + 3 \text{ pt})$ 2500 to 3000A _{DC} $\pm (3.5\% R + 3 \text{ pt})$
Resolution	0.01A	0.1A	1A

Note (1) The display indicates “+OL” above 3000A.

Note (2) The residual current at zero depends on the remanence. It can be corrected by the “DC zero” function of the HOLD button.

4.2.5 AC Current Measurement

Measurement Range (2)	0.15 to 99.99A	100.0 to 999.9A	1000 to 2000A (1)
Specified Measurement Range	0 to 100% of the measurement range		
Accuracy	$\pm (1\% R + 10\text{cts})$	$\pm (1\% R + 3\text{cts})$	1000 to 1500A $\pm (1.5\% R + 3\text{cts})$ 1500 to 2000A $\pm (2\% R + 5\text{cts})$
Resolution	0.01A	0.1A	1A

Note (1) The display indicates "OL" above 3000A (in PEAK mode). The "-" and "+" signs are not managed.
- Bandwidth in AC = 1 kHz

Note (2) In AC, any value between zero and the min. threshold of the measurement range (0.15A) is forced to show “----” on the display.
- Residual current at zero <150mA.

4.2.6 AC+DC Intensity Measurement

Measurement Range (2)	0.15 to 99.99A	100.0 to 999.9A	AC: 1000 to 2000A DC or PEAK: 1000 to 3000A (1)
Specified Measurement Range	0 to 100% of the measurement range		
Accuracy (2) (zero corrected)	$\pm (1\% R + 10\text{cts})$	$\pm (1\% R + 3\text{cts})$	2000A $\pm (1.5\% R + 3\text{cts})$ 2000 to 2500A _{DC} $\pm (2.5\% R + 3\text{cts})$ 2500 to 3000A _{DC} $\pm (3.5\% R + 3\text{cts})$
Resolution	0.01A	0.1A	1A

Note (1) The display indicates "+OL" above 3000A (in PEAK mode). The "-" and "+" signs are not managed.

- Bandwidth in AC = 1 kHz

Note (2) In AC, any value between zero and the min. threshold of the measurement range (0.15A) is forced to show "----" on the display.

- Residual current at zero:
- In DC: depends on the remanence. This can be corrected by the "DC zero" function of the HOLD button
- In AC: <150mA

Specific Specifications in MAX/MIN mode (from 10Hz to 1kHz in AC and AC+DC):

- Accuracy: add 1% R to the values of the table above.
- Capture of the extreme: approximately 100ms.

Specific characteristics in PEAK mode in current (from 10Hz to 400Hz in AC and AC+DC):

- Accuracy: add 1.5% R to the values in the tables above.
- PEAK capture time: 1ms min. to 1.5ms max.

4.2.7 True Inrush[®] Measurement

Measurement Range	20 to 2000AAC	20 to 3000ADC
Specified Measurement Range	0 to 100% of the measurement range	
Accuracy	$\pm (5\% R + 5\text{cts})$	
Resolution	1A	

Specific Specifications in PEAK mode in True InRush[®] (from 10Hz to 1kHz in AC):

- Accuracy: add $\pm (1.5\% R + 0.5A)$ to the values in the table above.
- PEAK capture time: 1ms min. to 1.5ms max.

4.2.8 Calculation of the crest factor (CF)

Measurement range	1.00 to 3.50	3.51 to 5.99	6.00 to 10.00
Specified Measurement Range (from 5V or 5A)	0 to 100% of the measurement range		
Accuracy (zero corrected in ADC)	$\pm (2\% R + 2\text{cts})$	$\pm (5\% R + 2\text{cts})$	$\pm (10\% R + 2\text{cts})$
Resolution	1ct		

NOTE: Peak values limited to 1500V or 3000A

4.2.9 Calculation of the RIPPLE in DC

Measurement range	0.1 to 99.9%	100.0 to 1000%
Specified Measurement Range (from 3ADC and 2VDC)	2 to 100% of the measurement range	0 to 100% of the measurement range
Accuracy	$\pm (5\% R + 10\text{cts})$	
Resolution	0.1	

NOTE: If one of the terms for the calculation of the RIPPLE is displayed as "OL", or forced to zero, the RIPPLE displayed is an indeterminate value, "----".

4.2.10 Continuity Measurement

Measurement Range	0.0 to 999.9 Ω
Open-circuit Voltage	$\leq 3.6\text{V}$
Measurement Current	550 μA
Accuracy	$\pm (1\% R + 5\text{cts})$
Buzzer Triggering Threshold	40 Ω

4.2.11 Resistance Measurement

Measurement Range (1)	0.0 to 999.9 Ω	1000 to 9999 Ω	10.00 to 99.99k Ω
Specified Measurement Range	1 to 100% of the measurement range	0 to 100% of the measurement range	
Accuracy	$\pm (1\% R + 5\text{cts})$		
Resolution	0.1 Ω	1 Ω	10 Ω
Open-circuit Voltage	$\leq 3.6\text{V}$		
Measurement Current	550 μA	100 μA	10 μA

Note (1) Above the maximum display value, the display unit indicates "OL". The "-" and "+" signs are not managed.

Specific Specifications in MAX/MIN mode:

- Accuracy: add 1% R to the values of the previous table
- Capture of the extreme: approximately 100ms.

4.2.12 Active DC Power Measurements

Measurement Range (2)	0 to 9999W	10.00 to 99.99kW	100.0 to 999.9kW	1000 to 3000kW (1)
Specified Measurement Range	1 to 100% of the measurement range	0 to 100% of the measurement range		
Accuracy (3)	1000A ± (2% R +10cts) 1000 to 2000A ± (2.5% R +10cts) 2000 to 2500A _{DC} ± (3.5% R +10cts) 2500 to 3000A _{DC} ± (4.5% R +10cts)	1000A ± (2% R +3cts) 1000 to 2000A ± (2.5% R +3cts) 2000 to 2500A _{DC} ± (3.5% R +3cts) 2500 to 3000A _{DC} ± (4.5% R +3cts)		
Resolution	1W	10W	100W	1000W

Note (1) - Display of OL or ± OL

- Above 3000kW in single-phase (1000V x 3000A).

Note (2) Any applied voltage greater than 1000V causes the emission of an intermittent alarm beep to report a dangerous overload.

Note (3) The measurement result may be affected by an instability linked to the current measurement (approximately 0.1A).

Example: For a power measurement made at 10A, the instability of the measurement will be 0.1A/10A or 1%.

4.2.13 Active AC Power Measurements

Measurement Range (2) (4)	5 to 9999W	10.00 to 99.99kW	100.0 to 999.9kW	1000kW (1)
Specified Measurement Range	1 to 100% of the measurement range	0 to 100% of the measurement range		
Accuracy (3)	1000A ± (2% R +10cts)	1000A ± (2% R +3cts)		
Resolution	1W	10W	100W	1000W

Note (1) - Display of OL above 2000kW in single-phase (1000V x 3000A).

- Bandwidth in AC in voltage = 3 kHz, in current = 1 kHz

Notes (2) and (3) of the previous § apply.

Note (4) Any power measured less than 5W is regarded as zero and causes the display of dashes "----"
 If the voltage is less than 0.15V or if the current is less than 0.15A, the power measured is regarded as zero and causes the display of "----"

Note 5 The active powers are positive for power consumed and negative for power generated.

Note 6 The signs of the active and reactive powers and power factor are defined by the four-quadrant rule:
 The diagram below sums up the signs of the power as a function of the phase angle between V and I:

- | | |
|----------------------------|--------------------------|
| Quadrant 1: Active power P | sign + (power consumed) |
| Quadrant 2: Active power P | sign - (power generated) |
| Quadrant 3: Active power P | sign - (power generated) |
| Quadrant 4: Active power P | sign + (power consumed) |

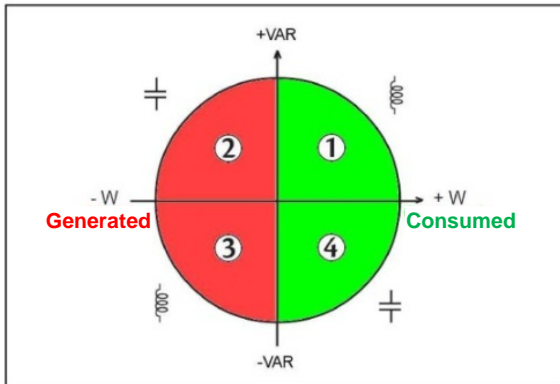

Note (7) In balanced three-phases, with deformed signals (THD and harmonics), uncertainties are guaranteed since $\Phi > 30^\circ$. Additional errors are following, depending of THD:

- Add +1% for $10\% < THD < 20\%$
- Add +3% for $20\% < THD < 30\%$
- Add +5% for $30\% < THD < 40\%$

4.2.14 Active AC+DC Power Measurements

Measurement Range (2) (4)	5 to 9999W	10.00 to 99.99kW	100.0 to 999.9kW	1000 to 3000kW (1)
Specified Measurement Range	1 to 100% of the measurement range	0 to 100% of the measurement range		
Accuracy (3)	1000A ± (2% R +10cts) 1000 to 2000A ± (2.5% R +10cts) 2000 to 2500A _{DC} ± (3.5% R +10cts) 2500 to 3000A _{DC} ± (4.5% R +10cts)	1000A ± (2% R +3cts) 1000 to 2000A ± (2.5% R +3cts) 2000 to 2500A _{DC} ± (3.5% R +3cts) 2500 to 3000A _{DC} ± (4.5% R +3cts)		
Resolution	1W	10W	100W	1000W

Note (1) - Display of OL above 3000kW in single-phase (1000V x 3000A)
- Bandwidth in AC in voltage = 3 kHz, in current = 1 kHz

Notes (2), (3), (4), (5) (6) and (7) of the previous § apply

4.2.15 Measurement of Apparent AC Power

Measurement Range (2) (4)	5VA to 9999VA	10.00kVA to 99.99kVA	100.0kVA to 999.9kVA	1000 kVA to 2000 kVA (1)
Specified Measurement Range	1 to 100% of the measurement range	0 to 100% of the measurement range		
Accuracy (3)	1000A ± (2% R +10cts) 1000 to 2000A ± (2.5% R +10cts)	1000A ± (2% R +3cts) 1000 to 2000A ± (2.5% R +3cts)		
Resolution	1VA	10VA	100VA	1000VA

Note (1) - Display of O.L above 2000 kVA in single-phase (1000V x 2000A).
- Bandwidth in AC in voltage = 3 kHz, in current = 1 kHz

Notes (2), (3) and (4) of the previous § apply

4.2.16 Measurement of Apparent AC+DC Power

Measurement Range (2) (4)	5 to 9999VA	10.00 to 99.99kVA	100.0 to 999.9kVA	1000 to 3000kVA (1)
Specified Measurement Range	1 to 100% of the measurement range	0 to 100% of the measurement range		
Accuracy (3)	1000A ± (2% R +10cts) 1000 to 2000A ± (2.5% R +10cts) 2000 to 2500A _{DC} ± (3.5% R +10cts) 2500 to 3000A _{DC} ± (4.5% R +10cts)	1000A ± (2% R +3cts) 1000 to 2000A ± (2.5% R +3cts) 2000 to 2500A _{DC} ± (3.5% R + 3cts) 2500 to 3000A _{DC} ± (4.5% R + 3cts)		
Resolution	1VA	10VA	100VA	1000VA

Note (1) - Display of OL above 3000 kVA in single-phase (1000V x 3000A).
- Bandwidth in AC in voltage = 3 kHz, in current = 1 kHz

Notes (2), (3) and (4) of the previous § apply

4.2.17 Measurement of Reactive AC Power

Measurement Range (2) (4)	5 to 9999 var	10.00 to 99.99 kvar	100.0 to 999.9 kvar	1000 to 2000 kvar (1)
Specified Measurement Range	1 to 100% of the measurement range	0 to 100% of the measurement range		
Accuracy (3) (7)	1000A ± (2% R +10cts) 1000 to 2000A ± (2.5% R +10cts)	1000A ± (2% R +3cts) 1000 to 2000A ± (2.5% R +3cts)		
Resolution	1 var	10 var	100 var	1 kvar

Note (1) - Display of OL above 2000 kvar in single-phase (1000V x 2000A).
- Bandwidth in AC in voltage = 3 kHz, in current = 1 kHz

Notes (2), (3) and (4) of the previous § apply

Note 5 In single-phase, the sign of the reactive power is determined by the phase lead or lag between the V and I signs, while in balanced three-phase, it is determined by the calculation on the samples.

Note 6 - Signs of reactive powers according to the four-quadrant rule (§4.2.12):
 Quadrant 1: Reactive power Q sign +
 Quadrant 2: Reactive power Q sign +
 Quadrant 3: Reactive power Q sign -
 Quadrant 4: Reactive power Q sign -

Note (7) Measurement stabilization ~8 sec

4.2.18 Measurement of Reactive AC+DC Power

Measurement Range (2) (4)	5 to 9999 var	10.00 to 99.99 kvar	100.0 to 999.9 kvar	1000 to 3000 kvar (1)
Specified Measurement Range	1 to 100% of the measurement range	0 to 100% of the measurement range		
Accuracy (3) (7)	1000A ± (2% R +10cts) 1000 to 2000A ± (2.5% R +10cts) 2000 to 2500A _{DC} ± (3.5% R+10cts) 2500 to 3000A _{DC} ± (4.5% R+10cts)	1000A ± (2% R +3cts) 1000 to 2000A ± (2.5% R +3cts) 2000 to 2500A _{DC} ± (3.5% R+3cts) 2500 to 3000A _{DC} ± (4.5% R+3cts)		
Resolution	1 var	10 var	100 var	1 kvar

Note (1) - Display of OL above 3000 kvar in single-phase (1000V x 3000A).
- Bandwidth in AC in voltage = 3 kHz, in current = 1 kHz

Notes (2), (3), (4), (5), (6) and (7) of the previous § apply

Specific characteristics in MAX/MIN mode in power (from 10Hz to 1kHz in AC and AC+DC):

- Accuracy: add 1% R to the values in the table above.
- Capture time: approximately 100ms

4.2.19 Calculation of the Power Factor (PF)

Measurement Range (1)	0.00 to +1.00	
Specified Measurement Range	0 to 50% of the measurement range	50 to 100% of the measurement range
Accuracy (2)	± (3% R +3cts)	± (2% R +3cts)
Resolution	0.01	

Note (1) If one of the terms in the calculation of the power factor is displayed as "OL", or forced to zero, the display of the power factor is an indeterminate value "----".

Note (2) In balanced three-phases, with deformed signals (THD and harmonics), uncertainties are guaranteed since $\Phi > 30^\circ$. Additional errors are following, depending of THD:

- Add +1% for $10\% < THD < 20\%$
- Add +3% for $20\% < THD < 30\%$
- Add +5% for $30\% < THD < 40\%$

NOTE: The PF is always positive

Specific characteristics in MAX/MIN mode (from 10Hz to 1kHz):

- Accuracy: add 1% R to the values in the table above.
- Capture time: approximately 100ms.

4.2.20 Calculation of the Displacement Power Factor (DPF)

Measurement Range (1)	0.00 to +1.00
Specified measurement Range (from 1AAC)	0 to 100% of the measurement range
Accuracy (2) (3)	$\pm (5\% R + 2\text{cts})$
Resolution	0.01

Note (1) If one of the terms in the calculation of the DPF is displayed as "OL", or forced to zero, the display of the DPF is an indeterminate value "----".

Note (2) of the previous § apply

Note (3) Measurement stabilization ~8 sec

NOTE: The DPF is always positive. It's equivalent to $|\cos \Phi|$

Specific characteristics in MAX/MIN mode (from 10Hz to 1kHz):

- Uncertainties: add 1% R to the values in the table above.
- Capture time: approximately 100ms.

4.2.21 Frequency Measurements

4.2.21.1 Voltage

Measurement Range (1)	5.0 to 999.9Hz	1000 to 9999Hz	10.00 to 19.99kHz
Specified Measurement Range	1 to 100% of the measurement range	0 to 100% of the measurement range	
Accuracy	$\pm (0.4\% R + 1\text{ct})$		
Resolution	0.1Hz	1Hz	10Hz

4.2.21.2 Current

Measurement Range (1)	5.0 to 1999Hz
Specified Measurement Range	1 to 100% of the measurement range
Accuracy	$\pm (0.4\% R + 1\text{ct})$
Resolution	0.1Hz

Note (1) In MAX/MIN mode, the operating range is limited to 1kHz.
If the level of the signal is too low (<10% of the range, or $V < 8V$ or $I < 9A$) or if the frequency is less than 5Hz, the device cannot determine the frequency and displays "----".

Specific Specifications in MAX/MIN mode (from 10Hz to 1kHz):

- Accuracy: add 1% R to the values of the table above.
- Capture of the extreme: approximately 100ms.

4.2.22 Specifications in THDr

Measurement Range	0.0 to 100%
Specified Measurement Range	0 to 100% of the measurement range
Accuracy	$\pm (5\% R \pm 2\text{cts})$ in voltage $\pm (5\% R \pm 5\text{cts})$ in current
Resolution	1%

4.2.23 Specifications in THDf

Measurement Range	0.0 to 1000%
Specified Measurement Range	0 to 100% of the measurement range
Accuracy	$\pm (5\% R \pm 2\text{cts})$ in voltage $\pm (5\% R \pm 5\text{cts})$ in current
Resolution	1%

Note : The display is "----" if the input signal is too low ($V < 8V$ or $I < 9A$) or if the frequency is less than 5Hz.

Specific characteristics in MAX/MIN mode in THD (from 10Hz to 1kHz):

- Accuracy: add 1% R to the values in the table above.
- Capture of the extreme: approximately 100ms

4.2.24 Harmonic Measurement Specifications

Measurement Range in Voltage	Per §4.2.2 and §4.2.3
Measurement Range in Current	Per §4.2.5 and §4.2.6
Harmonic Range	AC: harmonics of orders 1 to 25 AC+DC: all orders from 1 to 25, plus the DC component
Frequency Analysis Band	- 0 to 25 times the fundamental frequency, from among the network frequencies 50, 60, and 400Hz - 0 to 12 times the fundamental frequency of an 800Hz network
Stability of the Current and Voltage Display	$\pm (1\% R \pm 2\text{cts})$
Accuracy on the RMS value of the harmonic (zero corrected in Abc)	Level >10% and order <13: $\pm(5\% R \pm 2\text{cts})$ Level >10% and order >13: $\pm(10\% R \pm 2\text{cts})$ Level <10% and order <13: $\pm(10\% R \pm 2\text{cts})$ Level <10% and order >13: $\pm(15\% R \pm 2\text{cts})$

Note: The display is "----" if the input signal is too low ($U < 8V$ or $I < 9A$) or if the frequency is less than 5Hz.

- Specific characteristics in MAX/MIN mode in THD (from 10Hz to 1kHz):

- Accuracy: add 1% R to the values in the tables above.
- Capture time of the extreme: approximately 100ms

4.3 ENVIRONMENTAL CONDITIONS

Conditions	Operating	Storage
Temperature	-4° to +131°F (-20° to +55°C)	-40° to +158°F (-40° to +70°C)
Relative humidity (RH)	≤90% up to 131°F (55°C)	≤90% up to 158°F (70°C)

4.4 MECHANICAL SPECIFICATIONS

Housing	Rigid polycarbonate shell with over-molded elastomer covering; UL94 V1
Jaws	Polycarbonate Opening: 2.36" (60mm) Clamping diameter: 2.36" (60mm)
Screen	LCD display unit Blue backlighting Dimension: 1.6 x 1.9" (41 x 48mm)
Dimension	11.65 x 4.37 x 1.61" (296 x 111 x 41mm)
Weight	1.4 lbs (640g) with batteries



4.5 POWER SUPPLY

Batteries	4x1.5V AA LR6
Battery Life	>350 hours (without backlighting and Bluetooth)
Auto Power Off	After 10 minutes with no switch and/or button activity

4.6 COMPLIANCE WITH INTERNATIONAL STANDARDS

Electric safety	Compliant with standards IEC-61010-1, IEC-61010-2-30, and IEC-61010-2-32: 1000V CAT IV.
Electromagnetic compatibility	Compliant with standard EN-61326-1 Classification: residential environment
Mechanical strength	Free fall: 2m (in accordance with standard IEC-68-2-32)
Level of protection of the housing	Housing: IP54 (per standard IEC-60529) Jaws: IP40

4.7 ENVIRONMENTAL VARIATIONS

Condition of influence	Range of influence	Measurement influenced	Influence	
			Typical	MAX
Temperature	-4° to +131°F (-20 to +55°C)	V AC V DC A* Ω  W AC W DC	- 0.1% R/10°C 1% R/10°C* - - 0.15% R/10°C	0.1% R/10°C 0.5% R/10°C + 2cts 1.5% R/10°C + 2cts* 0.1% R/10°C + 2 cts 0.2% R/10°C + 2 cts 0.3% R/10°C + 2 cts
Humidity	10% to 90%RH	V A Ω  W	≤ 1 ct - 0.2% R 0.25% R	0.1R + 1 ct 0.1% R + 2 cts 0.3% R + 2 cts 0.5% R + 2 cts
Frequency	10 Hz to 1 kHz 1 kHz to 3 kHz 10 Hz to 400 Hz 400 Hz to 1 kHz	V A	1% R + 1 ct 8% R + 1 ct 1% R + 1 ct 4% R + 1 ct	1% R + 1 ct 9% R + 1 ct 1% R + 1 ct 5% R + 1 ct
Position of the conductor in the jaws (f≤400 Hz)	Any position on the internal perimeter of the jaws	A-W (<2000A DC or 1400A AC) (>2000A DC)	2% R 8% R	4% R + 1 ct Full-scale
Adjacent conductor carrying a current of 150 A DC or RMS	Conductor touching the external perimeter of the jaws	A-W	40 dB	30 dB
Conductor enclosed by the clamp	0 to 500 A DC or RMS	V	< 1 ct	1 ct
Application of a voltage of the clamp	0 to 1000 V DC or RMS	A-W	< 1 ct	1 ct
Peak factor (1)	1.4 to 3.5 limited to 3000 A peak 1400 V peak	A (AC-AC+DC) V (AC-AC+DC)	1% R 1% R	3% R + 1 ct 3% R + 1 ct
PF (inductive and capacitive)	0.7 and I ≥ 5A 0.5 and I ≥ 10A 0.2 and I ≥ 20A	W	0.5%R	1% R + 1 ct 3% R + 1 ct 8% R + 1 ct

*Note in Temperature: Influence specified until 1000 A DC

5 MAINTENANCE

5.1 WARNING:

- Remove the test leads on any input before opening the case.
- Do not operate the clamp-on meter without a battery case cover.
- To avoid electrical shock, do not attempt to perform any servicing unless you are qualified to do so.
- To avoid electrical shock and/or damage to the instrument, do not get water or other foreign agents into the probe.

5.2 CLEANING

- Disconnect everything connected to the device and set the switch to OFF.
- Use a soft cloth moistened with soapy water. Rinse with a damp cloth and dry quickly using a dry cloth or forced air.
- Dry completely before putting back into use.

5.3 REPLACEMENT OF THE BATTERIES

The  symbol indicates that the batteries are low. When this symbol appears on the display unit, the batteries must be replaced. The measurements and specifications are no longer guaranteed.

To replace the batteries, proceed as follows:

1. Disconnect the measurement leads from the input terminals.
2. Set the switch to OFF.
3. Using a screwdriver, unscrew the battery compartment cover from the back of the housing (see §3.1).
4. Remove the used batteries and replace them with 4x1.5V AA batteries, observing the polarities.
5. Close the battery compartment cover and screw it onto the housing.

6 REPAIR AND CALIBRATION

To ensure that your instrument meets factory specifications, we recommend that it be submitted to our factory Service Center at one-year intervals for recalibration, or as required by other standards or internal procedures.

For instrument repair and calibration:

You must contact our Service Center for a Customer Service Authorization number (CSA#). This will ensure that when your instrument arrives, it will be tracked and processed promptly. Please write the CSA# on the outside of the shipping container. If the instrument is returned for calibration, we need to know if you want a standard calibration, or a calibration traceable to N.I.S.T. (includes calibration certificate plus recorded calibration data).

Chauvin Arnoux[®], Inc. d.b.a. AEMC[®] Instruments
15 Faraday Drive
Dover, NH 03820 USA
Tel: (800) 945-2362 (Ext. 360)
(603) 749-6434 (Ext. 360)
Fax: (603) 742-2346 or (603) 749-6309
repair@aemc.com

(Or contact your authorized distributor)

Costs for repair, standard calibration, and calibration traceable to N.I.S.T. are available.

NOTE: All customers must obtain a CSA# before returning any instrument.

7 TECHNICAL AND SALES ASSISTANCE

If you are experiencing any technical problems, or require any assistance with the proper operation or application of your instrument, please call, mail, fax or e-mail our technical support hotline:

Chauvin Arnoux[®], Inc. d.b.a. AEMC[®] Instruments
200 Foxborough Boulevard
Foxborough, MA 02035, USA
Phone: (800) 343-1391
(508) 698-2115
Fax: (508) 698-2118
techsupport@aemc.com
www.aemc.com

NOTE: Do not ship instruments to our Foxborough, MA address.

8 LIMITED WARRANTY

The Model 607 is warranted to the owner for a period of three years from the date of original purchase against defects in manufacture. This limited warranty is given by AEMC® Instruments, not by the distributor from whom it was purchased. This warranty is void if the unit has been tampered with, abused or if the defect is related to service not performed by AEMC® Instruments.

Full warranty coverage and product registration is available on our website at www.aemc.com/warranty.html.

Please print the online Warranty Coverage Information for your records.

If a malfunction occurs within the three-year period, you may return the instrument to us for repair, provided we have your warranty registration information on file or a proof of purchase. AEMC® Instruments will, at its option, repair or replace the faulty material.

REGISTER ONLINE AT: www.aemc.com

9 WARRANTY REPAIRS

What you must do to return an Instrument for Warranty Repair:

First, request a Customer Service Authorization Number (CSA#) by phone or by fax from our Service Department (see address below), then return the instrument along with the signed CSA Form. Please write the CSA# on the outside of the shipping container. Return the instrument, postage or shipment pre-paid to:

Chauvin Arnoux®, Inc. d.b.a. AEMC® Instruments
15 Faraday Drive • Dover, NH 03820 USA
Tel: (800) 945-2362 (Ext. 360)
(603) 749-6434 (Ext. 360)
Fax: (603) 742-2346 or (603) 749-6309
repair@aemc.com

Caution: To protect yourself against in-transit loss, we recommend you insure your returned material.

NOTE: All customers must obtain a CSA# before returning any instrument.



Chauvin Arnoux[®], Inc. d.b.a AEMC[®] Instruments
15 Faraday Drive • Dover, NH 03820 USA
www.aemc.com